

**Data Sheet | Item Number: 2000-5372/1102-953**  
 3-conductor sensor supply terminal block; LED (green); 1 mm<sup>2</sup>; Push-in CAGE CLAMP®; 1,00 mm<sup>2</sup>; orange

<https://www.wago.com/2000-5372/1102-953>

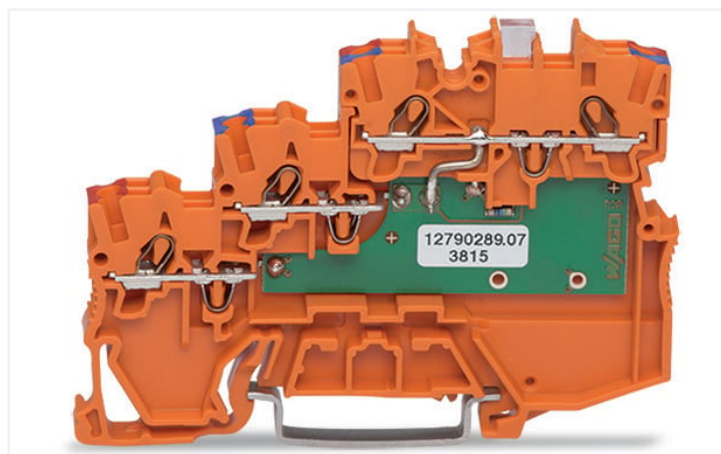

Color: ■ orange

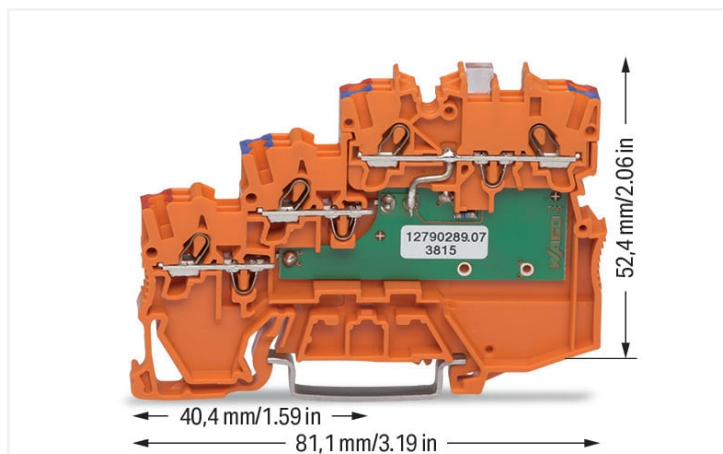
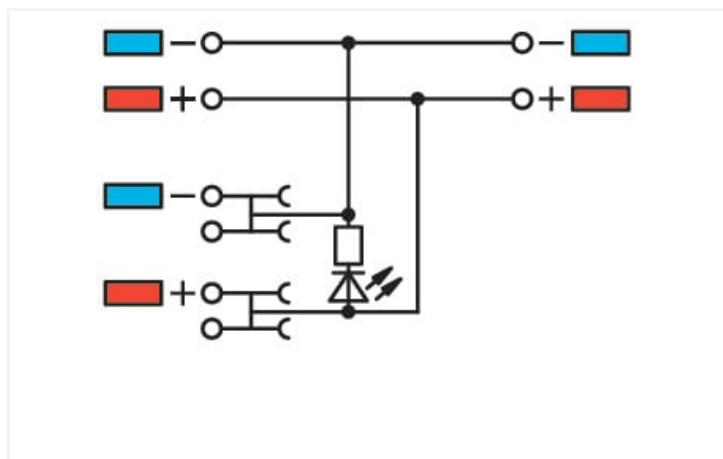

3.5 mm spacing per signal (2 x 3.5 mm = 7 mm)

The double spacing per pole of this terminal block series maximizes connectivity. For example, ten sensors may be connected using only five sensor terminal blocks plus a power supply terminal block.

**Electrical data**

Ratings per	IEC/EN 60947-7-1		
Overvoltage category	III	III	II
Pollution degree	3	2	2
Nominal voltage	-	-	-
Rated surge voltage	-	-	-
Rated current	-	-	-

Approvals per	UL 1059		
Use group	B	C	D
Rated voltage	24 V	-	24 V
Rated current	15 A	-	15 A

Approvals per	CSA 22.2 No 158		
Use group	B	C	D
Rated voltage	-	24 V	-
Rated current	-	10 A	-

Power Loss	
Power loss, per pole (potential)	0.4338 W
Rated current I <sub>N</sub> for specified power loss	13.5 A
Resistance value for specified, current-dependent power loss	0.00238 Ω

### General information

Voltage type 1	DC
Nominal voltage	24 V

### Connection data

Connection points	8
Total number of potentials	4
Number of levels	3
Number of jumper slots	3
Number of jumper slots (rank)	2

### Connection 1

Connection technology	Push-in CAGE CLAMP®
Actuation type	Operating tool
Connectable conductor materials	Copper
Nominal cross-section	1 mm <sup>2</sup>
Solid conductor	0.14 ... 1.5 mm <sup>2</sup> / 24 ... 16 AWG
Solid conductor; push-in termination	0.5 ... 1.5 mm <sup>2</sup> / 20 ... 16 AWG
Fine-stranded conductor	0.14 ... 1.5 mm <sup>2</sup> / 24 ... 16 AWG
Fine-stranded conductor; with insulated ferrule	0.14 ... 0.75 mm <sup>2</sup> / 24 ... 18 AWG
Fine-stranded conductor; with ferrule; push-in termination	0.5 ... 0.75 mm <sup>2</sup> / 20 ... 18 AWG
Note (conductor cross-section)	Depending on the conductor characteristic, a conductor with a smaller cross-section can also be inserted via push-in termination.
Strip length	9 ... 11 mm / 0.35 ... 0.43 inches
Wiring direction	Front-entry wiring

### Physical data

Width	7 mm / 0.276 inches
Height	81.1 mm / 3.193 inches
Depth from upper-edge of DIN-rail	52.4 mm / 2.063 inches

### Mechanical data

Mounting type	DIN-35 rail
Marking level	Center/side marking

### Material data

Note (material data)	<a href="https://www.wago.com/us/material-specifications">Information on material specifications can be found here</a>
Color	orange
Material group	I
Insulation material	Polyamide (PA66)
Flammability class per UL94	V0
Fire load	0.278 MJ
Weight	16 g

### Environmental requirements

Processing temperature	-35 ... +85 °C
Continuous operating temperature	-60 ... +105 °C

### Commercial data

eCl@ss 10.0	27-14-11-28
eCl@ss 9.0	27-14-11-28
ETIM 8.0	EC000900
ETIM 7.0	EC000900
PU (SPU)	15 pcs
Packaging type	Box
Country of origin	DE
GTIN	4055143452335
Customs tariff number	85369010000

### Environmental Product Compliance

RoHS Compliance Status	Compliant, No Exemption
------------------------	-------------------------

### Approvals / Certificates

#### General approvals



Approval	Standard	Certificate Name
CCA DEKRA Certification B.V.	EN 60947	NTR NL 7962
CSA DEKRA Certification B.V.	C22.2	2130762
KEMA/KEUR DEKRA Certification B.V.	EN 60947	71-125928
UL Underwriters Laboratories Inc.	UL 1059	E45172

#### Declarations of conformity and manufacturer's declarations



Approval	Standard	Certificate Name
EU-Declaration of Confor- mity WAGO GmbH & Co. KG	-	-
Railway WAGO GmbH & Co. KG	-	Railway Ready
UK-Declaration of Confor- mity WAGO GmbH & Co. KG	-	-

### Downloads

#### Environmental Product Compliance

##### Compliance Search

Environmental Product  
Compliance  
2000-5372/1102-953



## Documentation

### Additional Information

Technical Section	pdf 2240.62 KB	<a href="#">↓</a>
-------------------	-------------------	-------------------

### Bid Text

2000-5372/1102-953	07.08.2018	docx 14.93 KB	<a href="#">↓</a>
2000-5372/1102-953	19.02.2019	xml 3.88 KB	<a href="#">↓</a>

## CAD/CAE-Data

### CAD data

2D/3D Models 2000-5372/1102-953	<a href="#">↓</a>
------------------------------------	-------------------

### CAE data

EPLAN Data Portal 2000-5372/1102-953	<a href="#">↓</a>
ZUKEN Portal 2000-5372/1102-953	<a href="#">↓</a>

## 1 Compatible Products

### 1.1 Required Accessories

#### 1.1.1 End plate

##### 1.1.1.1 End plate



**Item No.: 2000-5391**

End and intermediate plate; 1 mm thick; for 3-conductor terminal blocks; gray

### 1.2 Optional Accessories

#### 1.2.1 DIN-rail

##### 1.2.1.1 Mounting accessories



**Item No.: 210-196**

Aluminum carrier rail; 35 x 8.2 mm; 1.6 mm thick; 2 m long; unslotted; similar to EN 60715; silver-colored



**Item No.: 210-198**

Copper carrier rail; 35 x 15 mm; 2.3 mm thick; 2 m long; unslotted; according to EN 60715; copper-colored



**Item No.: 210-197**

Steel carrier rail; 35 x 15 mm; 1.5 mm thick; 2 m long; slotted; similar to EN 60715; silver-colored



**Item No.: 210-114**

Steel carrier rail; 35 x 15 mm; 1.5 mm thick; 2 m long; unslotted; similar to EN 60715; silver-colored



**Item No.: 210-118**

Steel carrier rail; 35 x 15 mm; 2.3 mm thick; 2 m long; unslotted; according to EN 60715; silver-colored



**Item No.: 210-115**

Steel carrier rail; 35 x 7.5 mm; 1 mm thick; 2 m long; slotted; according to EN 60715; "Hole width 18 mm; silver-colored



**Item No.: 210-112**

Steel carrier rail; 35 x 7.5 mm; 1 mm thick; 2 m long; slotted; according to EN 60715; "Hole width 25 mm; silver-colored



**Item No.: 210-113**

Steel carrier rail; 35 x 7.5 mm; 1 mm thick; 2 m long; unslotted; according to EN 60715; silver-colored

## 1.2.2 Ferrule

### 1.2.2.1 Ferrule



**Item No.: 216-241**

Ferrule; Sleeve for 0.5 mm<sup>2</sup> / 20 AWG; insulated; electro-tin plated; electrolytic copper; gastight crimped; acc. to DIN 46228, Part 4/09.90; white



**Item No.: 216-242**

Ferrule; Sleeve for 0.75 mm<sup>2</sup> / 18 AWG; insulated; electro-tin plated; electrolytic copper; gastight crimped; acc. to DIN 46228, Part 4/09.90; gray



**Item No.: 216-243**

Ferrule; Sleeve for 1 mm<sup>2</sup> / AWG 18; insulated; electro-tin plated; electrolytic copper; gastight crimped; acc. to DIN 46228, Part 4/09.90; red

## 1.2.3 Installation

### 1.2.3.1 Cover



**Item No.: 709-156**

Cover; Type 3; suitable for cover carrier, type 3; 1 m long; transparent

### 1.2.3.2 Cover carrier



**Item No.: 709-169**

Cover carrier; Type 3; incl. fixing/retaining screws and knurled nut; suitable for 279 to 282 and 880 Series rail-mounted terminal blocks; suitable for 264 Series miniature rail-mounted terminal blocks; suitable for 270 Series sensor and actuator terminal blocks; gray

## 1.2.4 Jumper

### 1.2.4.1 Jumper



**Item No.: 2000-406/020-000**

Delta jumper; insulated; light gray



**Item No.: 2000-410/000-006**

Jumper; 10-way; insulated; blue



**Item No.: 2000-410**

Jumper; 10-way; insulated; light gray



**Item No.: 2000-410/000-005**

Jumper; 10-way; insulated; red



**Item No.: 2000-402/000-006**

Jumper; 2-way; insulated; blue



**Item No.: 2000-402**

Jumper; 2-way; insulated; light gray



**Item No.: 2000-402/000-005**

Jumper; 2-way; insulated; red



**Item No.: 2000-402/000-018**

Jumper; 2-way; insulated; yellow-green



**Item No.: 2000-403/000-006**

Jumper; 3-way; insulated; blue



**Item No.: 2000-403**

Jumper; 3-way; insulated; light gray



**Item No.: 2000-403/000-005**

Jumper; 3-way; insulated; red



**Item No.: 2000-404/000-006**

Jumper; 4-way; insulated; blue



**Item No.: 2000-404**

Jumper; 4-way; insulated; light gray



**Item No.: 2000-404/000-005**

Jumper; 4-way; insulated; red



**Item No.: 2000-405/000-006**

Jumper; 5-way; insulated; blue



**Item No.: 2000-405**

Jumper; 5-way; insulated; light gray



**Item No.: 2000-405/000-005**

Jumper; 5-way; insulated; red



**Item No.: 2000-406/000-006**

Jumper; 6-way; insulated; blue



**Item No.: 2000-406**

Jumper; 6-way; insulated; light gray



**Item No.: 2000-406/000-005**

Jumper; 6-way; insulated; red



**Item No.: 2000-407/000-006**

Jumper; 7-way; insulated; blue



**Item No.: 2000-407**

Jumper; 7-way; insulated; light gray



**Item No.: 2000-407/000-005**

Jumper; 7-way; insulated; red



**Item No.: 2000-408/000-006**

Jumper; 8-way; insulated; blue

1.2.4.1 Jumper



**Item No.: 2000-408**  
Jumper; 8-way; insulated; light gray



**Item No.: 2000-408/000-005**  
Jumper; 8-way; insulated; red



**Item No.: 2000-409/000-006**  
Jumper; 9-way; insulated; blue



**Item No.: 2000-409**  
Jumper; 9-way; insulated; light gray



**Item No.: 2000-409/000-005**  
Jumper; 9-way; insulated; red



**Item No.: 2000-440**  
Jumper; from 1 to 10; insulated; light gray



**Item No.: 2000-433/000-006**  
Jumper; from 1 to 3; insulated; blue



**Item No.: 2000-433**  
Jumper; from 1 to 3; insulated; light gray



**Item No.: 2000-433/000-005**  
Jumper; from 1 to 3; insulated; red



**Item No.: 2000-434**  
Jumper; from 1 to 4; insulated; light gray



**Item No.: 2000-435**  
Jumper; from 1 to 5; insulated; light gray



**Item No.: 2000-436**  
Jumper; from 1 to 6; insulated; light gray



**Item No.: 2000-437**  
Jumper; from 1 to 7; insulated; light gray



**Item No.: 2000-438**  
Jumper; from 1 to 8; insulated; light gray



**Item No.: 2000-439**  
Jumper; from 1 to 9; insulated; light gray



**Item No.: 2000-405/011-000**  
Star point jumper; 3-way; insulated; light gray



**Item No.: 210-103**  
Wire commoning chain; insulated; black



**Item No.: 210-123**  
Wire commoning chain; insulated; blue

1.2.5 Marking

1.2.5.1 Marker



**Item No.: 793-3501**  
WMB marking card; as card; plain; snap-on type; white



**Item No.: 2009-113/000-006**  
WMB-Inline; for Smart Printer; 2300 pieces on roll; plain; snap-on type; blue



**Item No.: 2009-113/000-007**  
WMB-Inline; for Smart Printer; 2300 pieces on roll; plain; snap-on type; gray



**Item No.: 2009-113/000-023**  
WMB-Inline; for Smart Printer; 2300 pieces on roll; plain; snap-on type; green



**Item No.: 2009-113/000-017**  
WMB-Inline; for Smart Printer; 2300 pieces on roll; plain; snap-on type; light green



**Item No.: 2009-113/000-012**  
WMB-Inline; for Smart Printer; 2300 pieces on roll; plain; snap-on type; orange



**Item No.: 2009-113/000-005**  
WMB-Inline; for Smart Printer; 2300 pieces on roll; plain; snap-on type; red



**Item No.: 2009-113/000-024**  
WMB-Inline; for Smart Printer; 2300 pieces on roll; plain; snap-on type; violet



**Item No.: 2009-113**  
WMB-Inline; for Smart Printer; 2300 pieces on roll; plain; snap-on type; white



**Item No.: 2009-113/000-002**  
WMB-Inline; for Smart Printer; 2300 pieces on roll; plain; snap-on type; yellow

1.2.5.2 Marker carrier



**Item No.: 2000-121**  
Adaptor; gray

1.2.5.3 Marking strip



**Item No.: 2009-110**  
Marking strips; for Smart Printer; on reel; not stretchable; plain; snap-on type; white

## 1.2.6 Protective warning marker

### 1.2.6.1 Cover



**Item No.: 2000-115**

Protective warning marker; for 5 terminal blocks; with high-voltage symbol, black; yellow

## 1.2.7 Push-in type wire jumper

### 1.2.7.1 Jumper



**Item No.: 2009-404**

Push-in type wire jumper; 0.75 mm<sup>2</sup>; insulated; 110 mm long; gray



**Item No.: 2009-406**

Push-in type wire jumper; 0.75 mm<sup>2</sup>; insulated; 250 mm long; gray



**Item No.: 2009-402**

Push-in type wire jumper; 0.75 mm<sup>2</sup>; insulated; 60 mm long; gray

## 1.2.8 Screwless end stop

### 1.2.8.1 Mounting accessories



**Item No.: 249-117**

Screwless end stop; 10 mm wide; for DIN-rail 35 x 15 and 35 x 7.5; gray



**Item No.: 249-116**

Screwless end stop; 6 mm wide; for DIN-rail 35 x 15 and 35 x 7.5; gray

## 1.2.9 Test and measurement

### 1.2.9.1 Testing accessories



**Item No.: 2009-174**

Test plug adapter; for 4 mm Ø test plugs; for testing TOPJOB®S rail-mounted terminal blocks; gray



**Item No.: 2009-182**

Testing tap; for max. 2.5 mm<sup>2</sup>; tool-free connection for individual test wires 0.08 - 2.5 mm; gray

## 1.2.10 Tool

### 1.2.10.1 Operating tool



**Item No.: 210-719**

Operating tool; Blade: 2.5 x 0.4 mm; with a partially insulated shaft



**Item No.: 210-648**

Operating tool; Blade: 2.5 x 0.4 mm; with a partially insulated shaft; angled; short



**Item No.: 210-647**

Operating tool; Blade: 2.5 x 0.4 mm; with a partially insulated shaft; multicoloured

## Installation Notes

### Conductor termination

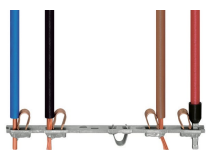

All conductor types at a glance

### Commoning

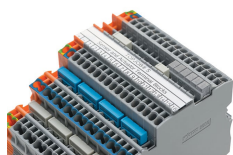

**Commoning (signal level):**  
Commoning the signal level with push-in type jumper bars (2000 Series). Models with an LED can only be commoned in one jumper slot!  
TOPJOB® S Test Plug Adapters can be used in all jumper slots.



**Upper level:** Two independent signal pathways

### Commoning

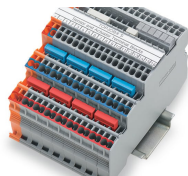

**Commoning (potential level):**  
Commoning potential levels via push-in type jumper bars (2000 Series).

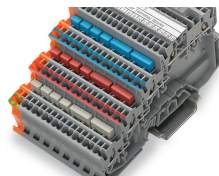

**Commoning (potential level):**  
Continuous commoning in the potential levels via push-in type jumper bars for even pole numbers (2000 Series)



**Potential levels:** Two adjacent commoning options on a current bar

### Commoning

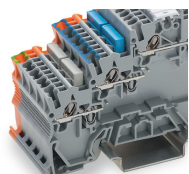

**Ground commoning:**  
For sensor and actuator terminal blocks without ground connection to the DIN-rail, the ground connection can be performed by commoning to the terminal block with a ground foot.



For example, colored push-in type jumper bars are used with sensor terminal blocks.



## Testing

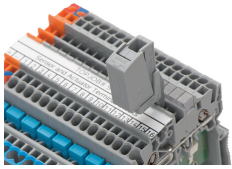

Testing via testing tap (2009-182) (up to max. 42 V).

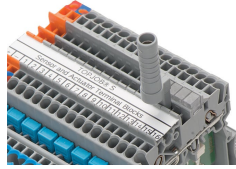

Testing via testing tap (2009-174) (up to max. 42 V).

## Application

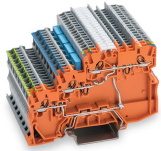

### Supply:

Orange supply terminal block of same profile with a power supply option from both the cabinet and sensor sides

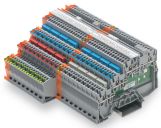

Terminal block assembly with 4-conductor sensor terminal blocks and 3-conductor actuator terminal blocks

## Marking

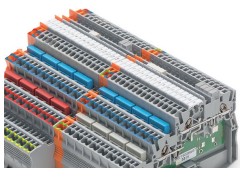

### Marking:

3.5 mm WMB markers (793-35xx) from the top or the side – additional marking option via marker carrier

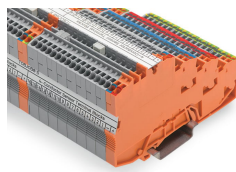

### Marking:

Labeling via marking strips (2009-110) – from the top or the side.