

Operating instructions

Clock thermostat



MTC
optimising controller

1 Table of contents

OPERATING INSTRUCTIONS	1
CLOCK THERMOSTAT	1
1 TABLE OF CONTENTS	2
2 DESIGNATED USE	2
2.1 SAFETY	3
3 DESCRIPTION OF THE THERMOSTAT	3
3.1 CONCISE SPECIFICATIONS	3
3.2 TECHNICAL SPECIFICATIONS	3
4 MOUNTING AND ELECTRICAL CONNECTION	3
4.1 MOUNTING	3
4.2 ELECTRICAL CONNECTION	4
4.3 ONE HEATER ON ONE CONTROLLER	4
4.4 SEVERAL UNITS ON 1 THERMOSTAT	4
5 SETTINGS	5
5.1 LANGUAGE	5
5.2 TIME/DATE	5
5.3 TEMPERATURES	5
5.4 CLOCK PROGRAM	5
5.5 HEATING PROGRAM	6
6 VENTILATION	6
7 OVERTIME TIMER	6
8 OPTIMISER	7
9 KEYBOARD LOCKING	7
10 DISPLAY	7
11 CALIBRATING THE THERMOSTAT	7
12 DESTRATIFICATION (DELAT T REGULATION)	8
13 BACK TO FACTORY DEFAULT SETTINGS	8
14 REMOTE SENSOR	8
14.1 ELECTRICAL CONNECTION:	8
14.2 SETTING THE CONTROLLER FOR THE REMOTE SENSOR	9
14.3 AVERAGE TEMPERATURES	9
14.4 ERRORS WITH THE REMOTE SENSOR	9
15 OPTIONAL EXTERNAL INPUT	9
16 SOLVING AND ANALYSING FAILURES	9
17 OBTAINING EXTRA INFORMATION FROM THE CONNECTED HEATERS	10
18 INSTALLER MENU	11
19 INTERNAL BATTERY	11
20 MAINTENANCE AND SERVICE	12

2 Designated use

The Multi Therm-C clock thermostat has been designed to control room heaters that work according to the Argus bus system. This is a two-wire low voltage communication system. The thermostat is not suitable to switch 24V, 230V or other signals. It may only be used in dry rooms with slight impurities (degree of protection IP30).

Before use, carefully read these operating instructions and observe them. In case the mounting and operating instructions are not observed, the manufacturer's warranty will not apply to any resulting damage.

2.1 Safety

Electrical devices may only be connected by a qualified electrician. Always observe the relevant national regulations. Interferences and changes to the device will lead to cancellation of the warranty.

3 Description of the thermostat

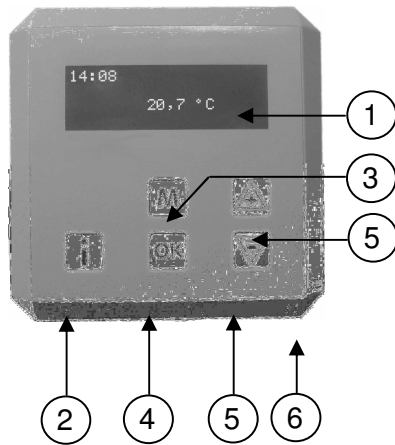

1. Display
2. Info button to display information
3. Menu button to enter and exit the menu
4. OK button to confirm a setting
5. + and – buttons to raise or lower settings
6. openings for the temperature sensor

3.1 Concise specifications

- Room thermostat with clock function
- Optimising controller
- Permanent display of the room temperature
- 10 different programmable time blocks
- Up to 8 heaters controllable
- Frost protection
- Keyboard locking
- Overtime program
- Ventilation
- Failure diagnosis of the devices
- Suppression of interference of the heater
- Compensation for wall influence
- suited for remote sensor
- Supplied battery, excellent for preserving data in case of power failure

3.2 Technical specifications

- Power supply: low-voltage current
- Temperature range: 0-30 degrees Celsius
- Controller: PI
- Clock: 10 programmable switch blocks
- Degree of protection: IP30

4 Mounting and electrical connection

4.1 Mounting

The clock thermostat is suitable for mounting in dry, not too dusty rooms. Place the thermostat in a room in a location where air can circulate unimpeded. Beware that in winter the low-standing sun cannot shine directly onto the thermostat. Placement above or near a device that radiates heat is also not recommended. Avoid placement on a cold outdoor wall; place the thermostat on an indoor wall free of draught. All these things have an

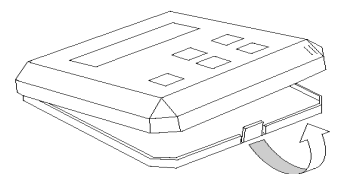

adverse effect on the correct measurement of the room temperature and hence on the proper operation of the thermostat.

By pressing the notch on the bottom of the thermostat, you can open the thermostat. The bottom plate containing the connector can be mounted on a universal wall box or directly on the wall.



Be ware that the controller should not be mounted near a antennas from any internal communication network. These antennas may disturb the correct functioning of the controller. Always keep a few meters distance.



Place the thermostat in a place where you can see the heater(s). When the thermostat is used to reset a heater, the effect must be visible.

4.2 Electrical connection

In all cases the communication between the heater and the thermostat is based on a two wire, low-voltage connection. In the appliance the wire for the thermostat has to be connected to connection 4 and 5 (see also electrical wiring diagram).



Connect the thermostat wires to the connector marked with RT

If the right connector is used the thermostat will become defect.

Cable specification: signal cable, 1x2x0,8 (shielded and twisted)
Maximum length 200m.

If the cable is chosen too thin, the signal will become too poor. If the cable is not shielded and twisted the signal might become disturbed in an EMC unfriendly environment.

Keep the thermostat cable separated from mains cables. Connect the earth shield of the cable only to the earth terminal in the heater.

If these guidelines are not followed it may result in malfunction of the installation or worse, it could damage the thermostat or the electronics in the heater.

4.3 One heater on one controller

Standard nothing needs to be changed in the heating device. In case the thermostat does not work, check that the micro-switches S2 on the print plate in the room heater are set as shown on the right: number 1 up (ON) and the other numbers down. The switch S3 should be set to 1. In case several devices are connected to 1 thermostat, refer to the relevant chapter in this manual.



This thermostat is only suitable for connection to heating devices specifically intended for this purpose. Never connect, for example, 24V or another voltage of another system to the thermostat. This can damage the thermostat. After making the changes inside the heater always unplug and re plug the power to the heater for the changes to become effective.

4.4 Several units on 1 thermostat

The room thermostat can control up to 8 room heaters. Connecting them is simple, but it should be done properly.

Pay attention to the following:

- Each unit must be given its own number (to be set with the micro-switch S2 in the unit).
- One unit must have the S2 number 1 set on ON (this unit provides for the communication) and S3 to 1, all the other heaters should have S3 set to 0.
- Between the separate units, the numbers 4 must be connected with the numbers 4 and the number 5 with 5. They must not be connected in a cross-wise manner.

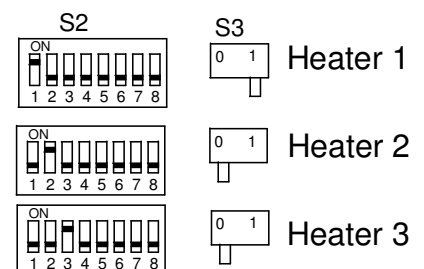

The functionality of the thermostat does not change by connecting a number of room heaters.

beware that the thermostat wires do not run through the same circuit as 230 volt wires and are not parallel with high-voltage current wires.

Cable specification: signal cable, 1x2x0,8 (shielded and twisted)

Maximum length 200m.

If these instructions are not followed the thermostat may be damaged

Communication error: Check Heater address

When the thermostat can not communicate with the heaters the thermostat will show “check Heater address” in the display. In this case the settings of the micro switches in the heater have to be checked.

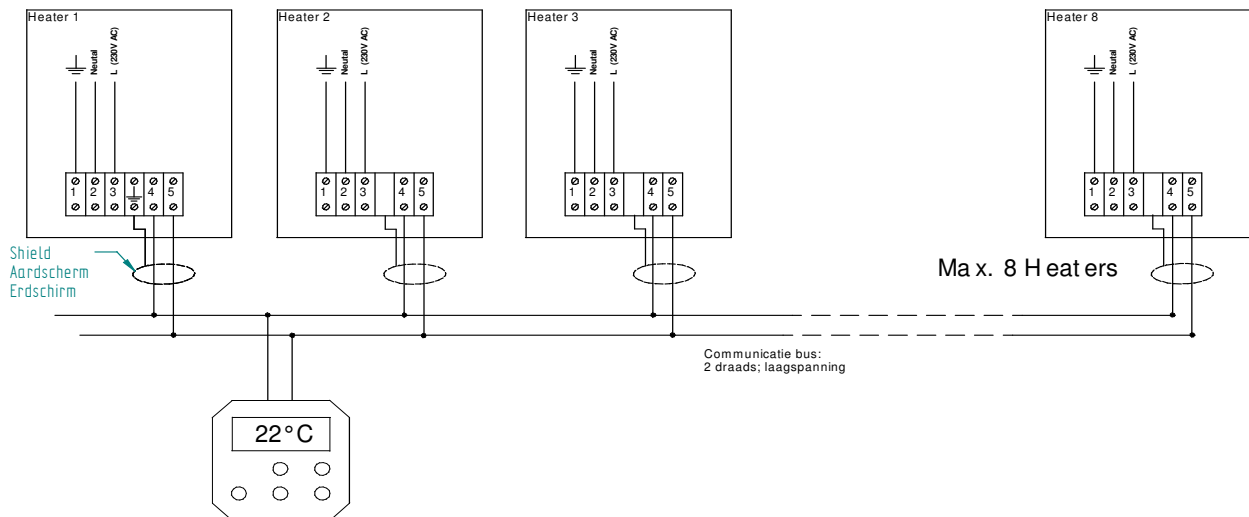

5 Settings

5.1 Language

Menu (M)→Settings→Language

You can change the language of the various menu items of the thermostat. To change the language of the thermostat, Select the language and confirm with OK. Exit the menu by pressing M twice.

5.2 Time/date

Menu (M)→Settings→Time / Date

Set the time and select whether you want to use the Daylight saving time (DST). To exit the menu, press M twice.

```
Time/date
DST ON
Tijd 14:34
Date 10-09-2010 Vr
```

5.3 Temperatures

Menu (M)→Settings→Temperatures

During the clock program, the thermostat works with 3 temperature levels in a room: Day, Night and Frost temperature.

These levels can each be set from 0 to 30 degrees Celsius. This allows you to set the desired temperature quickly when programming the clock program. Set the desired temperatures from 0 to 30°C. Confirm with OK. Exit the menu by pressing M twice.

```
temperatures
day 20°C
night 15°C
frost 6°C
```

Comment. For the sake of ease, the names day, night and frost have been chosen. You are free to set the temperature levels at any desired time and on any desired value between 0 and 30 degrees.

5.4 Clock program

Menu (M)→Settings→Clock program

You can program 10 time blocks in the thermostat.

```
Program Block 1
Mo Tu We Th Fr
07:00 day
17:00 night
```

A time block is for example:

Every Monday at 7.00 day temperature; and at 17.00 night temperature.

Go through the different programmed blocks with the + and – buttons. By pressing OK you can change the selected block.

For days there are various options:

off
Mo Tu We Th Fr Sa Su
Mo Tu We Thu Fr
 Sa Su
Mo
 Tu

Program	Block 1
Off	

And further...

When the block has been filled in correctly, press OK to save the block.

Deleting programmed blocks

When selecting day, you can also select the off option. In that case the settings of the block are deleted.

5.5 Heating program

Menu (M)→Settings→Heating program

This thermostat can work in different ways.

Naturally, it can work automatically on the clock, but also in other ways.

Cont. day The thermostat maintains the programmed day temperature; the temperature is not lowered. However, you can change the temperature manually.

Cont. night The thermostat maintains the programmed night temperature; the temperature is not raised. However, you can change the temperature manually.

Cont. frost The thermostat maintains the programmed frost temperature; the temperature is not raised. However, you can change the temperature manually.

Clock program The thermostat maintains the clock program.
You can still change the set point manually, the set point will return to its automated value at the program step of the clock.

Heating prog
Cont. frost
▶Clock program
Cont. day

Change the settings with the + and – buttons and each time confirm with OK. To exit the menu, press M twice.

6 Ventilation

Menu (M)→Ventilation

With some devices it is possible to control the ventilator without the heater being on. In summer this can, for example, have a cooling effect. The ventilator can be switched to 4 positions: position 1, 2, 3 and off. Setting the ventilation.

Ventilation
Off 1 ▶2 3

Change the settings with the + and – buttons and each time confirm with OK. To exit the menu, press M button.

7 Overtime timer

Menu (M)→Overtime program

When the thermostat is set on the clock and you would like temporarily to maintain the temperature longer on day level, you can do so with the overtime timer. The overtime timer can be set per 15 minutes.

Overtime
01:15

Enter the time, and confirm with OK. The time will start to count down immediately.

8 Optimiser

Menu (M)→Settings→Optimiser

```
Optimiser
On
▶ Off
```

the controller can be set in such a way that it will start the heaters earlier by means of a optimising program. The controller calculates when the heaters should be started in order to reach the set point temperature at the desired time.

the settings with the + and – buttons and each time confirm with OK. To exit the menu, press M twice.

After setting the optimiser it will take several days for the controller to gathered the information needed for the calculations. When the controller is confronted with sudden colder or warmer nights it will not take this in its calculations immediately. When the temperatures are lower for a few days it will adjust its calculations.

Remark: The maximum time that the heaters will start earlier is 3 hours, and the earlier start is not overnight.

9 Keyboard locking

Menu (M)→Settings→Keyboard locking

- Set key lock code
 - Default 0.0.0.0
- On
- Off
- On excl overtime

It may be handy to secure the thermostat in whole or in part against unauthorised changing of the settings.

There are several levels of security:

- Unlocked.
- Fully locked.
- Limited, with only the overtime timer.

The standard unlock code is “0.0.0.0” It can be changed with the option set key lock code.

Overtime

With the option On excl overtime only the overtime program from the thermostat is available, all the other functions are not available.

Unlock

The thermostat can be unlocked by holding the M button for 10 sec. and enter the code.

10 Display

Menu (M)→Settings→Display

The thermostat can arrange the display in various ways.

```
14:06          Disp 1
                21,5 °C
```

```
21.5°C        Disp 2
                14:06
```

```
14:06          Disp 3
                21.5°C
Setpoint       22.0°C
```

Exit by pressing M button

11 Calibrating the thermostat

Menu (M)→Settings→calibration

```
Calibration
Temp. difference
-2,0
```

Under unfavourable circumstances, variations can occur

between the actual temperature and the displayed temperature. This may be caused by assembly to an outdoor wall, irradiation of the sun, monitors, etc. This temperature difference can be compensated for by means of a calibration function.

Example: The difference between the measured value and the displayed value is 2°C, i.e. the displayed value is 2°C too high. The correction value is therefore -2°C.

To exit the menu, press M twice.

12 Destratification (delat T regulation)

Menu (M)→Settings→Delta T active

Warm air wants to go up and stay under the ceiling of the room. The heater has the ability to push this warm air back to the ground, and spread it into the room. This is called destratification or delta T regulation. The thermostat measures the temperature on ground level and reads the temperature above in the room from the sensors on the heater. When the temperature difference between the ceiling and ground level the ventilator inside the heaters will start to push the warm air down. (factory default 12°C. When this regulation is active the heater will also stop to burn until this temperature is leveled.

To exit the menu, press M twice.

In the special installer menu the parameters of this delta T regulations can be changed. For example the temperature difference when the fan should start and stop can be changed. See for this in the chapters from the installer menu.

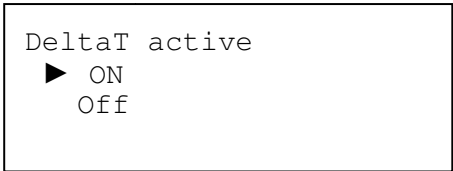

13 Back to factory default settings

In case the thermostat needs to become its factory default settings back it can be done by pressing the OK button for 10 seconds. All settings are lost and the default language menu will show.



14 Remote sensor

In some cases it is applicable that the temperature is measured on another place than the controller is suited. In that case a remote sensor can be plugged on the same 2 wires as the heaters and the controller. The controller then works with the temperature from the separate remote sensor. It is also possible that the controller takes the average between its own internal sensor and the remote sensor.

14.1 ELECTRICAL CONNECTION:

 The sensor should be connected according to the diagram as shown. The sensor is connected through a 2-wire low voltage communication system, the Argus Link. Cable specification: signal cable, 1x2x0,8 (shielded and twisted) Maximum length 200m. If these instructions are not followed the thermostat may be damaged

To connect the sensor, always ensure that the heating device has been shut down. Connect the sensor on the same wires as the clock thermostat. See Figure. Make sure the cable of the thermostat is not parallel to a 230 Volt cable.

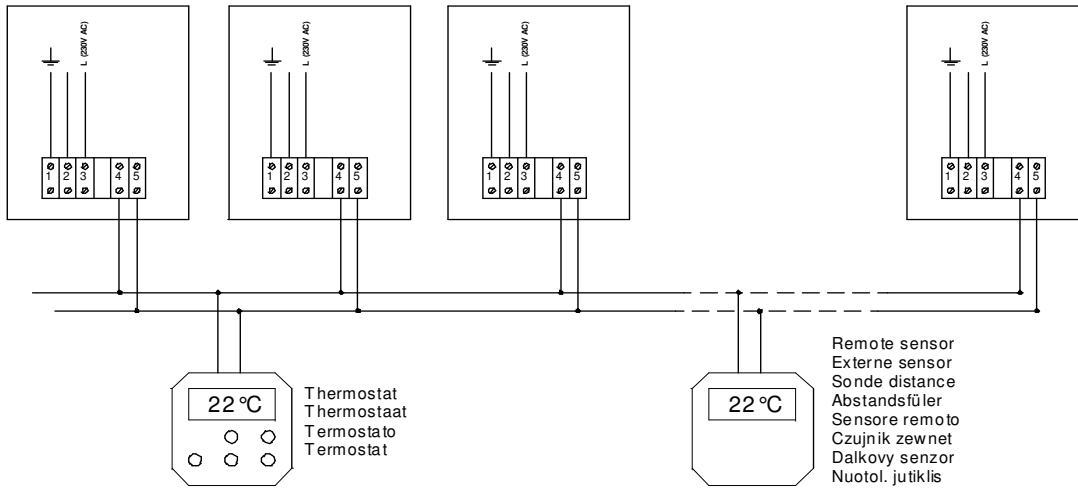

14.2 Setting the controller for the remote sensor

Menu (M) → Installer → PIN[0543] → Remote sensor
Exit the menu by pressing the M button 2 times.

14.3 Average temperatures

The controller can also calculate the average between its internal sensor and the remote sensor. Select the option Average for that.

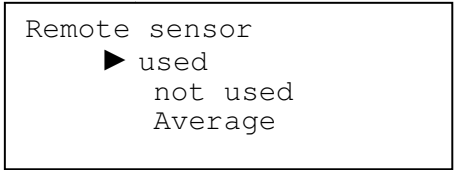

14.4 Errors with the remote sensor

In the case that the controller sees an error regarding the remote sensor it will show an error on the display.
When there is no sensor found it will show error 3
When the sensor is found but is not set up correctly it will show error 4

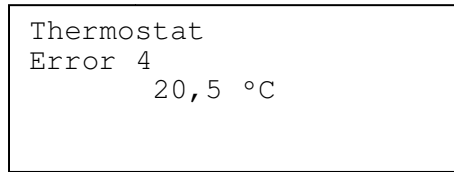

15 Optional external input

With the external input contact a heater can be switched on or off independent from the clock program or temperature. For example

- Heating ON when the contact closes
- Heating OFF when the contact closes

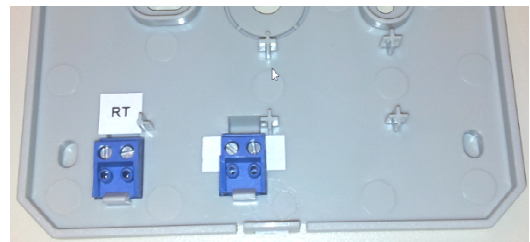
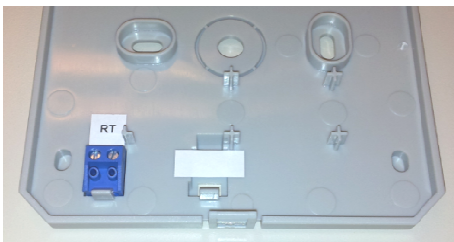

To make the extra inputs available an extra connector needs to be put into the thermostats back. RT is for the thermostat wires to the heaters
The right connector is for the external contact.

Attention while connecting the extra input

The wires from this contact may not be longer than 40cm.

The wires need to be potential free. Never apply any power to these wires, the thermostat will be damaged.

16 Solving and analysing failures

Communication failure: Check Heater Address

The thermostat can not communicate with the heaters.
Check if the dipswitches are set up right.

Error from the heater

When one or more heater(s) has an error message, it appears on the display of the thermostat.

By pressing the Info button, you can obtain more information about the error message. With the + and - buttons, you can select different heaters if connected.

When, for this error message, resetting the room heater is an option, this also appears in the display. You can reset the heater by pressing OK.

NOTE: If a room heater frequently goes on failure, do not continue to reset; this can damage it. Let a recognised installer examine the room heater.

```
Heater Error
20,5 °C
```

```
Heater 1 XR NG ADJ.
Error A1 (1)
IGNIT ERROR
Reset heater
```

17 Obtaining extra information from the connected heaters

When the info button is pressed for 5 seconds a special information menu is showed. By pressing the + or - button the status of all the connected heaters can be checked. By pressing the Info button again more information about the selected heater will appear. The information will be shown in the English language.

To exit the information menu press the M button.

When no heater is found the display will show Heater N.C. not connected

```
Heater 1 N.C.
```

Screen 1

Shows the heater type

```
Heater 1 HA NG 50KW
```

Screen 2

line 1: shows the discription of the connected heater

line 2: shows the status of the heater line 3 and 4: shows the temperatures from the internal sensors.

Ycy = flue temperature if the sensor is fitted (optional)

Ttop: temperature of the air where the heater is located.

Tx1 and Tx2: Temperatures from the sensor mounted on the heatexchanger

```
Heater 1 XR NG 10kW
STANDBY_0
Tcy Ttop 23
Tx1 22 Tx2 22
```

screen 3

line 1: shows the discription of the connected heater

line 2: shows the status of the heater

line 3 and 4:

Ion = ionisation level 0 -90

Ac = actual speed or the burnerfan

Sf = actual modulation level of the system fan 0-255

Mi = minimum speed of the burnerfan

Ig = ignition speed of the burnerfan

Ma = maximum speed of the burnerfan

```
Heater 1 XR NG 10kW
STANDBY_0
Ion 0 Ac 0 SF 0
Mi3480 Ig4740 Ma6000
```

Screen 4

Line 1: Shows the connected heater

Line 2: status

Line 2: Nr of days that the heater is on electric power.

Line 4: Nr of burning hours.

```
Heater 1 HA NG 50KW
BURN_0
Appl.act.days : 15
Burn.act.hours : 25
```

Screen 5

Line 1: Shows the connected heater

Line 2: Nr of success ignitions.

Line 3: Nr of failed ignitions.

Line 4: Nr of flame failures.

```
Heater 1 HA NG 50KW
Ignit.OK : 20
Ignit.failed : 2
Flame failures: 1
```

Screen 6

Shows the last 16 E errors. These errors can reset automatically. The blinking nr is the last error. The CRC code is the software version in the heater.

Heater 1	33	33	42	80
CRC:C04D	42	--	--	--
Blocking	--	--	--	--
History:	--	--	--	--

Screen 7

Shows the last 16 A errors. These errors have to be reset by hand. The blinking nr is the last error. The CRC code is the software version in the heater.

Heater 1	1	1	03	09
CRC:C04D	01	--	--	--
Llocking	--	--	--	--
History:	--	--	--	--

18 Installer menu

Menu (M) →installateur→PIN 0543→

The functioning of the heater and the controller can be changed by changing the parameters in the installer menu.

The following options are available

- Heater modus (modulation from the heater)
 - Heater full (fully modulatin) (Default)
 - Heater high (Only on high position)
 - Heater mid (Only on middle position)
 - Heater low(Only on low position)
 - Heater low&mid (Low and middle position)
 - Heater mid&high (Middle and high position)
- deltaT hysteresse
 - Hystt up 12°C (Value for switching the delta T ON)
 - Hyst down 8°C (value for swiching OFF)
- Delta T2Hystereses (Not used)
 - Hyst up 4°C
 - Hyst down 2°C
- Hystereses (computing value for thermostat)
 - 0,3°C
- I Factor (computing value for thermostat)
 - I 5min
- Delta T2 regeling (not used)
 - ON / OFF
- External sensor
 - ON /OFF / average
- View mode Only
 - ON/OFF

With this option the heat demand from the thermostat is disabled. The thermostat can be uses as a remote status reader. To exit the view mode press the M button 10 seconds and enter the installer menu again.
- External Input
 - Closed=Burn
 - Closed is OFF (standard)

19 Internal battery

When the thermostat is connected to the room heater, it does not use power from the internal battery. This battery only serves to allow the internal clock to run on in case of a power failure. The programmed data always remains in memory. This means that the battery, too, will stand years of use.

When the battery is empty, the clock of the thermostat will be on 00:00 after a power failure of the room heater that has number 1.

If it is necessary to replace the battery: Click the top of the thermostat loose from the wall plate. Use a flat screwdriver for this and push it into the opening on the bottom of the thermostat.

Carefully prise the print plate out of the top of the thermostat using a flat screwdriver. See picture.

Carefully prise the print plate out of the holder (see picture). Then prise the battery out of the holder and insert a new battery. Click the thermostat back together again.

Note: Do not dispose the battery in your regular household waste.

Dispose it separately in accordance with national guidelines.

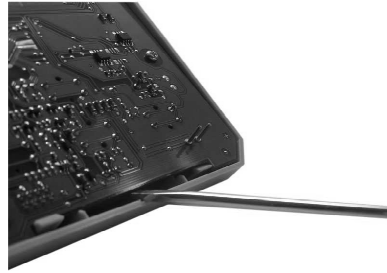

20 Maintenance and service

Under normal use, the thermostat requires no maintenance.

In a very dusty environment it may be necessary to clean the ventilation openings of the temperature sensor.

Clean the device exclusively with a dry or moist lint-free cloth. Beware of moisture inside the device.

Waste processing

At the end of the life cycle, the thermostat should be disassembled by an expert and processed in an environmentally-friendly way in accordance with the relevant national regulations.

Do not dispose the battery in your regular household waste. Dispose it separately in accordance with national guidelines.