

Productinformatieblad

Specificaties



Druknop Ø 60 Ø22mm, Blauw

ZB4BR6

EAN Code: 3389110888522

Prijs: 27,75 EUR

Hoofd

range of product	Harmony XB4
product of component type	Kop voor niet-verlichte drukknoop
device short name	ZB4
kraag materiaal	Verchroomd metaal
bevestigingsdiameter	22 mm
verkoop per ondeelbare hoeveelheid	1
koptype	Standaard
vorm van kop signaleringseenheid	Rond
type operator	terugverend
operator profiel	Blauw paddenstoel Ø 60 mm, niet gemarkeerd
kap/operator of lenskleur	Blauw

Complementair

CAD totale breedte	60 mm
CAD totale hoogte	60 mm
CAD totale diepte	52 mm
mechanical durability	5000000 cycles
elektrische samenstellingscode	C1 voor <9 contacten gebruik enkelvoudig blokken in vooraan gemonteerd C2 voor <9 contacten gebruik enkelvoudig en dubbel blokken in vooraan gemonteerd C11 voor <3 contacten gebruik enkelvoudig blokken in vooraan gemonteerd C15 voor <1 contacten gebruik enkelvoudig blokken in vooraan gemonteerd
product presentatie	Basisonderdeel

Omgeving

beschermende behandeling	TH
ambient air temperature for storage	-40...70 °C
ambient air temperature for operation	-40...70 °C
overvoltage category	Klasse I In overeenstemming met IEC 60536
IP beschermingsgraad	IP66 In overeenstemming met IEC 60529 IP67 IP69 IP69K
NEMA beschermingsgraad	NEMA 13 NEMA 4X

De weergegeven prijs is de adviesprijs in euro excl. BTW. Deze kan onderhevig zijn aan korting. Neem contact op met uw lokale distributeur of detailhandel voor de daadwerkelijke prijs

IK-beschermingsgraad	IK03 In overeenstemming met IEC 50102
standards	EN/IEC 60947-5-1 EN/IEC 60947-5-4 CSA C22.2 Nr 14 EN/IEC 60947-1 EN/IEC 60947-5-5 JIS C8201-5-1 UL 508 JIS C8201-1
product certifications	CSA DNV BV LROS (Lloyds register of shipping) UL listed
trilling bestendigheid	5 gn (f= 2...500 Hz) In overeenstemming met IEC 60068-2-6
schokbestendigheid	30 gn (duur = 18 ms) voor halve sinusgolf versnelling In overeenstemming met IEC 60068-2-27 50 gn (duur = 11 ms) voor halve sinusgolf versnelling In overeenstemming met IEC 60068-2-27

Verpakkingseenheid

Eenheidstype van verpakking 1	PCE
Aantal eenheden in verpakking 1	1
verpakking 1 hoogte	7,0 cm
verpakking 1 breedte	7,0 cm
verpakking 1 lengte	8,8 cm
verpakking_1_gewicht	89,0 g
Eenheidstype van verpakking 2	S02
Aantal eenheden in verpakking 2	20
verpakking 2 hoogte	15,0 cm
verpakking 2 breedte	30,0 cm
verpakking 2 lengte	40,0 cm
verpakking 2 gewicht	2,162 kg

contractuele waarborg

Garantie (in maanden)	18
------------------------------	----

Environmental Data

Schneider Electric wil tegen 2050 de Net Zero-status hebben bereikt via partnerschappen in de toeleveringsketen, materialen met een lagere impact en circulariteit via onze doorlopende campagne "Use Better, Use Longer, Use Again" om de levensduur van producten en de recycleerbaarheid te verlengen.

[Uitleg van Environmental Data](#) >

[Hoe evalueren we de duurzaamheid van producten?](#) >

Milieuoetafdruk

Totale levenscyclus ecologische voetafdruk 1

Milieu Profiel [Milieuprofiel van het product](#)

Use Better

Materialen en verpakking

Pakket met gerecycleerd karton Ja

Verpakkingen zonder kunststof Ja

[EU-richtlijn RoHS](#)

Voldoet pro-actief (Product valt niet onder de EU RoHS juridische scope)

REACH-regelgeving

[REACH-verklaring](#)

Use Again

Herverpakken en herfabriceren

Circulair Profiel [Informatie over einde levensduur](#)

Terugname Ja

Dimensions Drawings

Dimensions

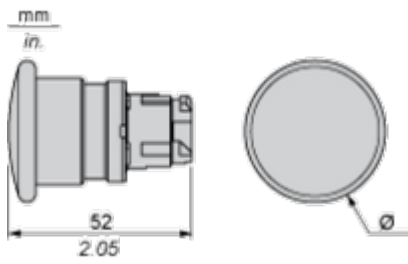

	Ø in mm	Ø in in.
ZB4BC•	40	1.57
ZB4BR•	60	2.36

Mounting and Clearance

Panel Cut-out for Pushbuttons, Switches and Pilot Lights (Finished Holes, Ready for Installation)

Connection by Screw Clamp Terminals or Plug-in Connectors or on Printed Circuit Board	Connection by Faston Connectors
	
<p>(1) Diameter on finished panel or support</p> <p>(2) 40 mm min. / 1.57 in. min.</p> <p>(3) 30 mm min. / 1.18 in. min.</p> <p>(4) $\varnothing 22.5 \text{ mm} / 0.89 \text{ in. recommended } (\varnothing 22.3 \text{ mm }_0^{+0.4} / 0.88 \text{ in. }_0^{+0.016})$</p> <p>(5) 45 mm min. / 1.78 in. min.</p> <p>(6) 32 mm min. / 1.26 in. min.</p>	



A: 1.18 in. min.
 B: 1.57 in. min.

General Tolerances of the Panel and Printed Circuit Board

The cumulative tolerance must not exceed 0.3 mm / 0.012 in: T1 + T2 = 0.3 mm max.

Installation Precautions

- Minimum thickness of circuit board: 1.6 mm / 0.06 in.
- Cut-out diameter: 22.4 mm ± 0.1 / 0.88 in. ± 0.004
- Orientation of body/fixing collar ZB4 BZ009: ± 2° 30' (excluding cut-outs marked a and b).
- Tightening torque of screws ZBZ 006: 0.6 N.m (5.3 lbf.in) max.
- Allow for one ZB4 BZ079 fixing collar/pillar and its fixing screws:
 - every 90 mm / 3.54 in. horizontally (X), and 120 mm / 4.72 in. vertically (Y).
 - with each selector switch head (ZB4 BD*, ZB4 BJ*, ZB4 BG*).

The fixing centers marked a and b are diagonally opposed and must align with those marked 4 and 5.

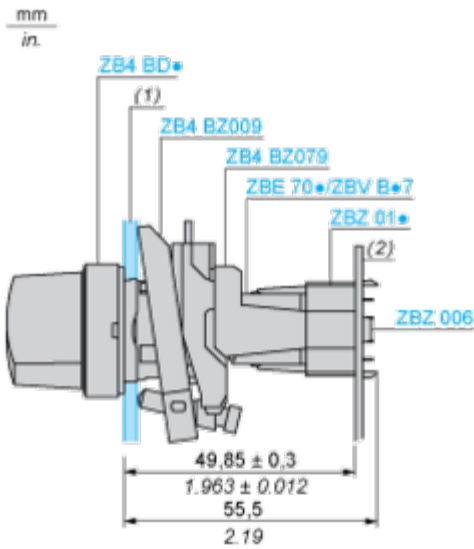

(1) Panel

(2) Printed circuit board

Mounting of Adapter (Socket) ZBZ 01•

- 1 2 elongated holes for ZBZ 006 screw access
- 2 1 hole $\varnothing 2.4 \text{ mm} \pm 0.05 / 0.09 \text{ in.} \pm 0.002$ for centring adapter ZBZ 01•
- 3 $8 \times \varnothing 1.2 \text{ mm} / 0.05 \text{ in.}$ holes
- 4 1 hole $\varnothing 2.9 \text{ mm} \pm 0.05 / 0.11 \text{ in.} \pm 0.002$, for aligning the printed circuit board (with cut-out marked a)
- 5 1 elongated hole for aligning the printed circuit board (with cut-out marked b)
- 6 4 holes $\varnothing 2.4 \text{ mm} / 0.09 \text{ in.}$ for clipping in adapter ZBZ 01•

Dimensions An + 18.1 relate to the $\varnothing 2.4 \text{ mm} \pm 0.05 / 0.09 \text{ in.} \pm 0.002$ holes for centring adapter ZBZ 01•.

Technical Description

Electrical Composition Corresponding to Code C1

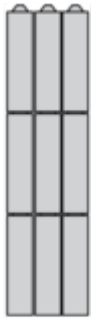

Electrical Composition Corresponding to Code C2



Electrical Composition Corresponding to Codes C9, C11, SF1 and SR1

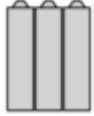

Electrical Composition Corresponding to Code C15

1 N/O



1 N/C

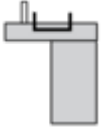

1 N/O + N/C or 1 N/O + N/O or 1 N/C + N/C

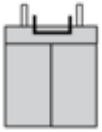

Legend

Single contact



Double contact



Light block



Possible location



Technical Illustration

Dimensions

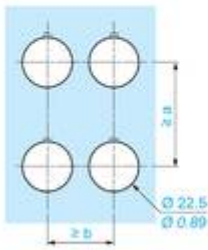
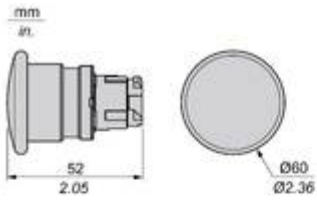

		a (mm)	a (in.)	b (mm)	b (in.)
	ZBE..... ZBV.....	40	1.57	30	1.18
	ZBE.....3 ZBV.....3	45	1.77	32	1.26
	ZBE.....4 ZBV.....4	40	1.57	30	1.18
	ZBE.....5 ZBV.....5	50	1.97	30	1.18
	ZBE.....9 ZBV.....9	40	1.57	30	1.18
	ZBRT... ZBRV1	40	1.57	30	1.18

Image of product / Alternate images

Alternative

