

Data Sheet | Item Number: 745-655/006-000

PCB terminal block; 16 mm²; Pin spacing 20 mm; 5-pole; CAGE CLAMP®; commoning option; gray

<https://www.wago.com/745-655/006-000>

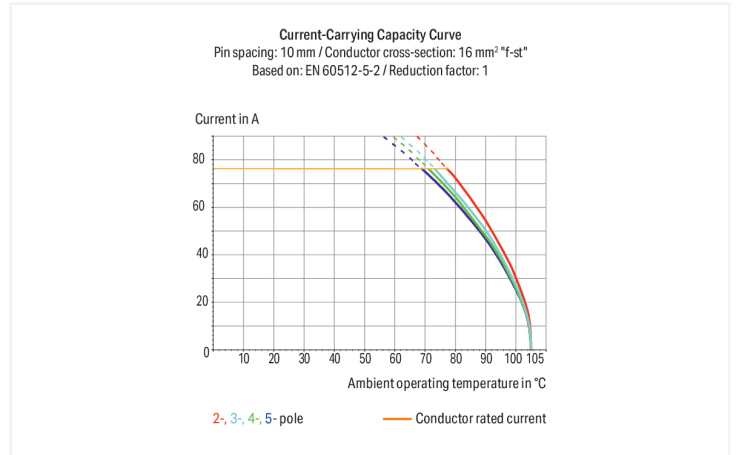

Color: ■ gray

Similar to illustration

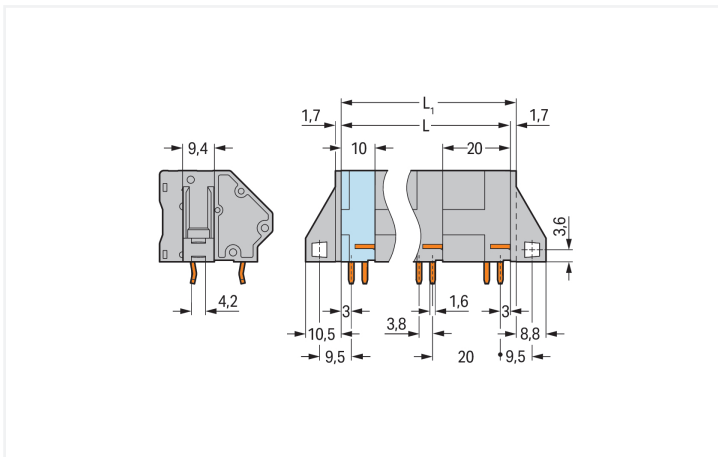

Dimensions in mm

$L = (\text{pole no.} - 1) \times \text{pin spacing} + 10 \text{ mm}$
 $L_1 = L + 1.7 \text{ mm} \triangleq \text{version without mounting flange}$

PCB terminal block, 745 Series, 45 °conductor entry to board

Connecting conductors is quick and easy with this PCB terminal block (item number 745-655/006-000). It offers the flexibility needed for different mounting types. Ensure that the strip lengths are between 12 and 13 mm when connecting conductors to this PCB terminal block. This product features one conductor terminal and utilizes CAGE CLAMP®. Our reliable and maintenance-free CAGE CLAMP® connection makes it easy to connect all types of conductors without having to prepare the conductor. For example, you don't need to crimp ferrules. The dimensions are (91.7 x 33.5 x 33.4) mm (width x height x depth). This PCB terminal block is suitable for conductor cross sections ranging from 0.2 mm² to 16 mm².

Tin is used for coating the contact surfaces. This PCB terminal block is operated with an operating tool. THT is used to solder the PCB terminal block. Insert the conductor at an angle of 45°.

Notes

Variants:

Other pole numbers
 Versions for Ex e II and Ex i
 Other colors
 Mixed-color PCB connector strips
 Versions with mounting flanges
 Direct marking
 Solder pin length: 5 mm
 Other versions (or variants) can be requested from WAGO Sales or configured at <https://configurator.wago.com/>.

Electrical data

| Ratings per | IEC/EN 60664-1 | | |
|---------------------------------|----------------|--------|--------|
| Overvoltage category | III | III | II |
| Pollution degree | 3 | 2 | 2 |
| Nominal voltage | 1000 V | 1000 V | 1000 V |
| Rated impulse withstand voltage | 12 kV | 12 kV | 12 kV |
| Rated current | 76 A | 76 A | 76 A |

| Approvals per | UL 1059 | | |
|---------------|---------|-------|---|
| Use group | B | C | D |
| Rated voltage | 600 V | 600 V | - |
| Rated current | 65 A | 65 A | - |

| Approvals per | CSA | | |
|---------------|-------|-------|---|
| Use group | B | C | D |
| Rated voltage | 600 V | 600 V | - |
| Rated current | 65 A | 65 A | - |

Connection Data

| | |
|----------------------------|---|
| Clamping units | 5 |
| Total number of potentials | 5 |
| Number of connection types | 1 |
| Number of levels | 1 |
| Number of jumper slots | 1 |

| Connection 1 | |
|---|---|
| Connection technology | CAGE CLAMP® |
| Actuation type | Operating tool |
| Solid conductor | 0.2 ... 16 mm ² / 24 ... 6 AWG |
| Fine-stranded conductor | 0.2 ... 16 mm ² / 24 ... 6 AWG |
| Fine-stranded conductor; with insulated ferrule | 0.25 ... 10 mm ² |
| Fine-stranded conductor; with uninsulated ferrule | 0.25 ... 10 mm ² |
| Strip length | 12 ... 13 mm / 0.47 ... 0.51 inches |
| Conductor connection direction to PCB | 45 ° |
| Pole number | 5 |

Physical data

| | |
|-------------------------|--------------------------|
| Pin spacing | 20 mm / 0.787 inches |
| Width | 91.7 mm / 3.61 inches |
| Height | 33.5 mm / 1.319 inches |
| Height from the surface | 27 mm / 1.063 inches |
| Depth | 33.4 mm / 1.315 inches |
| Solder pin length | 6.5 mm |
| Solder pin dimensions | 1.2 x 1.6 mm |
| ! | 2.2 ^(±0.1) mm |

PCB contact

| | |
|-------------------------------------|--|
| PCB contact | THT |
| Solder pin arrangement | over the entire terminal strip (in-line) |
| Number of solder pins per potential | 4 |

Material data

| | |
|------------------------------------|--|
| Note (material data) | Information on material specifications can be found here |
| Color | gray |
| Material group | I |
| Insulation material (main housing) | Polyamide (PA66) |
| Flammability class per UL94 | V0 |
| Clamping spring material | Chrome-nickel spring steel (CrNi) |
| Contact material | Electrolytic copper (E _{cu}) |
| Contact Plating | Tin |
| Fire load | 1.107 MJ |
| Weight | 60.5 g |

Environmental requirements

| | |
|-------------------------|-----------------|
| Limit temperature range | -60 ... +105 °C |
|-------------------------|-----------------|

Commercial data

| | |
|-----------------------|--------------------------------|
| Product Group | 4 (Printed Circuit Connectors) |
| PU (SPU) | 8 pcs |
| Packaging type | Box |
| Country of origin | PL |
| GTIN | 4044918303095 |
| Customs tariff number | 85369010000 |

Product Classification

| | |
|-------------|----------------------|
| UNSPSC | 39121409 |
| eCl@ss 10.0 | 27-44-04-01 |
| eCl@ss 9.0 | 27-44-04-01 |
| ETIM 9.0 | EC002643 |
| ETIM 10.0 | EC002643 |
| ECCN | NO US CLASSIFICATION |

Environmental Product Compliance

| | |
|------------------------|-------------------------|
| RoHS Compliance Status | Compliant, No Exemption |
|------------------------|-------------------------|

Approvals / Certificates

General approvals



General approvals

| | | |
|--------------------------------|---------|--------|
| UR | UL 1059 | E45172 |
| Underwriters Laboratories Inc. | | |

| Approval | Standard | Certificate Name |
|---------------------------------|---------------|------------------|
| CCA DEKRA Certification B.V. | EN 60947 | 2160584.14 |
| CCA DEKRA Certification B.V. | EN 60947 | NTR NL-7094 |
| CSA DEKRA Certification B.V. | C22.2 No. 158 | 1604421 |

Declarations of conformity and manufacturer's declarations

| Approval | Standard | Certificate Name |
|---|----------|------------------|
| EU-Declaration of Confor- mity WAGO GmbH & Co. KG | - | - |
| UK-Declaration of Confor- mity WAGO GmbH & Co. KG | - | - |

Downloads

Environmental Product Compliance

Compliance Search

| | |
|--|---|
| Environmental Product Compliance 745-655/006-000 | ↓ |
|--|---|

Documentation

Additional Information

| | | | |
|-------------------|------------|-------------------|---|
| Technical Section | 03.04.2019 | pdf 2027.26 KB | ↓ |
|-------------------|------------|-------------------|---|

CAD/CAE-Data

CAD data

| | |
|---------------------------------|---|
| 2D/3D Models 745-655/006-000 | ↓ |
|---------------------------------|---|

CAE data

| | |
|--------------------------------------|---|
| EPLAN Data Portal 745-655/006-000 | ↓ |
| ZUKEN Portal 745-655/006-000 | ↓ |

PCB Design

| | |
|--|---|
| Symbol and Footprint via SamacSys 745-655/006-000 | ↓ |
| Symbol and Footprint via Ultra Librarian 745-655/006-000 | ↓ |

1 Compatible Products

1.1 Optional Accessories

1.1.1 Ferrule

1.1.1.1 Ferrule



Item No.: 216-262
 Ferrule; Sleeve for 0.75 mm² / 18 AWG; insulated; electro-tin plated; electrolytic copper; gastight crimped; acc. to DIN 46228, Part 4/09.90; gray



Item No.: 216-263
 Ferrule; Sleeve for 1 mm² / AWG 18; insulated; electro-tin plated; electrolytic copper; gastight crimped; acc. to DIN 46228, Part 4/09.90; red



Item No.: 216-264
 Ferrule; Sleeve for 1.5 mm² / AWG 16; insulated; electro-tin plated; electrolytic copper; gastight crimped; acc. to DIN 46228, Part 4/09.90; black



Item No.: 216-284
 Ferrule; Sleeve for 1.5 mm² / AWG 16; insulated; electro-tin plated; electrolytic copper; gastight crimped; acc. to DIN 46228, Part 4/09.90; black



Item No.: 216-289
 Ferrule; Sleeve for 10 mm² / AWG 8; insulated; electro-tin plated; electrolytic copper; gastight crimped; acc. to DIN 46228, Part 4/09.90; red



Item No.: 216-209
 Ferrule; Sleeve for 10 mm² / AWG 8; insulated; electro-tin plated; red



Item No.: 216-109
 Ferrule; Sleeve for 10 mm² / AWG 8; un-insulated; electro-tin plated



Item No.: 216-266
 Ferrule; Sleeve for 2.5 mm² / AWG 14; insulated; electro-tin plated; electrolytic copper; gastight crimped; acc. to DIN 46228, Part 4/09.90; blue



Item No.: 216-286
 Ferrule; Sleeve for 2.5 mm² / AWG 14; insulated; electro-tin plated; electrolytic copper; gastight crimped; acc. to DIN 46228, Part 4/09.90; blue



Item No.: 216-267
 Ferrule; Sleeve for 4 mm² / AWG 12; insulated; electro-tin plated; electrolytic copper; gastight crimped; acc. to DIN 46228, Part 4/09.90; gray



Item No.: 216-287
 Ferrule; Sleeve for 4 mm² / AWG 12; insulated; electro-tin plated; electrolytic copper; gastight crimped; acc. to DIN 46228, Part 4/09.90; gray



Item No.: 216-208
 Ferrule; Sleeve for 6 mm² / AWG 10; insulated; electro-tin plated; electrolytic copper; gastight crimped; acc. to DIN 46228, Part 4/09.90; yellow



Item No.: 216-288
 Ferrule; Sleeve for 6 mm² / AWG 10; insulated; electro-tin plated; electrolytic copper; gastight crimped; acc. to DIN 46228, Part 4/09.90; yellow



Item No.: 216-108
 Ferrule; Sleeve for 6 mm² / AWG 10; un-insulated; electro-tin plated; silver-colored

1.1.2 Jumper

1.1.2.1 Jumper



Item No.: 745-681
 Jumper; 2-way; unplated; silver-colored



Item No.: 745-682
 Jumper; 2-way; unplated; silver-colored



Item No.: 745-683
 Jumper; 3-way; silver-colored



Item No.: 745-684
 Jumper; 4-way; unplated; silver-colored



Item No.: 745-685
 Jumper; 5-way; silver-colored

1.1.3 Marking

1.1.3.1 Marker



Item No.: 2009-145/000-006
 Mini-WSB Inline; for Smart Printer; 1700 pieces on roll; stretchable 5 - 5.2 mm; plain; snap-on type; blue



Item No.: 2009-145/000-007
 Mini-WSB Inline; for Smart Printer; 1700 pieces on roll; stretchable 5 - 5.2 mm; plain; snap-on type; gray



Item No.: 2009-145/000-023
 Mini-WSB Inline; for Smart Printer; 1700 pieces on roll; stretchable 5 - 5.2 mm; plain; snap-on type; green



Item No.: 2009-145/000-012
 Mini-WSB Inline; for Smart Printer; 1700 pieces on roll; stretchable 5 - 5.2 mm; plain; snap-on type; orange



Item No.: 2009-145/000-005
 Mini-WSB Inline; for Smart Printer; 1700 pieces on roll; stretchable 5 - 5.2 mm; plain; snap-on type; red



Item No.: 2009-145/000-024
 Mini-WSB Inline; for Smart Printer; 1700 pieces on roll; stretchable 5 - 5.2 mm; plain; snap-on type; violet



Item No.: 2009-145
 Mini-WSB Inline; for Smart Printer; 1700 pieces on roll; stretchable 5 - 5.2 mm; plain; snap-on type; white



Item No.: 2009-145/000-002
 Mini-WSB Inline; for Smart Printer; 1700 pieces on roll; stretchable 5 - 5.2 mm; plain; snap-on type; yellow

1.1.3.1 Marker



Item No.: 248-501/000-006

Mini-WSB marking card; as card; not stretchable; plain; snap-on type; blue



Item No.: 248-501/000-007

Mini-WSB marking card; as card; not stretchable; plain; snap-on type; gray



Item No.: 248-501/000-023

Mini-WSB marking card; as card; not stretchable; plain; snap-on type; green



Item No.: 248-501/000-017

Mini-WSB marking card; as card; not stretchable; plain; snap-on type; light green



Item No.: 248-501/000-012

Mini-WSB marking card; as card; not stretchable; plain; snap-on type; orange



Item No.: 248-501/000-005

Mini-WSB marking card; as card; not stretchable; plain; snap-on type; red



Item No.: 248-501/000-024

Mini-WSB marking card; as card; not stretchable; plain; snap-on type; violet



Item No.: 248-501

Mini-WSB marking card; as card; not stretchable; plain; snap-on type; white



Item No.: 248-501/000-002

Mini-WSB marking card; as card; not stretchable; plain; snap-on type; yellow



Item No.: 793-5501/000-006

WMB marking card; as card; for terminal block width 5 - 17.5 mm; stretchable 5 - 5.2 mm; plain; snap-on type; blue



Item No.: 793-5501/000-007

WMB marking card; as card; for terminal block width 5 - 17.5 mm; stretchable 5 - 5.2 mm; plain; snap-on type; gray



Item No.: 793-5501/000-023

WMB marking card; as card; for terminal block width 5 - 17.5 mm; stretchable 5 - 5.2 mm; plain; snap-on type; green



Item No.: 793-5501/000-017

WMB marking card; as card; for terminal block width 5 - 17.5 mm; stretchable 5 - 5.2 mm; plain; snap-on type; light green



Item No.: 793-5501/000-012

WMB marking card; as card; for terminal block width 5 - 17.5 mm; stretchable 5 - 5.2 mm; plain; snap-on type; orange



Item No.: 793-5501/000-005

WMB marking card; as card; for terminal block width 5 - 17.5 mm; stretchable 5 - 5.2 mm; plain; snap-on type; red



Item No.: 793-5501/000-024

WMB marking card; as card; for terminal block width 5 - 17.5 mm; stretchable 5 - 5.2 mm; plain; snap-on type; violet



Item No.: 793-5501

WMB marking card; as card; for terminal block width 5 - 17.5 mm; stretchable 5 - 5.2 mm; plain; snap-on type; white



Item No.: 793-5501/000-002

WMB marking card; as card; for terminal block width 5 - 17.5 mm; stretchable 5 - 5.2 mm; plain; snap-on type; yellow



Item No.: 793-501

WMB marking card; as card; not stretchable; plain; snap-on type; white



Item No.: 2009-115/000-006

WMB-Inline; for Smart Printer; 1500 pieces on roll; stretchable 5 - 5.2 mm; plain; snap-on type; blue



Item No.: 2009-115/000-007

WMB-Inline; for Smart Printer; 1500 pieces on roll; stretchable 5 - 5.2 mm; plain; snap-on type; gray



Item No.: 2009-115/000-023

WMB-Inline; for Smart Printer; 1500 pieces on roll; stretchable 5 - 5.2 mm; plain; snap-on type; green



Item No.: 2009-115/000-017

WMB-Inline; for Smart Printer; 1500 pieces on roll; stretchable 5 - 5.2 mm; plain; snap-on type; light green



Item No.: 2009-115/000-012

WMB-Inline; for Smart Printer; 1500 pieces on roll; stretchable 5 - 5.2 mm; plain; snap-on type; orange



Item No.: 2009-115/000-024

WMB-Inline; for Smart Printer; 1500 pieces on roll; stretchable 5 - 5.2 mm; plain; snap-on type; violet



Item No.: 2009-115

WMB-Inline; for Smart Printer; 1500 pieces on roll; stretchable 5 - 5.2 mm; plain; snap-on type; white



Item No.: 2009-115/000-002

WMB-Inline; for Smart Printer; 1500 pieces on roll; stretchable 5 - 5.2 mm; plain; snap-on type; yellow

1.1.4 Test and measurement

1.1.4.1 Testing accessories



Item No.: 210-136

Test plug; 2 mm Ø; with 500 mm cable; red

1.1.5 Tool

1.1.5.1 Operating tool



Item No.: 210-721

Operating tool; Blade: 5.5 x 0.8 mm; with a partially insulated shaft; multicoloured

Installation Notes

Conductor termination

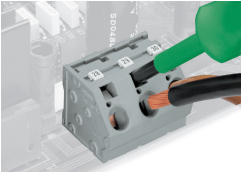

Inserting/removing a conductor via 5.5 mm screwdriver – 745 Series, 16 mm².

Marking

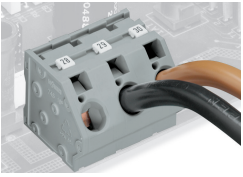

Marking via Mini-WSB and WMB markers or factory direct marking – 745 Series.

Testing

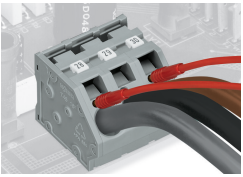

Testing with test plug – 745 Series.

Commoning

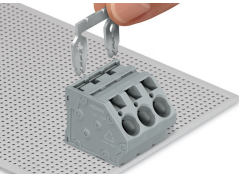

Inserting a comb-style jumper bar.

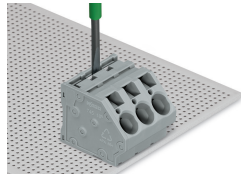

To insert a comb-style jumper bar, push it down using a screwdriver until it hits the backstop – 745 Series.

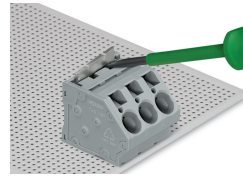

To remove the jumper bar, lift it up using a screwdriver – 745 Series.