

## Data Sheet | Item Number: 218-516

PCB terminal block; Locking slides; 0.5 mm<sup>2</sup>; Pin spacing 2.54 mm; 16-pole; CAGE CLAMP®; gray

<https://www.wago.com/218-516>



Color: ■ gray

Similar to illustration

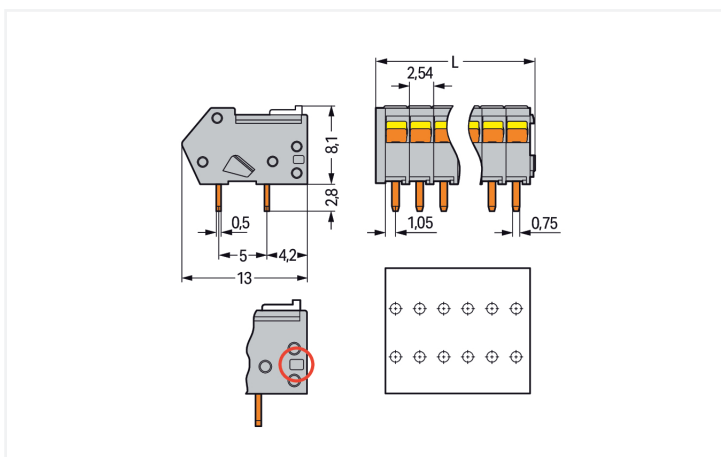
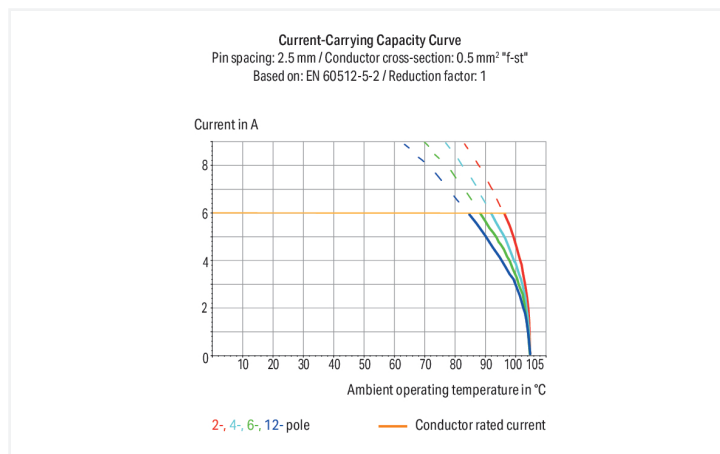

Dimensions in mm

L = (pole no. x pin spacing) + 1.5 mm groove at the back of the terminal strip indicates the 2.54 mm pin spacing (red circle).

### PCB terminal block, 218 Series, gray

This PCB terminal block (item number 218-516) is designed to connect conductors quickly and easily. You can count on tried and tested safety with these PCB terminal blocks, perfect for a wide range of applications when designing your devices. Conductors can only be connected to this PCB terminal block if their strip length is between 5 and 6 mm. This product incorporates one conductor terminal and utilizes CAGE CLAMP®. Our reliable and maintenance-free CAGE CLAMP® connection makes it easy to connect all types of conductors without having to prepare the conductor. For example, you don't need to crimp ferrules. Dimensions: (42.14 x 10.9 x 13) mm (width x height x depth). Depending on the type of conductor, this PCB terminal block is ideal for conductor cross sections ranging from 0.08 mm<sup>2</sup> to 0.5 mm<sup>2</sup>. Tin is used for coating the contact surfaces. A slider is used to operate this PCB terminal block. THT is used to solder the PCB terminal block. The conductor is designed to be inserted at an angle of 40°..

## Notes

Variants:	Other pole numbers Other colors Mixed-color PCB connector strips Direct marking Other versions (or variants) can be requested from WAGO Sales or configured at <a href="https://configurator.wago.com/">https://configurator.wago.com/</a> .
-----------	--

## Electrical data

Ratings per	IEC/EN 60664-1			Approvals per	UL 1059		
Overvoltage category	III	III	II	Use group	B	C	D
Pollution degree	3	2	2	Rated voltage	150 V	-	-
Nominal voltage	80 V	160 V	320 V	Rated current	4 A	-	-
Rated impulse withstand voltage	2.5 kV	2.5 kV	2.5 kV				
Rated current	6 A	6 A	6 A				

Approvals per	CSA		
Use group	B	C	D
Rated voltage	150 V	-	-
Rated current	4 A	-	-

## Connection Data

Clamping units	16
Total number of potentials	16
Number of connection types	1
Number of levels	1

## Connection 1

Connection technology	CAGE CLAMP®
Actuation type	Slider
Solid conductor	0.08 ... 0.5 mm <sup>2</sup> / 28 ... 20 AWG
Fine-stranded conductor	0.08 ... 0.5 mm <sup>2</sup> / 28 ... 20 AWG
Fine-stranded conductor; with insulated ferrule	0.25 mm <sup>2</sup>
Fine-stranded conductor; with uninsulated ferrule	0.25 mm <sup>2</sup>
Note (conductor cross-section)	Terminating 0.75 mm <sup>2</sup> /18 AWG conductors is possible; however insulation diameter allows only every other clamping unit to be terminated with this conductor size.
Strip length	5 ... 6 mm / 0.2 ... 0.24 inches
Conductor connection direction to PCB	40 °
Pole number	16

## Physical data

Pin spacing	2.54 mm / 0.1 inches
Width	42.14 mm / 1.659 inches
Height	10.9 mm / 0.429 inches
Height from the surface	8.1 mm / 0.319 inches
Depth	13 mm / 0.512 inches
Solder pin length	2.8 mm
Solder pin dimensions	0.5 x 0.75 mm
!	1.1 <sup>(±0.1)</sup> mm

### PCB contact

PCB contact	THT
Solder pin arrangement	over the entire terminal strip (in-line)
Number of solder pins per potential	2

### Material data

Note (material data)	<a href="#">Information on material specifications can be found here</a>
Color	gray
Material group	I
Insulation material (main housing)	Polyamide (PA66)
Flammability class per UL94	V0
Clamping spring material	Chrome-nickel spring steel (CrNi)
Contact material	Electrolytic copper (E <sub>cu</sub> )
Contact Plating	Tin
Fire load	0.275 MJ
Weight	5.2 g

### Environmental requirements

Limit temperature range	-60 ... +105 °C
-------------------------	-----------------

### Commercial data

Product Group	4 (Printed Circuit Connectors)
PU (SPU)	100 (25) pcs
Packaging type	Box
Country of origin	PL
GTIN	4044918878678
Customs tariff number	85369010000

### Product Classification

UNSPSC	39121409
eCl@ss 10.0	27-44-04-01
eCl@ss 9.0	27-44-04-01
ETIM 9.0	EC002643
ETIM 10.0	EC002643
ECCN	NO US CLASSIFICATION

### Environmental Product Compliance

RoHS Compliance Status	Compliant, No Exemption
------------------------	-------------------------

### Approvals / Certificates

#### General approvals



Approval	Standard	Certificate Name
CCA DEKRA Certification B.V.	EN 60947	NTR NL-7076
CCA DEKRA Certification B.V.	EN 60947-7-4	NTR NL-7785
CCA DEKRA Certification B.V.	EN 60947-7-4	77-111038

#### General approvals

CSA DEKRA Certification B.V.	C22.2 No. 158	1565656
ENEC DEKRA Certification B.V.	EN 60947	2160584.01
UL UL International Germany GmbH	UL 1059	E45172

**Declarations of conformity and manufacturer's declarations**

Approval	Standard	Certificate Name
EU-Declaration of Confor- mity WAGO GmbH & Co. KG	-	-
UK-Declaration of Confor- mity WAGO GmbH & Co. KG	-	-

**Downloads**

**Environmental Product Compliance**



Compliance Search
Environmental Product Compliance 218-516 

**Documentation**



Additional Information
Technical Section 03.04.2019 pdf 2027.26 KB 

**CAD/CAE-Data**

CAD data
2D/3D Models 218-516 

CAE data
EPLAN Data Portal 218-516 
ZUKEN Portal 218-516 

**PCB Design**

Symbol and Footprint via SamacSys 218-516 
Symbol and Footprint via Ultra Librarian 218-516 

## 1 Compatible Products

### 1.1 Optional Accessories

#### 1.1.1 Ferrule

##### 1.1.1.1 Ferrule



**Item No.: 216-301**

Ferrule; Sleeve for 0.25 mm<sup>2</sup> / AWG 24; insulated; electro-tin plated; yellow

**Item No.: 216-321**

Ferrule; Sleeve for 0.25 mm<sup>2</sup> / AWG 24; insulated; electro-tin plated; yellow

**Item No.: 216-151**

Ferrule; Sleeve for 0.25 mm<sup>2</sup> / AWG 24; uninsulated; electro-tin plated

**Item No.: 216-131**

Ferrule; Sleeve for 0.25 mm<sup>2</sup> / AWG 24; uninsulated; electro-tin plated; silver-colored

#### 1.1.2 Marking

##### 1.1.2.1 Marking strip



**Item No.: 210-331/254-202**

Marking strips; as a DIN A4 sheet; MARKED; 1-16 (400x); Height of marker strip: 2.3 mm/0.091 in; Strip length 182 mm; Horizontal marking; Self-adhesive; white

**Item No.: 210-331/254-207**

Marking strips; as a DIN A4 sheet; MARKED; 1-48 (100x); Height of marker strip: 2.3 mm/0.091 in; Strip length 182 mm; Horizontal marking; Self-adhesive; white

**Item No.: 210-331/254-204**

Marking strips; as a DIN A4 sheet; MARKED; 17-32 (400x); Height of marker strip: 2.3 mm/0.091 in; Strip length 182 mm; Horizontal marking; Self-adhesive; white

**Item No.: 210-331/254-206**

Marking strips; as a DIN A4 sheet; MARKED; 33-48 (400x); Height of marker strip: 2.3 mm/0.091 in; Strip length 182 mm; Horizontal marking; Self-adhesive; white

#### 1.1.3 Test and measurement

##### 1.1.3.1 Testing accessories



**Item No.: 735-500**

WAGO Test pin; 1 mm Ø; 30 V AC / 60 V DC; CAT0; 1 A; 6 mm uninsulated; Test lead for soldering up to 0,5mm<sup>2</sup>

#### 1.1.4 Tool

##### 1.1.4.1 Operating tool



**Item No.: 210-719**

Operating tool; Blade: 2.5 x 0.4 mm; with a partially insulated shaft

**Item No.: 210-648**

Operating tool; Blade: 2.5 x 0.4 mm; with a partially insulated shaft; angled; short

## Installation Notes

### Conductor termination



Terminating stranded conductors in confined spaces requires a great deal of patience, unless you use the new 218 Series PCB Terminal Strips. The clamping units of these strips can be held open during termination process via integrated locking slide.

Terminating 0.75 mm<sup>2</sup>/18 AWG conductors is possible; however insulation diameter allows only every other clamping unit to be terminated with this conductor size.

Conductor termination: To momentarily open the clamping unit, use screwdriver and then insert a stripped conductor. To open clamping unit for an extended period, move locking slide toward conductor entry hole. Then fully insert stripped conductor and move locking slide back to original position (also possible to perform with fingernail).

Incorrect – do not operate the locking slides from the back.

### Marking



Labeling with self-adhesive marking strips.

Labeling via factory direct marking.

### Testing



Testing directly on the clamping spring.