

# Productinformatieblad

Specificaties



Harmony XALD, XALK,  
Drukknopkast, Kunststof,  
Vuistslagknop Ø40,  
Draaiontgrendeling, 1 NC met  
monitoring, UL CSA

XALK1786H7

EAN Code: 3606482034990

**Prijs: 55,00 EUR**

## Hoofd

range of product	Harmony XALK
product or component type	Compleet besturingsstation
device short name	XALK
bestemming product	Voor XB5-besturings- en signaleringseenheden Ø 22 mm
toepassing hangende drukkнопkast	Nooduitschakelfunctie Noodstopfunctie
kleur behuizingsbasis	Lichtgrijs (RAL 7035)
kleur deksel	Geel (RAL 1021)
materiaal	Polycarbonaat
operator profiel	1 vuistslagknop
operatorbeschrijving	Rood zonder markering 1 NC
reset	Draaien om te ontgrendelen
samenstelling controlestation	1 vuistslagknop Ø 40 mm drukkноп, rood 1 NC niet gemarkeerd markering
werking contacten	Slow-break
product presentatie	Compleet product

## Complementair

ingang kabel	1 uitstoter voor kabelingang 0...14 mm 2 uitstoters voor plug-in 13.5 kabelpakkingbus en geïsoleerd M20
net weight	0,147 kg
contact gebruik	Contactbewaking
positieve opening	Met conform aan IEC 60947-5-1 appendix K
bedrijfstraject	1,5 mm (normaal gesloten elektrische status wijzigen) 4,3 mm (totale reis)
bedieningskracht	47 N
mechanical durability	300000 cycles
aansluitingen - aansluitklemmen	Schroefklem aansluitingen, <= 2 x 1,5 mm <sup>2</sup> met kabeluiteinde conform aan IEC 60947-1 Schroefklem aansluitingen, >= 1 x 0,34 mm <sup>2</sup> zonder kabeluiteinde conform aan IEC 60947-1
aandraaimoment	0,8...1,2 N.m conform aan IEC 60947-1

De weergegeven prijs is de adviesprijs in euro excl. BTW. Deze kan onderhevig zijn aan korting. Neem contact op met uw lokale distributeur of detailhandel voor de daadwerkelijke prijs

<b>vorm schroefkop</b>	Kruis compatibel met pozidriv Nr. 1 schroevendraaier Gegroefd compatibel met vlak Ø 4 mm schroevendraaier Gegroefd compatibel met vlak Ø 5,5 mm schroevendraaier
<b>contact materiaal</b>	Zilverlegering (Ag/Ni)
<b>kortsluitbeveiliging</b>	6 A smeltpatroon type gG conform aan IEC 60947-5-1
<b>Ith conventionele thermische stroom in vrije lucht</b>	6 A conform aan IEC 60947-5-1
<b>Ui nom isolatiespanning</b>	300 V (vervuilingsgraad 3) conform aan IEC 60947-1
<b>Uimp nom. schokgolfspanning</b>	4 kV conform aan IEC 60947-1
<b>le nom. bedrijfstrom</b>	1,5 A bij 240 V, AC-15, B300 conform aan IEC 60947-5-1 3 A bij 120 V, AC-15, B300 conform aan IEC 60947-5-1 0,11 A bij 250 V, DC-13, R300 conform aan IEC 60947-5-1 0,22 A bij 125 V, DC-13, R300 conform aan IEC 60947-5-1
<b>elektrische levensduur</b>	300000 cycles, AC-15, 2 A bij 230 V, gebruiksnelheid <3600 cyc/h, belastingsfactor: 0,5 conform aan IEC 60947-5-1 appendix C 300000 cycles, AC-15, 3 A bij 110 V, gebruiksnelheid <3600 cyc/h, belastingsfactor: 0,5 conform aan IEC 60947-5-1 appendix C 300000 cycles, AC-15, 3 A bij 24 V, gebruiksnelheid <3600 cyc/h, belastingsfactor: 0,5 conform aan IEC 60947-5-1 appendix C 300000 cycles, DC-13, 0,3 A bij 120 V, gebruiksnelheid <3600 cyc/h, belastingsfactor: 0,5 conform aan IEC 60947-5-1 appendix C 300000 cycles, DC-13, 1 A bij 24 V, gebruiksnelheid <3600 cyc/h, belastingsfactor: 0,5 conform aan IEC 60947-5-1 appendix C
<b>elektrische betrouwbaarheid</b>	$\Lambda < 10^{\exp(-6)}$ bij 5 V, 1 mA conform aan IEC 60947-5-4 $\Lambda < 10^{\exp(-8)}$ bij 17 V, 3,4 mA conform aan IEC 60947-5-4

## Omgeving

<b>beschermende behandeling</b>	TH
<b>ambient air temperature for storage</b>	-40...70 °C
<b>ambient air temperature for operation</b>	-40...70 °C
<b>overvoltage category</b>	Klasse II conforming to IEC 60536
<b>IP beschermingsgraad</b>	IP66 conform aan IEC 60529 IP67 conform aan IEC 60529 IP69 conform aan IEC 60529 IP69K conform aan ISO 20653
<b>IK-beschermingsgraad</b>	IK03 conforming to IEC 60068-2-75
<b>standards</b>	IEC 60947-1 IEC 60947-5-1 IEC 60947-5-5 IEC 60204-1 IEC 60947-5-4 IEC 60364-5-53 ISO 13850 UL 60947-5-1 CSA C22.2 Nr 60947-5-1 JIS C8201-1 JIS C8201-5-1 GB/T 14048,5 BS EN 60947-5-1 GOST IEC 60947-5-1
<b>product certifications</b>	CSA BV UL listed LROS (Lloyds register of shipping) DNV CE CCC CB-regeling UKCA EAC
<b>trilling bestendigheid</b>	5 gn (f= 10...500 Hz) conforming to IEC 60068-2-6 25 mm piek-piek (f= 2...10 Hz) conforming to IEC 60068-2-6

---

<b>schokbestendigheid</b>	30 gn (duur = 18 ms) voor halve sinusgolf versnelling conform aan IEC 60068-2-27 50 gn (duur = 11 ms) voor halve sinusgolf versnelling conform aan IEC 60068-2-27 25 gn (duur = 6 ms) voor 1000 schokken op elke as conform aan IEC 60068-2-27
---------------------------	--

## Verpakkingseenheid

---

<b>Unit Type of Package 1</b>	PCE
<b>Number of Units in Package 1</b>	1
<b>Package 1 Height</b>	7,000 cm
<b>Package 1 Width</b>	7,200 cm
<b>Package 1 Length</b>	10,000 cm
<b>Package 1 Weight</b>	166,000 g
<b>Unit Type of Package 2</b>	S03
<b>Number of Units in Package 2</b>	40
<b>Package 2 Height</b>	30,000 cm
<b>Package 2 Width</b>	30,000 cm
<b>Package 2 Length</b>	40,000 cm
<b>Package 2 Weight</b>	7,068 kg

## contractuele waarborg

---

<b>Garantie</b>	18 months
-----------------	-----------

## Environmental Data

Schneider Electric wil tegen 2050 de Net Zero-status hebben bereikt via partnerschappen in de toeleveringsketen, materialen met een lagere impact en circulariteit via onze doorlopende campagne "Use Better, Use Longer, Use Again" om de levensduur van producten en de recycleerbaarheid te verlengen.

[Uitleg van Environmental Data](#) >

[Hoe evalueren we de duurzaamheid van producten?](#) >

### Milieuoetafdruk

Totale levenscyclus ecologische voetafdruk	1
--	---

## Use Better

### Materialen en verpakking

Pakket met gerecycleerd karton	Ja
--------------------------------	----

Verpakkingen zonder kunststof	Ja
-------------------------------	----

<a href="#">EU-richtlijn RoHS</a>	Voldoet
-----------------------------------	---------

## Use Again

### Herverpakken en herfabriceren

Terugname	No
-----------	----

WEEE Label	 Het product moet op markten van de Europese Unie worden afgevoerd volgens specifieke afvalinzamelingsregels en mag nooit in een gewone vuilnisbak terechtkomen.
------------	---

Dimensions Drawings

Dimensions

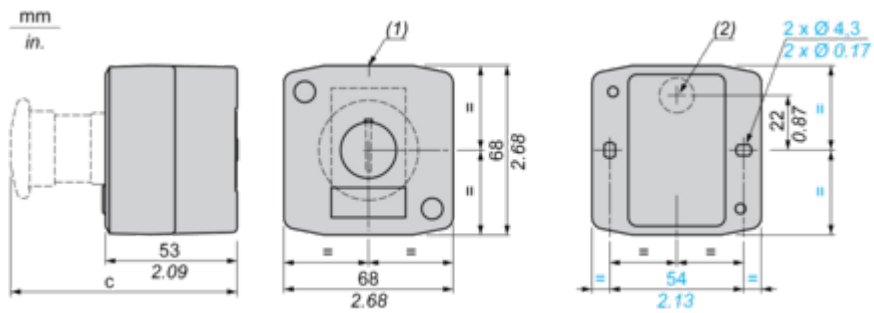

(1) 2 knock-outs for Pg 13.5 cable gland, maximum capacity 12 mm/0.47 in.





(2) Knock-out for cable entry, maximum capacity 14 mm/0.55 in.

Control station fitted with:	c in mm	c in in.
Flush pushbutton	62	2.44
Pilot light	64	2.52
Illuminated pushbutton	65.5	2.58
Projecting pushbutton	66	2.60
Selector switch	80	3.15
Mushroom head pushbutton	91.5	3.58
Latching mushroom head Emergency stop pushbutton with key	115	4.53
Key switch	105.5	4.15

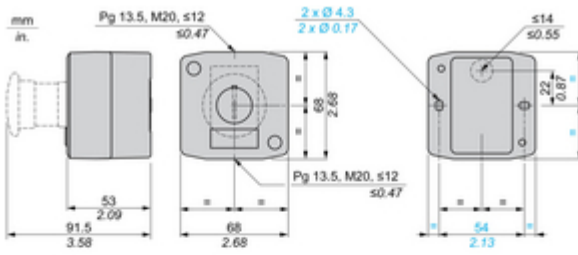
Technical Illustration

Dimensions



C	mm	in.
 ZB5AA●, ZB5AH0●	62	2.44
 ZB5AV●	64	2.52
 ZB5AW3●	65.5	2.58
 ZB5AL●, ZB5AW1●, ZB5AH●, ZB5AH●3	66	2.6
 ZB5AD●, ZB5AK●	80	3.15
 ZB5AS3●, ZB5AT●, ZB5AC●, ZB5AR●, ZB5AW4●, ZB5AW6●, ZB5AS4●, ZB5AS5●, ZB5AS6●	91.5	3.58
 ZB5AS9●, ZB5AS1●, ZB5AS7●	115	4.53
 ZB5AG●	105.5	4.15

Offer Marketing Illustration

Product benefits / Features

---

## Features Harmony XALK



Complete stations for emergency stop function with a single mushroom head non-illuminated or illuminated function from XB5 range



Possibility to add up to 3 NO or NC contact blocks per operating head



Complete, ready-to-install stations with 1 to 3 buttons for the most common functions



Polycarbonate pre-drilled control stations



Modular system and simple to cable universal range



Offer Marketing Illustration

Product benefits / Features

---

## Features Harmony XALK

  
Complete stations for emergency stop function with a single mushroom head non-illuminated or illuminated function from XB5 range

  
Possibility to add up to 3 NO or NC contact blocks per operating head

  
Complete, ready-to-install stations with 1 to 3 buttons for the most common functions

  
Polycarbonate pre-drilled control stations



  
Modular system and simple to cable universal range

Offer Marketing Illustration

Product benefits / Features

---

### Technical Benefits

#### Harmony XALK

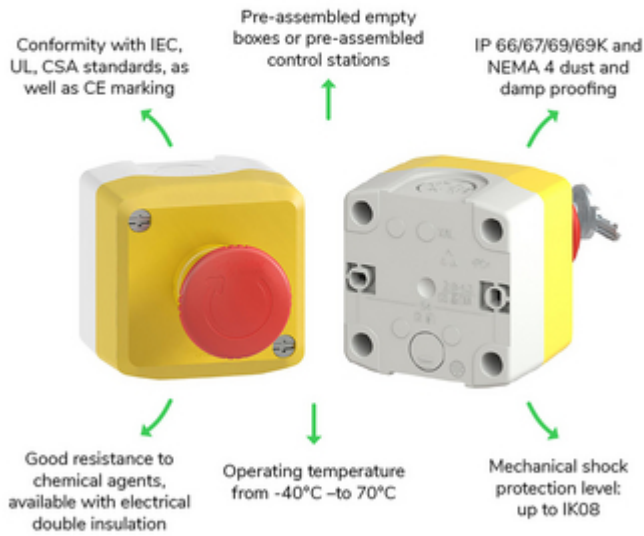

Offer Marketing Illustration

Product benefits / Features

---

### Technical Benefits

#### Harmony XALK

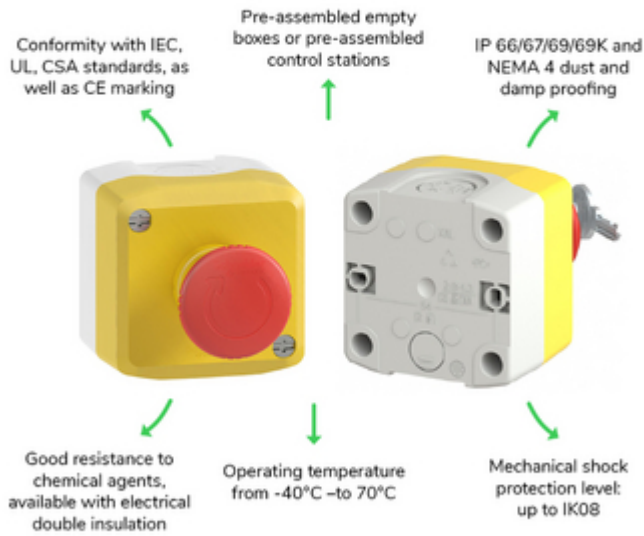

Image of product / Alternate images

Alternative

---



