

Data Sheet | Item Number: 750-467
 2-channel analog input; 0 ... 10 VDC; Single-ended

<https://www.wago.com/750-467>

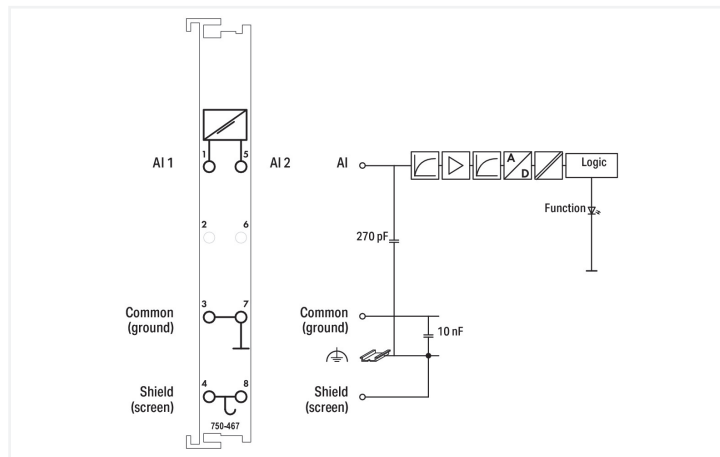

Color: ■ light gray

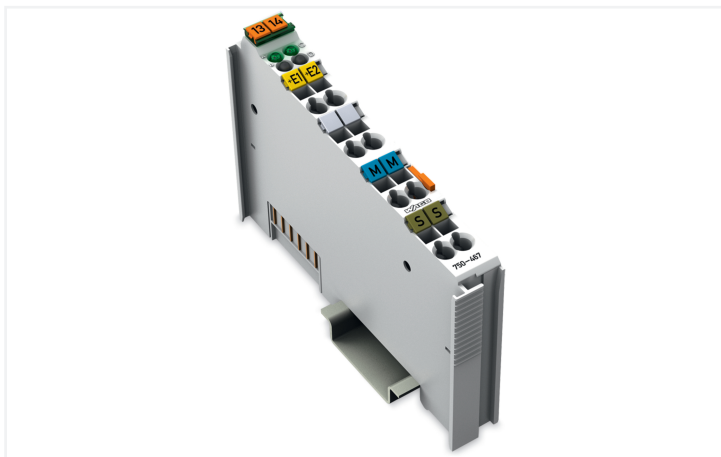
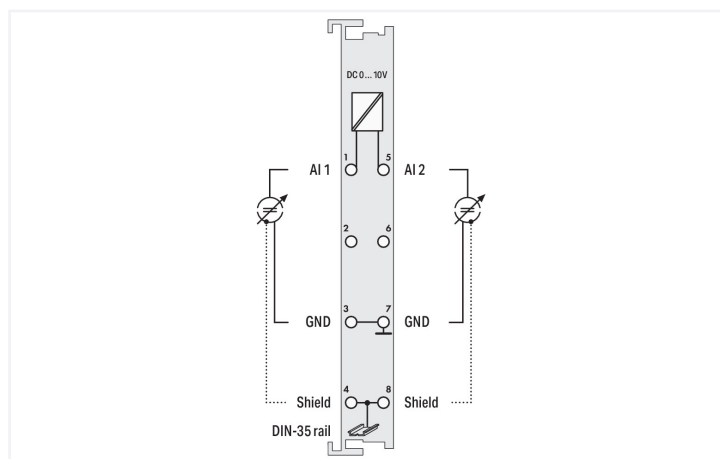
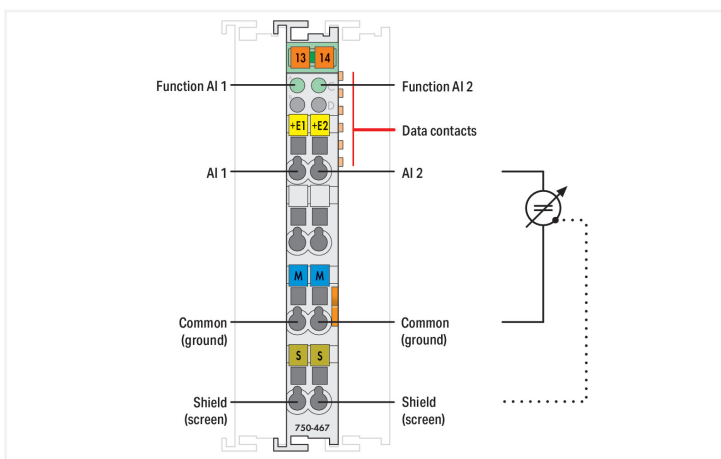

This analog input module processes standard 0–10 V signals.
 The input signal is electrically isolated and is transmitted with a resolution of 12 bits.
 The internal system supply powers the module.
 The input channels of the module have a common ground potential.
 The shield directly connects to the DIN-rail.

Technical data

Number of analog inputs	2
Total number of channels (module)	2
Signal type	Voltage
Signal type (voltage)	0 ... 10 VDC
Sensor connection	2 x (2-wire)
Input voltage (max.)	35 V
Signal characteristics	Single-ended
Resolution [bit]	12 bits
Data width	2 x 16-bit data; 2 x 8-bit control/status (optional)
Internal resistance	130 kΩ
Conversion time (typ.)	2 ms
Measurement error (reference temperature)	25 °C
Measurement error, deviation (max.) from the upper-range value	0.2 %

Technical data

Temperature error (max.) of the upper-range value	0.01 %/K
Supply voltage (system)	5 VDC; via data contacts
Current consumption (5 V system supply)	60 mA
Isolation	500 V system/field
Indicators	LED (A, C) green: Function AI 1, AI 2

Connection Data

Connection technology: I/O	6 x CAGE CLAMP®
Connectable conductor materials	Copper
Connection type	Inputs/outputs
Solid conductor	0.08 ... 2.5 mm ² / 28 ... 14 AWG
Fine-stranded conductor	0.08 ... 2.5 mm ² / 28 ... 14 AWG
Strip length	8 ... 9 mm / 0.31 ... 0.35 inches

Physical data

Width	12 mm / 0.472 inches
Height	100 mm / 3.937 inches
Depth	69.8 mm / 2.748 inches
Depth from upper-edge of DIN-rail	62.6 mm / 2.465 inches

Mechanical data

Mounting type	DIN-35 rail
Pluggable connector	fixed

Material data

Color	light gray
Housing material	Polycarbonate; polyamide 6.6
Fire load	0.709 MJ
Weight	47.6 g
Conformity marking	CE

Environmental requirements

Ambient temperature (operation)	0 ... +55 °C
Ambient temperature (storage)	-40 ... +85 °C
Protection type	IP20
Pollution degree	2 per IEC 61131-2
Operating altitude	0 ... 2000 m / 0 ... 6562 ft
Mounting position	Horizontal left, horizontal right, horizontal top, horizontal bottom, vertical top and vertical bottom
Relative humidity (without condensation)	95 %
Vibration resistance	Per IEC 60068-2-6
Shock resistance	15g per IEC 60068-2-27
EMC immunity to interference	per EN 61000-6-2
EMC emission of interference	per EN 61000-6-4
Exposure to pollutants	per IEC 60068-2-42 and IEC 60068-2-43
Permissible H ₂ S contaminant concentration at a relative humidity 75 %	10 ppm
Permissible SO ₂ contaminant concentration at a relative humidity 75 %	25 ppm

Commercial data

Product Group	15 (I/O System)
PU (SPU)	1 pcs
Packaging type	Box
Country of origin	DE
GTIN	4045454392994
Customs tariff number	85389099990

Product Classification

UNSPSC	32101602
eCl@ss 10.0	27-24-26-01
eCl@ss 9.0	27-24-26-01
ETIM 9.0	EC001596
ETIM 10.0	EC001596
ECCN	NO US CLASSIFICATION

Environmental Product Compliance

CAS-No.	1303-86-2 1317-36-8 7439-92-1
REACH Candidate List Substance	Diboron trioxide Lead Lead monoxide
RoHS Compliance Status	Compliant,With Exemption
RoHS Exemption	7(c)-I
SCIP notification number (Austria)	7daf7c58-b236-4e47-9b75-6d15ff655b93
SCIP notification number (Belgium)	f0b934af-d8c6-4c3a-b00d-c31ec437ff6a
SCIP notification number (Bulgaria)	8b9c2188-4d74-44c1-865c-612307cd25e2
SCIP notification number (Czech Republic)	9f780f42-565a-41dd-be95-afb8da4d44fd
SCIP notification number (Denmark)	1756c932-55b9-4e30-9b73-1d19fdb7c2bd
SCIP notification number (Finland)	82f550b8-d48d-4477-897b-8c9fd2cf2fcc
SCIP notification number (France)	dea70fdb-33b9-416d-8c1e-88e737e8690e
SCIP notification number (Germany)	787c35fc-c496-4354-9d28-b9aea662a11a
SCIP notification number (Hungary)	4c8befe0-9e01-46b6-8a6e-cf80f25f731a
SCIP notification number (Italy)	e3698ec4-a690-4767-a299-aa046343070e
SCIP notification number (Netherlands)	c31ba6ec-fcae-49de-bc97-5394159d4295
SCIP notification number (Poland)	11831b17-7a0d-43d0-8ef1-b9cc6e0bb45a
SCIP notification number (Romania)	8ce057ae-9f70-46f5-8327-f805024916cc
SCIP notification number (Sweden)	1ae5e9cf-a405-425c-8687-40f8ffa78648

Approvals / Certificates

General approvals



Approval	Standard	Certificate Name
EAC GZO Almaty Standart	TP TC 020/2011	EAC CoC 03083
KC National Radio Research Agency	Article 58-2, Clause 3	MSIP-REM-W43-AIM750
UL Underwriters Laboratories Inc. (ORDINARY LOCATIONS)	UL 508	E175199

Declarations of conformity and manufacturer's declarations

Approval	Standard	Certificate Name
EU-Declaration of Conformity WAGO GmbH & Co. KG	-	-
UK-Declaration of Conformity WAGO GmbH & Co. KG	-	-

Approvals for hazardous areas



Approval	Standard	Certificate Name
ATEX TUEV Nord Cert GmbH	EN 60079-0	TUEV14ATEX148929X (II 3 G Ex ec IIC T4 Gc)
CCCEX CQST/CNEX	CNCA-C23-01	2020312310000213 (Ex ec IIC T4 Gc)
IECEX TUEV Nord Cert GmbH	IEC 60079-0	IECEX TUN 14.0035 X (Ex ec IIC T4 Gc)
INMETRO TÜV Rheinland do Brasil Ltda.	IEC 60079-0	TÜV 12.1297 X
UKEx WAGO GmbH & Co. KG	EN 60079-0	UKCA_WA GO22UKEX003X_ec
UL Underwriters Laboratories Inc. (HAZARDOUS LOCATIONS)	UL 121201	E198726

Downloads

Environmental Product Compliance

Compliance Search

Environmental Product Compliance 750-467



Documentation

Manual			
Product Manual 2-channel, 0-10VDC, single-ended	V 1.0.4	pdf 1979.89 KB	
System Manual Series 750/753			

System Description			
750/753 Series I/O-System – General Product Information		pdf 953.35 KB	
Overview on WAGO-I/O-SYSTEM 750 approvals		pdf 770.48 KB	

Bid Text			
750-467	16.09.2019	xml 5.64 KB	
750-467	28.06.2017	doc 27.50 KB	
750-467	28.06.2017	docx 16.84 KB	
ausschreiben.de 750-467			

Instruction Leaflet			
CCC Ex (Additional information)	26.04.2023	pdf 159.76 KB	

CAD/CAE-Data

CAD data	CAE data
2D/3D Models 750-467	EPLAN Data Portal 750-467
	WSCAD Universe 750-467
	ZUKEN Portal 750-467

Device Files

Device Driver			
WAGO USB Service Kabel Treiber / Serie 750 und 857	6.5.3.0 10.09.2014	zip 4721.96 KB	

1 Compatible Products

1.1 Optional Accessories

1.1.1 DIN-rail

1.1.1.1 Mounting accessories



Item No.: 210-196

Aluminum carrier rail; 35 x 8.2 mm; 1.6 mm thick; 2 m long; unslotted; similar to EN 60715; silver-colored



Item No.: 210-198

Copper carrier rail; 35 x 15 mm; 2.3 mm thick; 2 m long; unslotted; according to EN 60715; copper-colored



Item No.: 210-197

Steel carrier rail; 35 x 15 mm; 1.5 mm thick; 2 m long; slotted; similar to EN 60715; silver-colored



Item No.: 210-114

Steel carrier rail; 35 x 15 mm; 1.5 mm thick; 2 m long; unslotted; similar to EN 60715; silver-colored



Item No.: 210-118

Steel carrier rail; 35 x 15 mm; 2.3 mm thick; 2 m long; unslotted; according to EN 60715; silver-colored



Item No.: 210-112

Steel carrier rail; 35 x 7.5 mm; 1 mm thick; 2 m long; slotted; according to EN 60715; "Hole width 25 mm; silver-colored



Item No.: 210-113

Steel carrier rail; 35 x 7.5 mm; 1 mm thick; 2 m long; unslotted; according to EN 60715; silver-colored

1.1.2 Marking

1.1.2.1 Group marker carrier



Item No.: 750-106

Group marker carrier

1.1.2.2 Marker



Item No.: 750-100

Marker card; as a DIN A4 sheet; plain

Item No.: 2009-145/000-006

Mini-WSB Inline; for Smart Printer; 1700 pieces on roll; stretchable 5 - 5.2 mm; plain; snap-on type; blue

Item No.: 2009-145/000-007

Mini-WSB Inline; for Smart Printer; 1700 pieces on roll; stretchable 5 - 5.2 mm; plain; snap-on type; gray

Item No.: 2009-145/000-023

Mini-WSB Inline; for Smart Printer; 1700 pieces on roll; stretchable 5 - 5.2 mm; plain; snap-on type; green



Item No.: 2009-145/000-012

Mini-WSB Inline; for Smart Printer; 1700 pieces on roll; stretchable 5 - 5.2 mm; plain; snap-on type; orange

Item No.: 2009-145/000-005

Mini-WSB Inline; for Smart Printer; 1700 pieces on roll; stretchable 5 - 5.2 mm; plain; snap-on type; red











Item No.: 2009-145/000-024

Mini-WSB Inline; for Smart Printer; 1700 pieces on roll; stretchable 5 - 5.2 mm; plain; snap-on type; violet

Item No.: 2009-145

Mini-WSB Inline; for Smart Printer; 1700 pieces on roll; stretchable 5 - 5.2 mm; plain; snap-on type; white

1.1.2.2 Marker





 <p>Item No.: 2009-145/000-002 Mini-WSB Inline; for Smart Printer; 1700 pieces on roll; stretchable 5 - 5.2 mm; plain; snap-on type; yellow</p>	 <p>Item No.: 248-501/000-006 Mini-WSB marking card; as card; not stretchable; plain; snap-on type; blue</p>	 <p>Item No.: 248-501/000-007 Mini-WSB marking card; as card; not stretchable; plain; snap-on type; gray</p>	 <p>Item No.: 248-501/000-023 Mini-WSB marking card; as card; not stretchable; plain; snap-on type; green</p>
 <p>Item No.: 248-501/000-017 Mini-WSB marking card; as card; not stretchable; plain; snap-on type; light green</p>	 <p>Item No.: 248-501/000-012 Mini-WSB marking card; as card; not stretchable; plain; snap-on type; orange</p>	 <p>Item No.: 248-501/000-005 Mini-WSB marking card; as card; not stretchable; plain; snap-on type; red</p>	 <p>Item No.: 248-501/000-024 Mini-WSB marking card; as card; not stretchable; plain; snap-on type; violet</p>
 <p>Item No.: 248-501 Mini-WSB marking card; as card; not stretchable; plain; snap-on type; white</p>	 <p>Item No.: 248-501/000-002 Mini-WSB marking card; as card; not stretchable; plain; snap-on type; yellow</p>		

1.1.2.3 Marker carrier

 <p>Item No.: 750-103 Group marker carrier</p>
--

1.1.3 Shield termination

1.1.3.1 Shield clamping saddles

 <p>Item No.: 790-108 Shield clamping saddle; 11 mm wide; diameter of compatible conductor; 3 ... 8 mm</p>	 <p>Item No.: 790-208 Shield clamping saddle; 12.4 mm wide; 3 ... 8 mm</p>	 <p>Item No.: 790-116 Shield clamping saddle; 19 mm wide; diameter of compatible conductor; 7 ... 16 mm</p>	 <p>Item No.: 790-216 Shield clamping saddle; 21.8 mm wide; 6 ... 16 mm</p>
 <p>Item No.: 790-124 Shield clamping saddle; 27 mm wide; diameter of compatible conductor; 6 ... 24 mm</p>	 <p>Item No.: 790-220 Shield clamping saddle; 30 mm wide; 6 ... 20 mm</p>	 <p>Item No.: 790-140 Shield clamping saddle; diameter of compatible conductor</p>	

1.1.4 System enclosure

1.1.4.1 System enclosure

 <p>Item No.: 850-825 IP65 enclosure; Aluminium (RAL 7032); WxHxD (160x100x160 mm); 9 x M12, 4 x M20</p>	 <p>Item No.: 850-826 IP65 enclosure; Aluminium (RAL 7032); WxHxD (240x100x160 mm); 4 x M20, 4 x M16, 14 x M12 cable grip</p>	 <p>Item No.: 850-827 IP65 enclosure; Aluminium (RAL 7032); WxHxD (320x100x160 mm); 4 x M20, 8 x M16, 17 x M12 cable grip</p>	 <p>Item No.: 850-828 IP65 enclosure; Aluminium (RAL 7032); WxHxD (480x100x160 mm); 4 x M20, 10 x M16, 35 x M12 cable grip</p>
 <p>Item No.: 850-826/002-000 IP65 enclosure; Aluminium (RAL 7035); WxHxD (240x100x160 mm); 4 x M20, 4 x M16, 14 x M12 cable grip</p>	 <p>Item No.: 850-827/002-000 IP65 enclosure; Aluminium (RAL 7035); WxHxD (320x100x160 mm); 4 x M20, 8 x M16, 17 x M12 cable grip</p>	 <p>Item No.: 850-828/002-000 IP65 enclosure; Aluminium (RAL 7035); WxHxD (480x100x160 mm); 4 x M20, 10 x M16, 35 x M12 cable grip</p>	 <p>Item No.: 850-834 IP65 enclosure; Polyester (RAL 7032); WxHxD (164x100x164 mm); 9 x M12, 4 x M20</p>
 <p>Item No.: 850-835 IP65 enclosure; Polyester (RAL 7032); WxHxD (244x100x164 mm); 4 x M20, 4 x M16, 14 x M12 cable grip</p>	 <p>Item No.: 850-836 IP65 enclosure; Polyester (RAL 7032); WxHxD (324x100x164 mm); 4 x M20, 8 x M16, 17 x M12 cable grip</p>	 <p>Item No.: 850-814/002-000 IP65 enclosure; Sheet steel (RAL 7035); WxHxD (200x120x200 mm); without flange plate</p>	 <p>Item No.: 850-815/002-000 IP65 enclosure; Sheet steel (RAL 7035); WxHxD (300x120x200 mm); without flange plate</p>

1.1.4.1 System enclosure



Item No.: [850-816/002-000](#)

IP65 enclosure; Sheet steel (RAL 7035);
WxHxD (400x120x200 mm); without flange plate

Item No.: [850-817/002-000](#)

IP65 enclosure; Sheet steel (RAL 7035);
WxHxD (600x120x200 mm); without flange plate