

Data Sheet | Item Number: 221-2535

Mounting carrier; 5-way; for inline splicing connector with lever; with snap-in mounting foot; gray

<https://www.wago.com/221-2535>

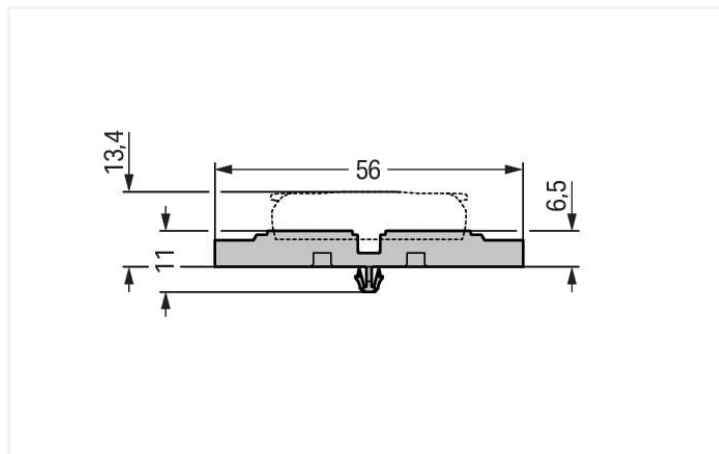
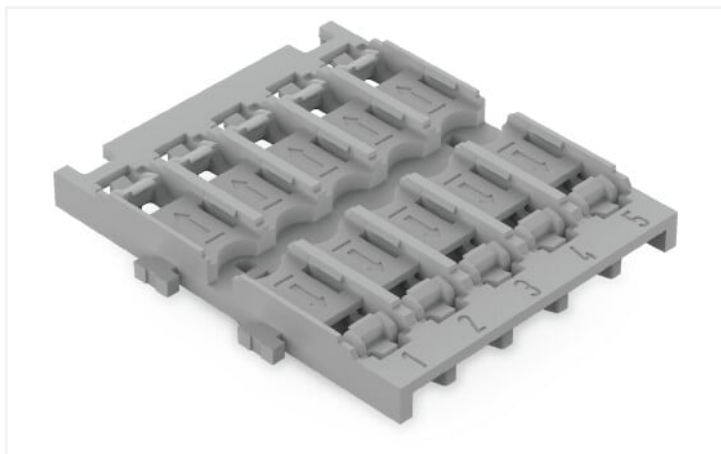

Color: ■ gray

Physical data

Width	47.8 mm / 1.882 inches
Height from the surface	6.5 mm / 0.256 inches
Depth	56 mm / 2.205 inches

Material data

Note (material data)	Information on material specifications can be found here
Color	gray
Fire load	0.232 MJ
Weight	7.7 g

Commercial data

ETIM 8.0	EC002848
ETIM 7.0	EC002848
PU (SPU)	25 (5) pcs
Packaging type	Box
Country of origin	CN
GTIN	4066966120011
Customs tariff number	39269097900

Environmental Product Compliance

RoHS Compliance Status	Compliant, No Exemption
------------------------	-------------------------

Downloads

Environmental Product Compliance

Compliance Search

Environmental Product Compliance 221-2535



CAD/CAE-Data

CAD data

2D/3D Models
221-2535



CAE data

EPLAN Data Portal
221-2535



ZUKEN Portal
221-2535



1 Compatible Products

1.1 Optional Accessories

1.1.1 Installation

1.1.1.1 Mounting accessories



Item No.: 209-119

Fixing screw; for 209-120 mounting carrier



Item No.: 209-123

Mounting foot with screw; can be screwed on terminal blocks with fixing flange; 6.4 mm wide; gray



Item No.: 209-120

Mounting foot; can be snapped on terminal blocks with snap-in mounting foot; for mounting on relay-modules; 6.4 mm wide; gray

1.1.2 Marking

1.1.2.1 Marking strip



Item No.: 210-834

Marking strips; on reel; 5 mm wide; plain; Self-adhesive; white

Installation Notes

Installation

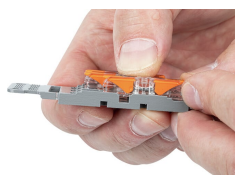

Place the inline splicing connector on the carrier in front of the mounting position.



Push the connector to the center position until it snaps into place.

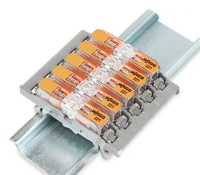

Mounting carrier without strain relief – snapped onto DIN-rail



Various combinations of 1- to 5-connector mounting carriers are possible via side-by-side latching mechanism.

Strain relief

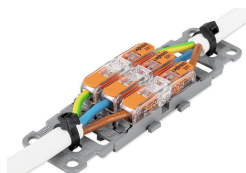

3-pole mounting carrier with strain relief