

		MBX...P SKI	MBX..N SKI/II MBX..P SKII
<b>1</b>		-	2x (N)
<b>2</b>		4x	4x
<b>3</b>		-	2x
<b>4</b>		-	4x

<b>5</b>		-	4x
<b>6</b>		-	4x
<b>7</b>		2x	2x (PE)
<b>8</b>		4x	4x
<b>9</b>		1x	1x

**ZX2720-..25**

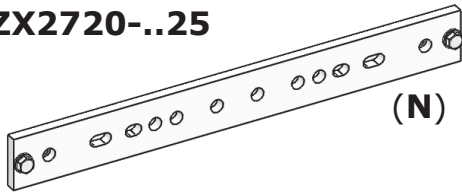

**ZX2740-..45**

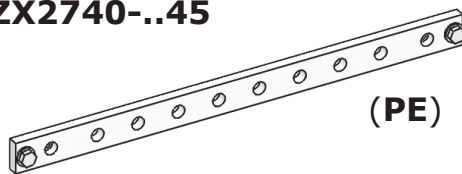

<b>1a</b>			1x
<b>2a</b>			2x
<b>3a</b>			2x

<b>1b</b>			1x
<b>2b</b>			2x
<b>3b</b>			2x

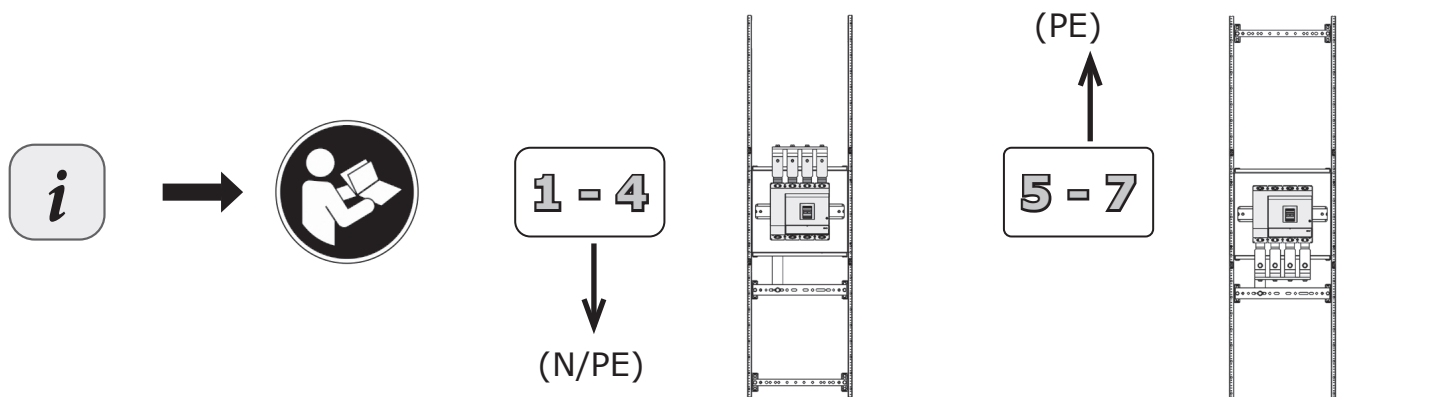

<a href="http://www.striebelundjohn.com">www.striebelundjohn.com</a>				T25/30	WR	ED

1

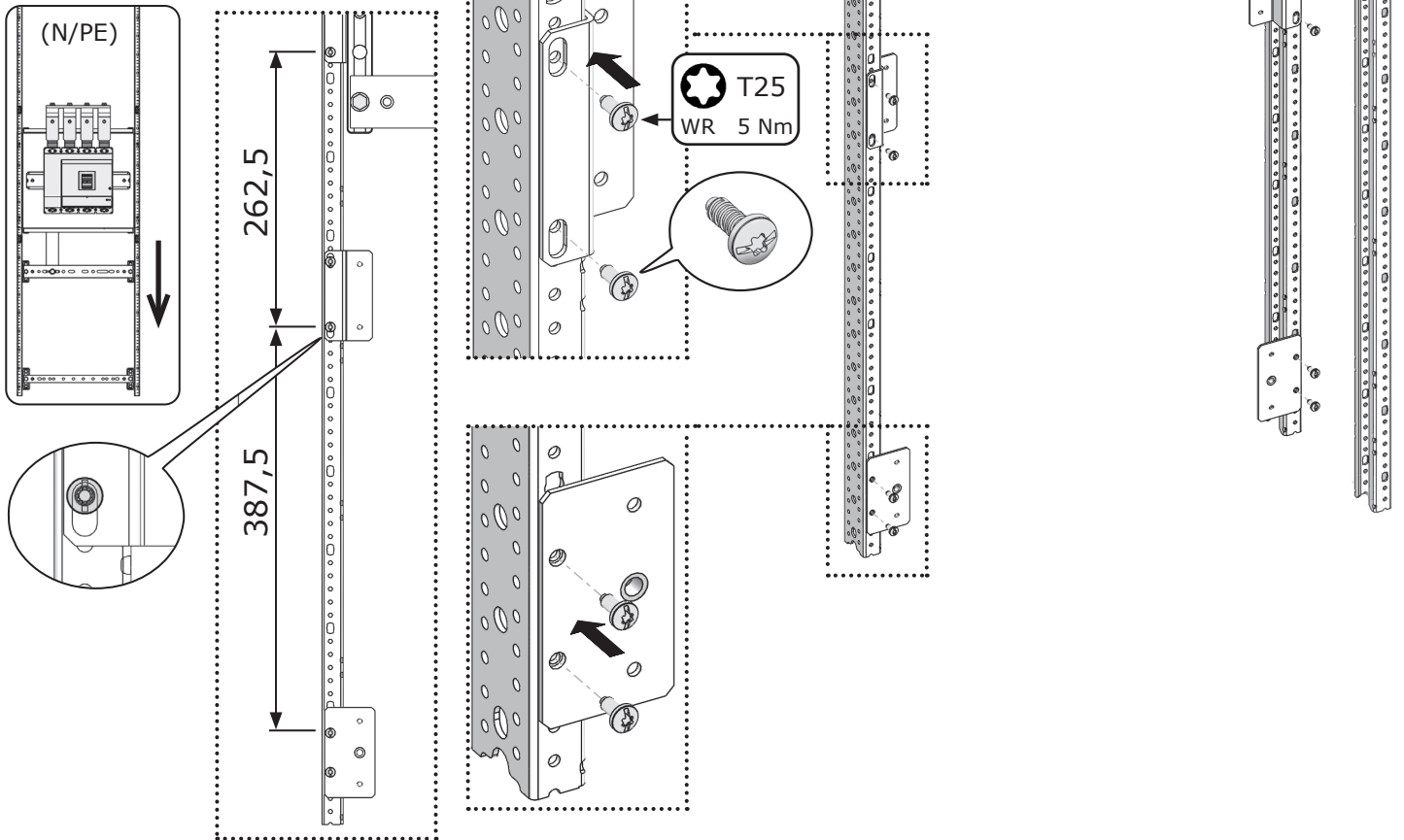

2

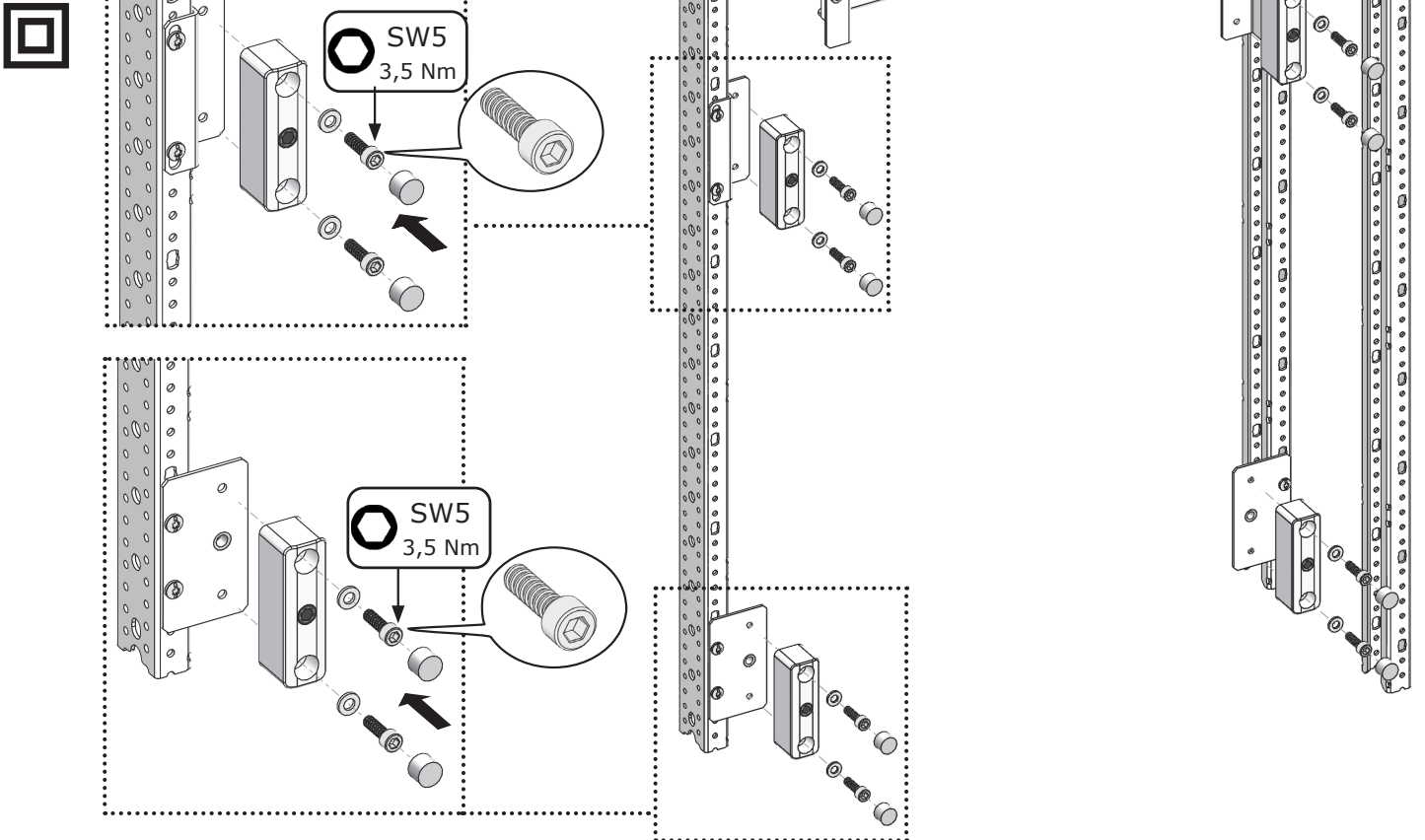

**3**

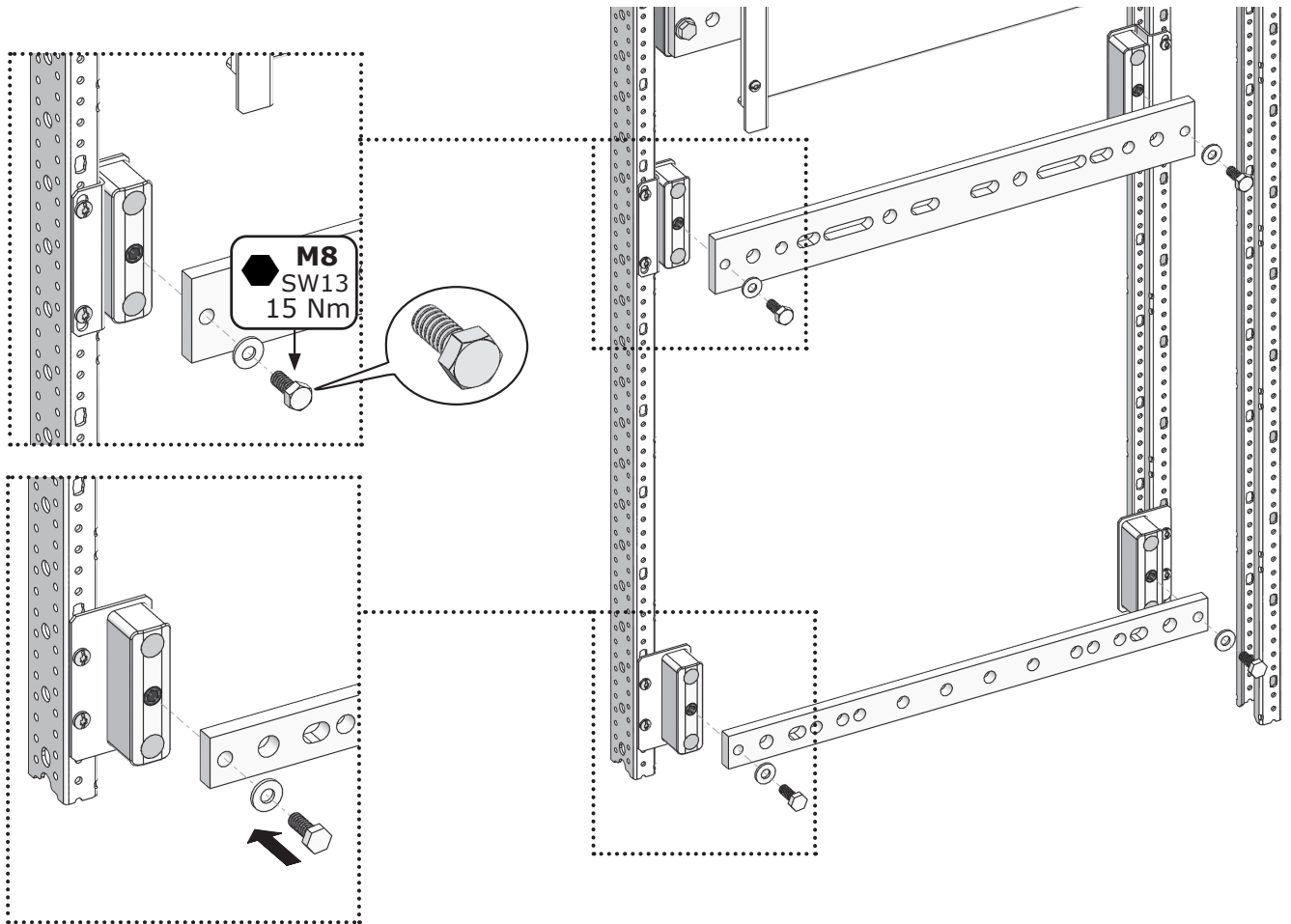

**4**

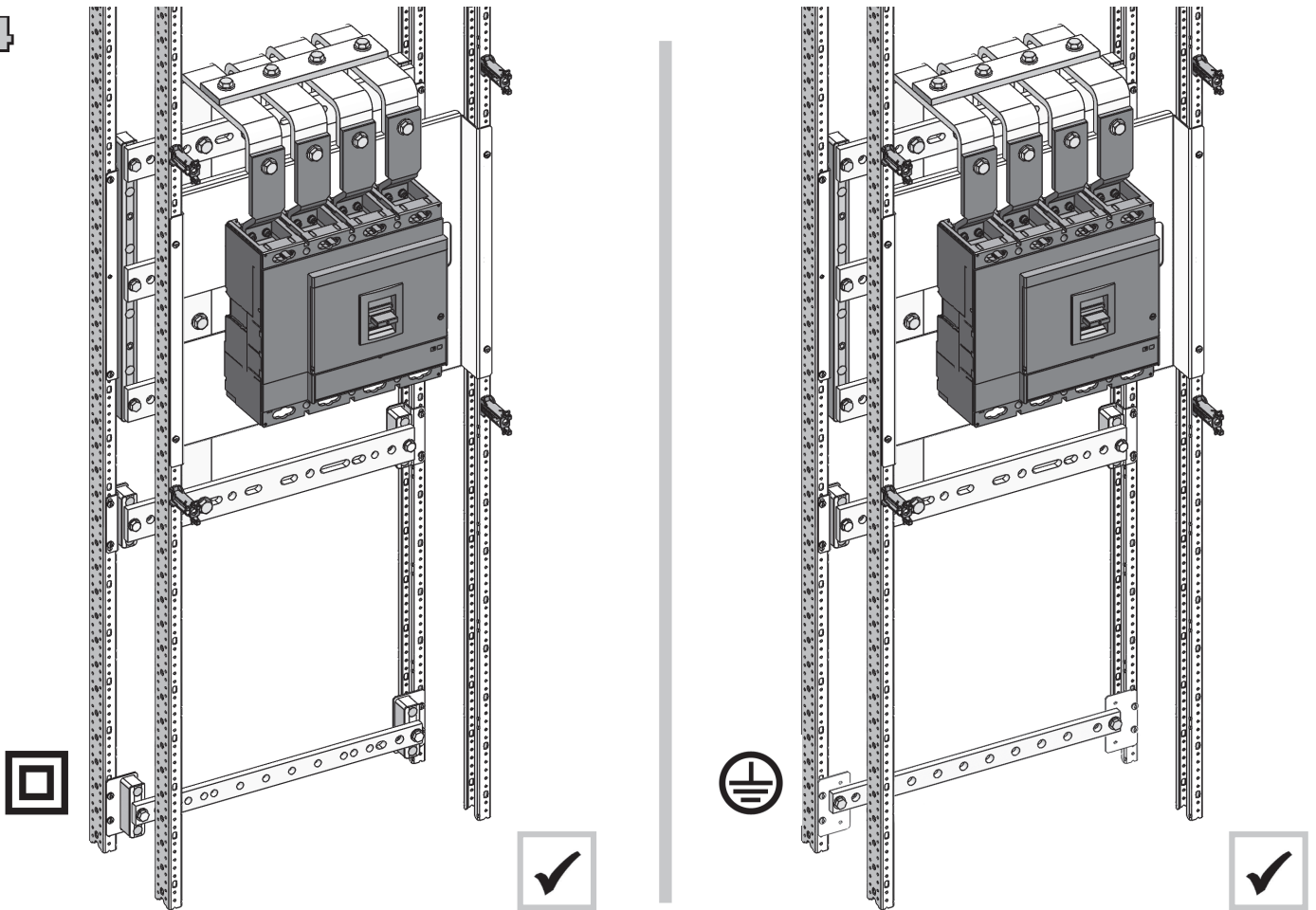

**5**

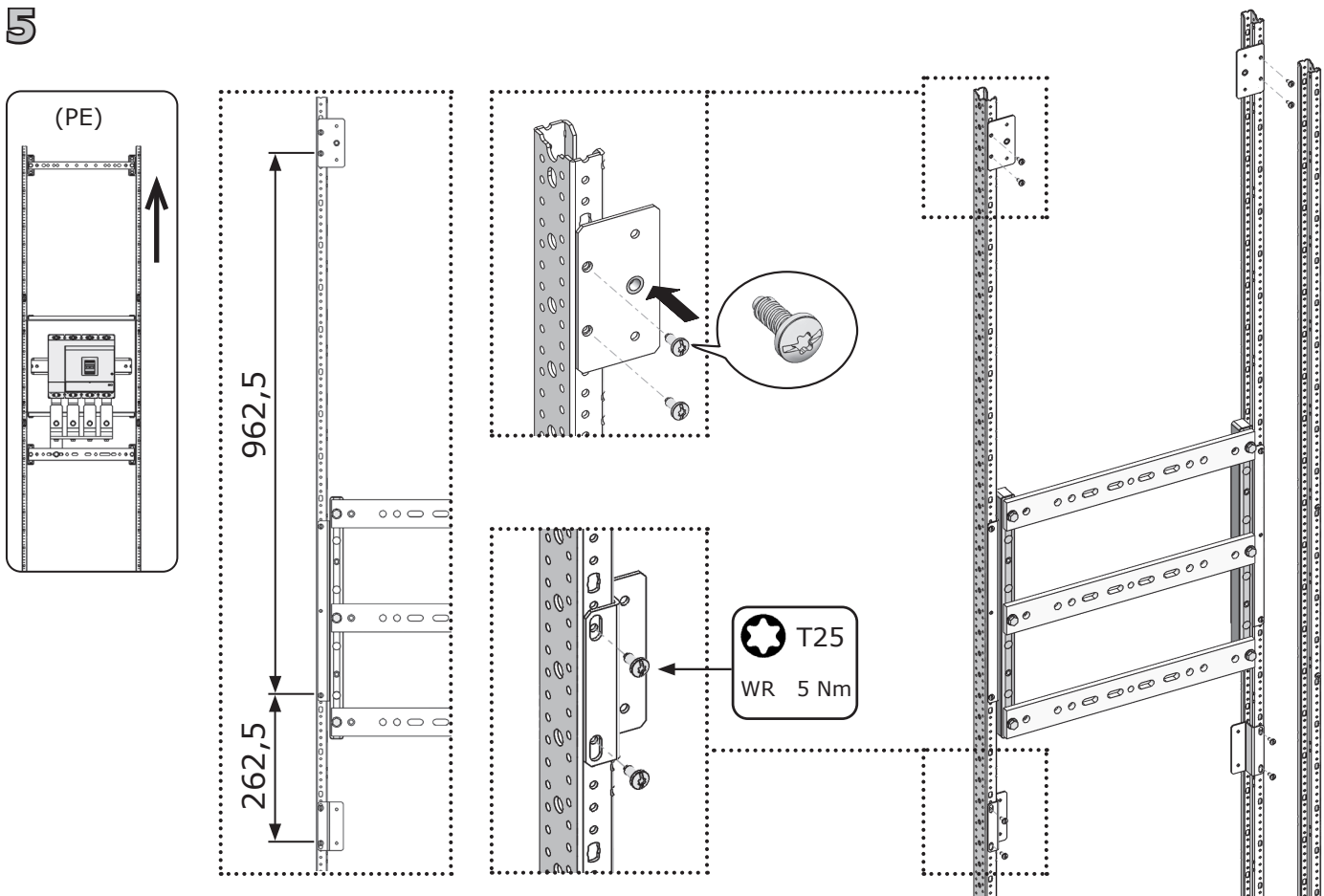

**6 / 7 = 2 / 3**

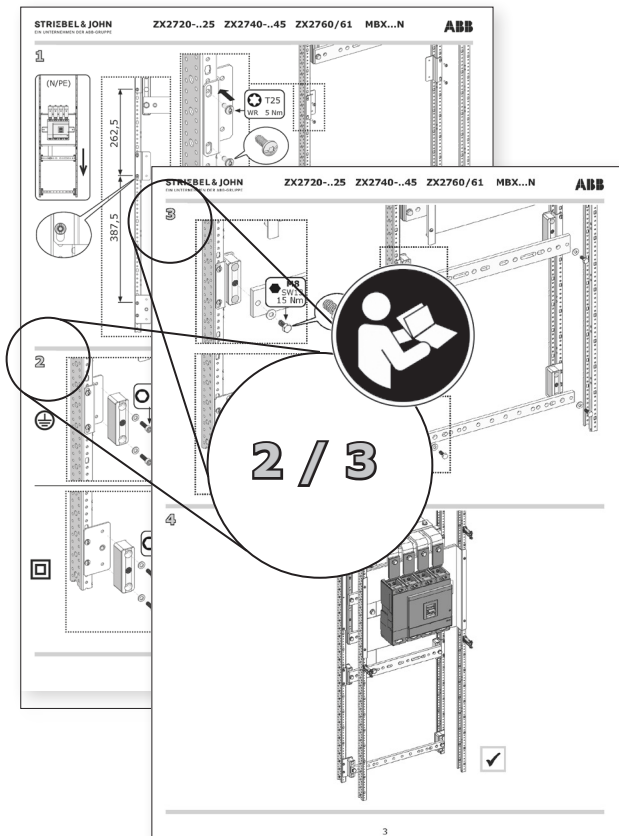

**8**

