

Color: ■ dark gray

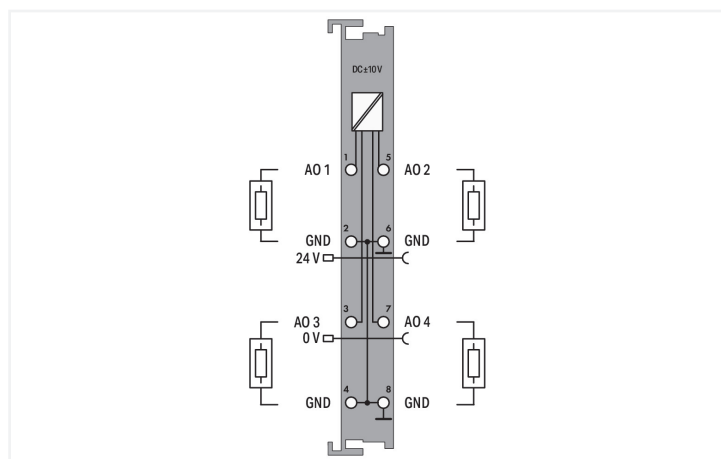
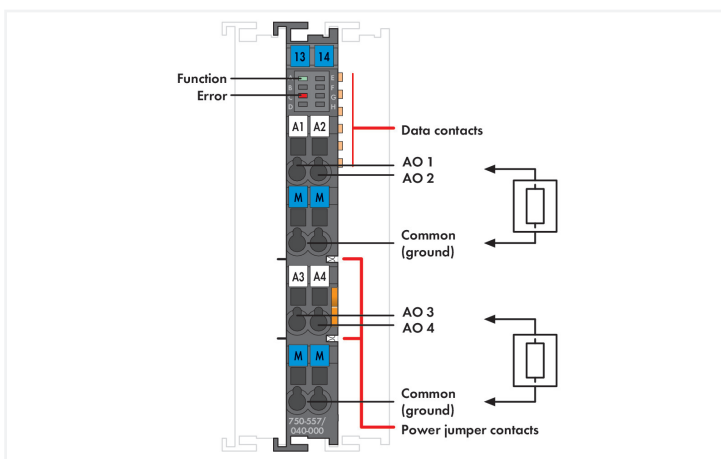

The analog output module generates standard  $\pm 10$  V signals.  
 The output signal is electrically isolated and transmitted with a resolution of 12 bits.  
 The internal system supply powers the module.  
 The module's output channels have a common ground potential.

**The device is ideal for operation in extreme environments thanks to:**

- An extended temperature range
- Greater immunity to impulse voltages and electromagnetic interference
- Higher vibration and shock resistance

**Technical data**

Number of analog outputs	4
Total number of channels (module)	4
Signal type	Voltage
Signal type (voltage)	-10 ... +10 VDC
Actuator connection	4 x (2-wire)
Resolution [bit]	12 bits
Data width	4 x 16-bit data; 4 x 8-bit control/status (optional)
Load impedance (voltage output)	$\geq 5$ k $\Omega$
Conversion time (typ.)	10 ms
Output error, reference temperature	25 °C

### Technical data

Output error, deviation (max.) of the upper-range value	0.1 %
Temperature error (max.) of the output range value	0.01 %/K
Recovery time (typ.)	100 ms
Supply voltage (system)	5 VDC; via data contacts
Current consumption (5 V system supply)	125 mA
Supply voltage (field)	24 VDC (-25 ... +30 %); via power jumper contacts (power supply via blade contact; transmission via spring contact); Derating must be observed!
Dielectric strength	510 VAC / 775 VDC; per EN 60870-2-1
Rated impulse withstand voltage	1 kV
Indicators	LED (A) green: Function; LED (C) red: Error
Number of incoming power jumper contacts	2
Number of outgoing power jumper contacts	2
Current carrying capacity (power jumper contacts)	10 A
Derating	Derating (supply voltage): Ambient temperatures under laboratory conditions: (-25 ... +30 %); for -40 ... +55 °C: 24 V (-25 ... +20 %); for +55 ... +70 °C: 24 V (-25 ... +10 %); Lower limit in all temperature ranges: -27.5 % (including 15 % residual ripple)

### Connection Data

Connection technology: I/O	8 x CAGE CLAMP®
Connectable conductor materials	Copper
Connection type	Inputs/outputs
Solid conductor	0.25 ... 2.5 mm <sup>2</sup> / 24 ... 14 AWG
Fine-stranded conductor	0.25 ... 2.5 mm <sup>2</sup> / 24 ... 14 AWG
Strip length	8 ... 9 mm / 0.31 ... 0.35 inches

### Physical data

Width	12 mm / 0.472 inches
Height	100 mm / 3.937 inches
Depth	67.8 mm / 2.669 inches
Depth from upper-edge of DIN-rail	60.6 mm / 2.386 inches

### Mechanical data

Mounting type	DIN-35 rail
---------------	-------------

### Material data

Color	dark gray
Housing material	Polycarbonate; polyamide 6.6
Fire load	0.944 MJ
Weight	51.4 g
Conformity marking	CE

### Environmental requirements

Ambient temperature (operation)	-40 ... +70 °C
Ambient temperature (installation)	-20 ... +70 °C
Ambient temperature (storage)	-40 ... +85 °C
Protection type	IP20
Pollution degree	2 per IEC 61131-2
Operating altitude	without temperature derating: 0 ... 2000 m; with temperature derating: 2000 ... 5000 m (0.5 K/100 m); 5000 m (max.)
Mounting position	Horizontal left, horizontal up, vertical top and vertical bottom
Relative humidity (without condensation)	95 %
Relative humidity (with condensation)	Short-term condensation per Class 3K7/IEC EN 60721-3-3 and E-DIN 40046-721-3 (except for wind-driven precipitation, water and ice formation)
Vibration resistance	According to type test for marine classification (ABS, BV, DNV, IACS, LR): acceleration: 5g, IEC 60068-2-6, EN 60870-2-2, IEC 60721-3-1, -3, EN 50155, EN 61373
Shock resistance	per IEC 60068-2-27 (10g/16 ms/half-sine/1,000 shocks; 25g/6 ms/half-sine/1,000 shocks), EN 50155, EN 61373
EMC immunity to interference	per EN 61000-6-1, -2; EN 61131-2; marine applications; EN 50121-3-2; EN 50121-4, -5; EN 60255-26; EN 60870-2-1; EN 61850-3; IEC 61000-6-5; IEEE 1613; VDEW: 1994
EMC emission of interference	per EN 61000-6-3, -4, EN 61131-2, EN 60255-26, marine applications, EN 60870-2-1, EN 61850-3, EN 50121-3-2, EN 50121-4, -5
Exposure to pollutants	per IEC 60068-2-42 and IEC 60068-2-43
Permissible H <sub>2</sub> S contaminant concentration at a relative humidity 75 %	10 ppm
Permissible SO <sub>2</sub> contaminant concentration at a relative humidity 75 %	25 ppm

### Commercial data

Product Group	15 (I/O System)
PU (SPU)	1 pcs
Packaging type	Box
Country of origin	DE
GTIN	4050821460350
Customs tariff number	85389099990

### Product Classification

UNSPSC	32101506
eCl@ss 10.0	27-24-26-01
eCl@ss 9.0	27-24-26-01
ETIM 9.0	EC001596
ETIM 10.0	EC001596
ECCN	NO US CLASSIFICATION

### Environmental Product Compliance

CAS-No.	1303-86-2 1317-36-8 7439-92-1
REACH Candidate List Substance	Diboron trioxide Lead Lead monoxide Perfluorobutane sulfonic acid (PFBS) and its salts
RoHS Compliance Status	Compliant, With Exemption
RoHS Exemption	6(c) 7(a) 7(c)-I 7(c)-II
SCIP notification number (Bulgaria)	7aef9d63-92e6-4998-b1c8-6acd9ead2c6a
SCIP notification number (Czech Republic)	360e8220-0e20-4789-9feb-39a6f9767fa3

Approvals / Certificates

General approvals



Approval	Standard	Certificate Name
EAC GZO Almaty Standart	TP TC 020/2011	EAC CoC 03083
KC National Radio Research Agency	Article 58-2, Clause 3	MSIP-REM-W43-AOM750
UL Underwriters Laboratories Inc. (ORDINARY LOCATIONS)	UL 508	E175199

Declarations of conformity and manufacturer's declarations

Approval	Standard	Certificate Name
EU-Declaration of Conformity WAGO GmbH & Co. KG	-	-
UK-Declaration of Conformity WAGO GmbH & Co. KG	-	-

Approvals for marine applications



Approval	Standard	Certificate Name
ABS American Bureau of Shipping	-	22-2208829-PDA
LR Lloyds Register	-	LR22276776TA
PRS Polski Rejestr Statków	-	TE/1099/880590/23

Approvals for hazardous areas



Approval	Standard	Certificate Name
ATEX TUEV Nord Cert GmbH	EN 60079-0	TUEV 17 ATEX 193969X (II 3 G Ex ec IIC T4 Gc)
CCC CNEX	CNCA-C23-01	2020312310000214 (Ex ec IIC T4 Gc)
IECEx TUEV Nord Cert GmbH	IEC 60079-0	IECEx TUN 16.0046X (Ex ec IIC T4 Gc)
UKEx WAGO GmbH & Co. KG	EN 60079-0	UKCA_WA GO22UKEX005X_ec
UL Underwriters Laboratories Inc. (HAZARDOUS LOCATIONS)	UL 121201	E198726

Downloads

Environmental Product Compliance

Compliance Search
Environmental Product Compliance 750-557/040-000 <a href="#">↓</a>

Documentation

Manual
Product Manual 4AO ±10 V DC /XTR   2476489099   3   en-US   2025-11-12 10:37   11.12.2025   pdf   1545.44 KB <a href="#">↓</a>

System Description
Overview on WAGO-I/O-SYSTEM 750 approvals   pdf   770.48 KB <a href="#">↓</a>
750 XTR Series I/O-System – General Product Information   pdf   726.09 KB <a href="#">↓</a>

Bid Text			
750-557/040-000	19.02.2019	xml 6.41 KB	<a href="#">↓</a>
750-557/040-000	28.10.2015	doc 28.00 KB	<a href="#">↓</a>

Instruction Leaflet			
CCC Ex (Additional information)	26.04.2023	pdf 144.58 KB	<a href="#">↓</a>









CAD/CAE-Data	
<b>CAD data</b> 2D/3D Models 750-557/040-000 <a href="#">↓</a>	<b>CAE data</b> EPLAN Data Portal 750-557/040-000 <a href="#">↓</a>  WSCAD Universe 750-557/040-000 <a href="#">↓</a>  ZUKEN Portal 750-557/040-000 <a href="#">↓</a>

## 1 Compatible Products

### 1.1 Optional Accessories

#### 1.1.1 DIN-rail

##### 1.1.1.1 Mounting accessories









 <b>Item No.: 210-196</b> Aluminum carrier rail; 35 x 8.2 mm; 1.6 mm thick; 2 m long; unslotted; similar to EN 60715; silver-colored	 <b>Item No.: 210-198</b> Copper carrier rail; 35 x 15 mm; 2.3 mm thick; 2 m long; unslotted; according to EN 60715; copper-colored	 <b>Item No.: 210-197</b> Steel carrier rail; 35 x 15 mm; 1.5 mm thick; 2 m long; slotted; similar to EN 60715; silver-colored	 <b>Item No.: 210-114</b> Steel carrier rail; 35 x 15 mm; 1.5 mm thick; 2 m long; unslotted; similar to EN 60715; silver-colored
 <b>Item No.: 210-118</b> Steel carrier rail; 35 x 15 mm; 2.3 mm thick; 2 m long; unslotted; according to EN 60715; silver-colored	 <b>Item No.: 210-115</b> Steel carrier rail; 35 x 7.5 mm; 1 mm thick; 2 m long; slotted; according to EN 60715; "Hole width 18 mm; silver-colored	 <b>Item No.: 210-112</b> Steel carrier rail; 35 x 7.5 mm; 1 mm thick; 2 m long; slotted; according to EN 60715; "Hole width 25 mm; silver-colored	 <b>Item No.: 210-113</b> Steel carrier rail; 35 x 7.5 mm; 1 mm thick; 2 m long; unslotted; according to EN 60715; silver-colored

### 1.1.2 Marking

#### 1.1.2.1 Group marker carrier

 <b>Item No.: 750-107</b> Group marker carrier
---

#### 1.1.2.2 Marker

 <b>Item No.: 2009-145/000-006</b> Mini-WSB In-line; for Smart Printer; 1700 pieces on roll; stretchable 5 - 5.2 mm; plain; snap-on type; blue	 <b>Item No.: 2009-145/000-007</b> Mini-WSB In-line; for Smart Printer; 1700 pieces on roll; stretchable 5 - 5.2 mm; plain; snap-on type; gray	 <b>Item No.: 2009-145/000-023</b> Mini-WSB In-line; for Smart Printer; 1700 pieces on roll; stretchable 5 - 5.2 mm; plain; snap-on type; green	 <b>Item No.: 2009-145/000-012</b> Mini-WSB In-line; for Smart Printer; 1700 pieces on roll; stretchable 5 - 5.2 mm; plain; snap-on type; orange
 <b>Item No.: 2009-145/000-005</b> Mini-WSB In-line; for Smart Printer; 1700 pieces on roll; stretchable 5 - 5.2 mm; plain; snap-on type; red	 <b>Item No.: 2009-145/000-024</b> Mini-WSB In-line; for Smart Printer; 1700 pieces on roll; stretchable 5 - 5.2 mm; plain; snap-on type; violet	 <b>Item No.: 2009-145</b> Mini-WSB In-line; for Smart Printer; 1700 pieces on roll; stretchable 5 - 5.2 mm; plain; snap-on type; white	 <b>Item No.: 2009-145/000-002</b> Mini-WSB In-line; for Smart Printer; 1700 pieces on roll; stretchable 5 - 5.2 mm; plain; snap-on type; yellow

1.1.2.2 Marker



**Item No.: 248-501/000-006**

Mini-WSB marking card; as card; not stretchable; plain; snap-on type; blue



**Item No.: 248-501/000-007**

Mini-WSB marking card; as card; not stretchable; plain; snap-on type; gray



**Item No.: 248-501/000-023**

Mini-WSB marking card; as card; not stretchable; plain; snap-on type; green



**Item No.: 248-501/000-017**

Mini-WSB marking card; as card; not stretchable; plain; snap-on type; light green



**Item No.: 248-501/000-012**

Mini-WSB marking card; as card; not stretchable; plain; snap-on type; orange



**Item No.: 248-501/000-005**

Mini-WSB marking card; as card; not stretchable; plain; snap-on type; red



**Item No.: 248-501/000-024**

Mini-WSB marking card; as card; not stretchable; plain; snap-on type; violet



**Item No.: 248-501**

Mini-WSB marking card; as card; not stretchable; plain; snap-on type; white



**Item No.: 248-501/000-002**

Mini-WSB marking card; as card; not stretchable; plain; snap-on type; yellow

1.1.2.3 Marker carrier



**Item No.: 750-103**

Group marker carrier

1.1.3 Shield termination

1.1.3.1 Shield clamping saddles



**Item No.: 790-108**

Shield clamping saddle; 11 mm wide; diameter of compatible conductor; 3 ... 8 mm



**Item No.: 790-208**

Shield clamping saddle; 12.4 mm wide; 3 ... 8 mm



**Item No.: 790-116**

Shield clamping saddle; 19 mm wide; diameter of compatible conductor; 7 ... 16 mm



**Item No.: 790-216**

Shield clamping saddle; 21.8 mm wide; 6 ... 16 mm



**Item No.: 790-124**

Shield clamping saddle; 27 mm wide; diameter of compatible conductor; 6 ... 24 mm



**Item No.: 790-220**

Shield clamping saddle; 30 mm wide; 6 ... 20 mm



**Item No.: 790-140**

Shield clamping saddle; diameter of compatible conductor

1.1.4 System enclosure

1.1.4.1 System enclosure



**Item No.: 850-825**

IP65 enclosure; Aluminium (RAL 7032); WxHxD (160x100x160 mm); 9 x M12, 4 x M20



**Item No.: 850-826**

IP65 enclosure; Aluminium (RAL 7032); WxHxD (240x100x160 mm); 4 x M20, 4 x M16, 14 x M12 cable grip



**Item No.: 850-827**

IP65 enclosure; Aluminium (RAL 7032); WxHxD (320x100x160 mm); 4 x M20, 8 x M16, 17 x M12 cable grip



**Item No.: 850-828**

IP65 enclosure; Aluminium (RAL 7032); WxHxD (480x100x160 mm); 4 x M20, 10 x M16, 35 x M12 cable grip



**Item No.: 850-826/002-000**

IP65 enclosure; Aluminium (RAL 7035); WxHxD (240x100x160 mm); 4 x M20, 4 x M16, 14 x M12 cable grip



**Item No.: 850-827/002-000**

IP65 enclosure; Aluminium (RAL 7035); WxHxD (320x100x160 mm); 4 x M20, 8 x M16, 17 x M12 cable grip



**Item No.: 850-828/002-000**

IP65 enclosure; Aluminium (RAL 7035); WxHxD (480x100x160 mm); 4 x M20, 10 x M16, 35 x M12 cable grip



**Item No.: 850-834**

IP65 enclosure; Polyester (RAL 7032); WxHxD (164x100x164 mm); 9 x M12, 4 x M20



**Item No.: 850-835**

IP65 enclosure; Polyester (RAL 7032); WxHxD (244x100x164 mm); 4 x M20, 4 x M16, 14 x M12 cable grip



**Item No.: 850-836**

IP65 enclosure; Polyester (RAL 7032); WxHxD (324x100x164 mm); 4 x M20, 8 x M16, 17 x M12 cable grip



**Item No.: 850-814/002-000**

IP65 enclosure; Sheet steel (RAL 7035); WxHxD (200x120x200 mm); without flange plate



**Item No.: 850-815/002-000**

IP65 enclosure; Sheet steel (RAL 7035); WxHxD (300x120x200 mm); without flange plate

### 1.1.4.1 System enclosure



**Item No.: [850-816/002-000](#)**

IP65 enclosure; Sheet steel (RAL 7035);  
WxD (400x120x200 mm); without flange plate

**Item No.: [850-817/002-000](#)**

IP65 enclosure; Sheet steel (RAL 7035);  
WxD (600x120x200 mm); without flange plate