

Data Sheet | Item Number: 2000-2258/099-000

Double-deck terminal block; Shield/through terminal block; with end plate; 1 mm²; Shielding/L; with marker carrier; for DIN-rail 35 x 15 and 35 x 7.5; Push-in CAGE CLAMP®; 1,00 mm²; gray

<https://www.wago.com/2000-2258/099-000>

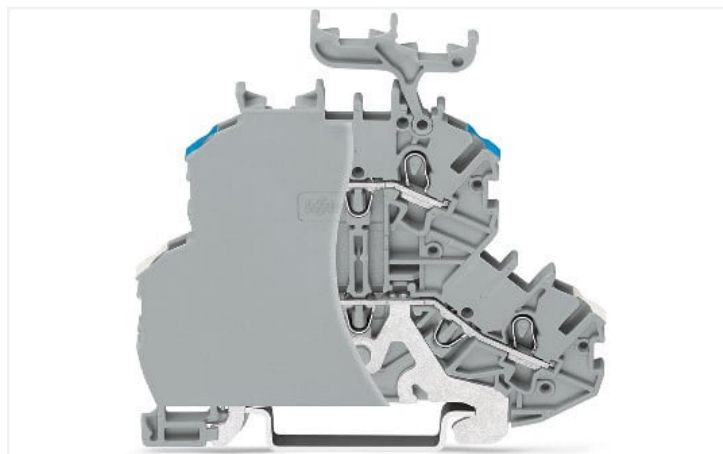

Color: ■ gray

Similar to illustration

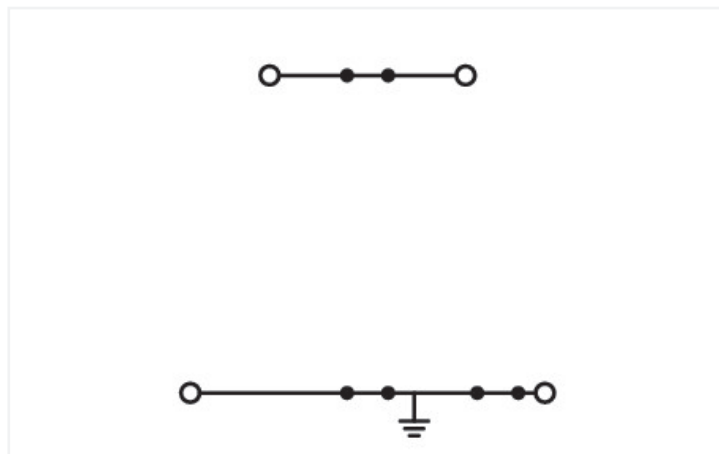

Similar to illustration

Electrical data

Ratings per	IEC/EN 60947-7-1		
Overvoltage category	III	III	II
Pollution degree	3	2	2
Nominal voltage	800 V	-	-
Rated surge voltage	8 kV	-	-
Rated current	16 A	-	-
Current at conductor cross-section (max.) mm ²	18 A	-	-

Approvals per	UL 1059		
Use group	B	C	D
Rated voltage	600 V	600 V	-
Rated current	15 A	15 A	-

Approvals per	CSA 22.2 No 158		
Use group	B	C	D
Rated voltage	600 V	600 V	-
Rated current	10 A	-	-

Ex information	
Ratings per	ATEX: PTB 11 ATEX 1041 U / IECEx: PTB 11.0093U (Ex eb IIC Gb)
Rated voltage EN (Ex e II)	550 V
Rated current (Ex e II)	13 A
Rated current (Ex e II) with jumper	12 A

Power Loss

Power loss, per pole (potential)	0.8675 W
Rated current I _N for specified power loss	13.5 A
Resistance value for specified, current-dependent power loss	0.00238 Ω

Connection data

Connection points	4
Total number of potentials	2
Number of levels	2
Number of jumper slots	4
Number of jumper slots (rank)	1

Connection 1

Connection technology	Push-in CAGE CLAMP®
Number of connection points	2
Actuation type	Operating tool
Connectable conductor materials	Copper
Nominal cross-section	1 mm ²
Solid conductor	0.14 ... 1.5 mm ² / 24 ... 16 AWG
Solid conductor; push-in termination	0.5 ... 1.5 mm ² / 20 ... 16 AWG
Fine-stranded conductor	0.14 ... 1.5 mm ² / 24 ... 16 AWG
Fine-stranded conductor; with insulated ferrule	0.14 ... 0.75 mm ² / 24 ... 18 AWG
Fine-stranded conductor; with ferrule; push-in termination	0.5 ... 0.75 mm ² / 20 ... 18 AWG
Note (conductor cross-section)	Depending on the conductor characteristic, a conductor with a smaller cross-section can also be inserted via push-in termination.
Strip length	9 ... 11 mm / 0.35 ... 0.43 inches
Wiring direction	Front-entry wiring

Connection 2

Number of connection points 2	2
-------------------------------	---

Physical data

Width	4.2 mm / 0.165 inches
Height	69.7 mm / 2.744 inches
Depth from upper-edge of DIN-rail	61.8 mm / 2.433 inches

Mechanical data

Potential marking	Shield/L
Mounting type	DIN-35 rail
Marking level	Center/side marking

Material data

Note (material data)	Information on material specifications can be found here
Color	gray
Material group	I
Insulation material	Polyamide (PA66)
Flammability class per UL94	V0
Fire load	0.227 MJ
Weight	11.8 g

Environmental requirements

Processing temperature	-35 ... +85 °C
Continuous operating temperature	-60 ... +105 °C

Commercial data

Product Group	22 (TOPJOB S)
eCl@ss 10.0	27-14-11-41
eCl@ss 9.0	27-14-11-41
ETIM 8.0	EC000901
ETIM 7.0	EC000901
PU (SPU)	50 pcs
Packaging type	Box
Country of origin	DE
GTIN	4050821037774
Customs tariff number	85369010000

Environmental Product Compliance

RoHS Compliance Status	Compliant, No Exemption
------------------------	-------------------------

Approvals / Certificates

General approvals



Approval	Standard	Certificate Name
CCA DEKRA Certification B.V.	EN 60947	NTR NL 7962
KEMA/KEUR DEKRA Certification B.V.	EN 60947	71-125928
UL Underwriters Laboratories Inc.	UL 1059	E45172

Declarations of conformity and manufacturer's declarations



Approval	Standard	Certificate Name
EU-Declaration of Conformity WAGO GmbH & Co. KG	-	-
Railway WAGO GmbH & Co. KG	-	Railway Ready
UK-Declaration of Conformity WAGO GmbH & Co. KG	-	-

Approvals for hazardous areas



Approval	Standard	Certificate Name
AEx Underwriters Laboratories Inc.	UL 60079	E185892 (AEx eb IIC resp. Ex eb IIC)
EAC Brjansker Zertifizierungsstelle	TP TC 012/2011	RU C-DE.AM02. B.00127/19 (Ex e IIC Gb U)

Downloads

Environmental Product Compliance

Compliance Search

Environmental Product Compliance
2000-2258/099-000



Documentation

Additional Information

Technical Section

pdf
2240.62 KB



Bid Text

2000-2258/099-000

19.02.2019

xml
3.88 KB



2000-2258/099-000

07.08.2018

docx
14.92 KB



CAD/CAE-Data

CAD data

2D/3D Models
2000-2258/099-000



CAE data

EPLAN Data Portal
2000-2258/099-000



WSCAD Universe
2000-2258/099-000



ZUKEN Portal
2000-2258/099-000



1 Compatible Products

1.1 Optional Accessories

1.1.1 DIN-rail

1.1.1.1 Mounting accessories



Item No.: 210-196

Aluminum carrier rail; 35 x 8.2 mm; 1.6 mm thick; 2 m long; unslotted; similar to EN 60715; silver-colored



Item No.: 210-198

Copper carrier rail; 35 x 15 mm; 2.3 mm thick; 2 m long; unslotted; according to EN 60715; copper-colored



Item No.: 210-197

Steel carrier rail; 35 x 15 mm; 1.5 mm thick; 2 m long; slotted; similar to EN 60715; silver-colored



Item No.: 210-114

Steel carrier rail; 35 x 15 mm; 1.5 mm thick; 2 m long; unslotted; similar to EN 60715; silver-colored



Item No.: 210-118

Steel carrier rail; 35 x 15 mm; 2.3 mm thick; 2 m long; unslotted; according to EN 60715; silver-colored



Item No.: 210-115

Steel carrier rail; 35 x 7.5 mm; 1 mm thick; 2 m long; slotted; according to EN 60715; "Hole width 18 mm; silver-colored



Item No.: 210-112

Steel carrier rail; 35 x 7.5 mm; 1 mm thick; 2 m long; slotted; according to EN 60715; "Hole width 25 mm; silver-colored



Item No.: 210-113

Steel carrier rail; 35 x 7.5 mm; 1 mm thick; 2 m long; unslotted; according to EN 60715; silver-colored

1.1.2 Ferrule

1.1.2.1 Ferrule



Item No.: 216-241

Ferrule; Sleeve for 0.5 mm² / 20 AWG; insulated; electro-tin plated; electrolytic copper; gastight crimped; acc. to DIN 46228, Part 4/09.90; white

Item No.: 216-242

Ferrule; Sleeve for 0.75 mm² / 18 AWG; insulated; electro-tin plated; electrolytic copper; gastight crimped; acc. to DIN 46228, Part 4/09.90; gray

Item No.: 216-243

Ferrule; Sleeve for 1 mm² / AWG 18; insulated; electro-tin plated; electrolytic copper; gastight crimped; acc. to DIN 46228, Part 4/09.90; red

1.1.3 Installation

1.1.3.1 Cover



Item No.: 709-156

Cover; Type 3; suitable for cover carrier, type 3; 1 m long; transparent

1.1.3.2 Cover carrier



Item No.: 709-169

Cover carrier; Type 3; incl. fixing/retaining screws and knurled nut; suitable for 279 to 282 and 880 Series rail-mounted terminal blocks; suitable for 264 Series miniature rail-mounted terminal blocks; suitable for 270 Series sensor and actuator terminal blocks; gray

1.1.4 Jumper

1.1.4.1 Jumper



Item No.: 2001-406/020-000

Delta jumper; insulated; light gray



Item No.: 2001-410

Jumper; 10-way; insulated; light gray



Item No.: 2001-402

Jumper; 2-way; insulated; light gray



Item No.: 2001-403

Jumper; 3-way; insulated; light gray



Item No.: 2001-404

Jumper; 4-way; insulated; light gray



Item No.: 2001-405

Jumper; 5-way; insulated; light gray



Item No.: 2001-406

Jumper; 6-way; insulated; light gray



Item No.: 2001-407

Jumper; 7-way; insulated; light gray



Item No.: 2001-408

Jumper; 8-way; insulated; light gray



Item No.: 2001-409

Jumper; 9-way; insulated; light gray



Item No.: 2001-440

Jumper; from 1 to 10; insulated; light gray



Item No.: 2001-433

Jumper; from 1 to 3; insulated; light gray



Item No.: 2001-434

Jumper; from 1 to 4; insulated; light gray



Item No.: 2001-435

Jumper; from 1 to 5; insulated; light gray



Item No.: 2001-436

Jumper; from 1 to 6; insulated; light gray



Item No.: 2001-437

Jumper; from 1 to 7; insulated; light gray



Item No.: 2001-438

Jumper; from 1 to 8; insulated; light gray



Item No.: 2001-439

Jumper; from 1 to 9; insulated; light gray



Item No.: 2001-405/011-000

Star point jumper; 3-way; insulated; light gray



Item No.: 2000-492

Vertical jumper; insulated; light gray



Item No.: 210-103

Wire commoning chain; insulated; black



Item No.: 210-123

Wire commoning chain; insulated; blue

1.1.5 Marking

1.1.5.1 Marker



Item No.: 793-4501/000-006

WMB marking card; as card; stretchable 4 - 4.2 mm; plain; snap-on type; blue



Item No.: 793-4501/000-014

WMB marking card; as card; stretchable 4 - 4.2 mm; plain; snap-on type; brown



Item No.: 793-4501/000-007

WMB marking card; as card; stretchable 4 - 4.2 mm; plain; snap-on type; gray



Item No.: 793-4501/000-023

WMB marking card; as card; stretchable 4 - 4.2 mm; plain; snap-on type; green



Item No.: 793-4501/000-017

WMB marking card; as card; stretchable 4 - 4.2 mm; plain; snap-on type; light green



Item No.: 793-4501/000-012

WMB marking card; as card; stretchable 4 - 4.2 mm; plain; snap-on type; orange



Item No.: 793-4501/000-005

WMB marking card; as card; stretchable 4 - 4.2 mm; plain; snap-on type; red



Item No.: 793-4501/000-024

WMB marking card; as card; stretchable 4 - 4.2 mm; plain; snap-on type; violet



Item No.: 793-4501

WMB marking card; as card; stretchable 4 - 4.2 mm; plain; snap-on type; white



Item No.: 793-4501/000-002

WMB marking card; as card; stretchable 4 - 4.2 mm; plain; snap-on type; yellow



Item No.: 2009-114/000-006

WMB-Inline; for Smart Printer; 2000 pieces on roll; stretchable 4 - 4.2 mm; plain; snap-on type; blue



Item No.: 2009-114/000-007

WMB-Inline; for Smart Printer; 2000 pieces on roll; stretchable 4 - 4.2 mm; plain; snap-on type; gray



Item No.: 2009-114/000-023

WMB-Inline; for Smart Printer; 2000 pieces on roll; stretchable 4 - 4.2 mm; plain; snap-on type; green



Item No.: 2009-114/000-012

WMB-Inline; for Smart Printer; 2000 pieces on roll; stretchable 4 - 4.2 mm; plain; snap-on type; orange



Item No.: 2009-114/000-005

WMB-Inline; for Smart Printer; 2000 pieces on roll; stretchable 4 - 4.2 mm; plain; snap-on type; red



Item No.: 2009-114/000-024

WMB-Inline; for Smart Printer; 2000 pieces on roll; stretchable 4 - 4.2 mm; plain; snap-on type; violet



Item No.: 2009-114

WMB-Inline; for Smart Printer; 2000 pieces on roll; stretchable 4 - 4.2 mm; plain; snap-on type; white



Item No.: 2009-114/000-002

WMB-Inline; for Smart Printer; 2000 pieces on roll; stretchable 4 - 4.2 mm; plain; snap-on type; yellow

1.1.5.2 Marking strip



Item No.: 2009-110

Marking strips; for Smart Printer; on reel; not stretchable; plain; snap-on type; white

1.1.6 Protective warning marker

1.1.6.1 Cover



Item No.: 2001-115

Protective warning marker; for 5 terminal blocks; with high-voltage symbol, black; yellow

1.1.7 Push-in type wire jumper

1.1.7.1 Jumper



Item No.: 2009-404

Push-in type wire jumper; 0.75 mm²; insulated; 110 mm long; gray



Item No.: 2009-406

Push-in type wire jumper; 0.75 mm²; insulated; 250 mm long; gray



Item No.: 2009-402

Push-in type wire jumper; 0.75 mm²; insulated; 60 mm long; gray

1.1.8 Screwless end stop

1.1.8.1 Mounting accessories



Item No.: 249-117

Screwless end stop; 10 mm wide; for DIN-rail 35 x 15 and 35 x 7.5; gray



Item No.: 249-116

Screwless end stop; 6 mm wide; for DIN-rail 35 x 15 and 35 x 7.5; gray

1.1.9 Test and measurement

1.1.9.1 Testing accessories



Item No.: 2009-174

Test plug adapter; for 4 mm Ø test plugs; for testing TOPJOB®S rail-mounted terminal blocks; gray



Item No.: 2009-182

Testing tap; for max. 2.5 mm²; tool-free connection for individual test wires 0.08 - 2.5 mm; gray

1.1.10 Tool

1.1.10.1 Operating tool



Item No.: 210-719

Operating tool; Blade: 2.5 x 0.4 mm; with a partially insulated shaft



Item No.: 210-648

Operating tool; Blade: 2.5 x 0.4 mm; with a partially insulated shaft; angled; short



Item No.: 210-647

Operating tool; Blade: 2.5 x 0.4 mm; with a partially insulated shaft; multicoloured

Installation Notes

Conductor termination

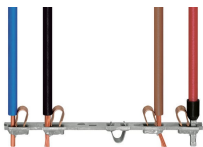

All conductor types at a glance

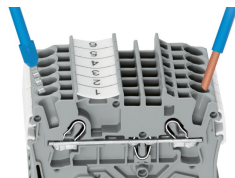

Push-in termination of solid and ferruled conductors

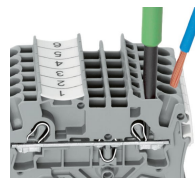

Inserting a conductor via operating tool:

Connecting fine-stranded conductors without ferrules, or small cross-sectional conductors that cannot be pushed in, is performed similarly to the original CAGE CLAMP® – just use an operating tool.

Advantage:

To open the clamp, the operating tool is inserted vertically. The conductor entry is less than 15 degrees for easier wiring.

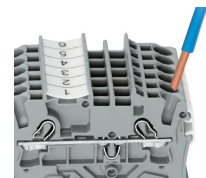

Inserting a conductor via push-in termination:

Solid conductors with cross-sections from either one size above, or up to two sizes below, the rated cross-section can be simply pushed in – no tools needed.

Conductor termination

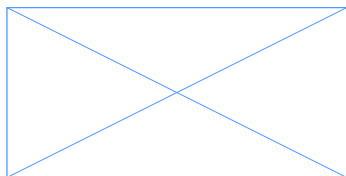

Conductor termination – insulation stop

Commoning

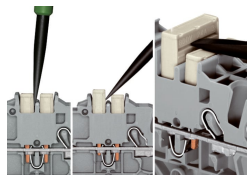

Removing a push-in type jumper bar:
Insert the operating tool between the jumper and partition wall of the dual jumper slots, then lift up the jumper. Place the operating tool in the center of jumpers for up to five contacts (see above), or alternately on both sides for jumpers with more than five contacts.

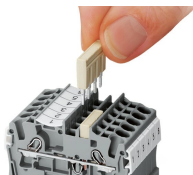

Insert push-in type jumper bar and push down until it hits backstop.

Commoning

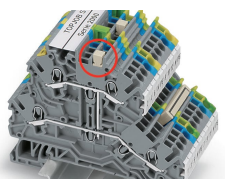

Commoning two levels via double-deck vertical jumper (2000-492).

Marking

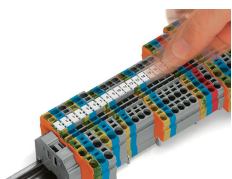

Snapping WMB Inline markers into marker slots.

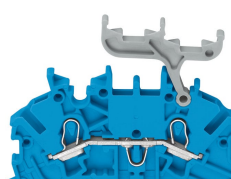
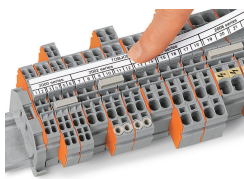

Double-Deck Terminal Blocks
A double-deck marker carrier (2000-121) can be retrofitted to double-deck terminal blocks without a marker carrier.

