

# Productinformatieblad

Specificaties



## Signaallamp, Rond, Ø22mm, IP65, LED, 230-240V, Oranje

XB4BVM5

**Belangrijk bericht:** A change in appearance may be noted on the product but does not affect its use in terms of function and safety. This makes it compatible with our Universal LED blocks  
EAN Code: 3389110892024

**Prijs: 27,50 EUR**

### Hoofd

range of product	Harmony XB4
product of component type	Controlelampje
device short name	XB4
kraag materiaal	Verchroomd metaal
materiaal bevestigingskraag	Zamak
bevestigingsdiameter	22,5 mm
koptype	Standaard
verkoop per ondeelbare hoeveelheid	1
vorm van kop signaleringseenheid	Rond
kap/operator of lenskleur	Oranje
extra informatie operator	Met gewone lens
lichtbron	Universele LED
lamp fitting	Integrale LED
kleur lichtbron	Oranje
Us nominale voedingsspanning	230...240 V AC 50/60 Hz

### Complementair

hoogte	47 mm
breedte	30 mm
diepte	54 mm
beschrijving klemmen ISO n°1	(X1-X2)PL
gewicht product	0,08 kg
weerstand hoge druk drukring	7000000 Pa om 55 °C, afstand: 0.1 m
aansluitingen - aansluitklemmen	Schroefklem aansluitingen, <= 2 x 1,5 mm <sup>2</sup> met kabeluiteinde In overeenstemming met IEC 60947-1 Schroefklem aansluitingen, 1 x 0,22...2 x 2,5 mm <sup>2</sup> zonder kabeluiteinde In overeenstemming met IEC 60947-1
Ui nom isolatiespanning	250 V (vervuilingsgraad) 3) In overeenstemming met IEC 60947-1
Uimp nom. schokgolfspanning	4 kV In overeenstemming met IEC 60947-1
type signalering	Vast
stroomverbruik	14 mA

De weergegeven prijs is de adviesprijs in euro excl. BTW. Deze kan onderhevig zijn aan korting. Neem contact op met uw lokale distributeur of detailhandel voor de daadwerkelijke prijs

levensduur	100000 h bij nominale spanning en 25 °C
bestand tegen stroompieken	1 kV In overeenstemming met IEC 61000-4-5
product presentatie	Compleet product
voedingsspanningsgrenzen	195...264 V AC

## Omgeving

beschermende behandeling	TH
ambient air temperature for storage	-40...70 °C
omgevingstemperatuur voor werking	-40...70 °C
beschermingsklasse tegen elektrische schokken	Klasse I In overeenstemming met IEC 60536
IP beschermingsgraad	IP66 In overeenstemming met IEC 60529 IP67 IP69 IP69K
Enclosure Type	UL type 4X/13
IK-beschermingsgraad	IK06 In overeenstemming met IEC 50102
standards	IEC 60947-1 IEC 60947-5-1 UL 508 CSA C22.2 Nr 14 IEC 60947-5-5 IEC 60947-5-4 JIS C8201-5-1 JIS C8201-1
product certifications	CSA UL listed
trilling bestendigheid	5 gn (f= 12...500 Hz) In overeenstemming met IEC 60068-2-6
schokbestendigheid	30 gn (duur = 18 ms) voor halve sinusgolf versnelling In overeenstemming met IEC 60068-2-27 50 gn (duur = 11 ms) voor halve sinusgolf versnelling In overeenstemming met IEC 60068-2-27
weerstand tegen snelle piekspanningen	2 kV In overeenstemming met IEC 61000-4-4
weerstand tegen elektromagnetische velden	10 V/m In overeenstemming met IEC 61000-4-3
weerstand tegen elektrostatische ontlading	6 kV op contact (op metalen onderdelen) In overeenstemming met IEC 61000-4-2 8 kV in open lucht (in isolerende onderdelen) In overeenstemming met IEC 61000-4-2
elektromagnetische emissie	Klasse B In overeenstemming met IEC 55011

## Verpakkingseenheid

Eenheidstype van verpakking 1	PCE
Aantal eenheden in verpakking 1	1
verpakking 1 hoogte	8,800 cm
verpakking 1 breedte	3,400 cm
verpakking 1 lengte	5,400 cm
verpakking_1_gewicht	79,000 g
Eenheidstype van verpakking 2	S03
Aantal eenheden in verpakking 2	150
verpakking 2 hoogte	30,000 cm

verpakking 2 breedte	30,000 cm
verpakking 2 lengte	40,000 cm
verpakking 2 gewicht	12,208 kg
Eenheidstype van verpakking 3	P06
Aantal eenheden in verpakking 3	1200
verpakking_3_hoogte	75,000 cm
verpakking 3 breedte	60,000 cm
verpakking 3 lengte	80,000 cm
verpakking 3 gewicht	109,180 kg

## contractuele waarborg

Garantie (in maanden)	18
-----------------------	----

Schneider Electric wil tegen 2050 de Net Zero-status hebben bereikt via partnerschappen in de toeleveringsketen, materialen met een lagere impact en circulariteit via onze doorlopende campagne "Use Better, Use Longer, Use Again" om de levensduur van producten en de recycleerbaarheid te verlengen.

[Uitleg van Environmental Data >](#)

[Hoe evalueren we de duurzaamheid van producten? >](#)

### Milieuoetafdruk

Totale levenscyclus ecologische voetafdruk	2 kg CO2 eq.
Koolstofvoetafdruk van de fabricagefase [A1–A3]	0.6 kg CO2 eq.
Koolstofvoetafdruk van de distributiefase [A4]	0 kg CO2 eq.
Koolstofvoetafdruk van de installatiefase [A5]	0 kg CO2 eq.
Koolstofvoetafdruk van de gebruiksfase [B2, B3, B4, B6]	1 kg CO2 eq.
Koolstofvoetafdruk van de einde-levensfase [C1–C4]	0.2 kg CO2 eq.

## Use Better

### Materialen en verpakking

Gemiddeld percentage gerecycleerde kunststof	36 %
Gemiddeld percentage gerecycleerd metaal	17 %
Pakket met gerecycleerd karton	Ja
Verpakkingen zonder kunststof	Ja
SCIP-nummer	3d14fd98-3859-4733-a5ee-a3016769973c
RoHS-richtlijn van de EU	<a href="#">Conform door vrijstelling</a>
REACH-verordening	<a href="#">Referentie bevat zorgwekkende stoffen (SVHC) boven drempelwaarde</a>

## Use Longer

### Levensduurverlenging

Reparatie	Nee
Productreparatie-index	<a href="#">A</a>

## Use Again

### Herverpakken en herfabriceren

Circulair Profiel	<a href="#">Informatie over einde levensduur</a>
Terugname	Ja
WEEE-label	 Het product moet op markten van de Europese Unie worden afgevoerd volgens specifieke afvalinzamelingsregels en mag nooit in een gewone vuilnisbak terecht komen.

## Dimensions Drawings

## Dimensions

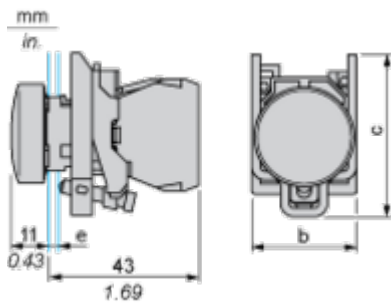

**e** : clamping thickness: 1 to 6 mm / 0.04 to 0.24 in.

**b** : 30 mm / 1.18 in.

**c** : 46.5 mm / 1.83 in.

Mounting and Clearance

Panel Cut-out for Pushbuttons, Switches and Pilot Lights (Finished Holes, Ready for Installation)

Connection by Screw Clamp Terminals or Plug-in Connectors or on Printed Circuit Board	Connection by Faston Connectors
	
<p>(1) Diameter on finished panel or support                  (2) 40 mm min. / 1.57 in. min.                  (3) 30 mm min. / 1.18 in. min.                  (4) <math>\varnothing 22.5 \text{ mm} / 0.89 \text{ in. recommended } (\varnothing 22.3 \text{ mm }_0^{+0.4} / 0.88 \text{ in. }_0^{+0.016})</math>                  (5) 45 mm min. / 1.78 in. min.                  (6) 32 mm min. / 1.26 in. min.</p>	

Technical Illustration

Dimensions

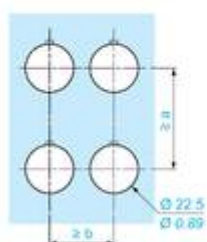
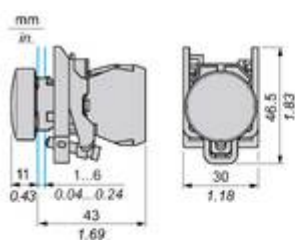

		a (mm)	a (in.)	b (mm)	b (in.)
		40	1.57	30	1.18
ZBE.....	ZBV.....				
		45	1.77	32	1.26
ZBE.....3	ZBV.....3				
		40	1.57	30	1.18
ZBE.....4	ZBV.....4				
		50	1.97	30	1.18
ZBE.....5	ZBV.....5				
		40	1.57	30	1.18
ZBE.....9	ZBV.....9				
ZBRT•	ZBRV1	40	1.57	30	1.18

Offer Marketing Illustration









Product benefits / Features

---

The graphic features a green background with the title "Features" and subtitle "Harmony XB4/XB5 Illuminated functions". It contains four feature descriptions, each with an icon and a product image: 1. "NEW universal LED Block for all colors" with a square icon and a green button image. 2. "Simple stock management" with a person icon and a black button image. 3. "Improved installation time and easy selection" with a circular arrow icon and a yellow button image. 4. "Improved color intensity and brightness" with a sun icon and a red button image.

### Features

Harmony XB4/XB5 Illuminated functions

-  NEW universal LED Block for all colors 
-  Simple stock management 
-  Improved installation time and easy selection 
-  Improved color intensity and brightness 

Offer Marketing Illustration



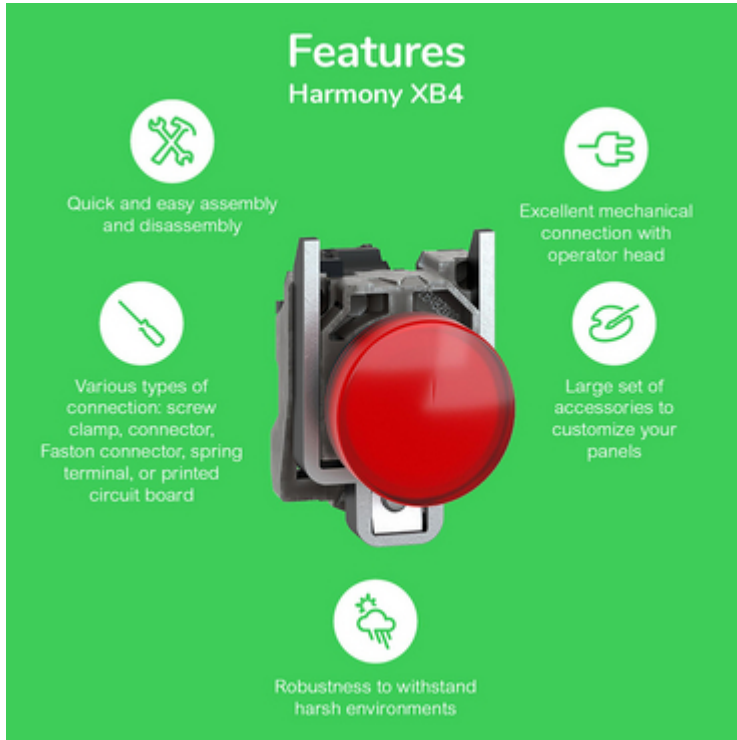

Product benefits / Features

---



The infographic features a central image of a red Schneider XB4 terminal block. Surrounding it are five circular icons, each with a corresponding text description of a feature. The background is a solid green color.

### Features Harmony XB4

-  Quick and easy assembly and disassembly
-  Various types of connection: screw clamp, connector, Faston connector, spring terminal, or printed circuit board
-  Excellent mechanical connection with operator head
-  Large set of accessories to customize your panels
-  Robustness to withstand harsh environments

Offer Marketing Illustration

Product benefits / Features

---

## Technical Benefits

### Harmony XB4

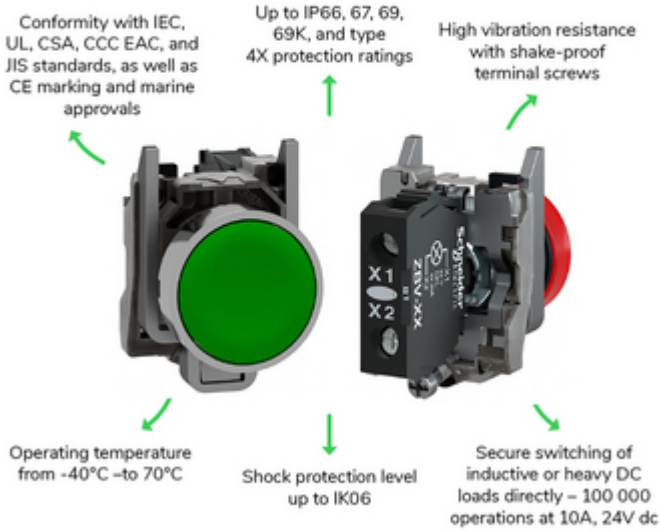

Image of product / Alternate images

Alternative

---





