

Busch-AudioWorld®

8217 U-101

Busch-Radio BTconnect DAB+



1	Notes on the instruction manual	5
2	Trademarks.....	5
3	Safety.....	6
3.1	Introduction.....	6
3.2	Information and symbols used.....	6
3.3	Intended use	7
3.4	Improper use	7
3.5	Target group / Qualifications of personnel.....	8
3.5.1	Operation	8
3.5.2	Installation, commissioning and maintenance	8
3.6	Safety instructions.....	9
3.7	Cyber security	9
3.7.1	Stored data.....	9
3.7.2	Recommended behaviour	9
4	Information on protection of the environment	10
4.1	Environment	10
5	Setup and function.....	11
5.1	Functions.....	11
5.2	Possible combinations	12
6	Technical data	13
7	Connection, installation / mounting	14
7.1	Safety	14
7.2	Requirements for the electrician	14
7.3	Mounting / dismantling	15
7.4	Electrical connection	20
7.5	Multimedia connection	21
7.5.1	Loudspeaker	21
7.5.2	AUX (Auxiliary).....	23
7.5.3	Antenna.....	25
8	Commissioning	26
9	Operation	28
9.1	Operating modes.....	28
9.2	Normal operation.....	30
9.2.1	Overview	30
9.2.2	Button assignment.....	31
9.2.3	Adjusting the volume	32
9.2.4	Selecting the station (Favourites).....	32
9.2.5	Operating alarm clock / snooze function.....	34
9.2.6	Sleep function (turn-off time).....	37
9.2.7	Display favourites (favourite stations).....	38

9.2.8	Save favourites (favourite stations)	38
9.2.9	Operating Bluetooth®	39
9.2.10	Instructions and the rectification of problems for your Bluetooth operation	43
9.2.11	Operating AUX	46
9.2.12	Voltage failure	48
9.3	Operation - Configuration	49
9.3.1	Display	49
9.3.2	Button assignment	50
9.3.3	Functions - Configuration	51
9.3.4	Menu "Alarm clock" - "Alarm clock"	53
9.3.5	Menu "Alarm clock" - "Alarm profiles"	54
9.3.6	Menu "Alarm clock" "Alarm times"	55
9.3.7	Menu "Alarm clock" "Deactivate days"	57
9.3.8	Menu "Alarm clock" – "Specifying "Signal tones"	58
9.3.9	Menu "Station" "Display station list DAB+ " and save favourites	59
9.3.10	Menu "Station" "Display station list FM" and save favourites	60
9.3.11	Menu "Stations" - "Automatic search mode DAB+"	61
9.3.12	Menu "Stations" - "Automatic search mode for FM stations"	62
9.3.13	Menu "Station" – "Setting FM stations manually"	63
9.3.14	Menu "Station" - "Move favourites"	64
9.3.15	Menu "Station" - "Delete favourites"	65
9.3.16	Menu "Bluetooth" - "Mode"	66
9.3.17	Menu "Bluetooth" – "Connect device"	67
9.3.18	Menu "Bluetooth" – "Couple device"	68
9.3.19	Menu "Bluetooth" – "Disconnect active device"	69
9.3.20	Menu "Bluetooth" – "Uncoupling all devices"	70
9.3.21	Menu "Settings" - "Language"	71
9.3.22	Menu "Settings" - "Bass"	74
9.3.23	Menu "Settings" - "Treble"	75
9.3.24	Menu "Settings" - "Start volume"	76
9.3.25	Menu "Settings" - "Maximum volume"	77
9.3.26	Menu "Settings" - "AUX"	78
9.3.27	Menu "Settings" – "AUX input gain"	79
9.3.28	Menu "Settings" - "Display profile"	80
9.3.29	Menu "Settings" - "Display illumination"	81
9.3.30	Menu "Settings" - "Display brightness"	82
9.3.31	Menu "Settings" - "Sleep timer" (switch-off time)	83
9.3.32	Menu "Settings" – "Energy efficiency"	84
9.3.33	Menu "Settings" - "Extension unit operation"	85
9.3.34	Menu "Settings" - "Antenna"	86
9.3.35	Menu "Settings" - "Hotel mode"	87
9.3.36	Menu "Info"	89
9.3.37	RESET (resetting to the factory settings)	91
9.4	Menu tree	92
10	Case studies	95
10.1	Installation set	95
10.2	Installation set and extension unit operation	97
10.3	Installation set and movement detectors	99
10.4	Ceiling loudspeakers	102
10.5	Installation set and Bluetooth loudspeakers	103

10.6	AUX and amplifier	105
10.7	AUX and HiFi system.....	107
10.8	Playing the multimedia device via the flush-mounted radio on the HiFi system.....	109
10.9	AUX and TV audio signals	111
11	Maintenance	113
11.1	Cleaning	113
12	FAQ and tips	114
13	Declaration of conformity.....	116
14	Index	117

1 Notes on the instruction manual

Please read through this manual carefully and observe the information it contains. This will assist you in preventing injuries and damage to property, and ensure both reliable operation and a long service life for the device.

Please keep this manual in a safe place.

If you pass the device on, also pass on this manual along with it.

Busch-Jaeger accepts no liability for any failure to observe the instructions in this manual.

If you require additional information or have questions about the device, please contact Busch-Jaeger or visit our Internet site at:

www.BUSCH-JAEGER.de

2 Trademarks

The Bluetooth® word mark and logos are registered trademarks owned by Bluetooth SIG, Inc. and any use of such marks by [licensee name] is under license. Other trademarks and trade names are those of their respective owners.

3 Safety

3.1 Introduction

The device has been constructed according to the latest valid regulations governing technology and is operationally reliable. It has been tested and left the factory in a technically safe and reliable state.

However, residual hazards remain. Read and adhere to the safety instructions to prevent hazards of this kind.

Busch-Jaeger accepts no liability for any failure to observe the safety instructions.

3.2 Information and symbols used

The following Instructions point to particular hazards involved in the use of the device or provide practical instructions:



Danger

Risk of death / serious damage to health

- The respective warning symbol in connection with the signal word "Danger" indicates an imminently threatening danger which leads to death or serious (irreversible) injuries.



Warning

Serious damage to health

- The respective warning symbol in connection with the signal word "Warning" indicates a threatening danger which can lead to death or serious (irreversible) injuries.



Caution

Damage to health

- The respective warning symbol in connection with the signal word "Caution" indicates a danger which can lead to minor (reversible) injuries.



Attention

Damage to property

- This symbol in connection with the signal word "Attention" indicates a situation which could cause damage to the product itself or to objects in its surroundings.



NOTE

This symbol in connection with the word "Note" indicates useful tips and recommendations for the efficient handling of the product.



This symbol alerts to electric voltage.

3.3 Intended use

This device is a radio for flush-mounted installation.

The device is intended for the following:

- Operation according to the listed technical data,
- Installation in dry interior rooms and suitable flush-mounted boxes,
- Use with the connecting options available on the device.

The intended use also includes adherence to all specifications in this manual.

3.4 Improper use

Each use not listed in Chapter 3.3 “Intended use“ on page 7 is deemed improper use and can lead to personal injury and damage to property.

Busch-Jaeger is not liable for damages caused by use deemed contrary to the intended use of the device. The associated risk is borne exclusively by the user/operator.

The device is not intended for the following:

- Unauthorized structural changes
- Repairs
- Outdoor use
- The use in bathroom areas

3.5 Target group / Qualifications of personnel

3.5.1 Operation

No special qualifications are needed to operate the device.

3.5.2 Installation, commissioning and maintenance

Installation, commissioning and maintenance of the device must only be carried out by trained and properly qualified electrical installers.

The electrical installer must have read and understood the manual and follow the instructions provided.

The electrical installer must adhere to the valid national regulations in his/her country governing the installation, functional test, repair and maintenance of electrical products.

The electrical installer must be familiar with and correctly apply the "five safety rules" (DIN VDE 0105, EN 50110):

1. Disconnect
2. Secure against being re-connected
3. Ensure there is no voltage
4. Connect to earth and short-circuit
5. Cover or barricade adjacent live parts

3.6 Safety instructions



Danger - Electric voltage!

Electric voltage! Risk of death and fire due to electric voltage of 100 ... 240 V. Dangerous currents flow through the body when coming into direct or indirect contact with live components. This can result in electric shock, burns or even death.

- Work on the 100 ... 240 V supply system may only be performed by authorised and qualified electricians.
- Disconnect the mains power supply before installation / disassembly.
- Never use the device with damaged connecting cables.
- Do not open covers firmly bolted to the housing of the device.
- Use the device only in a technically faultless state.
- Do not make changes to or perform repairs on the device, on its components or its accessories.
- Keep the device away from water and wet surroundings.



Caution! - Risk of damaging the device due to external factors!

Moisture and contamination can damage the device.

- Protect the device against humidity, dirt and damage during transport, storage and operation.

3.7 Cyber security

3.7.1 Stored data

No personal data are stored in this device.

Only device data of the coupled Bluetooth devices are stored in the device.

3.7.2 Recommended behaviour

- Unpair all Bluetooth devices before replacing or scrapping the device.
- Reset the device to the factory settings before replacing or scrapping the device.

4 Information on protection of the environment

4.1 Environment



Consider the protection of the environment!

Used electric and electronic devices must not be disposed of with domestic waste.

- The device contains valuable raw materials which can be recycled. Therefore, dispose of the device at the appropriate collecting depot.

All packaging materials and devices bear the markings and test seals for proper disposal. Always dispose of the packaging material and electric devices and their components via the authorized collecting depots and disposal companies.

The products meet the legal requirements, in particular the laws governing electronic and electrical devices and the REACH ordinance.

(EU Directive 2012/19/EU WEEE and 2011/65/EU RoHS)

(EU REACH ordinance and law for the implementation of the ordinance (EC) No.1907/2006).

5 Setup and function

5.1 Functions

The device is a functional radio with various setting options and is installed flush-mounted in the wall. The device offers you the following, for example:

- A Bluetooth interface for music replay from mobile devices and for sending music to mobile devices.
- An AUX interface for music replay from external devices or for sending music to external devices.
- A memory for up to 8 favourites (favourite stations).
- Receiving from DAB+ stations.
- Receiving from FM stations.
- Time and date display.
- An alarm call function.
- A sleep function.

5.2 Possible combinations









		 8217 U-101
	8223 U	X
	8222 EB	X
	8224 EB	X
	8225 EB	X
	8226 EB	X
	8226/10 EB	X
	8252-xxx-101	X

Table 1: Possible combinations



Notice

Connection of loudspeakers, see chapter 7.5.1 “Loudspeaker“ on page 21.

6 Technical data

Designation	Value
Nominal voltage:	230 V AC, $\pm 10\%$, 50 / 60 Hz
Display	
<ul style="list-style-type: none"> ▪ Colour display 	
<ul style="list-style-type: none"> ▪ Visual range horizontal / vertical: 	+/- 80°
Power consumption during the idle state	
<ul style="list-style-type: none"> ▪ ECO mode: 	≤ 0.4 W
<ul style="list-style-type: none"> ▪ Comfort mode: 	≤ 5 W
Output power of loudspeaker:	2 x 2 W (RMS)
Conductor cross section of screw-type terminals, for power supply:	0.2 - 2.5 mm ² , AWG 14 to 26
Skinning length of screw-type terminals, for power supply:	6 mm
Conductor cross-section of push-in terminal, Loudspeaker/signal connection/antenna terminals rigid/flexible:	0.2 - 1.5 mm ² , AWG 16 to 24
Skinning length of loudspeaker/signal connection/antenna terminals:	8 mm
Admissible loudspeaker impedance:	4 to 8 Ω
Frequency range of audio:	250 to 15,000 Hz
Frequency range: of FM:	87.5 to 108 MHz
Frequency range of DAB+:	174 to 240 MHz
Transmission frequency: Bluetooth	2400 to 2483.5 MHz
Maximum transmission power:	≤ 10 dBm
Temperature range:	5 – +40°C
Storage temperature:	-20 – +70°C
Protection type:	IP 20

Table 2: Technical data

7 Connection, installation / mounting

7.1 Safety



Danger - Electric voltage!

Risk of death due to electrical voltage of 100 ... 240 V during short-circuit in the low-voltage conduit.

- Low-voltage and 100 ... 240 V conduits must not be installed together in a flush-mounted box!



Attention! - antenna signal is too weak!

If the antenna signal is too weak at the mounting location planned for the device, it will be difficult or impossible to adjust the radio stations later.

- Before starting work, check whether the antenna signal is strong enough at the location planned for the installation of the device.
- If in doubt, select a different mounting location, or connect an external antenna..

7.2 Requirements for the electrician



Danger - Electric voltage!

Install the device only if you have the necessary electrical engineering knowledge and experience.

- Incorrect installation endangers your life and that of the user of the electrical system.
- Incorrect installation can cause serious damage to property, e.g. due to fire.

The minimum necessary expert knowledge and requirements for the installation are as follows:

- Apply the "five safety rules" (DIN VDE 0105, EN 50110):
 1. Disconnect
 2. Secure against being re-connected
 3. Ensure there is no voltage
 4. Connect to earth and short-circuit
 5. Cover or barricade adjacent live parts.
- Use suitable personal protective clothing.
- Use only suitable tools and measuring devices.
- Check the type of supply network (TN system, IT system, TT system) to secure the following power supply conditions (classic connection to ground, protective earthing, necessary additional measures, etc.).

7.3 Mounting / dismantling



Caution! The device can sustain damage when coming into contact with hard objects!

The plastic parts of the device are sensitive.

- Pull the attachment off only with your hands.
- Do not lever parts off with screwdrivers or similar hard objects.



Hinweis

Elektronische Geräte mit integriertem Schaltnetzteil können im Einzelfall Empfangsstörungen verursachen, wenn diese in unmittelbarer Nähe zum Radio montiert werden.

The flush-mounted insert must only be installed in flush-mounted boxes according to DIN 49073, Part 1, or suitable surface-mounted housings.

Mounting

To install the device, perform the following steps:

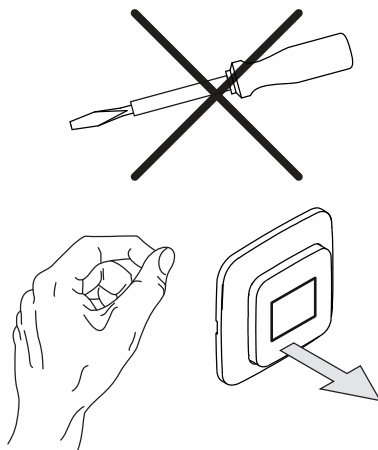

Fig. 1: Wall mounting: pulling off the attachment

1. Pull the attachment off.

- If the device is already mounted or assembled, pull the attachment off the flush-mounted insert with the aid of the cover frame.

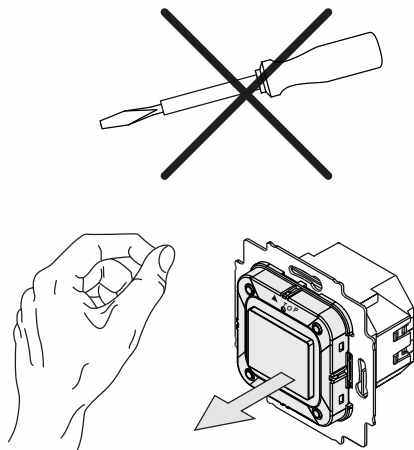

Fig. 2: Device in as-delivered state: pulling off the attachment

- If the device is in its as-delivered state, pull the attachment off the flush-mounted insert with your hands.
- Pull the attachment off only with your hands!
- Do not lever parts off with screwdrivers or similar hard objects. This will damage the device.
- When pulling off, first the resistance of the spring clamps must be overcome.

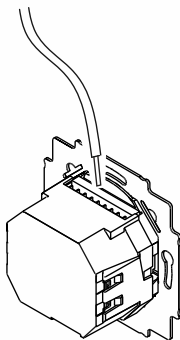

Fig. 3: Connection of loudspeaker cables / signal lines

2. Connect the loudspeaker cables and signal lines to the flush-mounted insert.
 - Both connecting terminals are plug-in terminals.
 - For the connection assignment, see chapter 7.4 “Electrical connection“ on page 20.
 - The following options are available for connecting the plug-in terminals:
 - Loudspeaker (for more detailed information see chapter 7.5.1 “Loudspeaker“ on page 21)
 - AUX input / AUX output (for more detailed information see chapter 7.5.2 “AUX (Auxiliary)“ on page 23)
 - Antenna (for more detailed information see chapter 7.5.3 “Antenna“ on page 25)

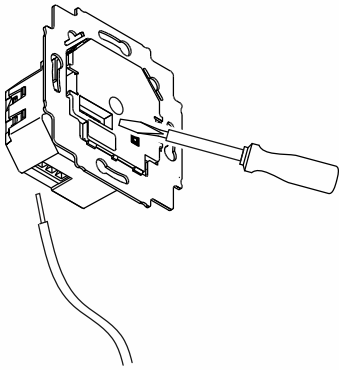

Fig. 4: Connecting the power supply cable

3. Connect the mains cables to the flush-mounted insert.
 - Both connecting terminals are screw-type terminals.
 - Screw-type terminals (max. 3.5 Lb-In, 0.4 Nm)
 - For the connection assignment, see chapter 7.4 “Electrical connection“ on page 20.

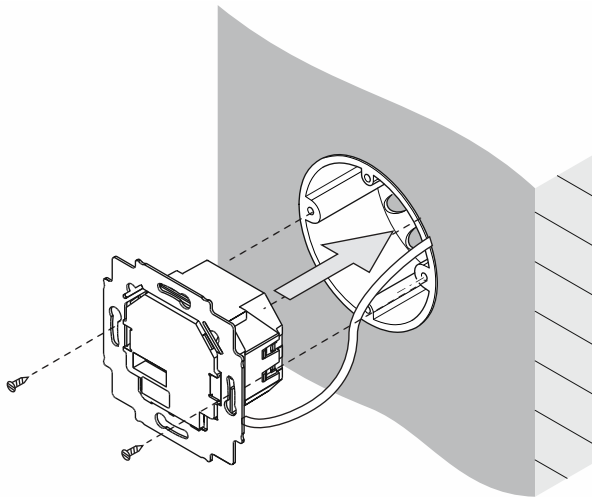

Fig. 5: Mounting the flush-mounted insert

4. Mount the flush-mounted insert.

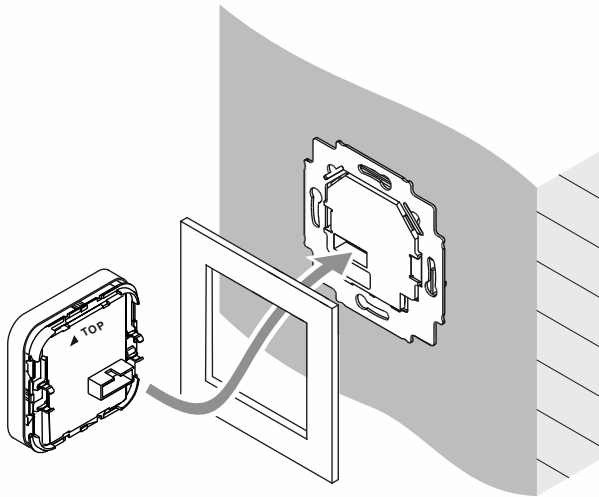

Fig. 6: *Mounting the display*

5. Plug the attachment together with the cover frame onto the flush-mounted insert.
 - Ensure that the plug-in connection on the rear side does not get jammed.
 - The arrow (TOP) must point upwards when plugging it.
 - If mounting is difficult, check whether a burr has formed at the lock-in openings of the flush-mounted insert and remove it.

The device is now mounted.

Dismantling

To dismantle the device, perform the following steps:

Dismantling is carried out in the reverse order to mounting.

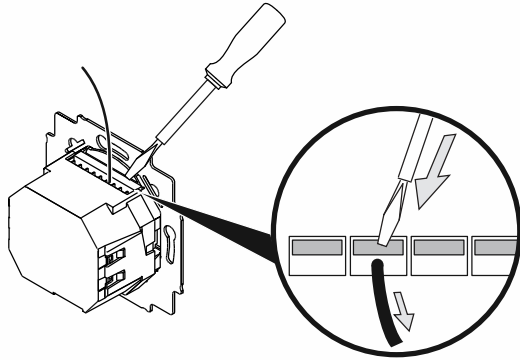

Fig. 7: Loosening the plug-in terminals

- Loosen the plug-in terminals of the loudspeaker cables and signal lines on the flush-mounted insert with the aid of a screwdriver.
 - Press the terminal fixture into the device and pull the cable out.

7.4 Electrical connection



Note

- An automatic circuit breaker must be available in the building installation.
- Automatic circuit breaker: 110 - 230 V AC, $\pm 10\%$, 50 / 60 Hz max. B16A.
- Local regulations for electrical installations must be adhered to.

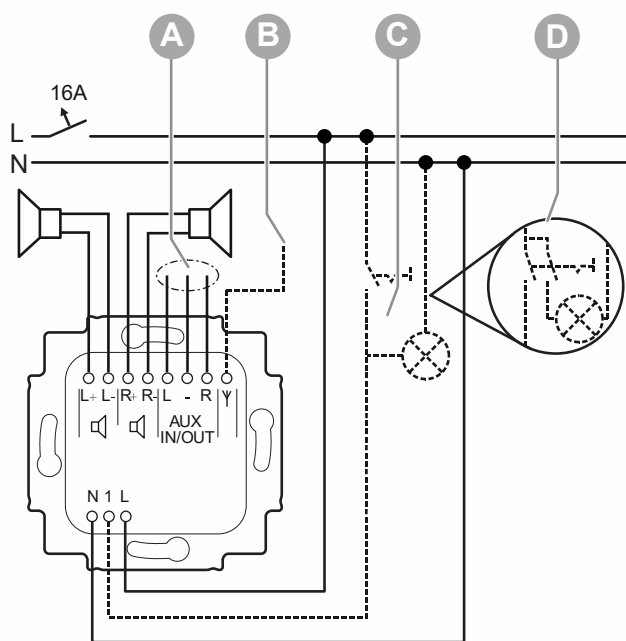

Fig. 8: Electrical connection

- [A] Option: AUX terminals configured as input or output, see chapter 9.3.26 "Menu "Settings" - "AUX"" on page 78.
- [B] Option: connection of an external antenna, see chapter 7.5.3 "Antenna" on page 25.
- [C] Option: simultaneous switch-on with room light.
- [D] Variation: When connecting fluorescent lamps, energy-saving lamps or LED lamps, a 2-pole switch is recommended.

7.5 Multimedia connection

7.5.1 Loudspeaker

MONO operation

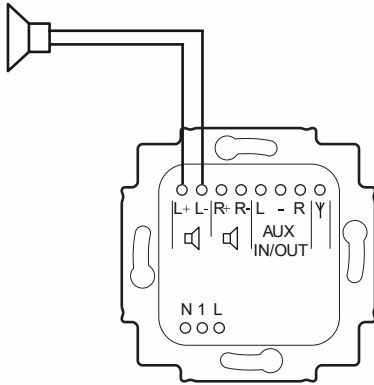

Fig. 9: Loudspeaker connection MONO

For MONO operation, the loudspeaker can be connected to the left (L+ / L-) or right (R+ / R-) connecting terminals.

- Observe the polarity of the connections when connecting the loudspeakers.

STEREO operation

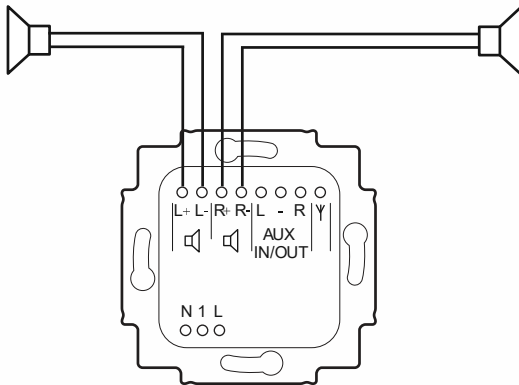

Fig. 10: Loudspeaker connection STEREO

For STEREO operation, two loudspeakers can be connected, one to the left (L+ / L-) and one to the right (R+ / R-) connecting terminal.

- Observe the polarity of the connections when connecting the loudspeakers.

Bluetooth®

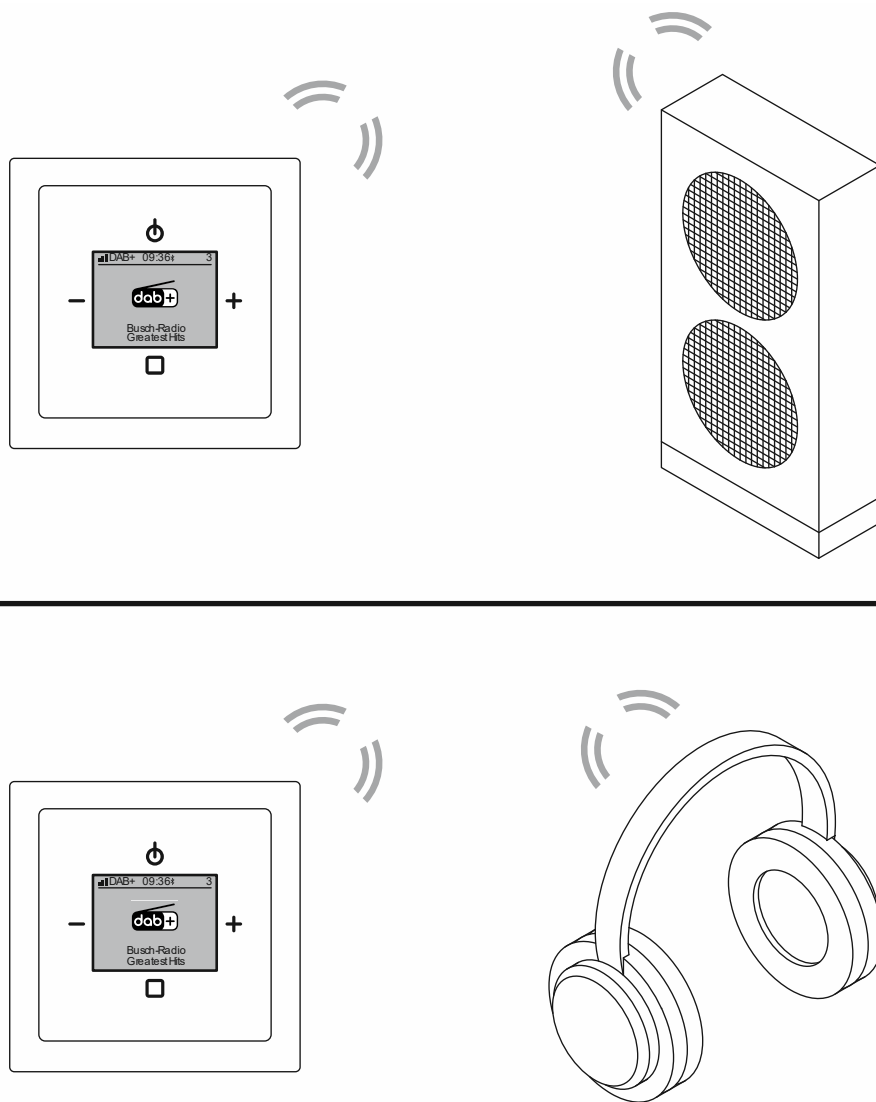

Fig. 11: Loudspeaker connection via Bluetooth®

More detailed information for the connection of a Bluetooth loudspeaker, see chapter 9.2.9 “Operating Bluetooth® “ on page 39.

If a Bluetooth loudspeaker is connected with the device, the internal loudspeakers of the device are deactivated.

Further options for the use of the Bluetooth function of the device is available in the examples of the application, see chapter 10 “Case studies“ on page 95.

7.5.2 AUX (Auxiliary)

The AUX inputs or AUX outputs are analogue inputs / outputs for audio signals.

External audio sources can be connected to AUX inputs. E.g. MP3-Players or the audio channel of a TV. These audio signals are then output via the loudspeakers connected to the device.

For the transmission of the audio signals, amplifiers of a stereo system can be connected. The audio signals of the device are then output via the HiFi system.

- For the switchover in the device between AUX input and AUX output, see chapter 9.3.26 "Menu "Settings" - "AUX"" on page 78.
- For the operation of the AUX function, see chapter 9.2.11 "Operating AUX" on page 46.
- For different examples of the application of the device, see chapter 10 "Case studies" on page 95.

The AUX connection of external devices can be made, for example, via the following options:

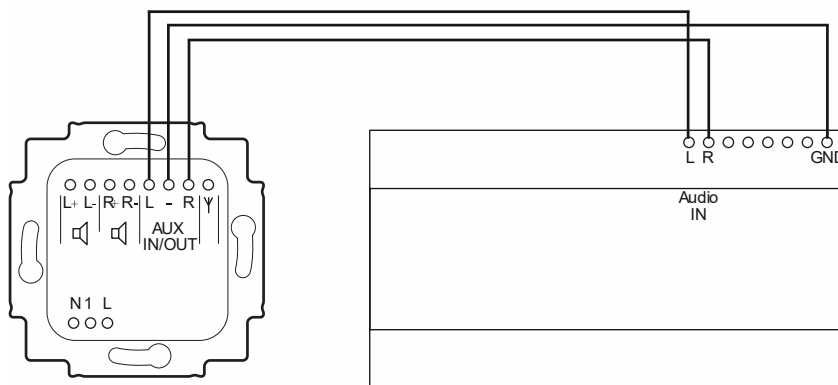

Fig. 12: AUX connection of an amplifier

- Connection directly on the device. The example shows an amplifier connected for fitting to a mounting rail.

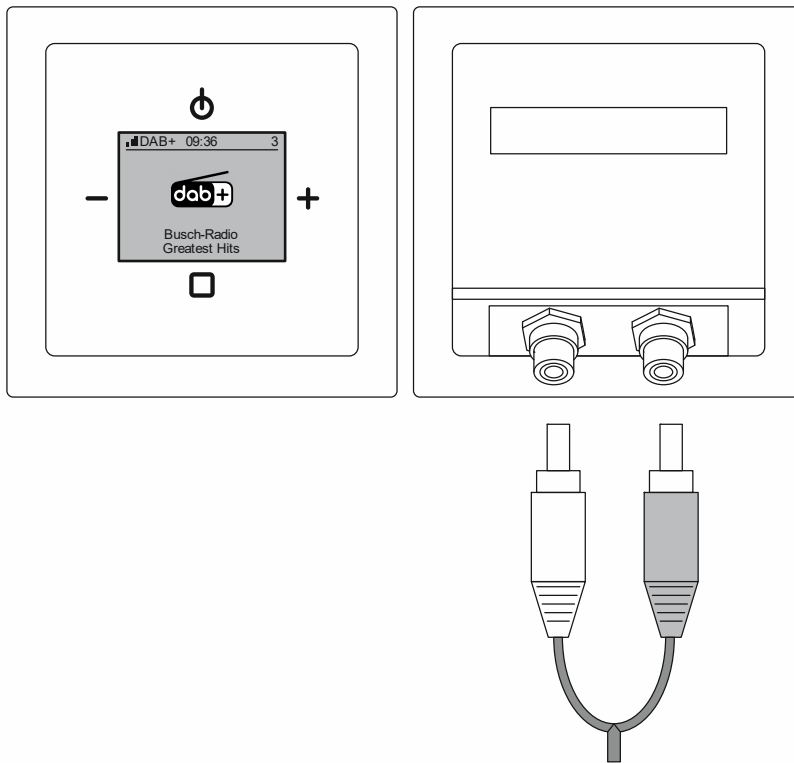

Fig. 13: AUX extension Cinch

- Connection via communication adapter with cinch-jacks.



Notice

Communication adapters must be assembled separately depending on the model. The necessary products are selected in the online catalogue.

7.5.3 Antenna

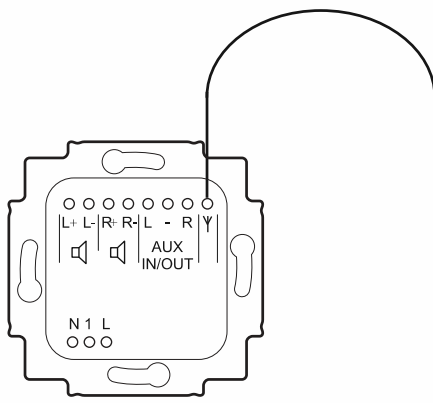

Fig. 14: Antenna

An external antenna can be connected directly on the device. E.g. a cable antenna.

- Cable antenna: Length approx. 90 cm, wire cross-section 0.5 mm² (AWG 18 – 22).

Changes to the position of the cable antenna can have a serious effect on the quality of reception. The best position can only be determined by means of testing.

8 Commissioning

For this device there is no classic technical commissioning. After activating the electric power, selected areas are run through consecutively from the "Settings" area.

- This setup is carried out automatically during initial commissioning or after resetting the settings (see chapter 9.3.37 "RESET (resetting to the factory settings)" on page 91).
- In the functions of area "Settings" the device switches automatically to the next function after a function has been confirmed. If certain functions are not relevant for you, you can change to the next function by pressing the "PLUS" or "MINUS" button.
- A detailed description of the individual steps is contained in the following sub-sections of the "Settings" area.

Carry out the setup in the following order:

No.	Menu item		
1.	Language (only during initial commissioning)		see chapter 9.3.21 "Menu "Settings" - "Language"" on page 71
2.	AUX Input / AUX Output		see chapter 9.3.26 "Menu "Settings" - "AUX"" on page 78
3.	Start search mode	<p>Search for station and save automatically as favourite.</p> <ul style="list-style-type: none"> ▪ The frequency range DAB+ and FM is searched for stations. ▪ During the search a progress bar is displayed. ▪ Of the stations found, a total of 4 are stored as favourites in alphabetic order. <ul style="list-style-type: none"> – The first 4 DAB+ radio stations are saved as favourites. – If less than 4 DAB+ stations are found, they are filled with FM stations. 	<p>Additional favourites can be added later via a station scan mode. Eight positions are available for favourites.</p> <ul style="list-style-type: none"> ▪ see chapter 9.3.11 "Menu "Stations" - "Automatic search mode DAB+"" on page 61 ▪ see chapter 9.3.12 "Menu "Stations" - "Automatic search mode for FM stations"" on page 62 ▪ see chapter 9.3.13 "Menu "Station" – "Setting FM stations manually"" on page 63

Table 3: Setup

After the automatic search, the device switches back to standard operation automatically and plays the first stored favourite.

- If no stations are found during the automatic search, the device changes automatically into favourite "Bluetooth". In this case the Bluetooth icon on the display flashes.
- In this case the quality of reception via the antenna will probably be insufficient. For possible reasons and measures, See "Bad quality of reception" on page 114.
- Additional favourites can be added separately after commissioning.
 - see chapter 9.3.11 "Menu "Stations" - "Automatic search mode DAB+"" on page 61
 - see chapter 9.3.12 "Menu "Stations" - "Automatic search mode for FM stations"" on page 62
 - see chapter 9.3.13 "Menu "Station" – "Setting FM stations manually"" on page 63

9 Operation

9.1 Operating modes

The device has three operating modes.

Standby

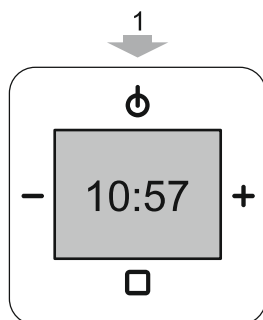

Fig. 15: Standby

- The device is in standby.
 - Via the "ON / OFF" button [1] you switch the device into "Standard" operation or back into "Standby" operation.

Standard operation

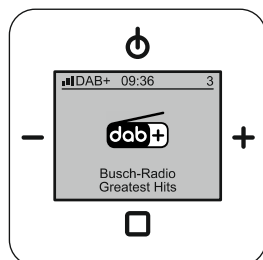

Fig. 16: Standard operation

- E.g. for playing music
 - see chapter 9.2 "Normal operation" on page 30.

Configuration

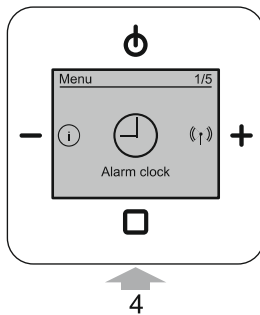

Fig. 17: Configuration / Setup

- E.G Setting the alarm time
 - see chapter 9.3 “Operation - Configuration“ on page 49.
 - With a long press (> approx. 2 seconds) of the "ENTER" button [4], you switch the device into "Configuration" operation.
 - The keyboard occupation changes into the "Configuration" area.

9.2 Normal operation

9.2.1 Overview

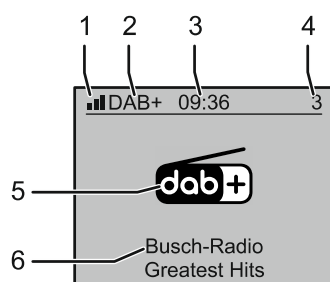

Fig. 18: Overview of radio display

- [1] Current reception quality of the selected station
- [2] Signal type of the reception signal
 - Analogue (FM)
 - Digital (DAB+)
- [3] Time / Status display
- [4] Favourite position of the stored radio station
- [5] Current radio station
- [6] Information about the current radio station

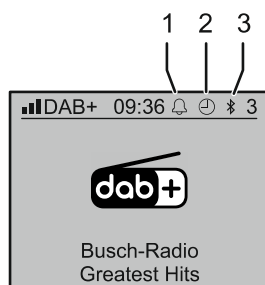

Fig. 19: Overview of display icons

- [1] The alarm is activated
- [2] Turn-off time (sleep function) is set
- [3] The Bluetooth function sends



Notice

The display settings deviate when a different profile is selected.

9.2.2 Button assignment

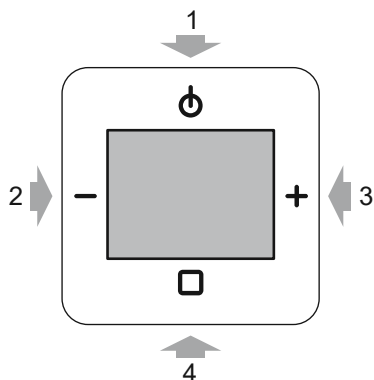

Fig. 20: Button assignment for operation

[1] ON/OFF

- Switch the device into standby operation or into standard operation.
- Sleep function (press the button for at least 2 seconds), see chapter 9.2.6 “Sleep function (turn-off time)” on page 37.

[2] Minus

- Lower volume
 - At a longer press of the button the volume changes automatically up to the release of the button.

[3] Plus

- Higher volume
 - At a longer press of the button the volume changes automatically up to the release of the button.

[4] Enter

- Change between favourite stations
- Change into the configuration menu (press the button for at least 2 seconds)

9.2.3 Adjusting the volume

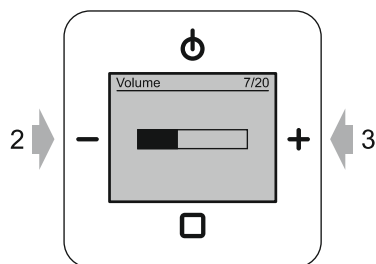

Fig. 21: Adjusting the volume

Use the following steps to adjust the volume:

1. During normal operation press the buttons "MINUS" [2] or "PLUS" [3].
 - The device adjusts the volume.
 - In Bluetooth mode the volume cannot be adjusted fully down. You would not hear anything from your connected multimedia device if you wish to adjust the volume from there.

9.2.4 Selecting the station (Favourites)

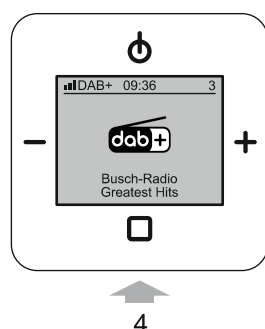

Fig. 22: Changing stations (Favourites)

Eight positions are available in the device for favourites. When the device is switched on, the favourite that was last listened to is displayed and is played.

Use the following steps to change between favourites:

1. Activate the "ENTER" button [4].
 - The device changes to the next favourite.
 - When changing to an FM station, the station's frequency is displayed. Depending on the station, also the name of the station is displayed (RDS).

The favourite has been changed.

Via the station search mode the stations can be preset and stored as favourites in 8 positions.

- Station search mode:
 - see chapter 9.3.11 “Menu “Stations” - “Automatic search mode DAB+”” on page 61
 - see chapter 9.3.12 “Menu “Stations” - “Automatic search mode for FM stations”” on page 62
 - see chapter 9.3.13 “Menu “Station” – “Setting FM stations manually”” on page 63

The DAB+ and FM stations can be mixed in the favourites. If there is a change between a DAB+ and an FM favourite, this can take some time since the device must switch over internal between digital and analogue.

**Notice**

- If no favourites are stored in the device, the device changes into favourite "Bluetooth" directly after activation. The Bluetooth icon on the display flashes. For additional information about the Bluetooth icon, see chapter 9.2.9 “Operating Bluetooth® “ on page 39.
- The favourite "Bluetooth" is located behind the last saved favourite. If all 8 favourites are occupied, it is located at position 9. For additional information on Bluetooth operation, see chapter 9.2.9 “Operating Bluetooth® “ on page 39.

9.2.5 Operating alarm clock / snooze function

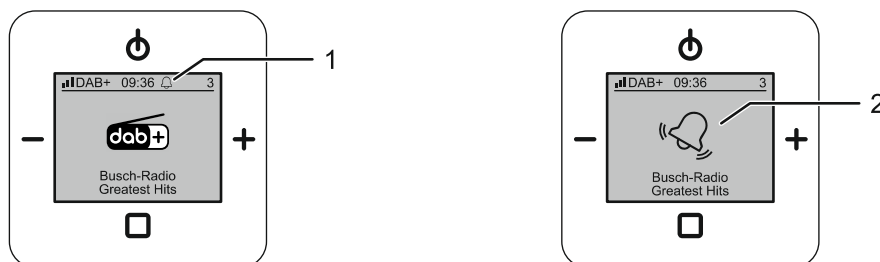

Fig. 23: Alarm call function

A beep is available for the alarm or playing of the radio.

The active alarm call function is shown in the display [1].

The alarm signal is shown in the display when the alarm clock starts [2]. The beep or the radio gets gradually louder.

The alarm can be interrupted for 5 minutes by pressing any button (snooze function).

The alarm times, alarm profiles, etc. are set in the configuration menu of the device.

- Alarm profiles, see chapter 9.3.5 “Menu "Alarm clock" - "Alarm profiles"” on page 54.
- Alarm times, see chapter 9.3.6 “Menu "Alarm clock" "Alarm times"” on page 55.
- Signal tones, see chapter 9.3.8 “Menu "Alarm clock" – "Specifying "Signal tones"” on page 58.

Switching the alarm clock on and off is carried out in the configuration menu of the device, see chapter 9.3.4 “Menu "Alarm clock" - "Alarm clock"” on page 53.

The maximum volume of the signal tone can be reduced, see chapter 9.3.25 “Menu "Settings - "Maximum volume"” on page 77.



Notice

The alarm times must be entered before the alarm clock is turned on for the first time.

- Only then can the alarm clock be switched on.
- Only then can the alarm days be deactivated.

Switching the alarm clock on or off

The alarm clock is switched on or off in the configuration menu of the device, see chapter 9.3.4 “Menu "Alarm clock" - "Alarm clock"” on page 53.

- This prevents the alarm function from being inadvertently switched off via the button during standard operation.

Interrupting the alarm clock (snooze function)

Start the snooze function by pressing any button of the device.

- The snooze function can only be started during the signal tone.

Behaviour of the alarm call function and the snooze function

The behaviour of the alarm call and snooze function depends on the switching state of the device. Four possible switching states are listed in the following.

Case A	<ul style="list-style-type: none"> ▪ The radio is switched on and is playing. ▪ "Beep" has been set as signal tone. ▪ The alarm time has been reached.
Behaviour and functions:	
<ul style="list-style-type: none"> ▪ When the alarm time is reached, the radio is interrupted and the signal tone is output (alarm mode). <ul style="list-style-type: none"> – The volume of the signal tone changes according to the ramp function. <ul style="list-style-type: none"> – The volume increases from 20% to 100% of the maximum volume. – The signal tone lasts for 20 seconds at 20%. Then it increases every second for approximately 25 seconds until the maximum volume is reached. ▪ Display output in alarm mode: <ul style="list-style-type: none"> – "Alarm" ▪ The alarm mode ends automatically after 1 minute. ▪ The signal tone can be stopped with any button (snooze function). <ul style="list-style-type: none"> – This switches the device back into the play mode and the radio plays again. – After 5 minutes the device switches automatically back into the alarm mode. – This process is repeated 3 times. – There are three ways to stop the repeats early (to deactivate the alarm function): <ul style="list-style-type: none"> – Press the "OFF" button long (approx. 2 seconds) during the signal tone. – Press the "OFF" button during the time between the two signal tones. This also switches the radio off, since it is in playing mode between the signal tones. – Deactivate the alarm clock in the configuration menu of the device, see chapter 9.3.4 "Menu "Alarm clock" - "Alarm clock"" on page 53. The alarm call function is then fully deactivated. If the alarm clock is to operate again the next day, it must be switched on again. 	

Table 4: Alarm clock / Snooze function Case A

Case B	<ul style="list-style-type: none"> ▪ The radio is switched on and is playing. ▪ "Radio" has been set as signal tone. ▪ The alarm time has been reached.
Behaviour and functions:	
<ul style="list-style-type: none"> ▪ The behaviour and functions are the same as in Case A. <ul style="list-style-type: none"> – When the alarm time is reached, the radio is interrupted and the beep is output as signal tone. 	

Table 5: Alarm clock / Snooze function Case B

Case C	<ul style="list-style-type: none"> ▪ The radio is switched off. ▪ "Beep" has been set as signal tone. ▪ The alarm time has been reached.
Behaviour and functions:	
<ul style="list-style-type: none"> ▪ The behaviour and functions are the same as in Case A. <ul style="list-style-type: none"> – The radio is off between the signal tones. 	

Table 6: Alarm clock / Snooze function Case C

Case D	<ul style="list-style-type: none"> ▪ The radio is switched off. ▪ "Radio" has been set as signal tone. ▪ The alarm time has been reached.
Behaviour and functions:	
<ul style="list-style-type: none"> ▪ The radio switches to the program position used last. <ul style="list-style-type: none"> – If the AUX program position or the Bluetooth program position has been used, program position 1 or the first occupied program position is used. ▪ The volume corresponds to the volume value used last. ▪ The play duration of the radio is limited to one hour. <ul style="list-style-type: none"> – If the device is switched off and on again in the meantime, the limitation is cancelled. 	

Table 7: Alarm clock / Snooze function Case D

9.2.6 Sleep function (turn-off time)

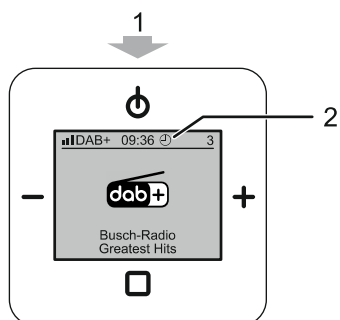

Fig. 24: Sleep timer operation

By switching on the sleep function the device is automatically switched off after a preset time.

This function can only be called up when the radio is switched on.

The switching time of the switching function is adjusted in the settings, see chapter 9.3.31 "Menu "Settings" - "Sleep timer" (switch-off time)" on page 83.

Use the following steps to activate or deactivate the sleep function:

Activating the sleep function

1. Press the "ON / OFF" button [1] for at least 2 seconds while the radio is switched on.
 - The sleep function is switched on.
 - The "Stopwatch" icon [2] appears in the display.
 - The radio switches itself off automatically after the preset time.
 - For setting switching time, see chapter 9.3.31 "Menu "Settings" - "Sleep timer" (switch-off time)" on page 83.

Deactivating the sleep function

Way 1

1. Switch the radio off and on again.
 - The sleep function is deactivated.
 - The "Stopwatch" icon goes out on the display.

Way 2

1. Press the "ON / OFF" button [1] for at least 2 seconds while the sleep function is active.
 - The sleep function is deactivated.
 - The "Stopwatch" icon [2] goes out on the display.

9.2.7 Display favourites (favourite stations)

There are two ways to display favourites. Change to the following functions in the device:

- Move favourites, see chapter 9.3.14 “Menu "Station" - "Move favourites”” on page 64.
- Delete favourites, see chapter 9.3.15 “Menu "Station" - "Delete favourites”” on page 65.

Here each list of all stored favourites is displayed:

9.2.8 Save favourites (favourite stations)

The favourites are saved from the DAB+ or the FM station list. Here each list with all located DAB+ or FM stations is displayed:

- Saving of DAB+ stations as favourite, see chapter 9.3.9 “Menu "Station" "Display station list DAB+ " and save favourites“ on page 59.
- Saving of FM stations as favourite, see chapter 9.3.10 “Menu "Station" "Display station list FM" and save favourites“ on page 60.

If required, a station list can be updated beforehand. For this a station search mode must be carried out.

- Searching for DAB+ station automatically, see chapter 9.3.11 “Menu "Stations" - "Automatic search mode DAB+”” on page 61.
- Searching for DAB+ station automatically, see chapter 9.3.12 “Menu "Stations" - "Automatic search mode for FM stations”” on page 62.
- Searching for FM station manually, see chapter 9.3.13 “Menu "Station" – "Setting FM stations manually”” on page 63.

9.2.9 Operating Bluetooth®

Bluetooth® allows data transmission between devices over short distances.

Your device uses this technology to receive and play or send digital music data. E.g. via smartphones or Bluetooth loudspeakers.

- Examples of device compilations for the use of Bluetooth®, see chapter 10 “Case studies” on page 95



Notice

The flush-mounted radio is compatible with the popular Bluetooth-capable devices that support the Bluetooth profile A2DP for audio transmission. However, due to the technical design of external Bluetooth devices it may happen that a Bluetooth device is not compatible with the flush-mounted radio.

Hearing Bluetooth® on the flush-mounted radio (music-stream)

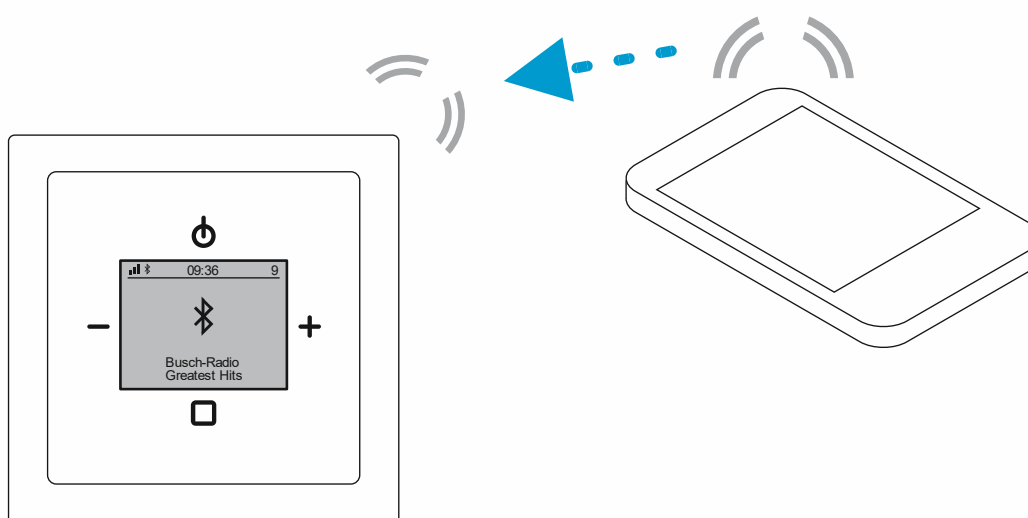

Fig. 25: Receiving Bluetooth®

To play the data of an external multimedia device on the flush-mounted radio, the following settings must have been made:

- The Bluetooth mode of the flush-mounted radio must be set on "Receiver".
 - Setting Bluetooth mode, see chapter 9.3.16 “Menu "Bluetooth" - "Mode"” on page 66.
- The external multimedia device must be coupled with the flush-mounted radio.
 - Coupling devices, see chapter 9.3.18 “Menu "Bluetooth" – "Couple device"” on page 68.
 - Connecting devices, see chapter 9.3.17 “Menu "Bluetooth" – "Connect device"” on page 67.

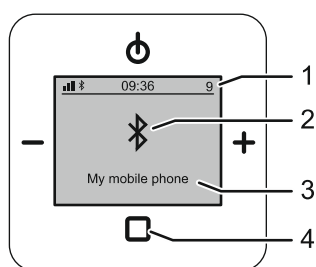

Fig. 26: Bluetooth®

Use the following steps to play data on the flush-mounted radio:

1. Switch the flush-mounted radio on.
 - After the device is switched on, the favourite that was last listened to is displayed.
2. Press button "ENTER" [4] as often as required until you have changed to the Bluetooth favourite.
 - The current favourite number [1] is shown at the top right-hand in the display.
 - After the change to the "Bluetooth" favourite, the Bluetooth function is active. The Bluetooth icon [2] is displayed permanently. The device connected with the flush-mounted device is displayed below the Bluetooth icon [3].
 - If the Bluetooth icon [2] flashes after the change to the "Bluetooth" favourite, no external device is connected with the flush-mounted radio. The "Bluetooth" favourite is in standby. The "Bluetooth" favourite is visible in the transmission range for other devices and can be connected with the radio.
 - In this case an outgoing connection / coupling from the external multimedia device must be established.
 - A coupling with the external multimedia device to the "Flush-mounted radio" must be established. Check with the manufacturer of the multimedia device how this connection is established.

Hearing the station of the flush-mounted radio on the external multimedia device

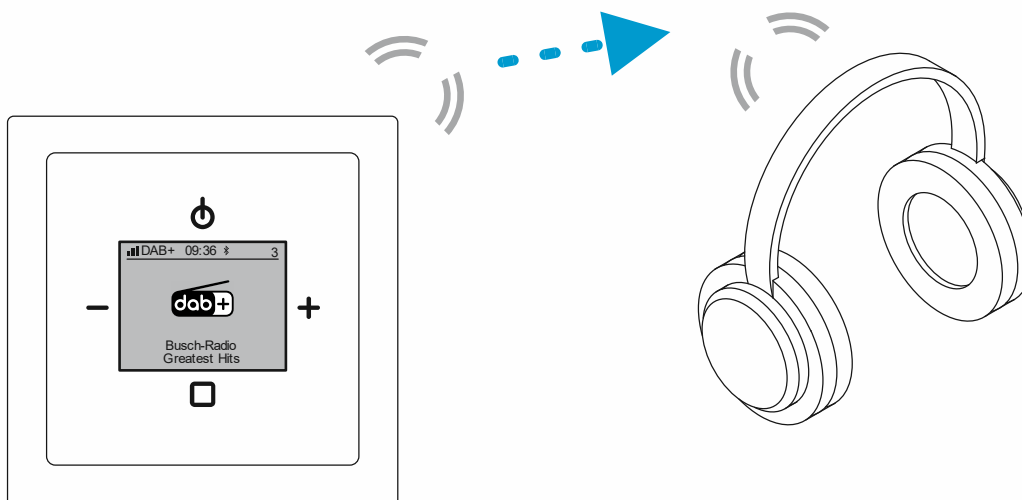

Fig. 27: Send Bluetooth®

To play a favourite of the flush-mounted radio on an external multimedia device, the following settings must have been made:

- The Bluetooth mode of the flush-mounted radio must be set on "Station".
 - Setting Bluetooth mode, see chapter 9.3.16 "Menu "Bluetooth" - "Mode"" on page 66.
- The external multimedia device must be coupled with the flush-mounted radio.
 - Coupling devices, see chapter 9.3.18 "Menu "Bluetooth" – "Couple device"" on page 68.
 - Connecting devices, see chapter 9.3.17 "Menu "Bluetooth" – "Connect device"" on page 67.



Fig. 28: Multimedia device

To play a favourite of the flush-mounted radio on an external multimedia device, perform the following steps:

1. Switch the flush-mounted radio on.
 - After the device is switched on, the favourite that was last listened to is displayed.
2. Select the desired favourite on the flush-mounted radio.
3. Establish the connection to the external multimedia device.

- Depending on the external multimedia device, the connection is established automatically. If this is not the case, establish the connection from the flush-mounted radio, see chapter 9.3.17 “Menu “Bluetooth” – “Connect device”” on page 67.
- 4. Play the favourite of the flush-mounted radio on the multimedia device.
 - During playing of DAB+ stations the slide show is not displayed on the flush-mounted radio.

Bluetooth functions on the flush-mounted radio

- Setting Bluetooth mode
 - see chapter 9.3.16 “Menu “Bluetooth” - “Mode”” on page 66
- Coupling devices
 - see chapter 9.3.18 “Menu “Bluetooth” – “Couple device”” on page 68
- Uncoupling devices
 - see chapter 9.3.20 “Menu “Bluetooth” – “Uncoupling all devices”” on page 70
- Connecting devices
 - see chapter 9.3.17 “Menu “Bluetooth” – “Connect device”” on page 67
- Disconnecting devices
 - see chapter 9.3.19 “Menu “Bluetooth” – “Disconnect active device”” on page 69

9.2.10 Instructions and the rectification of problems for your Bluetooth operation

Functions / Preliminary considerations

- Coupling
 - The devices are "joined" together. Each one of the other devices is stored in a list.
 - Only coupled devices can be connected with each other to exchange data and to play music.
 - The devices must be uncoupled to delete them from the list.
- Connecting
 - After the connection, the devices exchange the music data for playing.
 - Only coupled devices can be connected with each other.
 - When devices are disconnected, they are not uncoupled automatically.
- Direction of connection:
 - Depending on the direction in which the connection is to be made, first the direction of the connection must be selected in the settings of the flush-mounted radio. This is done by setting the Bluetooth mode on "Receiver" or "Station", see chapter 9.3.16 "Menu "Bluetooth" - "Mode"" on page 66.
 - If the flush-mounted radio is connected with a Bluetooth loudspeaker, the connection is made from the flush-mounted radio since the connection cannot be made from the Bluetooth loudspeaker. In this case the Bluetooth mode of the flush-mounted radio must be set on "Station", see chapter 9.3.16 "Menu "Bluetooth" - "Mode"" on page 66.
 - If the flush-mounted radio is connected with a smartphone, the connection is made from the smartphone.
- Where is the music to be heard.
 - Depending on whether the music is to be heard on the flush-mounted radio or the connected multimedia device, first the Bluetooth mode of the flush-mounted radio must be set on "Station" or on "Receiver", see chapter 9.3.16 "Menu "Bluetooth" - "Mode"" on page 66.
 - If the music is to be played from a Bluetooth loudspeaker, the Bluetooth mode of the flush-mounted radio must be set on "Station" in the settings, see chapter 9.3.16 "Menu "Bluetooth" - "Mode"" on page 66.
 - If the play list is to be played on the flush-mounted radio from a smartphone, the Bluetooth mode of the flush-mounted radio must be set on "Receiver", see chapter 9.3.16 "Menu "Bluetooth" - "Mode"" on page 66.

Bluetooth mode of the flush-mounted radio

The flush-mounted radio only displays the functions that are possible in the respective mode. Impossible functions are not visible.

"Receiver" mode

- Coupling must come from the external device.
- Uncoupling can be made for both devices.
- The connection must come from the external device.
- Disconnection can be made for both devices.
- The "Bluetooth" favourite is displayed on the flush-mounted radio in the favourite stations.
 - If the device is not connected, the Bluetooth icon on the display flashes.
 - If the external device is connected, the name of the external device is displayed and the Bluetooth icon is displayed permanently.

"Station" mode

- Coupling is made from the flush-mounted radio.
 - For most applications (Bluetooth loudspeaker / Bluetooth headphone), the coupling is made from the flush-mounted radio.
- The connection is made from the flush-mounted radio.
 - For most applications (Bluetooth loudspeaker / Bluetooth headphone), the connection is made from the flush-mounted radio.
- The "Bluetooth" favourite is not available on the flush-mounted radio in the favourite stations.

Information about Bluetooth operation

- Depending on the model, the loudspeakers on the multimedia device for playing music have been deactivated while it is connected to the flush-mounted radio.
- After connection, the volume of the flush-mounted is additionally controlled via the volume control of your multimedia device.
 - This depends on the Bluetooth implementation of the respective manufacturer of the multimedia device. The flush-mounted radio supports the Bluetooth A2DP profile to the fullest extent.
 - If you deactivate the volume or turn it down, you will not hear anything on the flush-mounted radio.

Rectification of problems for Bluetooth operation

If the Bluetooth icon is permanently displayed on the flush-mounted radio, the multimedia device is connected.

- Nothing can be heard on the flush-mounted radio.
 - The multimedia device is currently switched off (time out not yet reached).
 - The mute function on the multimedia device has been activated.
 - The volume on the multimedia device has been turned down to "Zero".
 - The player software of the multimedia device in pause mode.
 - This could be the case especially after the connection has been temporarily disrupted.
 - You are at the boundary of the transmission range. While the signal is still strong enough to maintain the connection, it is too weak to transmit sufficient data for playing music.
- The multimedia device cannot be connected, even though the flush-mounted radio is displayed in the Bluetooth settings.
 - A different multimedia device is already connected to the flush-mounted radio.
 - Disconnect and uncouple the connected multimedia device in the flush-mounted radio.
see chapter 9.3.19 "Menu "Bluetooth" – "Disconnect active device"" on page 69
see chapter 9.3.20 "Menu "Bluetooth" – "Uncoupling all devices"" on page 70
You must then couple and connect your multimedia device again because the list of coupled devices stored in the flush-mounted radio has been deleted.

9.2.11 Operating AUX

With the AUX function you play the music of the flush-mounted radio on an external device. E.g. a HiFi system. The music of the external device can also be played on the flush-mounted radio.

- For additional information about the AUX connection, see chapter 7.5.2 "AUX (Auxiliary)" on page 23.
- For examples of device compilations for the use of AUX connection, see chapter 10 "Case studies" on page 95
- Via an input gain the volume of played music can be matched to the other favourites, see chapter 9.3.27 "Menu "Settings" – "AUX input gain"" on page 79.

Hearing music on the flush-mounted radio

To play music of an external device on the flush-mounted radio, the following settings must have been made:

- The "AUX" mode of the flush-mounted radio must be set on "AUX input".
 - For setting AUX mode, see chapter 9.3.26 "Menu "Settings" - "AUX"" on page 78.
 - The favourite "AUX" is only visible when the AUX connection has been set on "AUX input" in the settings.

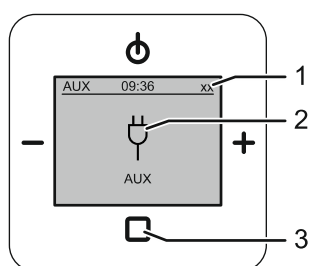

Fig. 29: Hearing music on the flush-mounted radio via AUX

Use the following steps to play music on the flush-mounted radio:

1. Switch the flush-mounted radio on.
 - After the device is switched on, the favourite that was last listened to is displayed.
2. Press button "ENTER" [3] as often as required until you have changed to the "AUX" favourite.
 - The current favourite number [1] is shown at the top right-hand in the display.
 - Favourite "AUX" is the last of the stored favourites.
 - After the change to the "AUX" favourites, the AUX function is active. The AUX icon [2] is displayed.
3. Switch on the external device.
 - The operation of the external device depends on the respective device.
 - The audio channel of the external device is played on the flush-mounted radio.

Hearing the station of the flush-mounted radio on the external device

To play a favourite of the flush-mounted radio on an external device, the following settings must have been made:

- The "AUX" mode of the flush-mounted radio must be set on "AUX output".
 - For setting AUX mode, see chapter 9.3.26 "Menu "Settings" - "AUX"" on page 78.
 - The favourite "AUX" is deactivated in the "AUX output" setting.

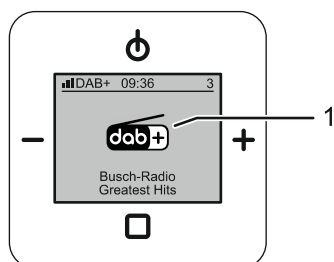

Fig. 30: Hearing music on a different device via AUX

To play a favourite of the flush-mounted radio on an external device, perform the following steps:

1. Switch the flush-mounted radio on.
 - After the device is switched on, the favourite that was last listened to is displayed.
2. Select the desired favourite [1] on the flush-mounted radio.
3. Switch on the external device.
 - The operation of the external device depends on the respective device.
 - The favourite of the flush-mounted radio is played on the external device.

9.2.12 Voltage failure

- At an electric voltage failure all personal settings are retained.
- The time of the device does not update itself automatically after a failure of the electric voltage.
 - After a power failure the on the display shows 00:00.
 - As long as the time shows "00:00", all alarms are inactive.
 - Switch the device OFF and ON again. During the switch-on the time of the device updates itself automatically. All alarms are active again.

9.3 Operation - Configuration

The change to the configuration menu is only possible when the flush-mounted radio is switched on.

To change to the configuration menu, perform the following steps:

1. Switch the flush-mounted radio on.
2. Press the "ENTER" button for at least 2 seconds.
 - The device switches to the configuration menu.

9.3.1 Display

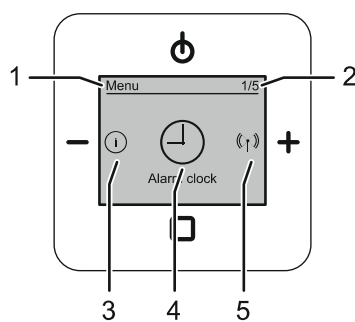

Fig. 31: Display overview of configuration menu

- [1] Menu / menu level
- [2] Menu number
- [3] Previous menu item
- [4] Selected menu item
- [5] Next menu item

9.3.2 Button assignment

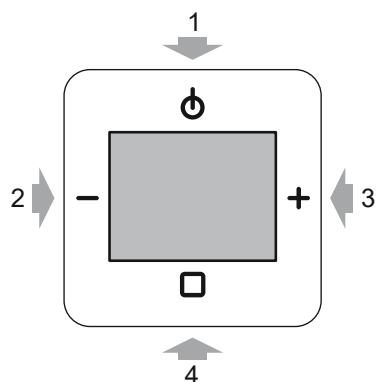

Fig. 32: Key assignment for the configuration menu

- [1] ON/OFF
 - One level higher
- [2] Minus
 - Preceding menu item
- [3] Plus
 - Next menu item
- [4] ENTER
 - Brief press: Call up menu / confirm selection

9.3.3 Functions - Configuration

The manual settings or the start / stop of functions is carried out in the following menus.
Observe also the references to the menu items mentioned in the following.

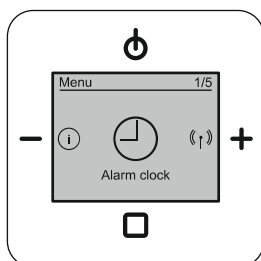

Fig. 33: Alarm clock

Alarm clock (1 / 5), see the chapters regarding the alarm clock from Chapter 9.3.4 "Menu "Alarm clock" - "Alarm clock"" on page 53

- Here the time functions are set, e.g. alarm clock.

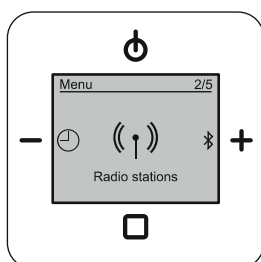

Fig. 34: Radio station

Radio station (2 / 5), see the chapters regarding radio station from Chapter 9.3.9 "Menu "Station" "Display station list DAB+ " and save favourites" on page 59

- Here the radio stations can be searched for, adjusted and stored as favourites.
 - Favourites: 1 to 8 stations for DAB+ radio stations and FM radio stations.

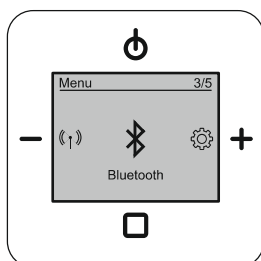

Fig. 35: Bluetooth®

Bluetooth® (3 / 5), see the chapters regarding Bluetooth® from Chapter 9.3.16 "Menu "Bluetooth" - "Mode"" on page 66

- Here the Bluetooth settings of the flush-mounted radio and the connection with an external multimedia device are managed.

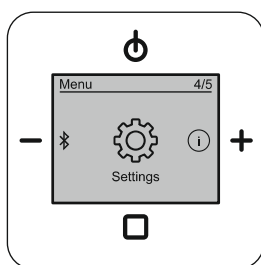

Fig. 36: Settings

Settings (4 / 5), see the chapters regarding settings from Chapter 9.3.21 "Menu "Settings" - "Language"" on page 71

- Here the device settings are carried out, e.g. language or display.

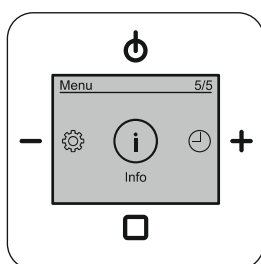

Fig. 37: Info

Info (5 / 5), see the chapters regarding Info from Chapter 9.3.36 "Menu "Info"" on page 89

- Here the information about the device and the firmware is listed.



Notice

Help for navigating through the menus, see chapter 9.4 "Menu tree" on page 92.

9.3.4 Menu "Alarm clock" - "Alarm clock"

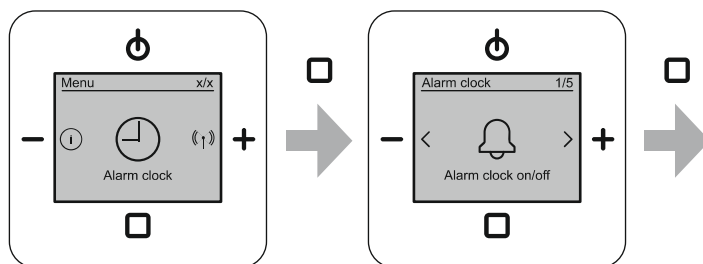

Fig. 38: Alarm clock ON / OFF

The menu is located in menu level "Alarm clock".

The alarm call function is operated via this menu.

Use the following steps to set, activate and deactivate the alarm call function:

1. Switch to menu "Alarm clock".
2. Switch to menu item "Alarm clock ON / OFF".
3. Select menu item "Activate" or "Deactivate".
 - Switch-on:
 - Confirm the activation of the alarm call function with the "ENTER" button.
 - The display shows the "ON" status with the "Alarm clock" icon.
 - Switch-off:
 - Confirm the deactivation of the alarm call function with the "ENTER" button.
 - The alarm call function is deactivated. The "Alarm clock" icon goes out.

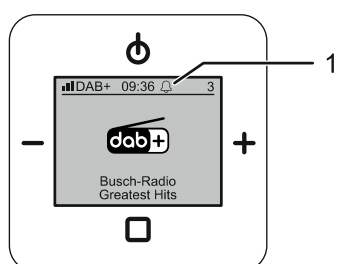

Fig. 39: Main display - "Alarm clock" is active [1]

9.3.5 Menu "Alarm clock" - "Alarm profiles"

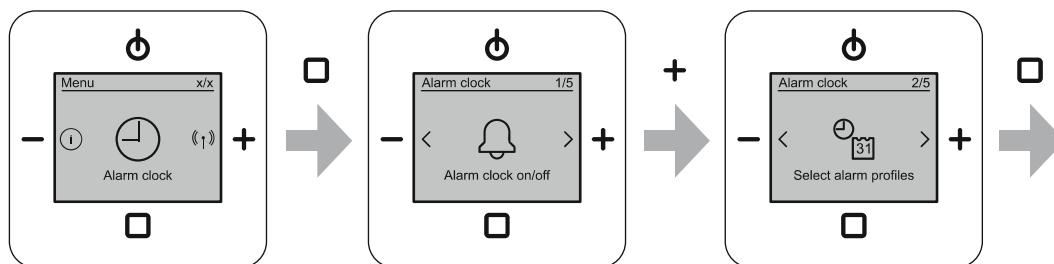

Fig. 40: Select alarm profiles

The menu is located in menu level "Alarm clock".

The selection of an alarm profile simplifies the setting of the alarm times. If you select "All weekdays the same", the alarm times must only be entered once.

Via this menu you select between 3 alarm profiles. Also days can be selected on which the alarm function is to be inactive.

The alarm profile "Working day / weekend (Mon - Fri / Sat - Sun)" is preset. If this is suitable, no alarm profile needs to be selected.

Use the following steps to select an alarm profile:

1. Switch to menu "Alarm clock".
2. Switch to menu item "Select alarm profiles".
3. Select an alarm profile.
4. Confirm the selected alarm profile.

Additional steps:

5. Set the alarm times for the selected alarm profile in menu "Alarm times".
 - Setting alarm times, see chapter 9.3.6 "Menu "Alarm clock" "Alarm times"" on page 55.
 - The alarm times are queried in menu "Set alarm times" in dependence of the selected alarm profile.
6. If necessary, select days on which the alarm function is to be inactive.
 - Deactivate alarm days, see chapter 9.3.7 "Menu "Alarm clock" "Deactivate days"" on page 57.
 - The days selected are deactivated for the alarm clock. This makes it irrelevant which alarm profile has been selected.

Alarm profiles	
Working day / weekend (Mon - Fri / Sat - Sun)	<ul style="list-style-type: none"> ▪ Preset ▪ The alarm times from Monday to Friday are the same. ▪ The alarm times from Saturday to Sunday are the same.
All weekdays the same	The alarm times are the same on every weekday.
Individual weekday.	The alarm times are set separately for each day of the week.

Table 8: Alarm profiles

9.3.6 Menu "Alarm clock" "Alarm times"

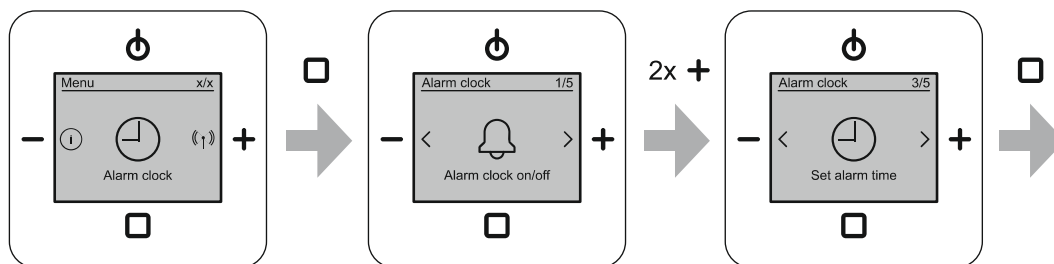

Fig. 41: Setting alarm times

The menu is located in menu level "Alarm clock".

The alarm times are set in dependence of the selected alarm profile. Depending on the alarm profile selected, the necessary alarm times are requested consecutively. To select an alarm profile, see chapter 9.3.5 "Menu "Alarm clock" - "Alarm profiles"" on page 54.

The alarm profile "Working day / weekend (Mon - Fri / Sat - Sun)" is preset. If this is suitable, no alarm profile needs to be selected.



Notice

The alarm times must be entered before the alarm clock is turned on for the first time.

- Only then can the alarm clock be switched on.
- Only then can the alarm days be deactivated.

Use the following steps to set the alarm times:

1. Switch to menu "Alarm clock".
2. Switch to menu item "Set alarm time".
 - The alarm time is requested depending on the set alarm profile.
 - The hours and minutes are set for every alarm time.
3. Set the desired alarm times.
 - Set the hours of an alarm time with the buttons "PLUS / MINUS" and confirm the entry with the "ENTER" button.
 - The menu automatically switches to the next setting option.
 - Set the minutes of an alarm time with the buttons "PLUS / MINUS" and confirm the entry with the "ENTER" button.
 - The menu automatically switches to the next day to be set.
 - After confirming the last time to be set, the display switches automatically back to the "Set alarm time" menu.

Alarm times for the alarm profile "Working day / weekend (Mon - Fri / Sat - Sun)"	
Block 1 (Weekdays) – Mon - Fri	<ul style="list-style-type: none"> ▪ Hours ▪ Minutes
Block 2 (Weekend) – Sat - Sun	<ul style="list-style-type: none"> ▪ Hours ▪ Minutes
Alarm times for the alarm profile "All weekdays the same"	
Mon - Sun	<ul style="list-style-type: none"> ▪ Hours ▪ Minutes
Alarm times for the alarm profile "Individual weekday"	
Mon Tue Wed Thu Fri Sat Sun	<p>All 7 weekdays are entered consecutively.</p> <ul style="list-style-type: none"> ▪ Hours ▪ Minutes

Table 9: Setting alarm times

9.3.7 Menu "Alarm clock" "Deactivate days"

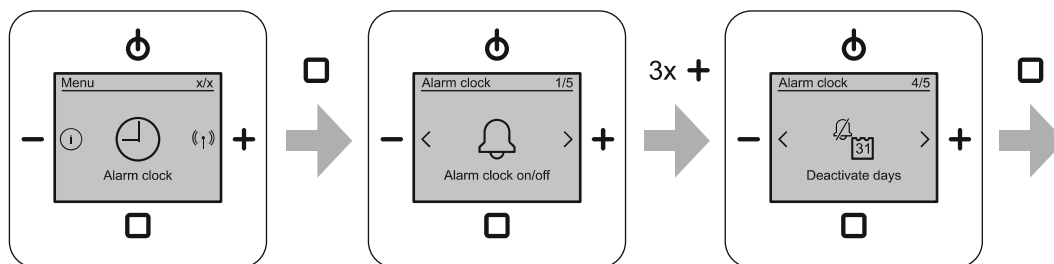

Fig. 42: Deactivate alarm days

The menu is located in menu level "Alarm clock".

In this function, individual days can be excluded from the alarm. Here it is irrelevant which alarm profile is selected in the settings.

Use the following steps to deactivate alarm days:

1. Switch to menu "Alarm clock".
2. Switch to menu item "Deactivate days".
 - A list with weekdays is displayed.
 - All active weekdays have a tick. All weekdays are active after commissioning.
3. Navigate consecutively the the desired days with buttons "PLUS / MINUS" and confirm each selection with the "ENTER" button.
 - The tick at each selected day is deleted. No alarm sounds on the days without a tick.

Use the following steps to activate alarm days that are deactivated:

1. Navigate to the previously deactivated alarm days.
 - Deactivated days do not have a tick.
2. Confirm each desired deactivated alarm day with the "ENTER" button.
 - The tick for the confirmed days is again added. The alarm sounds again on this day.

9.3.8 Menu "Alarm clock" – "Specifying "Signal tones"

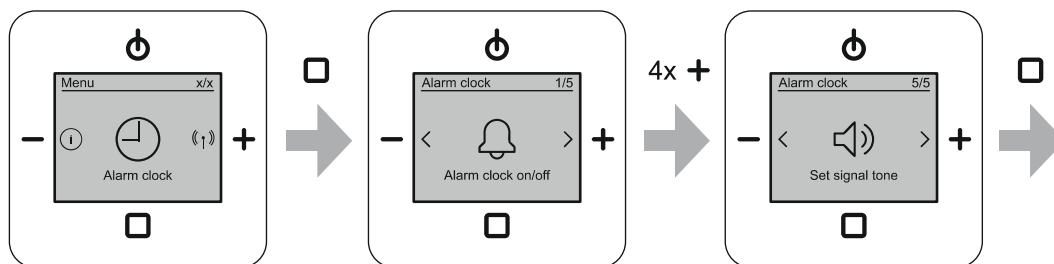

Fig. 43: Specifying signal tone

The menu is located in menu level "Alarm clock".

This menu item is used to select an signal tone for the alarm clock.

Use the following steps to select the signal tone:

1. Switch to menu "Alarm clock".
2. Switch to menu item "Specify signal tone".
 - The display shows the selection for the alarm clock.
3. For the signal tone, switch between the selection "Signal tone" or "Radio".
4. Confirm the selection for the signal tone.
 - The signal tones are now set.

Signal tones	
Play radio	<ul style="list-style-type: none"> ▪ Preset ▪ The favourite station is played when the alarm times is reached.
Tone signal	When the alarm time is reached a tone signal is output.

Table 10: Signal tones

9.3.9 Menu "Station" "Display station list DAB+ " and save favourites

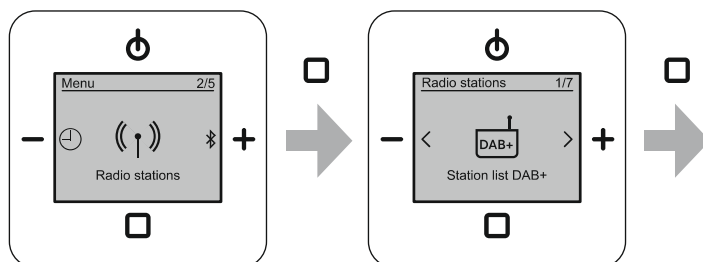

Fig. 44: Display station list DAB+

The menu is located in menu level "Radio stations".

All located DAB+ stations are displayed in this station list.

- To search for DAB+ stations, see chapter 9.3.11 "Menu "Stations" - "Automatic search mode DAB+"" on page 61.

Individual stations can be selected in the station list and played temporarily or saved as favourite.

Of the available stations in the station list up to 8 stations can be stored as favourites.

Use the following steps to temporarily play a station:

1. Switch to menu "Radio stations".
2. Switch to menu item "Station list DAB+".
3. Use the "PLUS / MINUS" buttons to navigate to a station.
4. Confirm the selection with a brief press of the "ENTER" button.
 - The selected station is temporarily stored as favourite "0".
 - If the station is temporarily stored as favourite "0", the device switches to standard operation and plays the station.
 - If a different favourite is selected during standard operation or the device is switched off, the stored favourite "0" is then no longer available.

Use the following steps to save a station as favourite:

1. Switch to menu "Radio stations".
2. Switch to menu item "Station list DAB+".
3. Use the "PLUS / MINUS" buttons to navigate to a station.
4. Confirm the selection with a long press of the "ENTER" button.
 - The selected station is stored as favourite and added at the end of the favourites list.
 - If the favourite is to be placed at a different position, see chapter 9.3.14 "Menu "Station" - "Move favourites"" on page 64.
 - After the favourite is saved the device remains in menu item "Station list DAB". Additional DAB+ stations can be added.
 - If all favourite positions are occupied, a warning message is displayed. In this case, first delete favourites from the favourites list, see chapter 9.3.15 "Menu "Station" - "Delete favourites"" on page 65.

9.3.10 Menu "Station" "Display station list FM" and save favourites

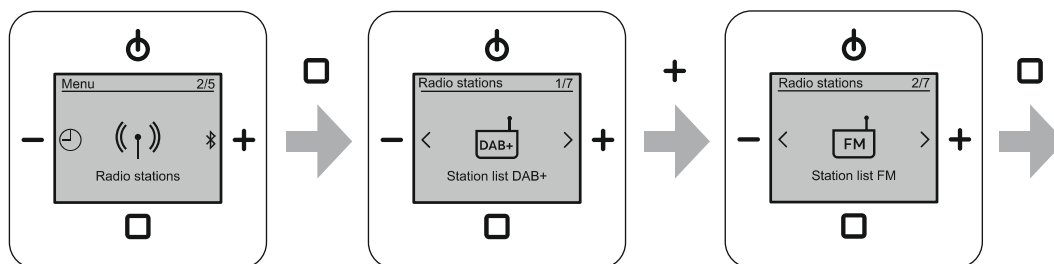

Fig. 45: Display station list FM

The menu is located in menu level "Radio stations".

All located FM stations are displayed in this station list.

- To search for FM stations, see chapter 9.3.12 "Menu "Stations" - "Automatic search mode for FM stations"" on page 62.

Individual stations can be selected in the station list and played temporarily or saved as favourite.

Of the available stations in the station list up to 8 stations can be stored as favourites.

Use the following steps to temporarily play a station:

1. Switch to menu "Radio stations".
2. Switch to menu item "Station list FM".
3. Use the "PLUS / MINUS" buttons to navigate to a station.
4. Confirm the selection with a brief press of the "ENTER" button.
 - The selected station is temporarily stored as favourite "0".
 - If the station is temporarily stored as favourite "0", the device switches to standard operation and plays the station.
 - If a different favourite is selected during standard operation or the device is switched off, the stored favourite "0" is then no longer available.

Use the following steps to save a station as favourite:

1. Switch to menu "Radio stations".
2. Switch to menu item "Station list FM".
3. Use the "PLUS / MINUS" buttons to navigate to a station.
4. Confirm the selection with a long press of the "ENTER" button.
 - The selected station is stored as favourite and added at the end of the favourites list.
 - If the favourite is to be placed at a different position, see chapter 9.3.14 "Menu "Station" - "Move favourites"" on page 64.
 - After the favourite is saved the device remains in menu item "Station list FM". Additional FM stations can be added.
 - If all favourite positions are occupied, a warning message is displayed. In this case, to delete favourites from the list, see chapter 9.3.15 "Menu "Station" - "Delete favourites"" on page 65.

9.3.11 Menu "Stations" - "Automatic search mode DAB+"

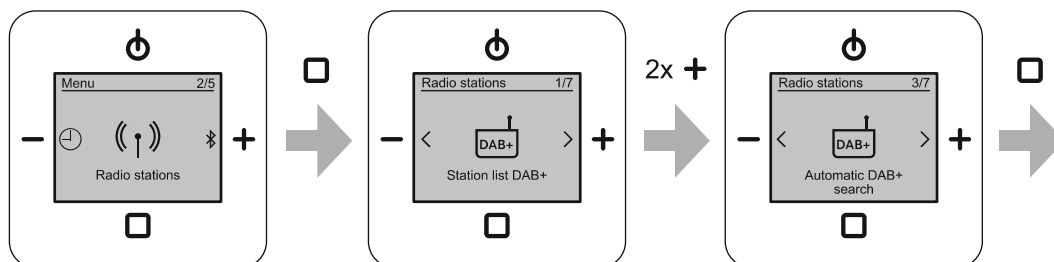

Fig. 46: Automatic DAB+ search mode

The menu is located in menu level "Radio stations".

Via this menu the device searches through the entire frequency range for DAB+ stations and creates a station list of all DAB+ stations found. The DAB+ stations in the list are sorted from 0 to 9 and then from A to Z.

Use the following steps to automatically search for DAB+ stations:

1. Switch to menu "Radio stations".
2. Switch to menu item "Automatic DAB+ search".
 - The device creates a list of all located DAB+ stations.
 - If a station is located several times, it is only taken into the list once.
 - After completion of the automatic search mode the device automatically returns to menu item "DAB+ station list".
 - The newly created station list is displayed in menu item "DAB+ station list".
 - The stations can be selected in menu item "DAB+ station list" and played temporarily or saved as favourite.
 - To switch to menu item "DAB+ station list", see chapter 9.3.9 "Menu "Station" "Display station list DAB+ " and save favourites" on page 59.

9.3.12 Menu "Stations" - "Automatic search mode for FM stations"

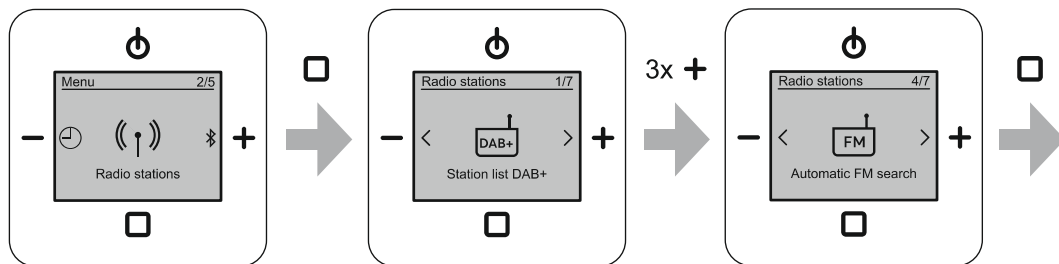

Fig. 47: Automatic FM search mode

The menu is located in menu level "Radio stations".

Via this menu the device searches through the entire frequency range for FM stations and creates a station list of all FM stations found. The FM stations in the list are sorted in ascending order.

Use the following steps to automatically search for FM stations:

1. Switch to menu "Radio stations".
2. Switch to menu item "Automatic FM search".
 - The device creates a list of all located FM stations.
 - If a station is located several times, it is only taken into the list once.
 - After completion of the automatic search mode the device automatically returns to menu item "Station list FM".
 - The newly created station list is displayed in menu item "Station list FM".
 - The stations can be selected in menu item "Station list FM" and played temporarily or saved as favourite.
 - To switch to menu item "Station list FM", see chapter 9.3.10 "Menu "Station" "Display station list FM" and save favourites" on page 60.

9.3.13 Menu "Station" – "Setting FM stations manually"

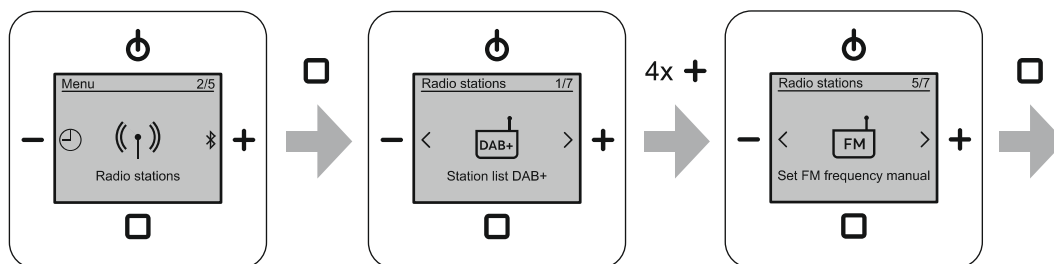

Fig. 48: Setting FM stations manually

The menu is located in menu level "Radio stations".

Via this menu you search through the entire frequency range for FM stations. The stations that are found can be played temporarily or saved as favourite.

Use the following steps to manually search for FM stations:

1. Switch to menu "Radio stations".
2. Switch to menu item "Set FM frequency manually".
3. Use the "PLUS / MINUS" buttons to search for a FM station manually.
 - With a brief press of the "PLUS / MINUS" buttons the displayed frequency changes by 0.05 MHz respectively.
 - With a long press (longer than 1 second) of the "PLUS / MINUS" buttons the frequency changes automatically to the next located station and stops there.

The located station can be played temporarily.

- Confirm the selection with a brief press of the "ENTER" button.
 - The selected station is temporarily stored as favourite "0".
 - If the station is temporarily stored as favourite "0", the device switches to standard operation and plays the station.
 - If a different favourite is selected during standard operation or the device is switched off, the stored favourite "0" is then no longer available.

Save the located station as favourite.

- Confirm the selection with a long press of the "ENTER" button.
 - The selected station is stored as favourite and added at the end of the favourites list.
 - If the favourite is to be placed at a different position, see chapter 9.3.14 "Menu "Station" - "Move favourites"" on page 64.
 - After the favourite is saved the device remains in menu item "Set FM frequency manually". Additional FM stations can be added.
 - If all favourite positions are occupied, a warning message is displayed. In this case, to delete favourites from the list, see chapter 9.3.15 "Menu "Station" - "Delete favourites"" on page 65.

9.3.14 Menu "Station" - "Move favourites"

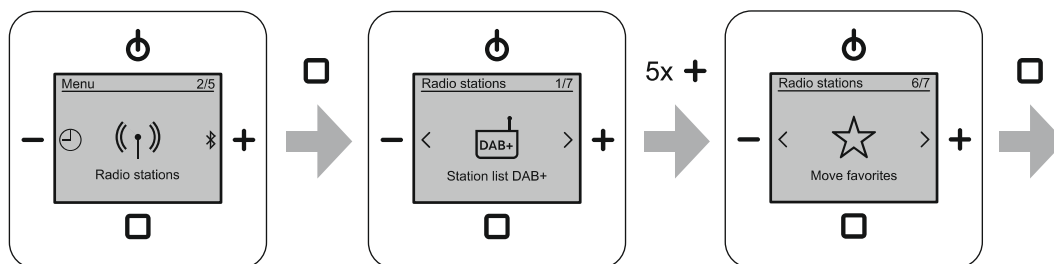

Fig. 49: Move favourites

The menu is located in menu level "Radio stations".

Via this menu you move the saved favourites within the list. The selected favourite is inserted at the selected position. The remaining saved favourites remain unchanged in their order.

Use the following steps to exchange favourites:

1. Switch to menu "Radio stations".
2. Switch to menu item "Move favourites".
3. Switch to the desired favourite with the "PLUS / MINUS" buttons.
4. Confirm the selection with a brief press of the "ENTER" button.
 - The question "Move favourite?"
5. Move the selected favourite to the desired position with the "PLUS / MINUS" buttons.
 - Confirm the new position with a brief press of the "ENTER" button.

9.3.15 Menu "Station" - "Delete favourites"

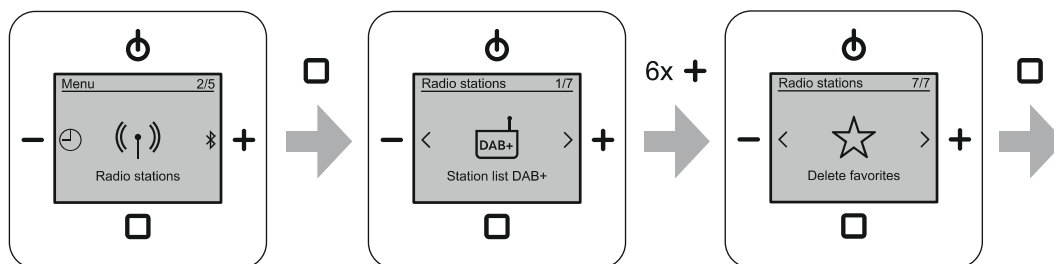

Fig. 50: Delete favourites

The menu is located in menu level "Radio stations".

This menu is used to delete the stored stations from the list of favourites.

Use the following steps to delete a favourite:

1. Switch to menu "Radio stations".
2. Switch to menu item "Delete favourites".
3. Switch to the desired favourite with the "PLUS / MINUS" buttons.
4. Delete the selected station from the list with a brief press of the "ENTER" button.
 - The station will be deleted from the list of favourites without any further enquiry.
 - All the following favourites move one position forward. No gaps can exist between the saved favourites.

9.3.16 Menu "Bluetooth" - "Mode"

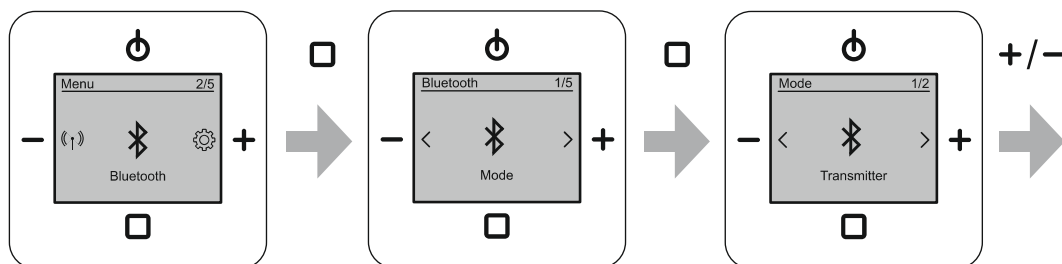

Fig. 51: Bluetooth mode

The menu is located in menu level "Settings".

Select from the following setting options:

Menu function	Description
Station	<ul style="list-style-type: none"> The coupling and connecting with a different Bluetooth multimedia device (e.g. loudspeaker, headphone) is generally made from the flush-mounted radio or, if necessary, from the other Bluetooth multimedia device. The music of the flush-mounted radio is played on the connected multimedia device. The favourite "Bluetooth" is deactivated.
Receivers	<ul style="list-style-type: none"> The coupling and connecting with a different Bluetooth multimedia device (e.g. smartphone) is made from the other Bluetooth multimedia device. The music of the connected Bluetooth multimedia device is played on the flush-mounted radio. The favourite "Bluetooth" is activated. The Bluetooth function "Connect device" is deactivated. The Bluetooth function "Couple new device" is deactivated.

Table 11: Bluetooth mode

Use the following steps to set the Bluetooth mode:

1. Switch to menu "Bluetooth".
2. Switch to menu item "Mode".
3. Switch to the submenu "Station" of menu item "Mode".
4. Use the (PLUS / MINUS) buttons to switch to the desired setting "Station" or "Receiver".
5. Confirm the selection with a brief press of the "ENTER" button.

9.3.17 Menu "Bluetooth" – "Connect device"

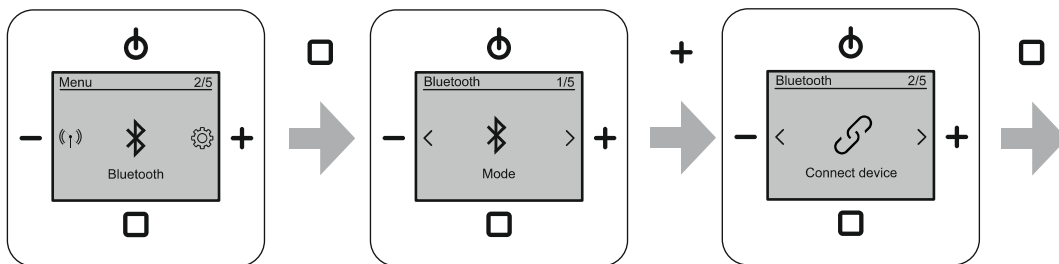

Fig. 52: Connect Bluetooth device

This menu is only visible when the Bluetooth mode in the settings is set on "Station, see chapter 9.3.16 "Menu "Bluetooth" - "Mode"" on page 66.

The menu is located in menu level "Bluetooth".

Via this menu you establish the connection from the flush-mounted radio to a Bluetooth multimedia device (e.g. loudspeaker, headphone).

Establishing a connection:

Use the following steps to establish the connection:

1. Switch to menu "Bluetooth".
2. Switch to menu item "Connect device".
3. Switch to the submenu of menu item "Connect device".
 - The device switches to the devices in the list that are already coupled. If no device is displayed in the list, a device must first be coupled, see chapter 9.3.18 "Menu "Bluetooth" – "Couple device"" on page 68.
4. Use the "PLUS / MINUS" buttons to switch to the desired coupled device.
 - All Bluetooth devices are displayed in the list. However, only the connection to the Bluetooth receivers can be established.
 - Please ensure that the device to be coupled is switched on and Bluetooth® is activated.
5. Confirm the selection with a brief press of the "ENTER" button.
 - The devices are connected with each other.

9.3.18 Menu "Bluetooth" – "Couple device"

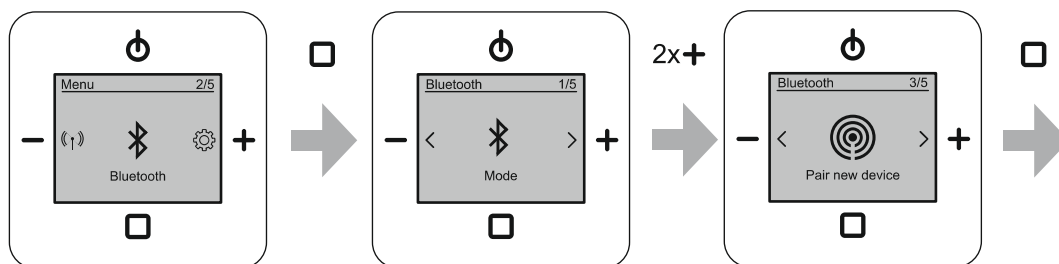

Fig. 53: Bluetooth®: Pair new device

This menu is only visible when the Bluetooth mode in the settings is set on "Station, see chapter 9.3.16 "Menu "Bluetooth" - "Mode"" on page 66.

The menu is located in menu level "Bluetooth".

Via this menu you establish the pairing from the flush-mounted radio to a Bluetooth multimedia device.

Pairing starting from the flush-mounted radio (only possible in Bluetooth mode "Station")

Use the following steps to establish the pairing:

1. Switch to menu "Bluetooth".
2. Switch to menu item "Pair new device".
3. Switch to the submenu of menu item "Pair new device".
 - The device switches to the list of available Bluetooth devices that are within range. If no device is displayed in the list, no device is within the range of the flush-mounted radio.
 - Please ensure that the device to be paired is switched on and the pairing mode is activated there.
 - The search for external Bluetooth devices takes place automatically. As soon as a Bluetooth device is within range or leaves the range, the list is updated.
4. Use the "PLUS / MINUS" buttons to switch to the desired device.
5. Confirm the selection with a brief press of the "ENTER" button.
 - The Bluetooth device is paired with the flush-mounted radio.

Pairing starting from the external Bluetooth device

Pairing starting from the external Bluetooth device is possible only in the "Receiver" mode of the flush-mounted radio.

The operation of the external Bluetooth device depends on the external Bluetooth device.

The flush-mounted radio must be switched on for the pairing process.

- Nothing special needs to be set on the flush-mounted radio.
- No special function needs to be switched to in the flush-mounted radio.

9.3.19 Menu "Bluetooth" – "Disconnect active device"

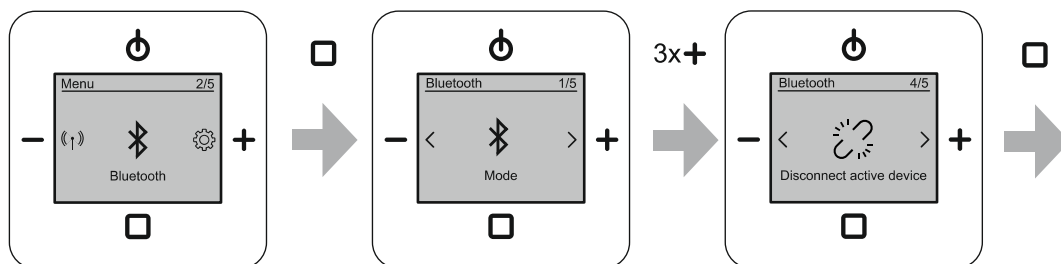

Fig. 54: Disconnect active Bluetooth device

The menu is located in menu level "Bluetooth".

This menu is used to disconnect a Bluetooth device from the flush-mounted radio.

Cutting the connection:

Use the following steps to cut the connection:

1. Switch to menu "Bluetooth".
2. Switch to menu item "Disconnect active device".
3. Confirm the disconnection with the "ENTER" button.
 - The Bluetooth device will be disconnected.
 - The Bluetooth device remains in the list of coupled devices and can be reconnected there when it is within range.

9.3.20 Menu "Bluetooth" – "Uncoupling all devices"

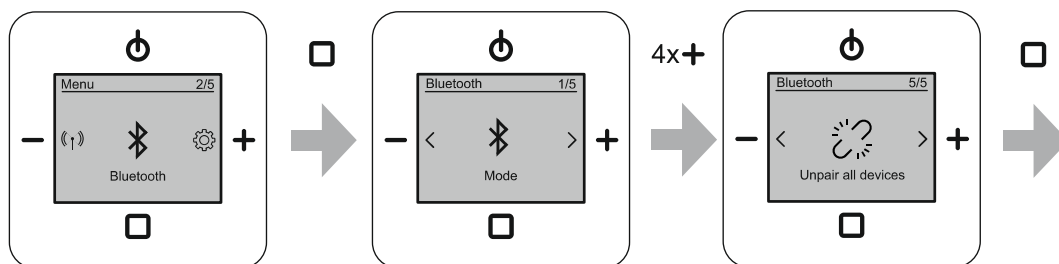

Fig. 55: Unpairing all Bluetooth devices

The menu is located in menu level "Bluetooth".

All Bluetooth devices in the list are unpaired via this menu. The connection data of the Bluetooth devices are then also deleted.

Devices that were once connected must then be paired again.

Use the following steps to unpair the Bluetooth devices:

1. Switch to menu "Bluetooth".
2. Switch to menu item "Unpairing all devices".
3. Confirm the unpairing of the stored Bluetooth devices with the "ENTER" button.
 - The data of all paired Bluetooth devices will be deleted.

9.3.21 Menu "Settings" - "Language"

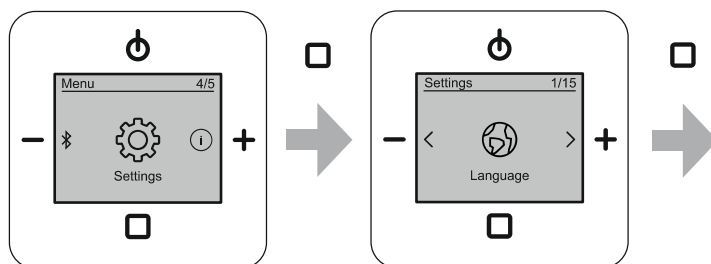

Fig. 56: Select the local language

This menu is used to set your local language.

Use the following steps to select the language:

1. Switch to menu item "Settings".
2. Switch to menu item "Language".
3. Use the "PLUS / MINUS" buttons to select a language.
4. Confirm the selection with the "ENTER" button.

Foreign language is set

If a foreign language has been set, use the following steps for a reset:

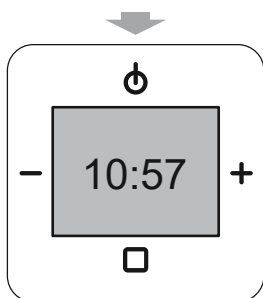

Fig. 57: Switching the radio on

1. Switch the flush-mounted radio on.
 - Tap on the "ON / OFF" button.

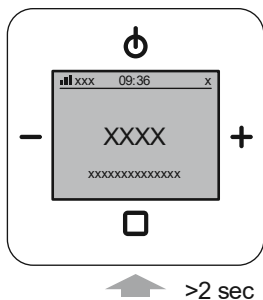

Fig. 58: Foreign language "Main menu"

2. Press the "ENTER" button for at least 2 seconds.
 - The device switches to the menu dialogue used last.

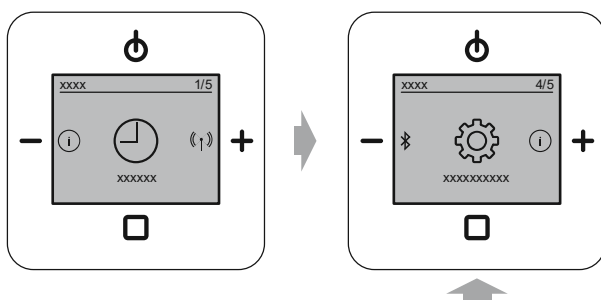

Fig. 59: "Foreign language "Settings"

- The right numeral of the menu number must be a "5".
3. Switch to menu number "4/5" with the "PLUS" button.
 4. Switch to the menu with the "ENTER" button.
 - The device switches to the settings in sub-menu "Settings".

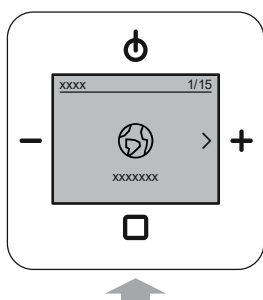

Fig. 60: "Foreign language "Language menu"

- The right numeral of the menu number must be a "15".
5. Switch to menu number "1/15" with the "PLUS" button if the menu number does not yet show "1/15".
 6. Switch to the menu with the "ENTER" button.

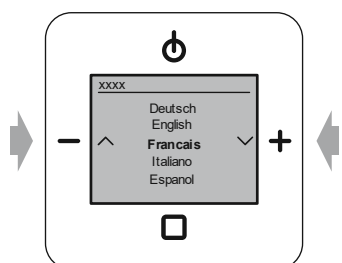

Fig. 61: "Foreign language "Language menu"

- The current language will be displayed.
7. Switch to your language with the "PLUS" button.
 8. Confirm your language with the "ENTER" button.
 - The device changes the language.

9.3.22 Menu "Settings -"Bass"

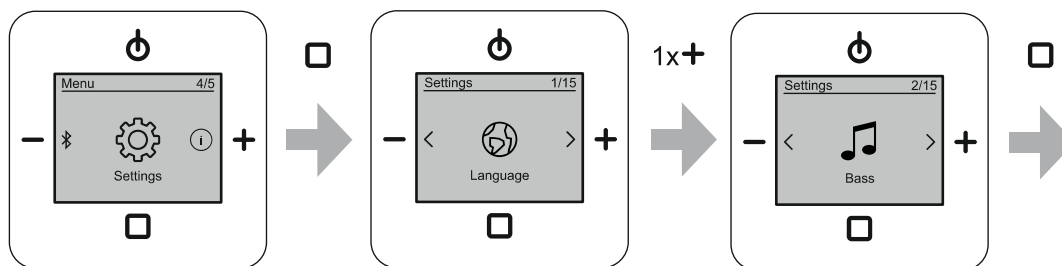

Fig. 62: Bass

The menu is located in menu level "Settings". This menu contains the "Bass" sound regulator. In this menu you set the low frequencies of the replayed music. The setting greatly depends on personal taste and on the loudspeakers used. Therefore, an optimal setting can only be determined by means of "testing".

Select from the following setting options:

Setting	Description
Bass	Deep tones in the hearing range of the human ear <ul style="list-style-type: none"> ▪ Adjustment range: -5dB to +5 dB ▪ The default setting in the device: 0 dB

Fig.12: Bass

Use the following steps to set the depth:

1. Switch to menu item "Settings".
2. Switch to menu item "Bass".
3. Use the "PLUS / MINUS" buttons to select the desired setting.
4. Confirm the selection with the "ENTER" button.

9.3.23 Menu "Settings" - "Treble"

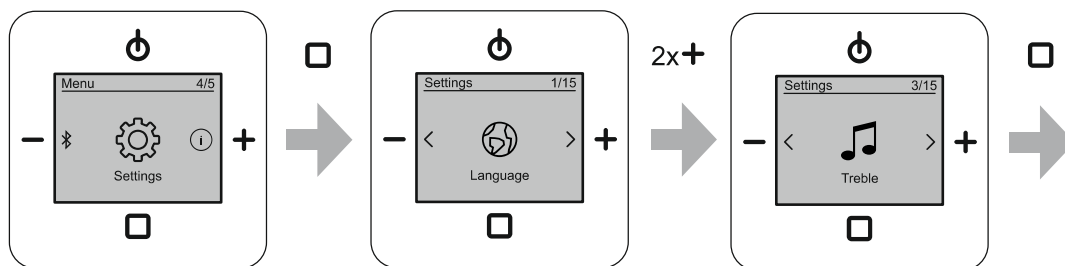

Fig. 63: Treble

The menu is located in menu level "Settings". This menu contains the "Treble" sound regulator.

In this menu you set the high frequencies of the replayed music. The setting greatly depends on personal taste and on the loudspeakers used. Therefore, an optimal setting can only be determined by means of "testing".

Select from the following setting options:

Setting	Description
Treble	High tones in the hearing range of the human ear <ul style="list-style-type: none"> ▪ Adjustment range: -5dB to +5 dB ▪ The default setting in the device: 0 dB

Table.13: Treble

Use the following steps to set the treble:

1. Switch to menu item "Settings".
2. Switch to menu item "Treble".
3. Use the "PLUS / MINUS" buttons to select the desired setting.
4. Confirm the selection with the "ENTER" button.

9.3.24 Menu "Settings" - "Start volume"

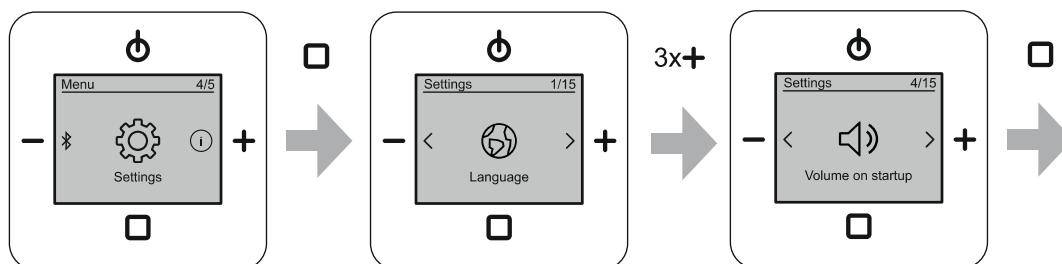

Fig. 64: Start volume

The menu is located in menu level "Settings".

In this menu set the volume the device has after being switched on.

Select from the following setting options:

Start volume	Description
Last volume	The device starts with the last volume.
Fixed volume	The device saves the current volume. The device then starts with this volume each time it is switched on.

Table 14: Start volume

Use the following steps to set the start volume:

1. Switch to menu item "Settings".
2. Switch to menu item "Start volume".
3. Use the "PLUS / MINUS" buttons to select the setting.
4. Confirm the selection with the "ENTER" button.

9.3.25 Menu "Settings - "Maximum volume"



Attention! Low alarm sound

With the reduction of the maximum volume also the volume of the alarm sound is reduced.

- Take this into consideration when you reduce the maximum volume of the device.

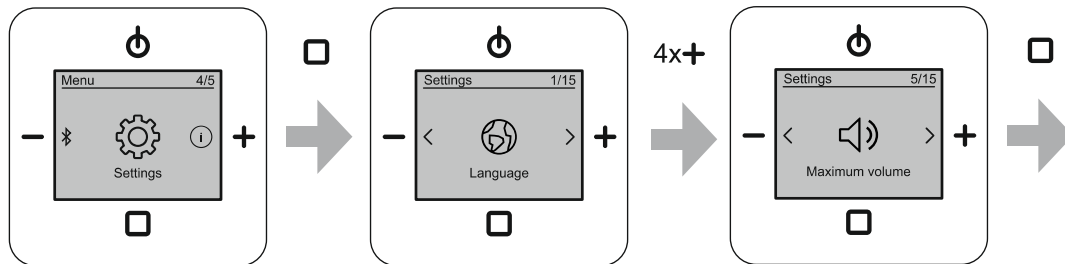

Fig. 65: Maximum volume

The menu is located in menu level "Settings".

In this menu you set the maximum volume the device reaches.

- If the maximum volume of the device is reduced, the volume bar can be moved up to this value during standard operation.

Use the following steps to set the maximum volume:

1. Switch to menu item "Settings".
2. Switch to menu item "Maximum volume".
3. Use the "PLUS / MINUS" buttons to select the setting.
4. Confirm the selection with the "ENTER" button.

9.3.26 Menu "Settings" - "AUX"

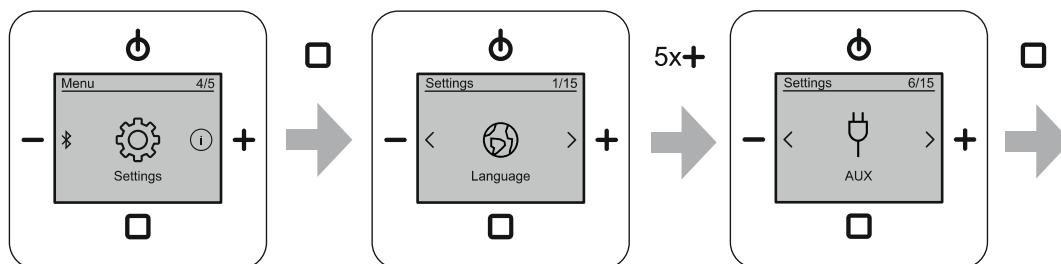

Fig. 66: AUX setting

The menu is located in menu level "Settings".

In this menu you specify whether the AUX connection serves as input or output. It can also be deactivated.

Select from the following setting options:

Setting	Description
Deactivated	The AUX function of the flush-mounted radio has been deactivated. <ul style="list-style-type: none"> Favourite "AUX" (last favourite position) has been deactivated in the favourites.
AUX Input	An external source can be played in the flush-mounted radio. <ul style="list-style-type: none"> Favourite "AUX" (last favourite position) has been activated in the favourites. Select favourite "AUX" to play the external source.
AUX Output	A favourite of the flush-mounted radio can be played on an external device. <ul style="list-style-type: none"> Favourite "AUX" (last favourite position) has been deactivated in the favourites.

Table. 15: AUX setting

Use the following steps to set the AUX connections:

1. Switch to menu item "Settings".
2. Switch to menu item "AUX".
3. Use the "PLUS / MINUS" buttons to select the desired selection.
4. Confirm the selection with the "ENTER" button.

9.3.27 Menu "Settings" – "AUX input gain"

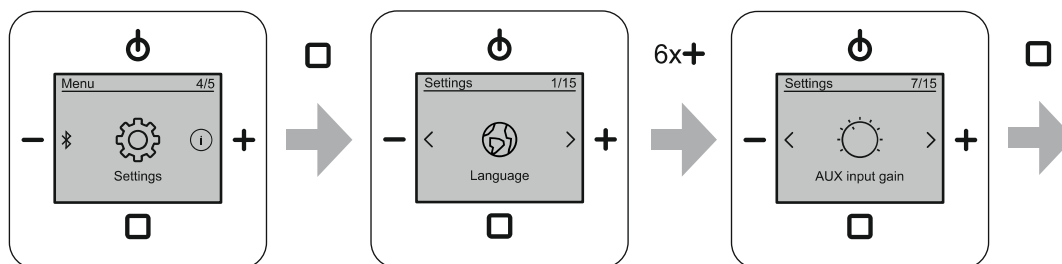

Fig. 67: AUX input gain

The menu is located in menu level "Settings".

In this menu the input gain for AUX is set. With this setting, for example, you align the volumes of the devices connected with each other via AUX.

Select from the following setting options:

Setting	Description
AUX input gain	<ul style="list-style-type: none"> Adjustment range: 0 dB, 3 dB, 6 dB, 9 dB The default setting in the device: 0 dB

Table 16: AUX input gain

Use the following steps to set the input sensitivity:

1. Switch to menu item "Settings".
2. Switch to menu item "AUX input gain".
3. Use the "PLUS / MINUS" buttons to select the desired setting.
4. Confirm the selection with the "ENTER" button.

9.3.28 Menu "Settings" - "Display profile"

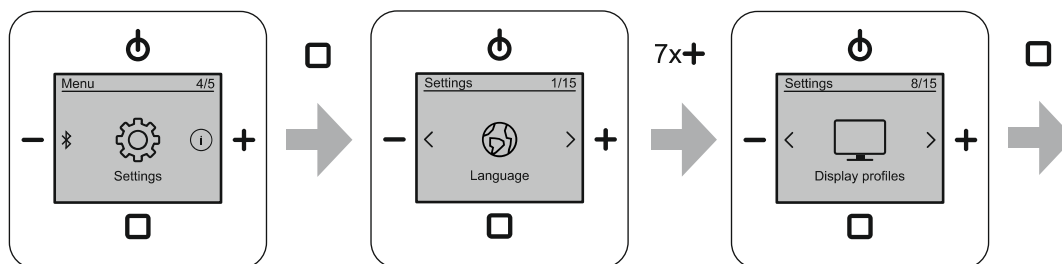

Fig. 68: Display profiles

The menu is located in menu level "Settings". In this menu the different indications of the display are selected.

With a profile selection from this menu you represent certain contents of the display enlarged.

Select from the following setting options:

Setting		Description	Display view of standard operation
	Standard	In standard operation the display is shown in the standard view.	
	Large letters	In the display of standard operation the station name is shown in large letters instead of the slide show.	
	Large clock	In the display of standard operation the time is shown in large numbers instead of the slide show.	
	Slide show	In the display of standard operation the slide show is shown large after 20 seconds. – When pressing the "ENTER" button the display changes to the standard view for approx. 20 seconds. – During this time the "ENTER" button has the normal function again.	

Table 17: Display profiles

Use the following steps to set the display profile:

1. Switch to menu item "Settings".
2. Switch to menu item "Display profile".
3. Use the "PLUS / MINUS" buttons to select the desired setting.
4. Confirm the selection with the "ENTER" button.

9.3.29 Menu "Settings" - "Display illumination"

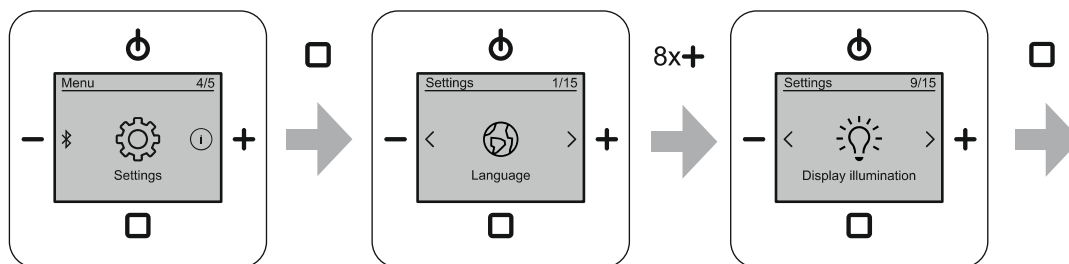

Fig. 69: Display illumination

The menu is located in menu level "Settings".

In this menu you select the scenes for the display illumination.

Select from the following setting options:

Menu function	Description
On	The display is permanently illuminated, when the radio is switched on (standard setting).
Automatic	Without operation the display illumination of the radio reduces itself automatically to a mean value after 30 seconds.
Permanently On	The display is permanently illuminated. – Continuous illumination also in a deactivated state. – Not available in "ECO" mode.

Table 18: Display illumination

Use the following steps to set the display illumination:

1. Switch to menu item "Settings".
2. Switch to menu item "Display illumination".
3. Select the desired illumination.
4. Confirm your selection with the "ENTER" button.

9.3.30 Menu "Settings" - "Display brightness"

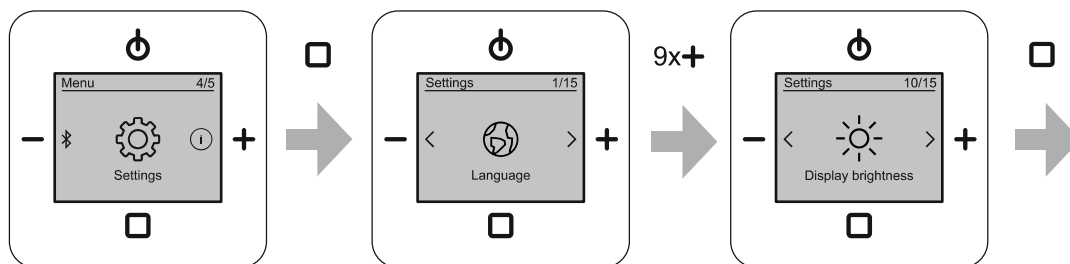

Fig. 70: Display brightness

The menu is located in menu level "Settings".

In this menu the desired display brightness is set.

Use the following steps to set the display brightness:

1. Switch to menu item "Settings".
2. Switch to menu item "Display brightness".
3. Set the brightness with the "PLUS / MINUS" buttons.
4. Confirm the selection with the "ENTER" button.

9.3.31 Menu "Settings" - "Sleep timer" (switch-off time)

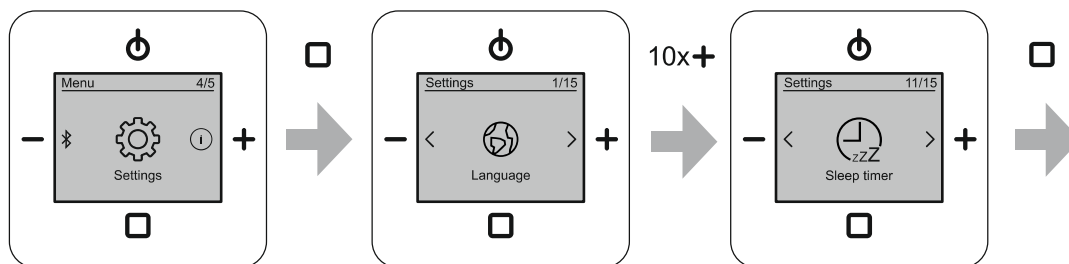

Fig. 71: Sleep timer

The menu is located in menu level "Settings".

After activating the "Sleep timer" function the flush-mounted radio switches itself off automatically at the time set here.

– For activating this function, see chapter 9.2.6 "Sleep function (turn-off time)" on page 37.

The time setting is made in 5 minute steps in a range of 5 to 60 minutes.

Use the following steps to set the sleep timer switch-off time.:

1. Switch to menu item "Settings".
2. Switch to menu item "Sleep timer".
3. Use the "PLUS / MINUS" buttons to select the setting.
4. Confirm the selection with the "ENTER" button.

9.3.32 Menu "Settings" – "Energy efficiency"

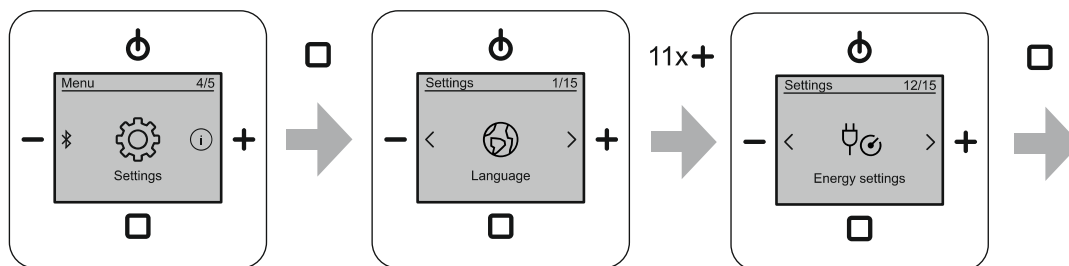

Fig. 72: Energy settings

The menu is located in menu level "Settings".

Select from the following setting options:

Menu function	Description
Eco	The display illumination is dimmed. – Standard setting during commissioning.
Comfort	<ul style="list-style-type: none"> ▪ If the flush-mounted radio is switched off, the flush-mounted radio is switched on automatically when a Bluetooth multimedia device wants to connect itself to the flush-mounted radio. ▪ The display illumination can also be switched on in the OFF status (permanently On), see chapter 9.3.29 "Menu "Settings" - "Display illumination"" on page 81.

Table 19: Energy settings

Use the following steps to set the energy efficiency:

1. Switch to menu item "Settings".
2. Switch to menu item "Energy settings".
3. Use the "PLUS / MINUS" buttons to select the setting.
4. Confirm the selection with the "ENTER" button.

9.3.33 Menu "Settings" - "Extension unit operation"

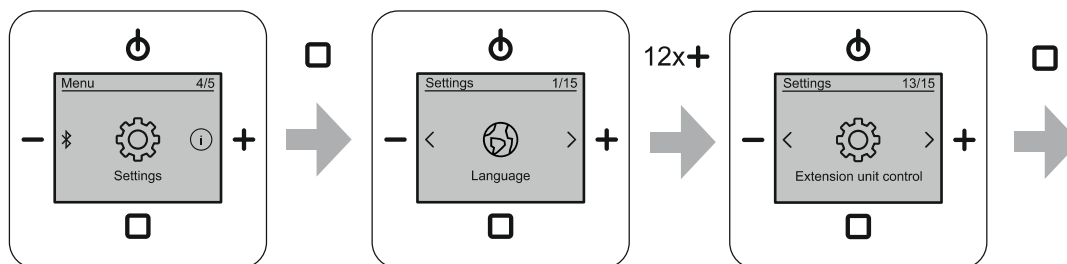

Fig. 73: Extension control

The menu is located in menu level "Settings".

In this menu you set the additional activation / deactivation of the device via an extension unit. E.g. together with a light switch or movement detector when you enter or exit the room.

Select from the following setting options:

Menu function	Description
Switch	Manual selection: A switch is connected at the extension unit input.
Buttons	Manual selection: A button is connected at the extension unit input.
Automatic	Automatic detection of the connected switch or button.

Table 20: Extension unit control

Use the following steps to set the extension unit operation:

1. Switch to menu item "Settings".
2. Switch to menu item "Extension unit control".
3. Use the "PLUS / MINUS" buttons to select the setting.
4. Confirm the selection with the "ENTER" button.

9.3.34 Menu "Settings" - "Antenna"

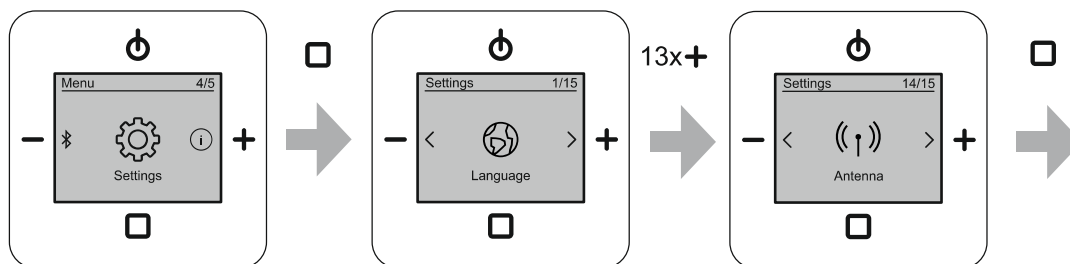

Fig. 74: Antenna

The menu is located in menu level "Settings".

In this menu the available antennas are set.

Select from the following setting options:

Menu function	Description
Internal	The internal antenna of the device is being used.
External	The externally connected antenna of the device is being used. – Antenna and antenna connection: see chapter 7.5.3 "Antenna" on page 25.

Table 21: Antenna

Use the following steps to set the antenna:

1. Switch to menu item "Settings".
2. Switch to menu item "Antenna".
3. Use the "PLUS / MINUS" buttons to select the setting.
4. Confirm the selection with the "ENTER" button.

9.3.35 Menu "Settings" - "Hotel mode"

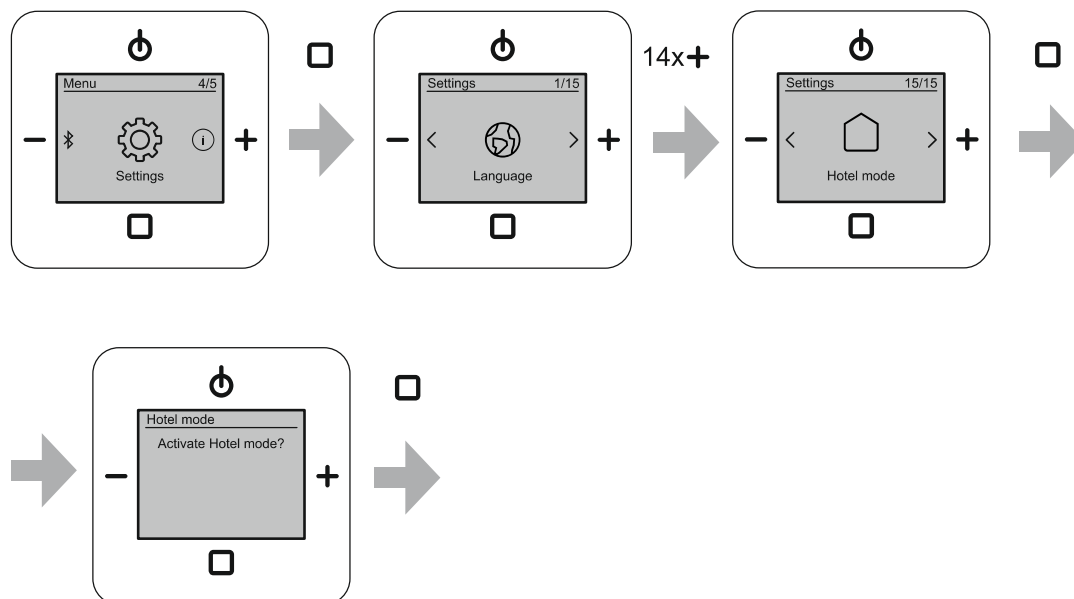

Fig. 75: Hotel mode

The menu is located in menu level "Settings".

In this device mode the functions of the device settings are deactivated. Only the functions for standard operation and selected settings are available that are necessary for standard operation.

In hotel mode the following functions are available:

Menu function	Description
ON / OFF	–
Volume	–
Change to the favourites	<ul style="list-style-type: none"> ▪ The favourite "AUX" is only available when AUX has been set on "AUX input" in the settings. ▪ The favourite "Bluetooth®" is only available when Bluetooth® has been set on "Receiver" in the settings.
Alarm clock	<ul style="list-style-type: none"> ▪ Alarm clock ▪ Selection of the signal tone
Sleep timer (snooze function)	The switch-off time is fixed and is specified before the activation of the hotel mode.
Display station list	<ul style="list-style-type: none"> ▪ DAB+ ▪ FM
RESET (Reset to factory settings)	Deactivated
Bluetooth® settings	Disconnect

Table 22: Available functions in hotel mode

Use the following steps to activate the hotel mode:

1. Switch to menu item "Settings".
2. Switch to menu item "Hotel mode".
3. Switch to the submenu of menu item "Hotel mode".
4. Confirm the selection with a long press of the "ENTER" button (at least 2 seconds).
5. Confirm the security request with a press of the "ENTER" button.



Notice

Carry out the following points to deactivate the hotel mode:

- Switch the device off.
- Reset the switched-off device into the standard mode with a very long press of the ON / OFF button (at least 15 seconds).

9.3.36 Menu "Info"

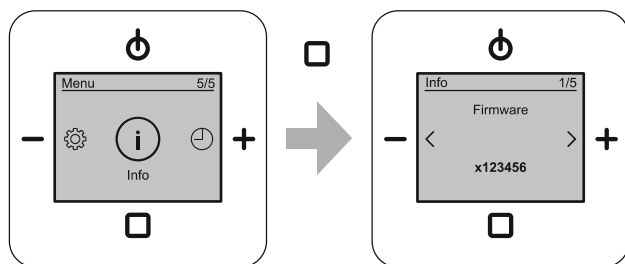

Fig. 76: Info

Display	Info	Description
	Firmware	Here you find the latest software version of your device.
	Device name	Here the name of the device type is displayed.
	Bluetooth address	Here the Bluetooth address of the device is displayed.
	Signal strength	Here the signal strength of the current source is displayed.

	<p>Bluetooth devices</p>	<p>Here the 10 devices connected last are displayed. Also the time of the of the last connection of the device.</p> <ul style="list-style-type: none"> – Press the "ENTER" button to display the devices.
---	--------------------------	--

Table 23: Device information

9.3.37 RESET (resetting to the factory settings)

If you wish to delete all the settings you have made and to re-enter them, the device must first be fully reset to its state at the point of delivery.

Use the following steps to reset the device:

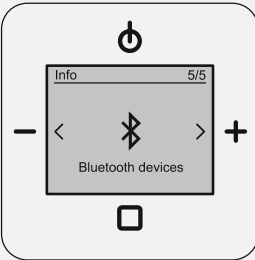
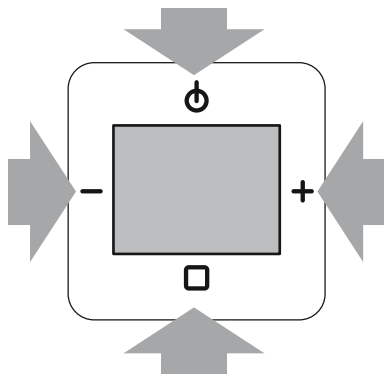
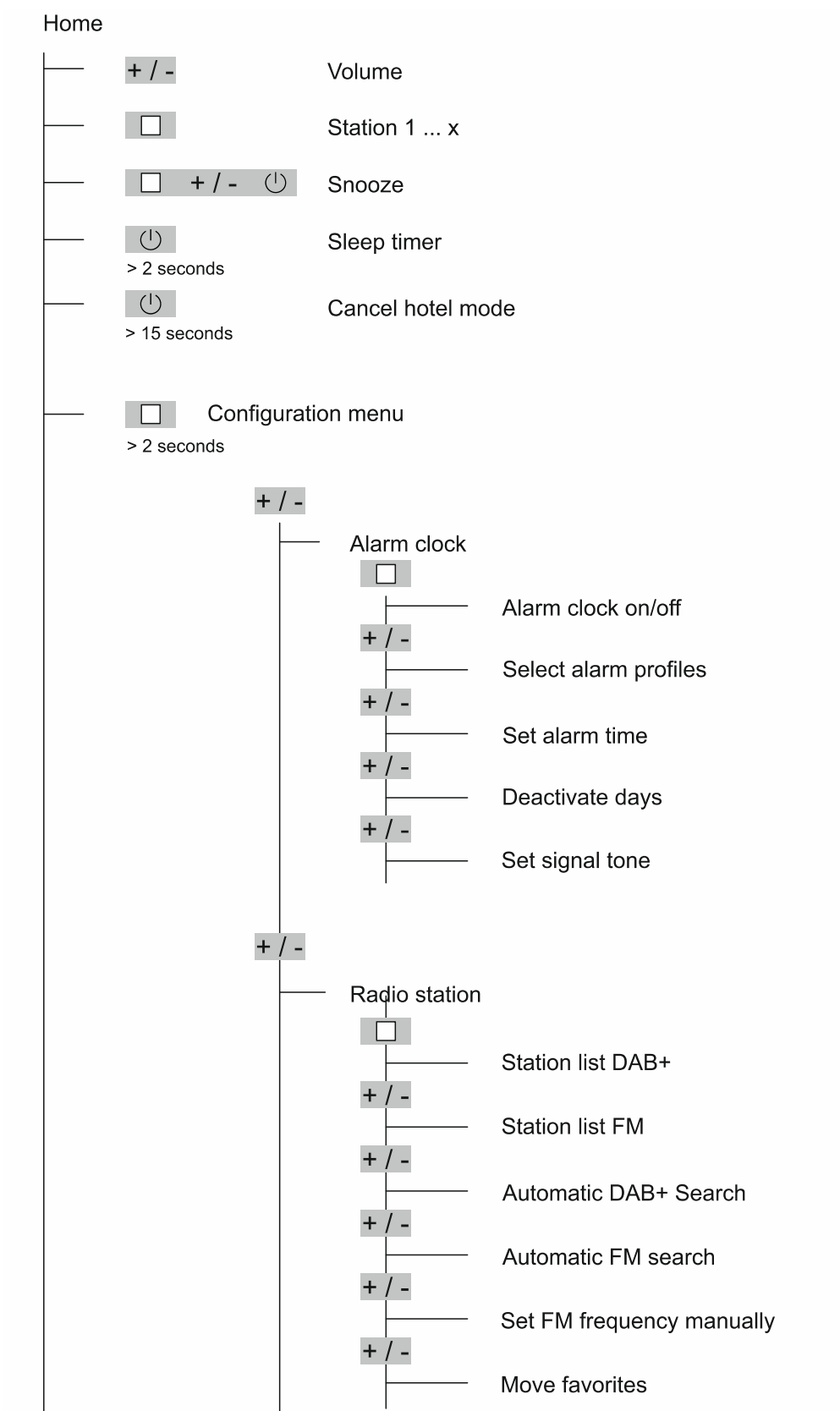
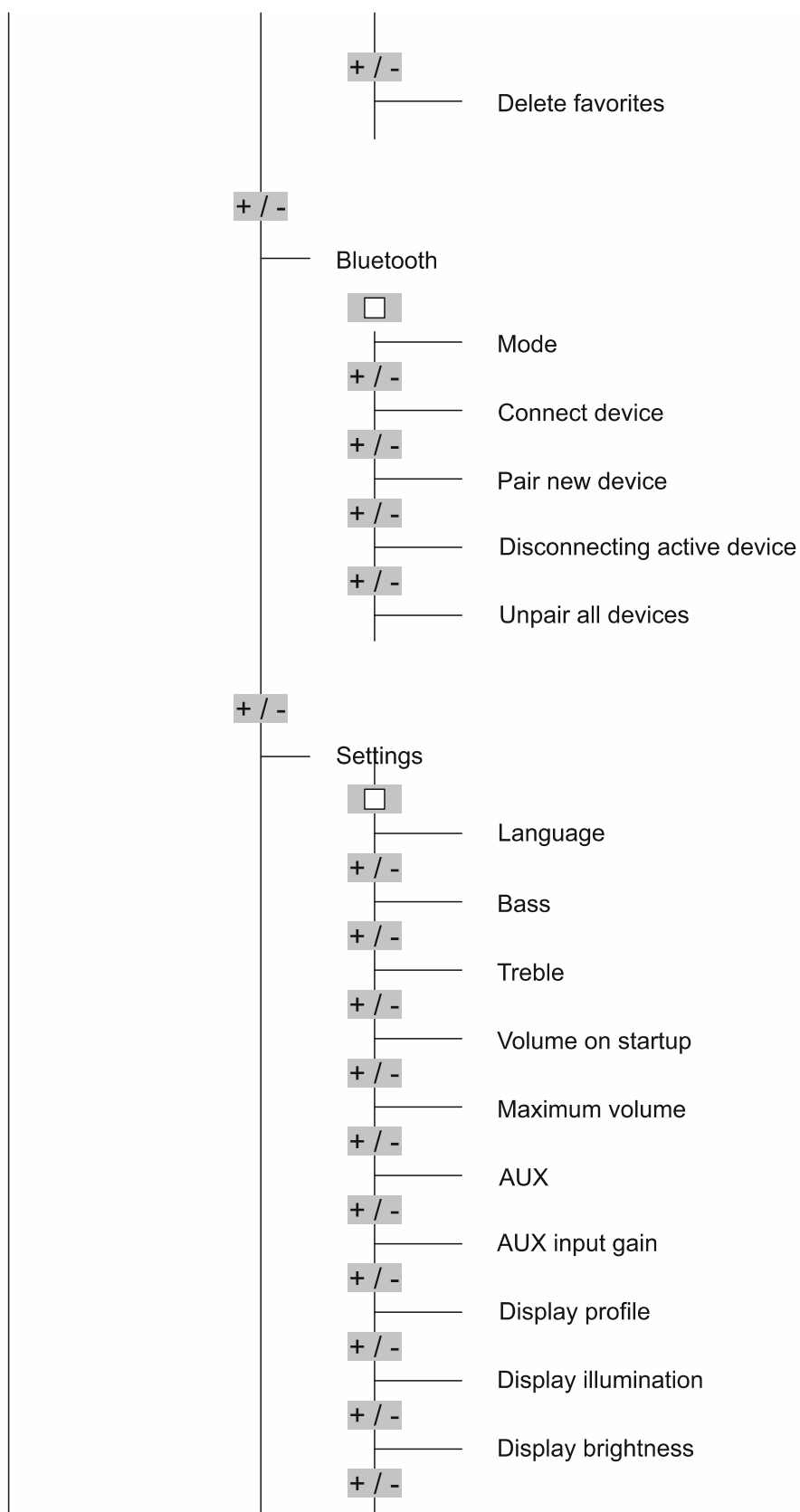

Fig. 77: Resetting the device

1. Press all four buttons on the device simultaneously for approximately 5 seconds.
 - All settings made are deleted.
 - The device switches to initial commissioning. To perform initial commissioning, see chapter 8 “Commissioning” on page 26.

9.4 Menu tree





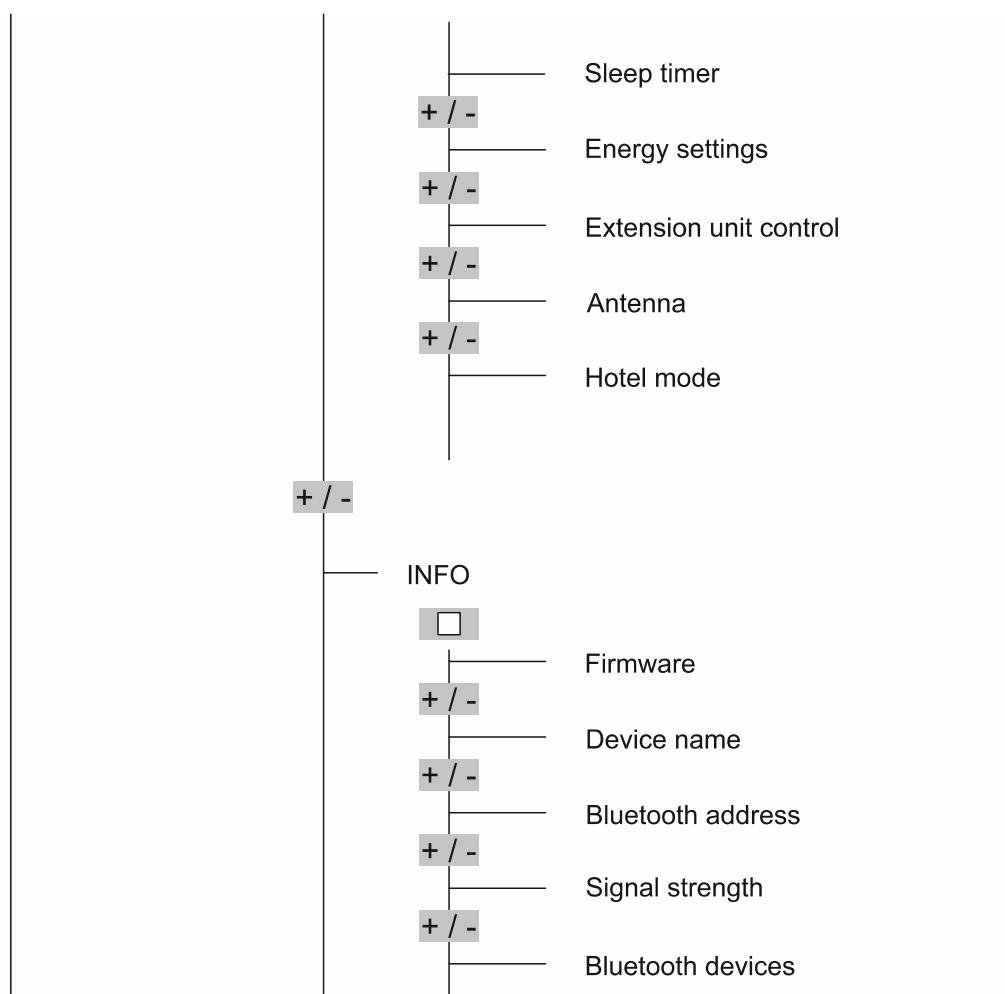

10 Case studies

10.1 Installation set

A smaller room is to be equipped with a flush-mounted radio and a single flush-mounted loudspeaker.

This is a classic case of application for a flush-mounted radio. For this application the flush-mounted radio together with a flush-mounted loudspeaker are available ready for installation.

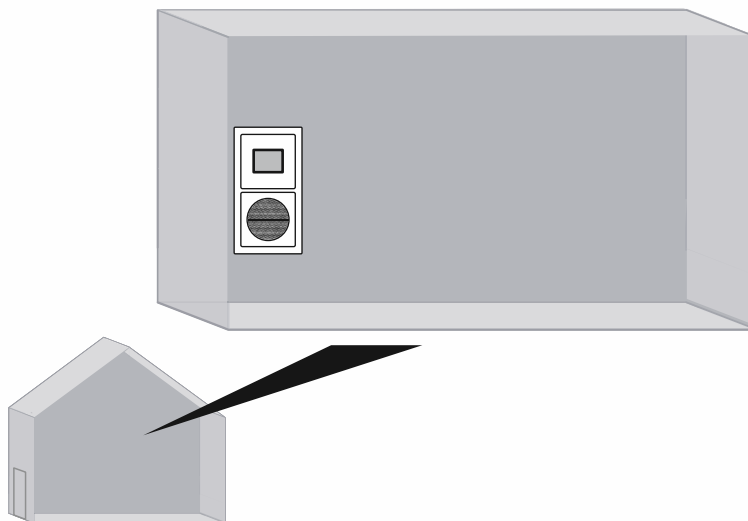
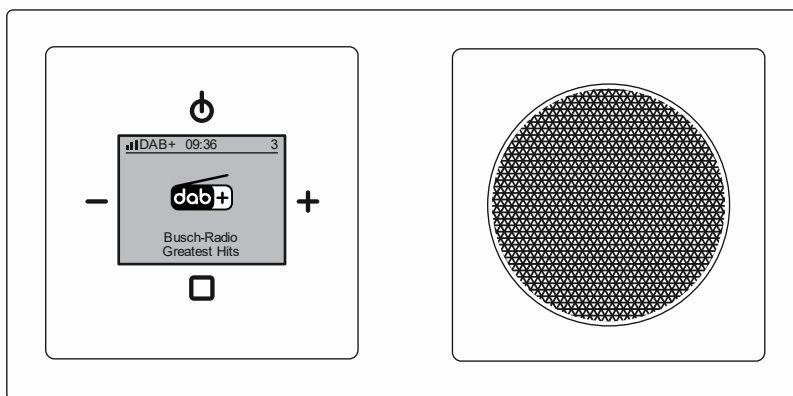

Fig. 78: Overview of installation set

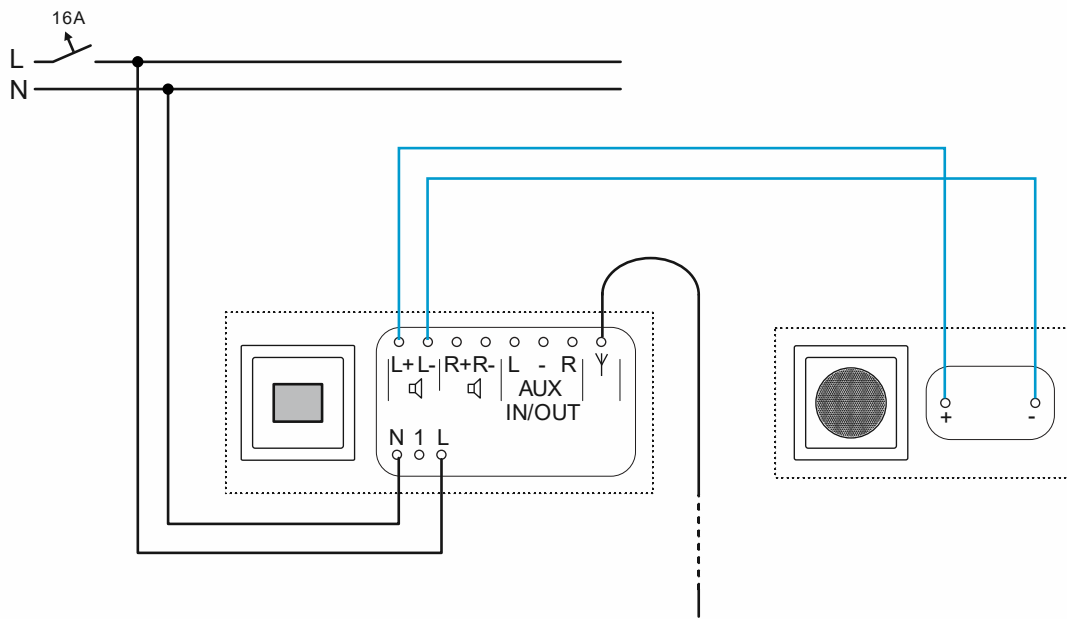

Fig. 79: Installation set connection (cable antenna, approx. 90 cm long)

10.2 Installation set and extension unit operation

A smaller room is to be equipped with a flush-mounted radio and a single flush-mounted loudspeaker. In addition to standard operation, the flush-mounted radio is to play music as soon as the light is switched on.

This is a classic case of application for a flush-mounted radio that is installed in a sanitary room without windows. For this application the flush-mounted radio together with a flush-mounted loudspeaker are available ready for installation. The switch or button must be obtained separately.

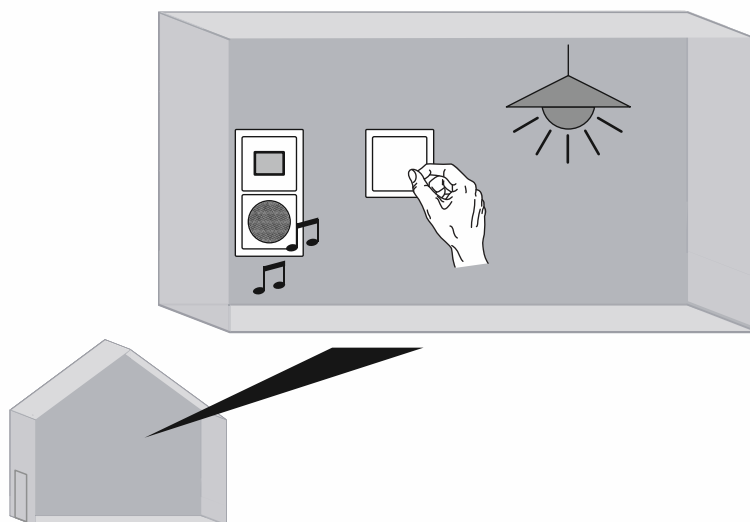
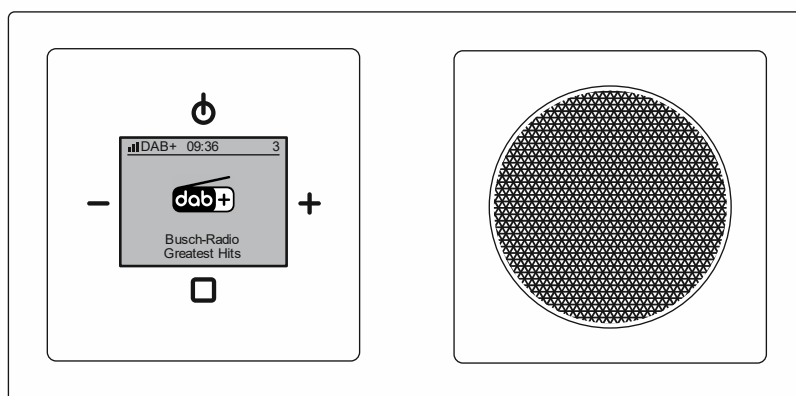

Fig. 80: Installation set with extension unit operation: Overview

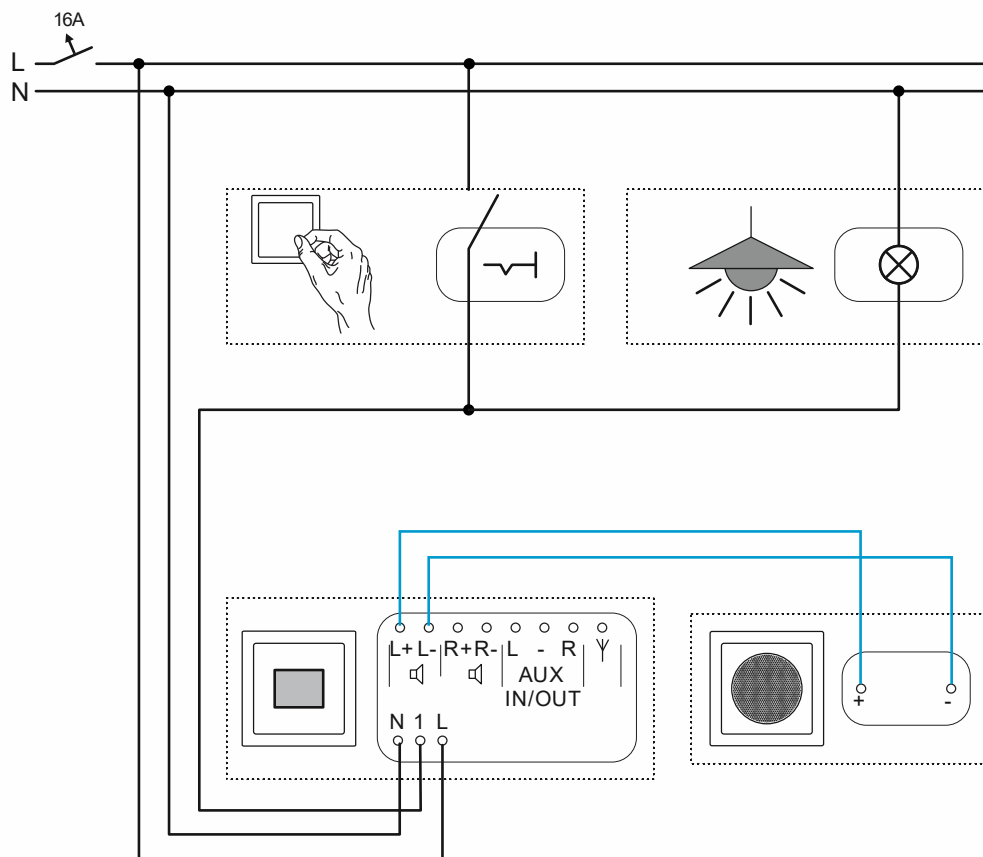

Fig. 81: Installation set with extension unit operation: Connection

10.3 Installation set and movement detectors

A smaller room is to be equipped with a flush-mounted radio and a single flush-mounted loudspeaker.

In addition to standard operation, the flush-mounted radio is to play music as soon as someone enters the room. This is implemented with a movement detector.

For this application the flush-mounted radio together with a flush-mounted loudspeaker are available ready for installation. The movement detector must be obtained separately.

In this example the combination of the "Busch-Watchdog 180 flex, Basic sensor with select lens 64761-xxx" and flush-mounted insert "Busch-flexTronics® Relay insert flex, 1 gang 64811 U" is used. This combination is ideally suited for this example.

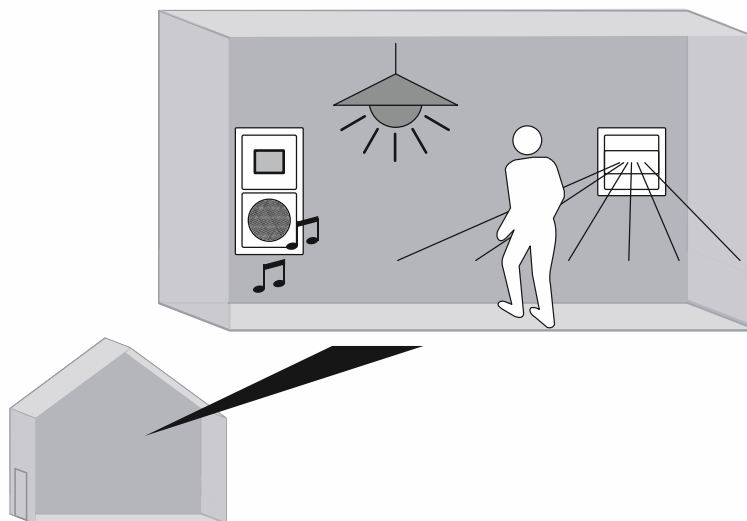
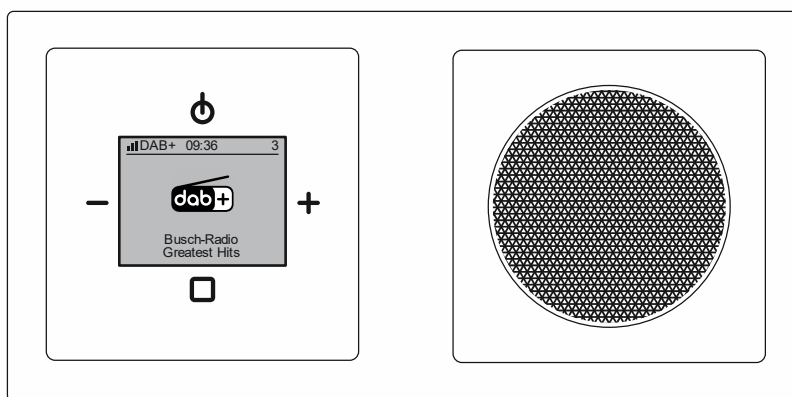

Fig. 82: Installation set and movement detector: Overview

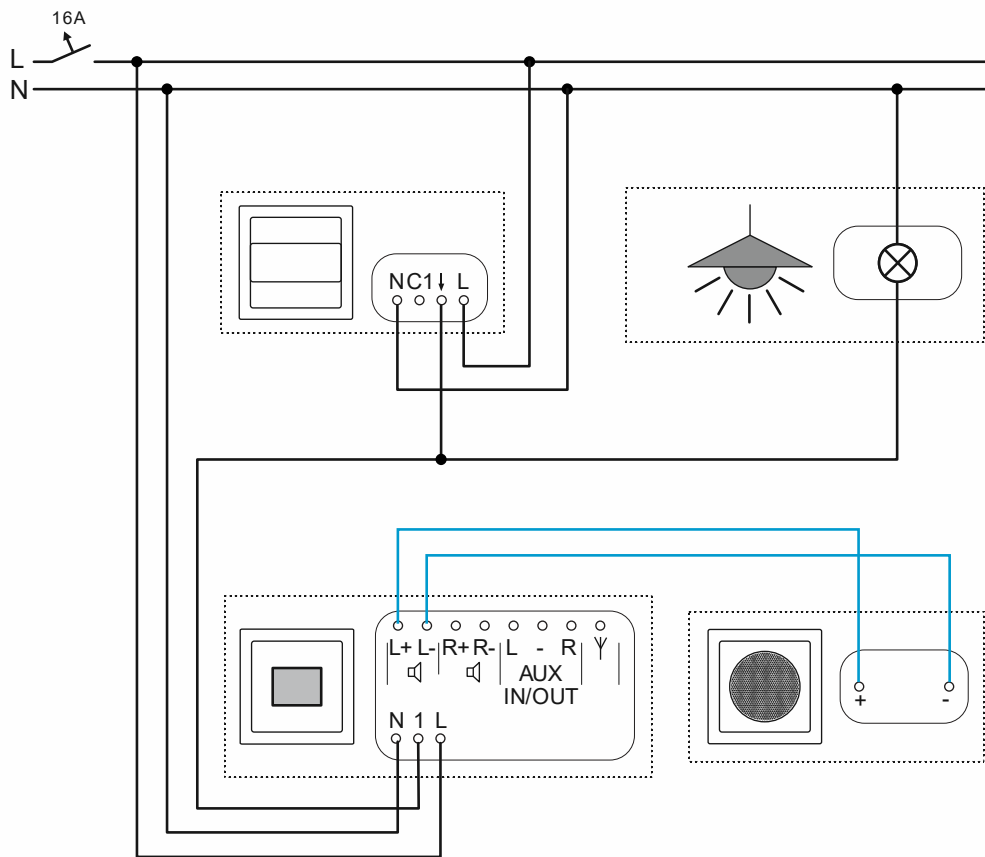

Fig. 83: Installation set and movement detector: Connection

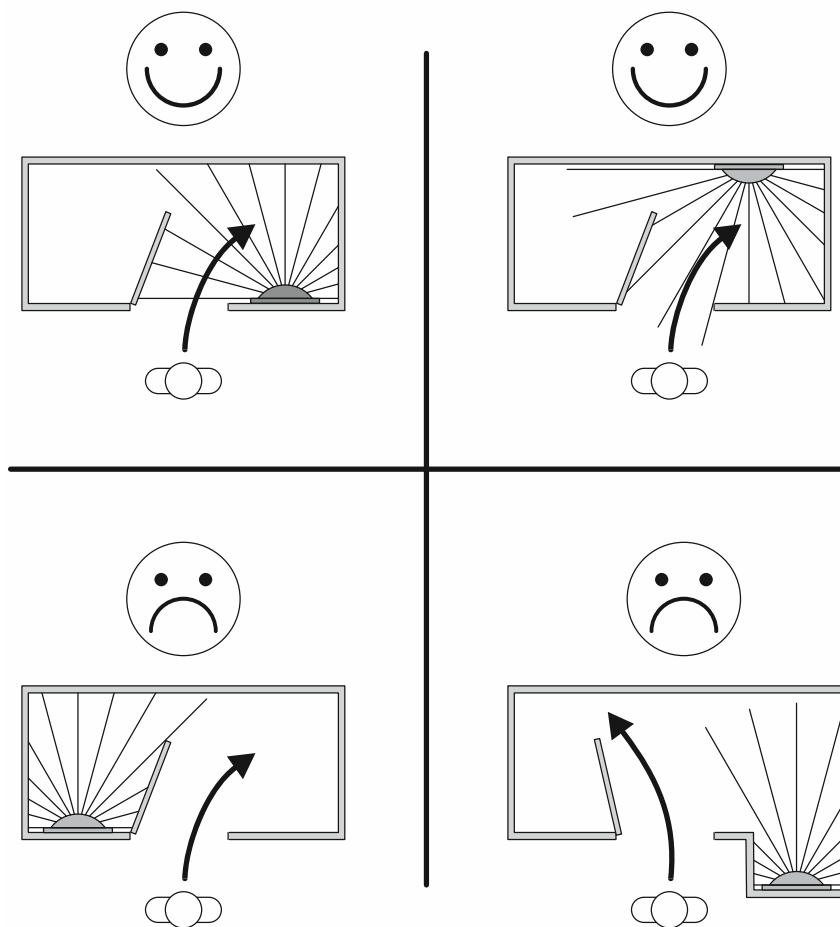

Fig. 84: Examples of optimal and unfavourable positioning of the movement detector (position at the radio)

A movement detector is normally positioned at an optimum position in the room. If the flush-mounted radio is located at a position that is optimal for the movement detector, the movement detector can also be positioned directly near the flush-mounted radio.

- Advantage: In case of retrofitting, no new cables need to be laid in the room.
- Disadvantage: If the flush-mounted radio is positioned unfavourable for a movement detector, this can lead to limitations up to the complete loss of movement detection.

The movement detector can naturally not look through walls, opened doors or other objects. The movement detector must be positioned in such a way that the detection range is not unfavourably covered.

10.4 Ceiling loudspeakers

A slightly larger room should be equipped with a flush-mounted radio and 2 ceiling loudspeakers.

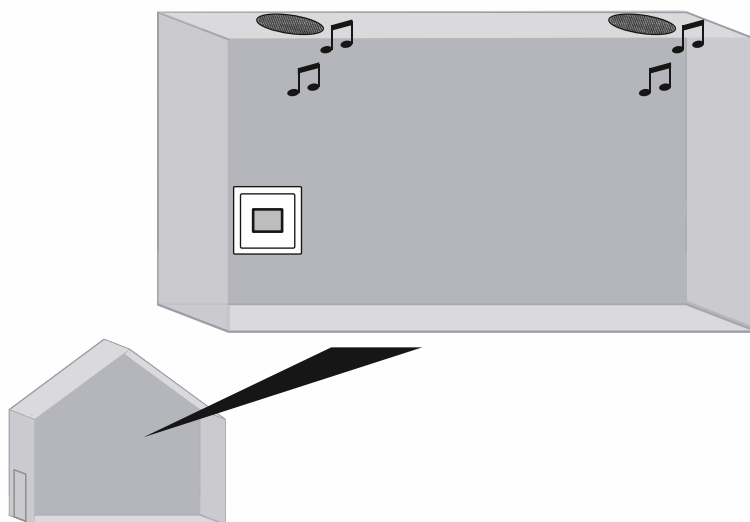

Fig. 85: Flush-mounted radio with 2 ceiling loudspeakers: Overview

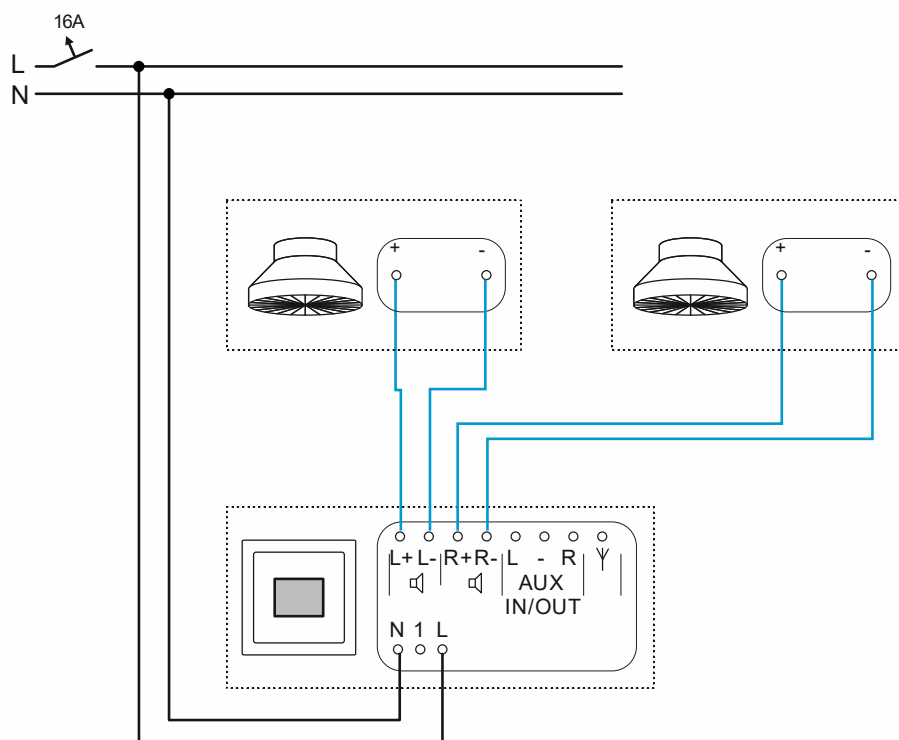

Fig. 86: Flush-mounted radio with 2 ceiling loudspeakers: Connection

10.5 Installation set and Bluetooth loudspeakers

A larger room is equipped with a flush-mounted radio and a single flush-mounted loudspeaker.

In addition to the flush-mounted loudspeaker, also a Bluetooth loudspeaker is set up which can play the music of the flush-mounted radio.

- So that the Bluetooth loudspeaker can play the music, the Bluetooth mode of the flush-mounted radio must be set on "Station" in the settings, see chapter 9.3.16 "Menu "Bluetooth" - "Mode"" on page 66.

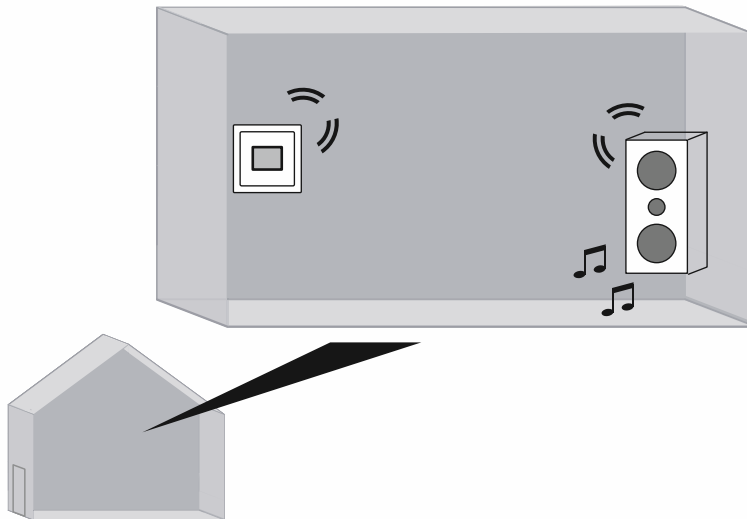

Fig. 87: Installation set plus Bluetooth loudspeaker: Overview

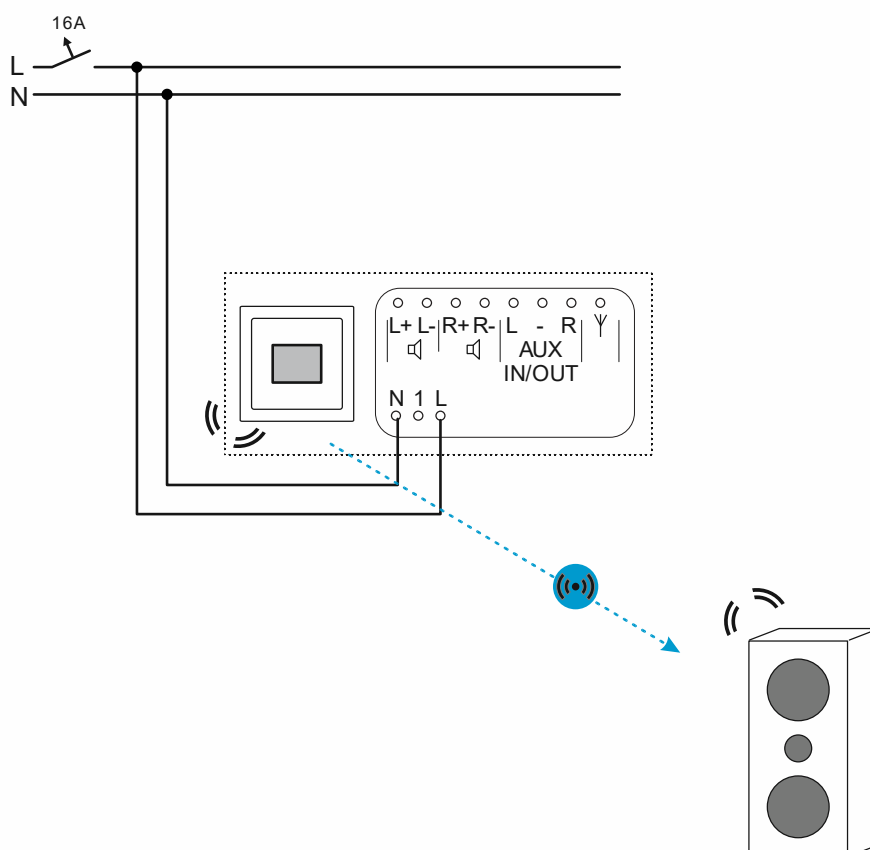

Fig. 88: Installation set plus Bluetooth loudspeaker: Connection



Notice

If additional loudspeakers are connected to the flush-mounted radio (Bluetooth mode "Station"), they are automatically deactivated as soon as the connection to the Bluetooth loudspeaker are established. Otherwise opposing interferences could result (e.g. echo effects).

10.6 AUX and amplifier

A larger room should be equipped with a flush-mounted radio and 2 ceiling loudspeakers.

To increase the performance of the flush-mounted radio, an amplifier is installed in a sub-distribution or in a suspended ceiling.

To allow the music to be played on the ceiling loudspeakers via the AUX connections, the AUX mode must be set on "Output" in the characteristics of the flush-mounted radio, see chapter 9.3.26 "Menu "Settings" - "AUX"" on page 78.

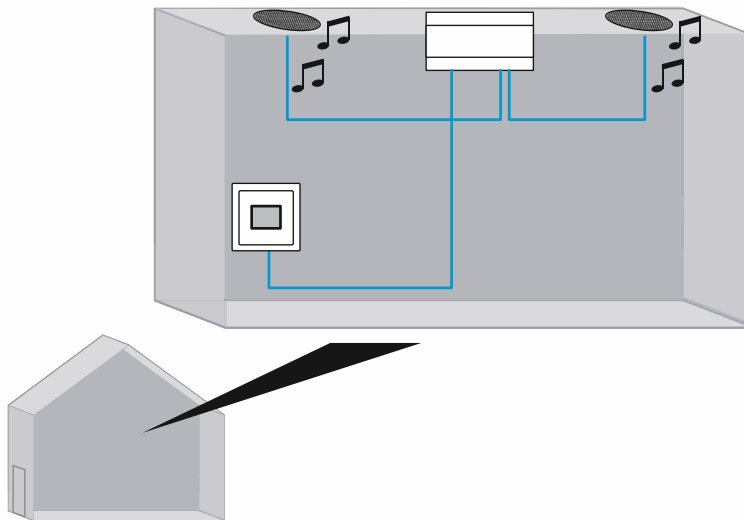

Fig. 89: Flush-mounted radio with amplifier and 2 ceiling loudspeakers: Overview



Notice

Busch-Jaeger does not currently offer a corresponding amplifier. For this application the products of third party manufacturers need to be obtained.

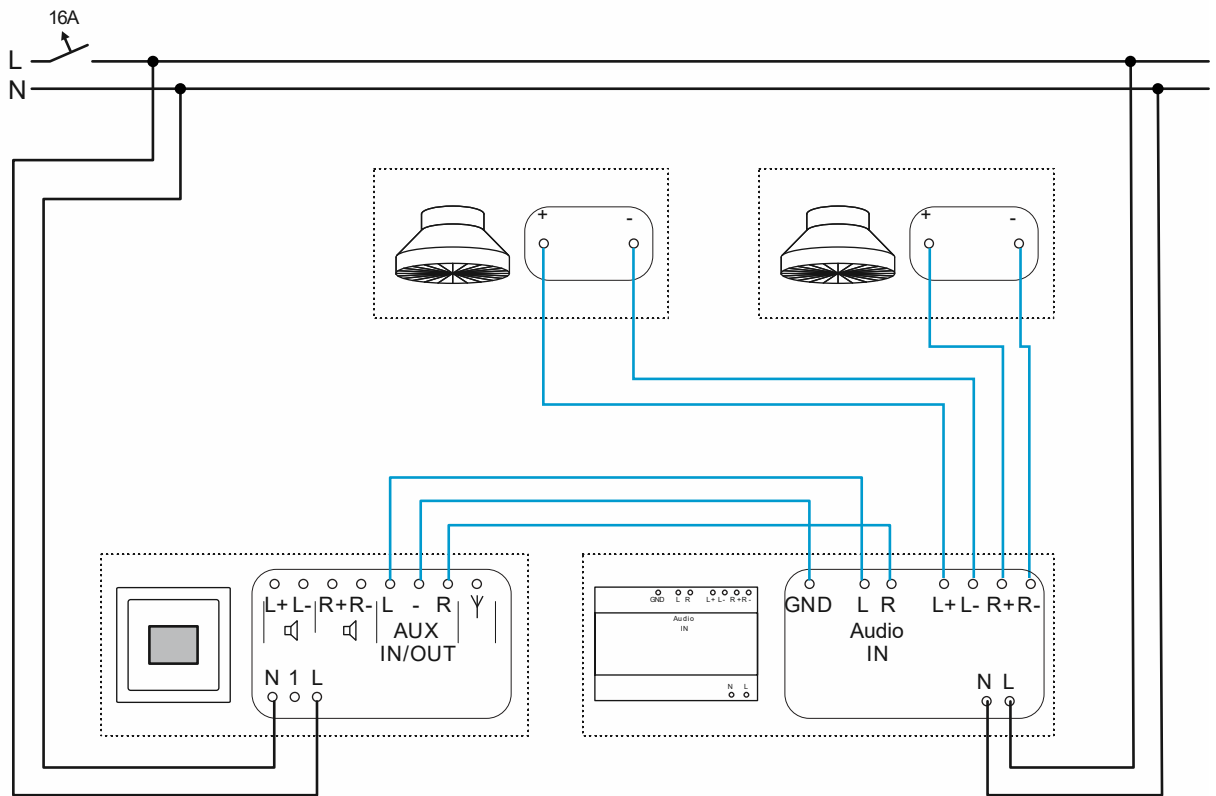

Fig. 90: Flush-mounted radio with amplifier and 2 ceiling loudspeakers: Connection

The connection distribution and designation of the amplifier depends on the device used. For the designation "AUX-IN" the designation "Audio-IN" or "Line-IN" is also commonly used.

10.7 AUX and HiFi system

In a room, the stations of the flush-mounted radio should be able to be additionally played via a HiFi system.

For this the flush-mounted radio is extended by a multimedia adapter with 2 cinch-jacks.

To allow the music to be played via the AUX connections on the HiFi system, the AUX mode must be set on "Output" in the characteristics of the flush-mounted radio, see chapter 9.3.26 "Menu "Settings" - "AUX"" on page 78.

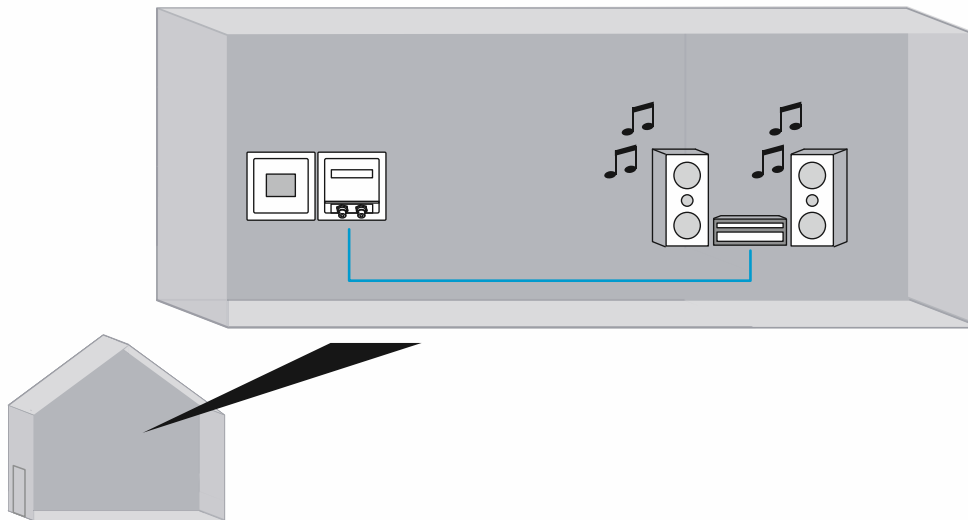

Fig. 91: Flush-mounted radio with HiFi system: Overview

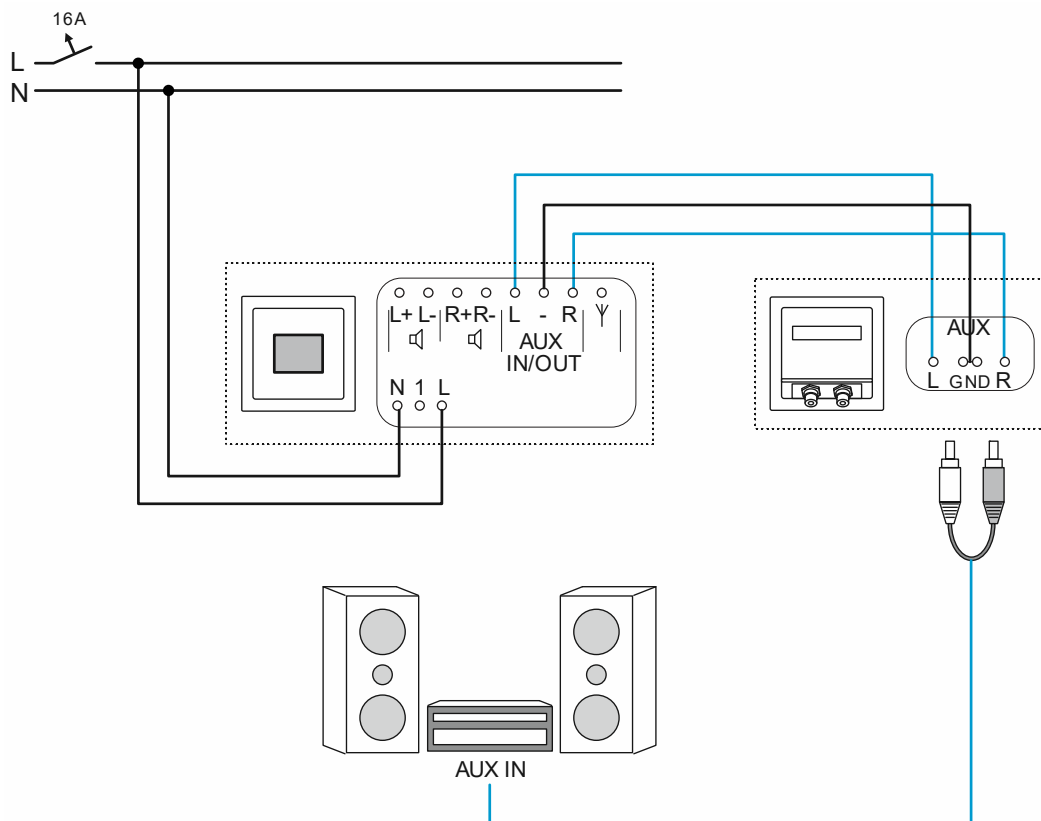

Fig. 92: Flush-mounted radio with HiFi system: Connection

The connection distribution and designation of the HiFi system depends on the device used. For the designation "AUX-IN" the designation "Audio-IN", "Line-IN", "CD" or "Tuner" are also commonly used.

10.8 Playing the multimedia device via the flush-mounted radio on the HiFi system

In a room, the playlist of a smartphone is to be played via the flush-mounted radio on a HiFi system.

For this the flush-mounted radio is extended by a multimedia adapter with 2 cinch-jacks.

To allow the music to be played via the AUX connections on the HiFi system, the AUX mode must be set on "Output" in the characteristics of the flush-mounted radio, see chapter 9.3.26 "Menu "Settings" - "AUX"" on page 78.

To allow the flush-mounted radio to receive the playlist of the smartphone via Bluetooth®, the Bluetooth mode must be set in the characteristics of the flush-mounted radio on "Receiver", see chapter 9.3.16 "Menu "Bluetooth" - "Mode"" on page 66.

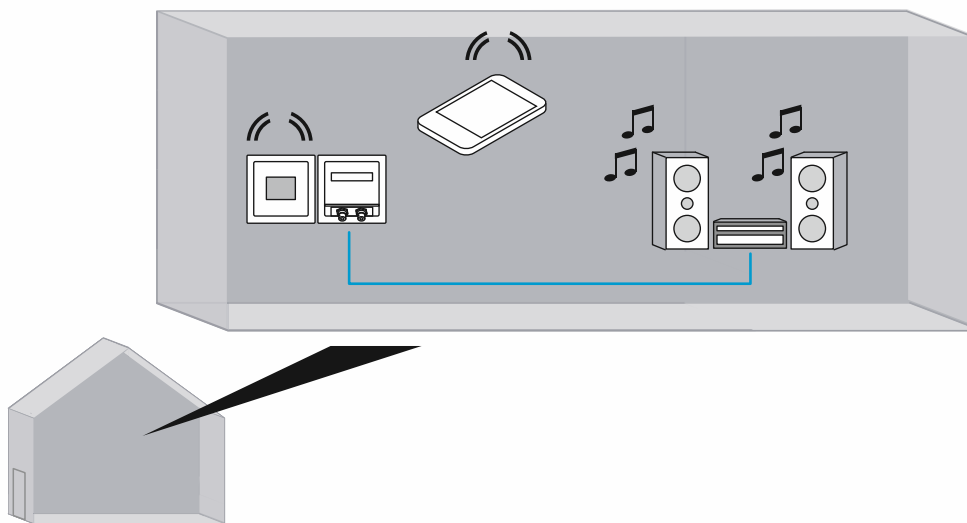

Fig. 93: Playlist of a smartphone via flush-mounted radio on HiFi system: Overview

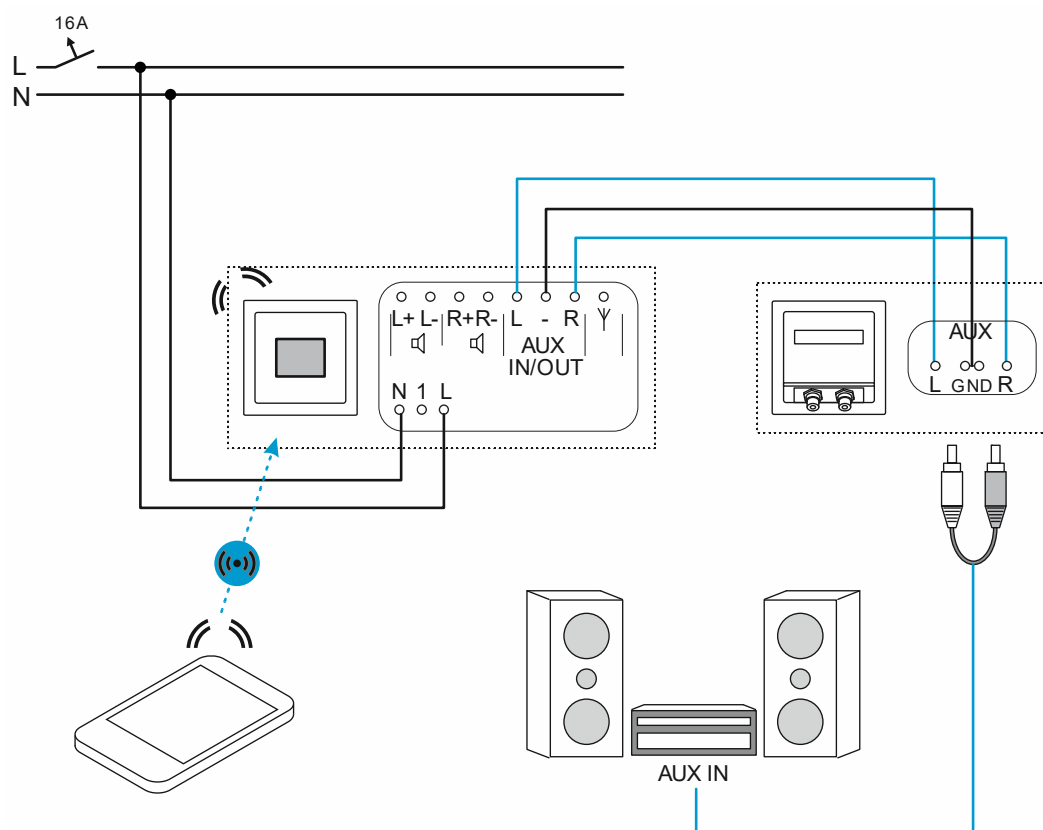

Fig. 94: Playlist of a smartphone via flush-mounted radio on HiFi system: Connection

The connection distribution and designation of the HiFi system depends on the device used. For the designation "AUX-IN" the designation "Audio-IN", "Line-IN", "CD" or "Tuner" are also commonly used.

10.9 AUX and TV audio signals

In a room, the audio signals of the TV are to be heard via the flush-mounted radio. This also presents the option of listening to a news or music station on the flush-mounted radio.

For this the flush-mounted radio is extended by a multimedia adapter with 2 cinch-jacks.

To allow the TV audio signals to be played via the AUX connections of the flush-mounted radio, the AUX mode must be set on "Input" in the characteristics of the flush-mounted radio, see chapter 9.3.26 "Menu "Settings" - "AUX"" on page 78.

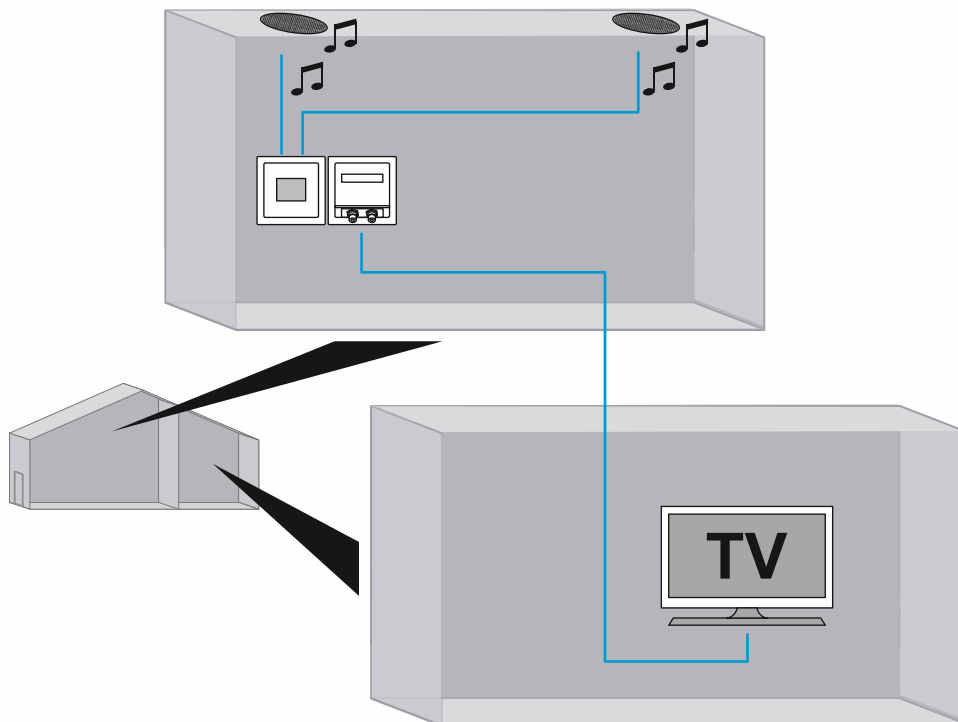

Fig. 95: Flush-mounted radio with TV: Overview

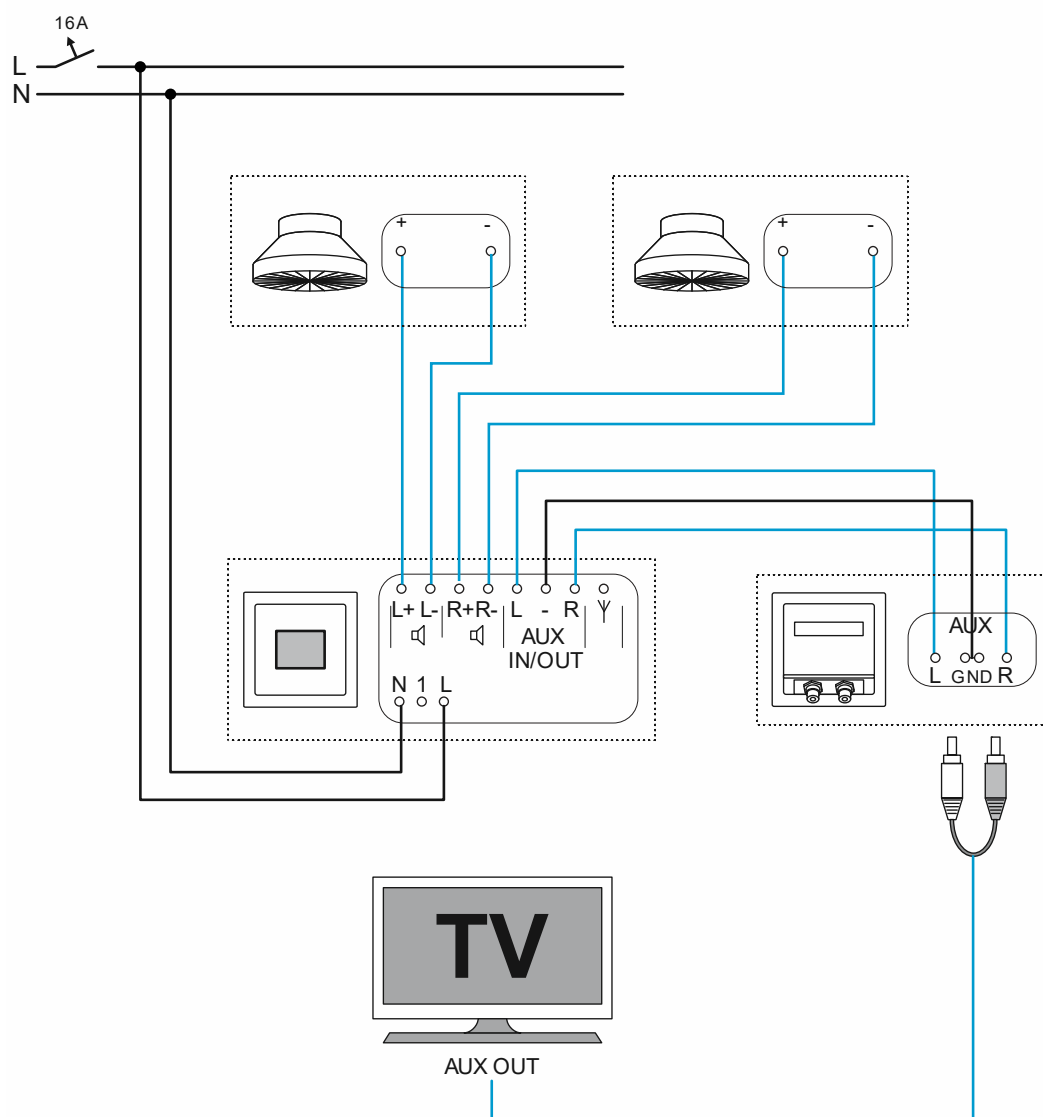

Fig. 96: Flush-mounted radio with TV: Connection

The connection distribution and designation of the TV depends on the device used. For the designation "AUX-OUT" the designation "Audio-OUT" or "Line-OUT" is also commonly used.

11 Maintenance

11.1 Cleaning

**Caution! - Risk of damaging the device!**

- When spraying on cleaning agents, these can enter the device through crevices.
 - Do not spray cleaning agents directly onto the device.
- Aggressive cleaning agents can damage the surface of the device.
 - Never use caustic agents, abrasive agents or solvents.

Clean dirty devices with a soft dry cloth.

- If this is insufficient, the cloth can be moistened slightly with a soap solution.

12 FAQ and tips

Bad quality of reception

If no stations are found during a search or the message "No reception" is frequently displayed when playing favourites, this can have several causes.

- No external antenna is connected to the device:
 - The device is equipped with an internal antenna. This is sufficient when the reception is of high quality. However, if the reception is bad, an external antenna is recommended, such as a cable antenna. For the connection of an external antenna, see chapter 7.5.3 "Antenna" on page 25.
- An external antenna is connected. The antenna mode is set on "Internal" in the device.
 - In this case the external antenna is not used by the device. Set the antenna mode of the device on "External", see chapter 9.3.34 "Menu "Settings" - "Antenna"" on page 86.
- No external antenna is connected. The internal antenna is being used. The antenna mode is set on "External" in the device.
 - In this case the internal antenna is not used by the device. Set the antenna mode of the device on "Internal", see chapter 9.3.34 "Menu "Settings" - "Antenna"" on page 86.
- The external antenna is not ideally positioned.
 - The position of the external antenna can have a decisive effect on the quality of the reception. The optimum position of the external antenna can only be determined locally by means of testing. Keep changing the position of the external antenna until the reception is of the right quality.
- The device is at a location where there is no reception.
 - In this case an external antenna must be connected in an area that is located where there is reception. For the connection of an external antenna, see chapter 7.5.3 "Antenna" on page 25.

The volume cannot be adjusted fully.

- The maximum volume of the flush-mounted radio is adjusted down. During normal operation the volume bar can then not be adjusted completely to the right.
 - For adjusting the maximum volume of the flush-mounted radio, see chapter 9.3.25 "Menu "Settings - "Maximum volume"" on page 77.

The alarm signal is low

- The maximum volume of the flush-mounted radio is adjusted down. This also limits the the volume of the alarm signal.
 - For adjusting the maximum volume of the flush-mounted radio, see chapter 9.3.25 "Menu "Settings - "Maximum volume"" on page 77.

The time cannot be set

- The time in connection with a radio station is set automatically.
 - If the flush-mounted radio is permanently connected with favourite "AUX", the time is not updated. Then to set the time, switch to the favourites of a radio station and back again after a brief moment.

Favourite "AUX" is not visible

- The AUX mode in the device is set on "AUX output" or deactivated.
 - To set the AUX mode of the device on "AUX input", see chapter 9.3.26 "Menu "Settings" - "AUX"" on page 78.

Favourite "Bluetooth" is not visible

- The Bluetooth mode in the device is set on "Station".
 - To set the Bluetooth mode of the device on "Receiver", see chapter 9.3.16 "Menu "Bluetooth" - "Mode"" on page 66.

Nothing can be heard on the flush-mounted radio.

If the Bluetooth icon is permanently displayed on the flush-mounted radio, the multimedia device is connected.

- The multimedia device is currently switched off (time out not yet reached).
- The mute function on the multimedia device has been activated.
- The volume on the multimedia device has been turned down to "Zero".
- The player software of the multimedia device in pause mode.
 - This could be the case especially after the connection has been temporarily disrupted.
- You are at the boundary of the transmission range. While the signal is still strong enough to maintain the connection, it is too weak to transmit sufficient data for playing music.

The multimedia device cannot be connected, even though the flush-mounted radio is displayed in the Bluetooth settings.

- A different multimedia device is already connected to the flush-mounted radio.
 - Disconnect and uncouple the connected multimedia device in the flush-mounted radio.
 - see chapter 9.3.19 "Menu "Bluetooth" – "Disconnect active device"" on page 69
 - see chapter 9.3.20 "Menu "Bluetooth" – "Uncoupling all devices"" on page 70

You must then couple and connect your multimedia device again because the list of coupled devices stored in the flush-mounted radio has been deleted.

13 Declaration of conformity

Busch-Jaeger herewith declares, that radio system type 8217 U-101 conforms to directive 2014/53/EU.

The complete text of the EU Declaration of Conformity is available at the following Internet address:

8217 U-101	https://www.busch-jaeger-katalog.de/2CKA008200A0278,artikel.html
------------	---

Table 24: Link to Declaration of Conformity

14 Index

A	
Adjusting the volume	32
Alarm clock	34, 35, 51, 53
Alarm profiles	34, 54, 55
Alarm times	34, 54, 55
Antenna	16, 20, 25, 86, 114
Automatic search mode DAB+	26, 27, 33, 38, 59, 61
Automatic search mode FM	26, 27, 33, 38, 60, 62
AUX	20, 23, 26, 46, 47, 78, 105, 107, 109, 111, 115
AUX (Auxiliary)	16, 23, 46
AUX and amplifier	105
AUX and TV audio signals	111
AUX input gain	46, 79
B	
Bass	74
Bluetooth loudspeakers	103
Bluetooth mode	39, 41, 42, 43, 51, 66, 67, 68, 103, 109, 115
Button assignment	31, 50
C	
Cleaning	113
Commissioning	26, 91
Configuration	29, 49, 51
Connect Bluetooth device	39, 41, 42, 67
Connection, installation / mounting	14
Couple Bluetooth device	39, 41, 42, 67, 68
D	
Deactivate alarm days	54, 57
Deactivate days	54, 57
Delete favourites	38, 59, 60, 63, 65
Device information	52, 89
Disconnect Bluetooth device	42, 45, 69, 115
dismantling	15
Display	49
Display brightness	81, 82, 84
Display favourite stations	38
Display favourites	38
Display profile	80
Display station list DAB+	38, 51, 59, 61
Display station list FM	38, 60, 62
E	
Electrical connection	16, 17, 20
Energy efficiency	84
Environment	10
Example of application of AUX and amplifier	105
Example of application of AUX and HiFi system	107
Example of application of ceiling loudspeakers	102
Example of application of installation set	95
Example of application of installation set and Bluetooth loudspeakers	103
Example of application of installation set and extension unit operation	97
Example of application of installation set and movement detector	99
Example of application of playing the multimedia device on the HiFi system	109
Extension unit operation	85, 97
F	
Failure of the electric voltage	48
FAQ and tips	114
Favourites	32
Foreign language is set	72
Functions	11
Functions - Configuration	51
H	
HiFi system	107, 109
Hotel mode	87
I	
Improper use	7
Information about Bluetooth operation	43
Information and symbols used	6
Information on protection of the environment	10
Input gain	46, 79
Intended use	7
L	
Language	26, 52, 71
Loudspeaker	12, 16, 21
Low	74
M	
Maintenance	113
Maximum volume	34, 77, 114
Menu "Info"	52, 89
Menu tree	52, 92
Mounting	15
Move favourites	38, 59, 60, 63, 64
Movement detectors	99
Multimedia connection	21
N	
Normal operation	28, 30
Notes on the instruction manual	5
O	
Operating alarm clock	34
Operating AUX	23, 46
Operating Bluetooth®	22, 33, 39
Operating modes	28
Operation	8, 28
Operation - Configuration	29, 49
Overview	30
P	
Possible combinations	12
Profile	80
Q	
Qualification of personnel	8

Quality of reception.....	114	Snooze function	34
R		Specifying signal tones	34, 58
Recommended behaviour	9	Start volume	76
Rectification of problems for your Bluetooth operation	43	Stored data	9
Requirements for the electrician	14	Switch-off time	37, 83
RESET	26, 91	T	
Resetting the device	26, 91	Target group	8
Restore language	72	Technical data.....	13
S		The local language.....	72
Safety	6, 14	Times	34, 54, 55
Safety instructions	9	Trademarks	5
Save favourite stations	38	Treble	75
Save favourites.....	38, 51, 59, 60, 61, 62	turn-off time.....	31, 37, 83
Selecting the station (Favourites)	32	U	
Set FM stations manually	26, 27, 33, 38, 63	Uncoupling Bluetooth devices.....	42, 45, 70, 115
Setup and function.....	11	V	
Signal tones.....	34, 58	Voltage failure	48
Sleep function.....	31, 37, 83	Volume	34, 77, 114
Sleep timer	37, 83		
Snooze	34		

Busch-Jaeger Elektro GmbH
A member of the ABB Group

Freisenbergstraße 2
58513 Lüdenscheid

www.BUSCH-JAEGER.de
info.bje@de.abb.com

Central sales service:
Tel.: +49 2351 956-1600
Fax: +49 2351 956-1700