

# Protective Devices

## Residual Current Devices

### PFIM-X

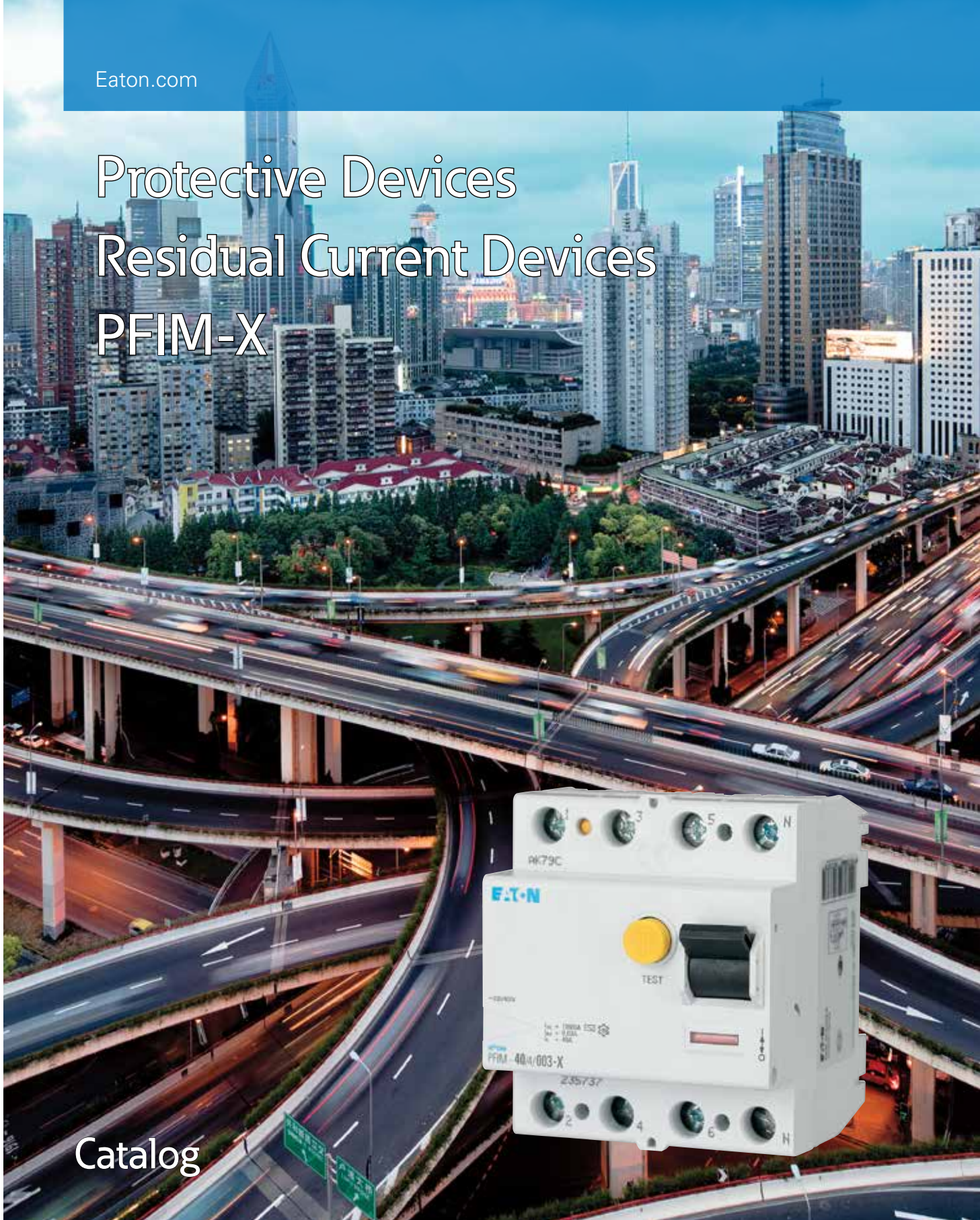





Catalog





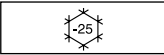

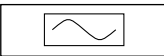

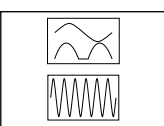
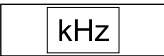
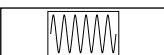
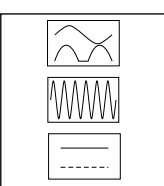
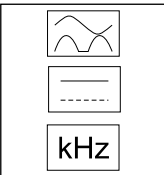
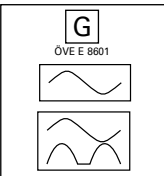
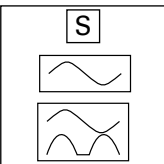















*Powering Business Worldwide*

## Residual Current Devices - General Data

### Short description of the most important RCD types

| Symbol  | Description   |
|---|---|
|    | Eaton standard. Suitable for outdoor installation (distribution boxes for outdoor installation and building sites) up to -25° C.  |
|    | Conditionally surge-current proof (>250 A, 8/20 μs) for general application.  |
|    | Type AC: AC current sensitive RCCB  |
|    | Type A: AC and pulsating DC current sensitive RCCB, not affected by smooth DC fault currents up to 6 mA   |
|    | Type F: AC and pulsating DC current sensitive RCCB, trips also at frequency mixtures (10 Hz, 50 Hz, 1000 Hz), min. 10 ms time-delayed, min. 3 kA surge current proof, higher load capacity with smooth DC fault currents up to 10 mA  |
|    | Frequency range up to 20 kHz  |
|  | Trips also at frequency mixtures (10 Hz, 50 Hz, 1000 Hz)  |
|  | Type B: All-current sensitive RCD switchgear for applications where DC fault currents may occur. Non-selective, non-delayed. Protection against all kinds of fault currents.  |
|  | Type B+: All-current sensitive RCD switchgear for applications where DC fault currents may occur. Non-selective, non-delayed. Protection against all kinds of fault currents. Provides enhanced fire safety.  |
|  | RCD of type G (min 10 ms time delay) surge current-proof up to 3 kA. For system components where protection against unwanted tripping is needed to avoid personal injury and damage to property. Also for systems involving long lines with high capacitive reactance. Some versions are sensitive to pulsating DC. Some versions are available in all-current sensitive design.  |
|  | RCD of type S (selective, min 40 ms time delay) surge current-proof up to 5 kA. Mainly used as main switch, as well as in combination with surge arresters. This is the only RCD suitable for series connection with other types if the rated tripping current of the downstream RCD does not exceed one third of the rated tripping current of the device of type S. Some versions are sensitive to pulsating DC. Some versions are available in all-current sensitive design. |

### Kind of residual current and correct use of RCD Types

| Kind of current  | Current profile   | Correct use / application field of RCCB types                                     |   |   |   |   |   | Tripping current |
|--|---|---|---|---|---|---|---|------------------|
|  |   | AC  | A   | F   | B   | / B+  |   |                  |
| Sinusoidal AC residual current                                 |  |  |  |  |  |  | 0.5 to 1.0 $I_{\Delta n}$   |                  |
| Pulsating DC residual current (positive or negative half-wave) |  | -   |  |  |  |   | 0.35 to 1.4 $I_{\Delta n}$  |                  |
| Cut half-wave current  |  | -   |  |  |  |   | Lead angle 90°:<br>0.25 to 1.4 $I_{\Delta n}$<br>Lead angle 135°:<br>0.11 to 1.4 $I_{\Delta n}$ |                  |
| Half-wave with smooth DC current of 6 mA                       |  | -   |  |  |  |   | max. 1.4 $I_{\Delta n}$ + 6 mA  |                  |
| Half-wave with smooth DC current of 10 mA                      |  | -   | -   |  |  |   | max. 1.4 $I_{\Delta n}$ + 10 mA   |                  |
| Smooth DC current  |  | -   | -   | -   |  |   | 0.5 to 2.0 $I_{\Delta n}$   |                  |

### Tripping time

#### Break time and non-actuating time for alternating residual currents (r.m.s. values) for type AC and A RCCB

| Classification  | $I_{\Delta n}$ mA |  | $I_{\Delta n}$ | 2 x $I_{\Delta n}$ | 5 x $I_{\Delta n}$ | 5 x $I_{\Delta n}$ or 0.25A | 500A         |
|---|-------------------|--|----------------|--------------------|--------------------|-----------------------------|--------------|
| Standard RCD<br>Conditionally surge current-proof 250 A       | ≤30               | Max. tripping time (s)                               | 0.3            | 0,15               |                    | 0,04                        | 0.04         |
| Standard RCD<br>Conditionally surge current-proof 250 A       | >30               | Max. tripping time (s)                               | 0.3            | 0.15               | 0.04               |                             | 0.04         |
| RCCB Type G<br>(Short-time-delay)<br>Surge current-proof 3 kA | 30                | Min. non actuating time(s)<br>Max. tripping time (s) | 0.01<br>0.3    | 0.01<br>0.15       |                    | 0.01<br>0.04                | 0.01<br>0.04 |
| RCCB Type G<br>(Short-time-delay)<br>Surge current-proof 3 kA | >30               | Min. non actuating time(s)<br>Max. tripping time (s) | 0.01<br>0.3    | 0.01<br>0.15       | 0.01<br>0.04       |                             | 0.01<br>0.04 |
| RCCB Type S (Selective)<br>Surge current-proof 5 kA           | >30               | Min. non actuating time(s)<br>Max. tripping time (s) | 0.13<br>0.5    | 0.06<br>0.2        | 0.05<br>0.15       |                             | 0.04<br>0.15 |

#### Break time for half-wave pulsating residual currents (r.m.s. values) for type A RCCB

| Classification  | $I_{\Delta n}$ mA |                        | 1.4 x $I_{\Delta n}$ | 2 x $I_{\Delta n}$ | 2.8 x $I_{\Delta n}$ | 4 x $I_{\Delta n}$ | 7 x $I_{\Delta n}$ | 0.35 A | 0.5 A | 350A |
|---|-------------------|------------------------|----------------------|--------------------|----------------------|--------------------|--------------------|--------|-------|------|
| Standard RCD<br>Conditionally surge current-proof 250 A       | <30               | Max. tripping time (s) |                      | 0.3                |                      | 0.15               |                    |        | 0.04  | 0.04 |
| Standard RCD<br>Conditionally surge current-proof 250 A       | 30                | Max. tripping time (s) | 0.3                  |                    | 0.15                 |                    |                    | 0.04   |       | 0.04 |
| Standard RCD<br>Conditionally surge current-proof 250 A       | >30               | Max. tripping time (s) | 0.3                  |                    | 0.15                 |                    | 0.04               |        |       | 0.04 |
| RCCB Type G<br>(Short-time-delay)<br>Surge current-proof 3 kA | 30                | Max. tripping time (s) | 0.3                  |                    | 0.15                 |                    |                    | 0.04   |       | 0.04 |
| RCCB Type G<br>(Short-time-delay)<br>Surge current-proof 3 kA | >30               | Max. tripping time (s) | 0.3                  |                    | 0.15                 |                    | 0.04               |        |       | 0.04 |
| RCCB Type S (Selective)<br>Surge current-proof 5 kA           | >30               | Max. tripping time (s) | 0.5                  |                    | 0.2                  |                    | 0.15               |        |       | 0.15 |

**Tripping Characteristics (IEC/EN 61008)**

**Tripping characteristics, tripping time range and selectivity of instantaneous, surge current-proof „G” and surge current-proof - selective „S” residual current devices.**

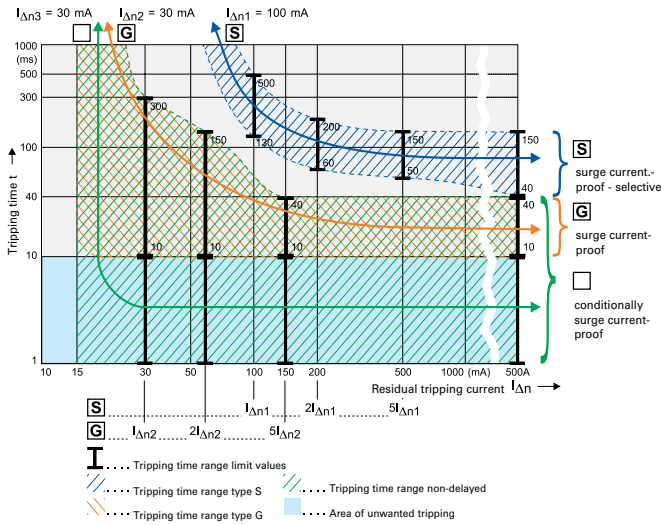

**IEC 60364-4-41** deals with additional protection: The use of RCDs with a rated residual operating current not exceeding 30 mA, is recognized in a.c. systems as additional protection in the event of failure of the provision for basic protection and/or the provision for fault protection or carelessness by users.

**This means when using RCDs for fault current/residual current protection two RCDs must be connected in series.**

**Testing:**

RCDs with tripping time delay (Types -G and -S) may be function tested with conventional testing equipment which must be set according to the instructions for operation of the testing device. Due to reasons inherent in the measuring process, the tripping time determined in this way may be longer than expected in accordance with the specifications of the manufacturer of the measuring instrument.

However, the device is ok if the result of measurement is within the time range specified by the manufacturer of the measuring instrument.

# 1.4

## Protective Devices

General

### Applications with frequency converters:

Due to the currents flowing off through the filters (designated IF), the sum of currents through the RCD is not exactly zero, which causes unwanted tripping.

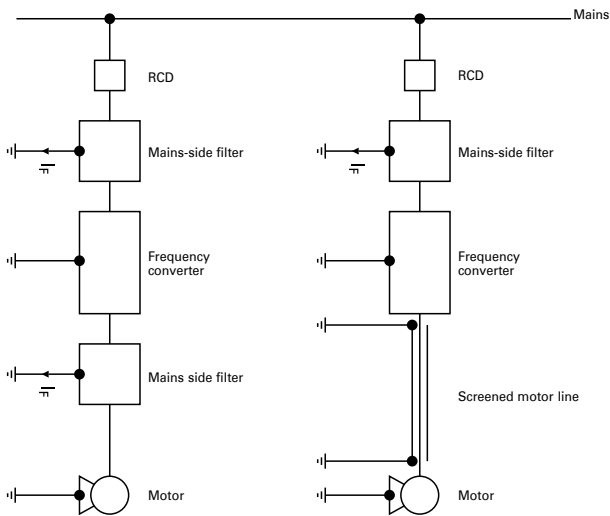

Frequency converters are used in a wide variety of systems and equipment requiring variable speed, such as lifts, escalators, conveyor belts, and large washing machines. Using them for such purposes in circuits with conventional residual current devices causes frequent problems with unwanted tripping.

The technical root cause of this phenomenon is the following: Fast switching operations involving high voltages cause high interference levels which propagate through the lines on the one hand, and in the form of interfering radiation on the other. In order to eliminate this problem, a mains-side filter (also referred to as input filter or EMC-filter) is connected between the RCD and frequency converter. The anti-interference capacitors in the filters produce discharge currents against earth which may cause unwanted tripping of the RCD due to the apparent residual currents. Connecting a filter on the output side between frequency converter and 3-phase AC motor results in the same behaviour.

### Tripping characteristic

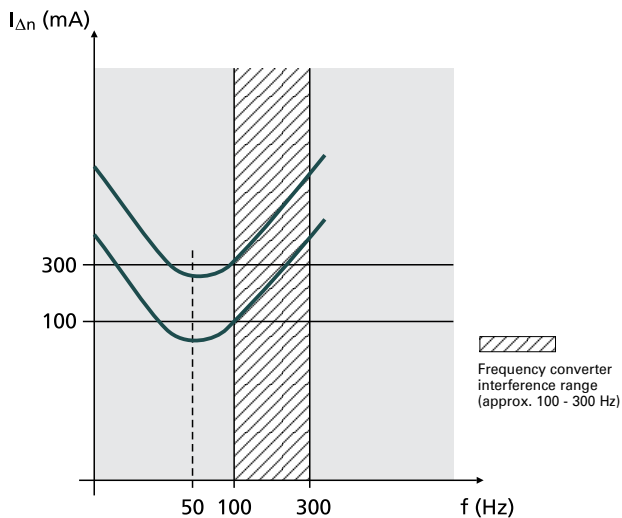

This sample tripping characteristic of a 100 mA RCD and a 300 mA RCD shows the following: In the frequency range around 50 Hz, the RCDs trip as required (50 - 100 % of the indicated  $I_{\Delta n}$ ). In the range shown hatched in the diagram, i. e. from approx. 100 to 300 Hz, unwanted tripping occurs frequently due to the use of frequency converters. Type F RCCBs are designed to reliably sense higher frequency residual currents, which leads to an enormous increase in the reliability and availability of electrical systems.

### Therefore, we recommend to use RCDs designed for applications with frequency converter!

These special residual current devices can be recognised by an extension of the type designation („-F“). They meet the requirements of compatibility between RCDs and frequency converters with respect to unwanted tripping.

Eaton stands for highest availability of your system also in applications where frequency drives are used. Therefore a full suite of Type F RCCBs (mechanical and digital assisted) are available in all feasible ratings to assist you in your application needs.

Our RCDs of type „-F“ are characterized by:

- Improved capabilities of reliably sensing residual currents up to 1 kHz
- Improved capabilities of withstanding 10 mA DC offset
- 10 ms short time delay minimum (G/F)
- Surge current proofness of 3 kA (G/F) and 5 kA (S/F)

SG62011





## Description

- Special residual current devices
  - back up protection with nominal value possible (overload protection)
- For fault current/residual current protection and additional protection
- Comprehensive range of accessories
- Real contact position indicator
- Automatic re-setting possible
- Special U-types available

| $I_n/I_{\Delta n}$<br>(A) | Type<br>Designation | Article No. | Units per<br>package |
|---------------------------|---------------------|-------------|----------------------|
|---------------------------|---------------------|-------------|----------------------|

#### Type AC, type A

Conditionally surge current-proof 250 A, type AC , type A 

SG16611











#### 2-pole

|   |                 |        |      |
|---|-----------------|--------|------|
| 40/0.03  | PFIM-40/2/003-X | 110089 | 1/60 |
|---|-----------------|--------|------|

SG62011



#### 4-pole

|   |                  |        |      |
|---|------------------|--------|------|
| 40/0.03  | PFIM-40/4/003-X  | 235737 | 1/30 |
| 40/0.10  | PFIM-40/4/01-X   | 235738 | 1/30 |
| 63/0.03  | PFIM-63/4/003-X  | 274293 | 1/30 |
| 63/0.10  | PFIM-63/4/01-X   | 274296 | 1/30 |
| 40/0.03  | PFIM-40/4/003-XA | 235739 | 1/30 |
| 63/0.03  | PFIM-63/4/003-XA | 294163 | 1/30 |
| 63/0.10  | PFIM-63/4/01-XA  | 293304 | 1/30 |
| 63/0.30  | PFIM-63/4/03-XA  | 293305 | 1/30 |





#### Type G, type G/A

Surge current-proof 3 kA, type G (ÖVE E 8601), type G , type G/A 

SG62011



#### 4-pole

|   |                    |        |      |
|---|--------------------|--------|------|
| 40/0.03  | PFIM-40/4/003-XG   | 235742 | 1/30 |
| 40/0.10  | PFIM-40/4/01-XG    | 274292 | 1/30 |
| 63/0.10  | PFIM-63/4/01-XG    | 293306 | 1/30 |
| 40/0.03  | PFIM-40/4/003-XG/A | 235743 | 1/30 |
| 63/0.03  | PFIM-63/4/003-XG/A | 103016 | 1/30 |





#### Type S/A

Selective + surge current-proof 5 kA, sensitive to residual pulsating DC, type S/A 

SG62011



#### 4-pole

|   |                   |        |      |
|---|-------------------|--------|------|
| 40/0.10  | PFIM-40/4/01-XS/A | 235740 | 1/30 |
| 40/0.30  | PFIM-40/4/03-XS/A | 235741 | 1/30 |
| 63/0.10  | PFIM-63/4/01-XS/A | 274294 | 1/30 |
| 63/0.30  | PFIM-63/4/03-XS/A | 274295 | 1/30 |



#### Type U

Selective + surge current-proof 5 kA, frequency converter-proof, type U 

SG62011



#### 4-pole

|   |                 |        |      |
|---|-----------------|--------|------|
| 40/0.10  | PFIM-40/4/01-XU | 235748 | 1/30 |
| 40/0.30  | PFIM-40/4/03-XU | 235749 | 1/30 |

**Specifications | Residual Current Devices PFIM**

**Description**

- Residual Current Devices
- Shape compatible with and suitable for standard busbar connection to other devices of the P-series
- Twin-purpose terminal (lift/open-mouthed) above and below
- Busbar positioning optionally above or below
- Free terminal space despite installed busbar
- Universal tripping signal switch, also suitable for PLS., PKN., Z-A. can be mounted subsequently
- Auxiliary switch Z-HK can be mounted subsequently
- Contact position indicator red - green
- Delayed types suitable for being used with standard fluorescent tubes with or without electronical ballast (30mA-RCD: 30 units per phase conductor, 100mA-RCD: 90 units per phase conductor).  
Notes: Depending of the fluorescent lamp ballast manufacturer partly more possible. Symmetrical allocation of the fluorescent lamp ballasts on all phases favourably. Shifting references of the fluorescent lamp ballast manufacturer consider.
- The device functions irrespective of the position of installation
- Tripping is line voltage-independent. Consequently, the RCD is suitable for "fault current/residual current protection" and "additional protection" within the the meaning of the applicable installation rules
- Mains connection at either side
- The 4-pole device can also be used for 2- or 3-pole connection. See connection possibilities.
- The test key "T" must be pressed every 6 month. The system operator must be informed of this obligation and his responsibility in a way that can be proven (self-adhesive RCD-label enclosed). The test intervall of 6 month is valid for residential and similar applications. Under all other conditions (e.g. damply or dusty environments), it's recommended to test in shorter intervalls (e.g. monthly).
- Pressing the test key "T" serves the only purpose of function testing the residual current device (RCD). This test does not make earthing resistance measurement ( $R_E$ ), or proper checking of the earth conductor condition redundant, which must be performed separately.
- **Type -A:** Protects against special forms of residual pulsating DC which have not been smoothed.
- **Type -G:** High reliability against unwanted tripping. Suitable for any circuit where personal injury or damage to property may occur in case of unwanted tripping.
- **Type -G/A:** Additionally protects against special forms of residual pulsating DC which have not been smoothed.  
Special types for X-ray application PFIM-...-R
- **Type -R:** To avoid unwanted tripping due to X-ray devices.
- **Type -S:** Selective residual current device sensitive to AC, type -S. Suitable for systems with surge arresters downstream of the RCD.
- **Type -S/A:** Additionally protects against special forms of residual pulsating DC which have not been smoothed.
- **Type -F:** Suitable for speed-controlled drives with frequency converters in household, trade, and industry.  
Unwanted tripping is avoided thanks to a tripping characteristic designed particularly for frequency converters.

**Accessories:**

|  |              |        |
|--|--------------|--------|
| Auxiliary switch for subsequent installation to the left         | Z-HK         | 248432 |
| Tripping signal contact for subsequent installation to the right | Z-NHK        | 248434 |
| Remote control and automatic switching device                    | Z-FW/LP      | 248296 |
| Sealing cover set  | Z-RC/AK-2TE  | 285385 |
|  | Z-RC/AK-4 MU | 101062 |



## Technical Data

|   |                   | PFIM  |
|---|-------------------|---|
| <b>Electrical</b>   |                   |   |
| Design according to   |                   | IEC/EN 61008<br>Type G according to ÖVE E 8601                            |
| Current test marks as printed onto the device   |                   |   |
| Tripping  |                   | instantaneous   |
| Type G, R   |                   | 10 ms delay   |
| Type S  |                   | 40 ms delay - selective disconnecting function                            |
| Type U (only 30 mA)   |                   | 10 ms delay   |
| Type U (without 30 mA)  |                   | 40 ms delay - selective disconnecting function                            |
| Rated voltage   | $U_n$             | 230/400 V AC, 50 Hz   |
| Rated tripping current  | $I_{\Delta n}$    | 10, 30, 100, 300, 500 mA  |
| Sensitivity   |                   | AC and pulsating DC   |
| Rated insulation voltage  | $U_i$             | 440 V   |
| Rated impulse withstand voltage   | $U_{imp}$         | 4 kV (1.2/50 $\mu$ s)   |
| Rated short-circuit strength  | $I_{cn}$          | 10 kA   |
| Maximum back-up fuse PFIM   |                   |   |
| <b>Rating</b>   | <b>Fuses</b>      | <b>MCB's (Characteristic B/C)</b>   |
| $I_n$ [A]   | Short-circuit [A] | Short-circuit [A]   |
| 16  | 63 gG/gI          | 10 gG/gI  |
| 25  | 63 gG/gI          | 16 gG/gI  |
| 40  | 63 gG/gI          | 25 gG/gI  |
| 63  | 63 gG/gI          | 40 gG/gI  |
| 80  | 80 gG/gI          | 50 gG/gI  |
| 100   | 100 gG/gI         | 63 gG/gI  |
| Type PFIM-X:  |                   |   |
| 40  | 63 gG/gI          | 40 gG/gI  |
| 63  | 63 gG/gI          | 63 gG/gI  |
| Overload [A]  |                   | Overload [A]  |
| –   |                   | –   |
| C20   |                   | C20   |
| C25   |                   | C25   |
| C40   |                   | C40   |
| –   |                   | –   |
| –   |                   | –   |
| C25   |                   | C25   |
| C40   |                   | C40   |
| <b>Important:</b> In the case that the maximal possible operating current of the electrical installation don't exceed the rated current of the RCD only short-circuit protection must be implemented. Overload protection must be implemented in the case if the maximal possible operating current of the electrical installation can exceed the rated current of the RCD. |                   |   |
| Rated breaking capacity   | $I_m$             |   |
| Rated fault breaking capacity   | $I_{\Delta m}$    |   |
| $I_n = 16-40$ A   |                   | 500 A   |
| $I_n = 63$ A  |                   | 630 A   |
| $I_n = 80$ A  |                   | 800 A   |
| $I_n = 100$ A   |                   | 1000 A  |
| Voltage range of test button  |                   |   |
| 2-pole  |                   | 196 - 264 V~  |
| 4-pole 30 mA  |                   | 196 - 264 V~  |
| 4-pole 10, 100, 300, 500 mA   |                   | 196 - 456 V~  |
| Endurance   |                   |   |
| electrical components   |                   | $\geq 4,000$ switching operations   |
| mechanical components   |                   | $\geq 20,000$ switching operations  |
| <b>Mechanical</b>   |                   |   |
| Frame size  |                   | 45 mm   |
| Device height   |                   | 80 mm   |
| Device width  |                   | 35 mm (2 MU), 70 mm (4 MU)  |
| Mounting  |                   | quick fastening with 2 lock-in positions on DIN rail IEC/EN 60715         |
| Degree of protection, built-in  |                   | IP40  |
| Degree of protection in moisture-proof enclosure  |                   | IP54  |
| Upper and lower terminals   |                   | open-mouthed/lift terminals   |
| Terminal protection   |                   | finger and hand touch safe, DGVV VS3, EN 50274                            |
| Terminal capacity   |                   | 1.5 - 35 mm <sup>2</sup> single wire<br>2 x 16 mm <sup>2</sup> multi wire |
| Terminal screw  |                   | M5 (mit geschlitzter Schraube according to EN ISO 4757-Z2, Pozidriv PZ2)  |
| Terminal torque   |                   | 2 - 2.4 Nm  |
| Busbar thickness  |                   | 0.8 - 2 mm  |
| Operating temperature   |                   | -25°C to +40°C  |
| Storage- and transport temperature  |                   | -35°C to +60°C  |
| Resistance to climatic conditions   |                   | 25-55°C/90-95% relative humidity according to IEC 60068-2                 |

Connection diagrams

2-pole

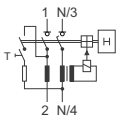

4-pole

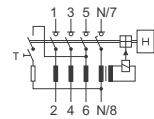

Dimensions (mm)

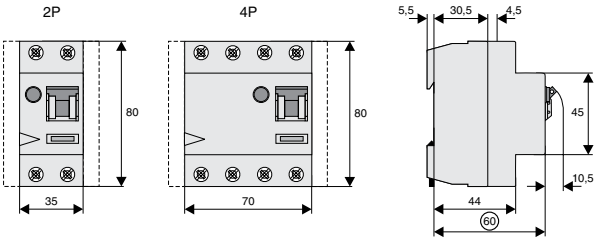

Correct connection

2-pole

30, 100, 300, 500mA types:

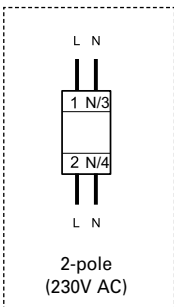

4-pole

30mA types:

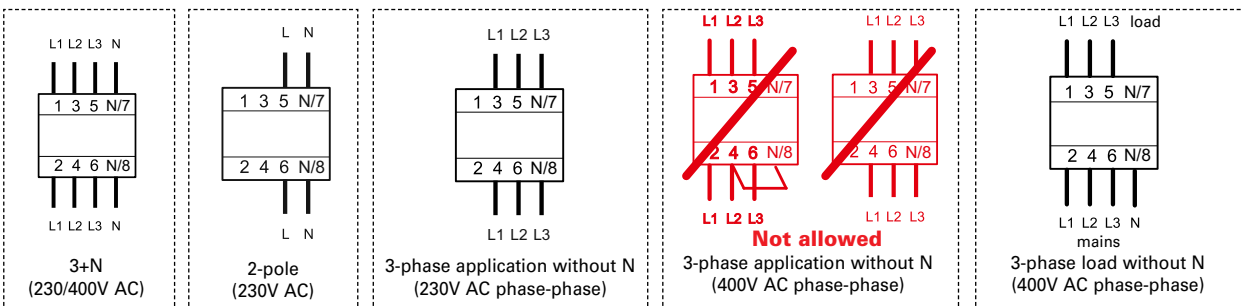

10, 100, 300, 500mA types:

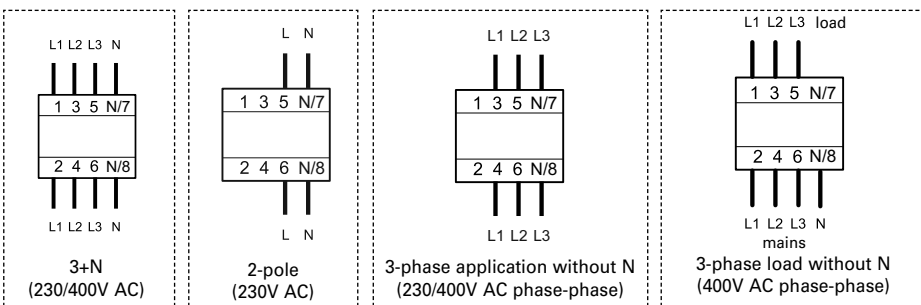

**Influence of the ambient temperature to the maximum continuous current (A)**

| Ambient temperature | 16A  |    | 25A |    | 40A |    | 63A |    | 80A |    | 100A |     |
|---------------------|------|----|-----|----|-----|----|-----|----|-----|----|------|-----|
|                     | 2p   | 4p | 2p  | 4p | 2p  | 4p | 2p  | 4p | 2p  | 4p | 2p   | 4p  |
| 40°                 | 16   | 16 | 25  | 25 | 40  | 40 | 63  | 63 | 80  | 80 | 100  | 100 |
| 45°                 | 14   | 14 | 21  | 22 | 37  | 37 | 59  | 59 | 76  | 76 | 95   | 95  |
| 50°                 | 11   | 11 | 18  | 19 | 33  | 34 | 55  | 55 | 72  | 72 | 90   | 90  |
| 55°                 | 9    | 9  | 14  | 16 | 30  | 31 | 50  | 50 | 68  | 68 | 85   | 85  |
| 60°                 | – *) | –  | –   | –  | 26  | 27 | 45  | 45 | 64  | 64 | 80   | 80  |

Annotation: It has to be ensured that the values in the table are not exceeded and the back-up fuse/thermal protection works properly.

\*) not applicable

Eaton's electrical business is a global leader with deep regional application expertise in power distribution and circuit protection; power quality, backup power and energy storage; control and automation; life safety and security; structural solutions; and harsh and hazardous environment solutions. Through end-to-end services, channel and an integrated digital platform & insights Eaton is powering what matters across industries and around the world, helping customers solve their most critical electrical power management challenges.

For more information, visit [Eaton.com](https://www.eaton.com).



**Eaton Industries (Austria) GmbH**  
Scheydgasse 42  
1210 Vienna  
Austria

**Eaton**  
EMEA Headquarters  
Route de la Longeraie 7  
1110 Morges, Switzerland

© 2022 Eaton  
All Rights Reserved  
Publication No. CA019029EN  
Article number 302701-MK  
June 2022

Changes to the products, to the information contained in this document, and to prices are reserved; as are errors and omissions. Only order confirmations and technical documentation by Eaton is binding. Photos and pictures also do not warrant a specific layout or functionality. Their use in whatever form is subject to prior approval by Eaton. The same applies to trademarks (especially Eaton, Moeller, and Cutler-Hammer). The Terms and Conditions of Eaton apply, as referenced on Eaton Internet pages and Eaton order confirmations.

Eaton is a registered trademark.

All other trademarks are property of their respective owners.

Follow us on social media to get the latest product and support information.

