











36 200 661



- Drehumstellung
 - ohne Rosette
 - Griff Ø 60 mm
- Passt zu META**

Passt zu META

| | | |
|--|---------------------------------|---------------|
|  | Bronze gebürstet | 36 200 661-42 |
|  | Chrom | 36 200 661-00 |
|  | Platin gebürstet | 36 200 661-06 |
|  | Dark Chrome | 36 200 661-19 |
|  | Light Gold | 36 200 661-26 |
|  | Light Gold gebürstet | 36 200 661-27 |
|  | Schwarz matt | 36 200 661-33 |
|  | Champagne gebürstet (22kt Gold) | 36 200 661-46 |
|  | Champagne (22kt Gold) | 36 200 661-47 |
|  | Chrom gebürstet | 36 200 661-93 |
|  | Dark Platinum gebürstet | 36 200 661-99 |

Benötigtes Zubehör



- UP-Zweiwege-Umstellung -** 35 202 970 90
- Max. Einbautiefe 160 mm
 - Min. Einbautiefe 115 mm

36 200 661

mm [inches]

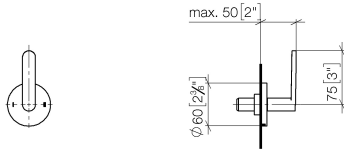

Durchflussdiagramm



Codes & Standards

DIN 4109

ISO 3822

Scottish Water
Byelaws

UK Water Supply
Regulations

Ü-Zeichen



META UP-Zweiwege-Umstellung - Bronze gebürstet

META

36 200 661

Zertifikate

WRAS_2307

LGA_38

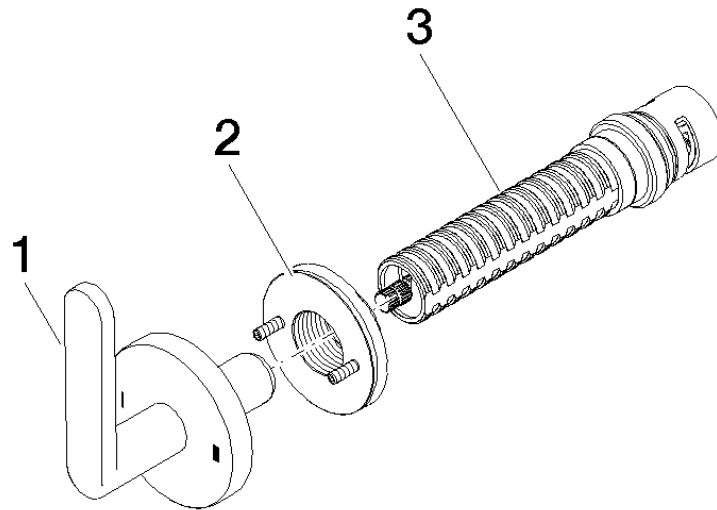



Ersatzteilstückliste