

## Data Sheet | Item Number: 280-551

Triple-deck terminal block; Through/through/through terminal block; for DIN-rail 35 x 15 and 35 x 7.5; 2.5 mm<sup>2</sup>; CAGE CLAMP®; 2,50 mm<sup>2</sup>; blue/blue/blue

<https://www.wago.com/280-551>

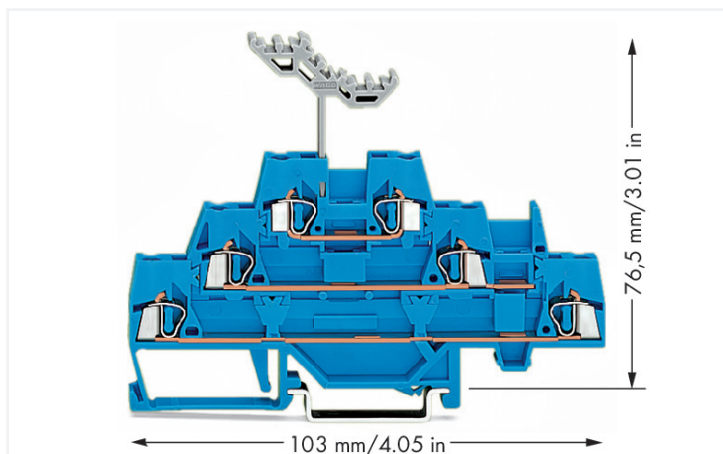

Color: ■ blue/blue/blue

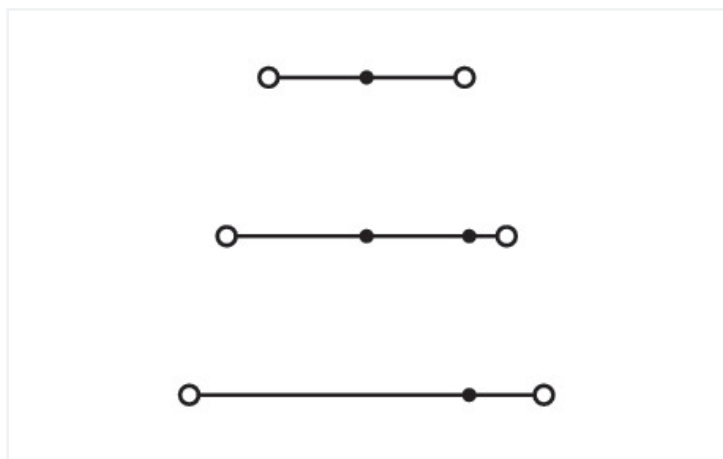

Similar to illustration

Triple-deck terminal block, 280 Series, operating tool

Enjoy effortless electrical installations with this triple-deck terminal block (item number 280-551). Ensure that the strip lengths are between 8 and 9 mm when connecting conductors to this triple-deck terminal block. The triple-deck terminal block also functions as a through terminal block. Featuring conductor terminals along with CAGE CLAMP®, this connector delivers reliable performance. Our reliable and maintenance-free CAGE CLAMP® connection makes it easy to connect all types of conductors without having to prepare the conductor. For example, you don't need to crimp ferrules. This triple-deck terminal block is suitable for conductor cross sections ranging from 0.08 mm<sup>2</sup> to 2.5 mm<sup>2</sup>.

### Electrical data

Ratings per	IEC/EN 60947-7-1		
Overvoltage category	III	III	II
Pollution degree	3	2	2
Nominal voltage	500 V	-	-
Rated impulse withstand voltage	6 kV	-	-
Rated current	20 A	-	-

Power Loss	
Power loss, per pole (potential)	0.532 W
Rated current $I_N$ for power loss specification	20 A
Resistance value for specified, current-dependent power loss	0.00133 Ω

### General information

Wiring direction	Front-entry wiring
------------------	--------------------

### Connection Data

Clamping units	6
Total number of potentials	3
Number of levels	3

#### Connection 1

Connection technology	CAGE CLAMP®
Actuation type	Operating tool
Connectable conductor materials	Copper Aluminum

Connectable conductor materials (note) **Terminating Aluminum Conductors**  
WAGO Spring-Clamp Terminal Blocks are suitable for solid aluminum conductors up to 4 mm<sup>2</sup>/12 AWG if WAGO "Alu-Plus" Contact Paste [249-130](#) is used for termination.

"Alu-Plus" Contact Paste Advantages:

- Automatically destroys the oxide film during clamping.
- Prevents fresh oxidation at the clamping point.
- Prevents electrolytic corrosion between aluminum and copper conductors (in the same terminal block).
- Provides long-term protection against corrosion.

Using terminal blocks with CAGE CLAMP® Spring Pressure Connection Technology, **aluminum conductors must first be cleaned with a blade** and then immediately inserted into the clamping units filled with "Alu-Plus" contact paste.

It is also possible to apply WAGO "Alu-Plus" **additionally** on the whole surface of the aluminum conductor before termination.

Please note that the nominal currents must be adapted to the reduced conductivity of the aluminum conductors:  
2.5 mm<sup>2</sup> = 16 A  
4 mm<sup>2</sup> = 22 A

Solid conductor	0.08 ... 2.5 mm <sup>2</sup> / 28 ... 12 AWG
Fine-stranded conductor	0.08 ... 2.5 mm <sup>2</sup> / 28 ... 12 AWG
Note (conductor cross-section)	12 AWG: THHN, THWN
Strip length	8 ... 9 mm / 0.31 ... 0.35 inches
Wiring direction	Front-entry wiring

### Physical data

Width	5 mm / 0.197 inches
Height	103 mm / 4.055 inches
Depth from upper-edge of DIN-rail	76.5 mm / 3.012 inches

### Mechanical data

Design	horizontal type
Mounting type	DIN-35 rail
Marking level	Center marking

### Material data

Note (material data)	<a href="#">Information on material specifications can be found here</a>
Color	blue/blue/blue
Material group	I
Insulation material (main housing)	Polyamide (PA66)
Flammability class per UL94	V0
Fire load	0.281 MJ
Weight	18.3 g

### Environmental requirements

Processing temperature	-35 ... +85 °C
Continuous operating temperature	-60 ... +105 °C

### Commercial data

Product Group	1 (Rail Mounted Terminal Blocks)
PU (SPU)	40 pcs
Packaging type	Box
Country of origin	DE
GTIN	4044918543316
Customs tariff number	85369010000

### Product Classification

UNSPSC	39121410
eCl@ss 10.0	27-14-11-20
eCl@ss 9.0	27-14-11-20
ETIM 9.0	EC000897
ETIM 10.0	EC000897
ECCN	NO US CLASSIFICATION

### Environmental Product Compliance

RoHS Compliance Status	Compliant, No Exemption
------------------------	-------------------------

### Approvals / Certificates

#### General approvals



Approval	Standard	Certificate Name
CSA DEKRA Certification B.V.	C22.2	1536071
KEMA/KEUR DEKRA Certification B.V.	EN 60947	71-154769
UR Underwriters Laboratories Inc.	UL 1059	E45172

#### Declarations of conformity and manufacturer's declarations

Approval	Standard	Certificate Name
EU-Declaration of Conformity WAGO GmbH & Co. KG	-	-
UK-Declaration of Conformity WAGO GmbH & Co. KG	-	-

Approvals for marine applications



Approval	Standard	Certificate Name
ABS American Bureau of Ship- ping	EN 60947	24-0152298-PDA
BV Bureau Veritas S.A.	EN 60947	07436/G0 BV
DNV GL Det Norske Veritas, Ger- manischer Lloyd	-	TAE00001V2

Downloads

Environmental Product Compliance

Compliance Search
Environmental Product Compliance 280-551 <a href="#">↓</a>

Documentation

Bid Text			
280-551	19.02.2019	xml 3.36 KB	<a href="#">↓</a>
280-551	02.03.2017	doc 24.50 KB	<a href="#">↓</a>

CAD/CAE-Data

CAD data
2D/3D Models 280-551 <a href="#">↓</a>

CAE data
EPLAN Data Portal 280-551 <a href="#">↓</a>
WSCAD Universe 280-551 <a href="#">↓</a>
ZUKEN Portal 280-551 <a href="#">↓</a>

## 1 Compatible Products

### 1.1 Required Accessories

#### 1.1.1 End plate

##### 1.1.1.1 End plate



**Item No.: 280-303**

End and intermediate plate; 2.5 mm thick; gray



**Item No.: 280-304**

End and intermediate plate; 2.5 mm thick; orange



**Item No.: 280-336**

Intermediate plate; 1.1 mm thick; orange

### 1.2 Optional Accessories

#### 1.2.1 DIN-rail

##### 1.2.1.1 Mounting accessories



**Item No.: 210-196**

Aluminum carrier rail; 35 x 8.2 mm; 1.6 mm thick; 2 m long; unslotted; similar to EN 60715; silver-colored



**Item No.: 210-198**

Copper carrier rail; 35 x 15 mm; 2.3 mm thick; 2 m long; unslotted; according to EN 60715; copper-colored



**Item No.: 210-508**

Steel carrier rail; 35 x 15 mm; 1.5 mm thick; 2 m long; slotted; galvanized; similar to EN 60715; silver-colored



**Item No.: 210-197**

Steel carrier rail; 35 x 15 mm; 1.5 mm thick; 2 m long; slotted; similar to EN 60715; silver-colored



**Item No.: 210-506**

Steel carrier rail; 35 x 15 mm; 1.5 mm thick; 2 m long; unslotted; galvanized; similar to EN 60715; silver-colored



**Item No.: 210-114**

Steel carrier rail; 35 x 15 mm; 1.5 mm thick; 2 m long; unslotted; similar to EN 60715; silver-colored



**Item No.: 210-118**

Steel carrier rail; 35 x 15 mm; 2.3 mm thick; 2 m long; unslotted; according to EN 60715; silver-colored



**Item No.: 210-115**

Steel carrier rail; 35 x 7.5 mm; 1 mm thick; 2 m long; slotted; according to EN 60715; silver-colored



**Item No.: 210-112**

Steel carrier rail; 35 x 7.5 mm; 1 mm thick; 2 m long; slotted; according to EN 60715; silver-colored



**Item No.: 210-504**

Steel carrier rail; 35 x 7.5 mm; 1 mm thick; 2 m long; slotted; galvanized; according to EN 60715; silver-colored



**Item No.: 210-113**

Steel carrier rail; 35 x 7.5 mm; 1 mm thick; 2 m long; unslotted; according to EN 60715; silver-colored



**Item No.: 210-505**

Steel carrier rail; 35 x 7.5 mm; 1 mm thick; 2 m long; unslotted; galvanized; according to EN 60715; silver-colored

#### 1.2.2 Ferrule

##### 1.2.2.1 Ferrule



**Item No.: 216-301**

Ferrule; Sleeve for 0.25 mm<sup>2</sup> / AWG 24; insulated; electro-tin plated; yellow



**Item No.: 216-302**

Ferrule; Sleeve for 0.34 mm<sup>2</sup> / 22 AWG; insulated; electro-tin plated; light turquoise



**Item No.: 216-201**

Ferrule; Sleeve for 0.5 mm<sup>2</sup> / 20 AWG; insulated; electro-tin plated; electrolytic copper; acc. to DIN 46228, Part 4/09.90; white



**Item No.: 216-101**

Ferrule; Sleeve for 0.5 mm<sup>2</sup> / AWG 22; un-insulated; electro-tin plated; silver-colored



**Item No.: 216-202**

Ferrule; Sleeve for 0.75 mm<sup>2</sup> / 18 AWG; insulated; electro-tin plated; gray



**Item No.: 216-102**

Ferrule; Sleeve for 0.75 mm<sup>2</sup> / AWG 20; un-insulated; electro-tin plated; silver-colored



**Item No.: 216-203**

Ferrule; Sleeve for 1 mm<sup>2</sup> / AWG 18; insulated; electro-tin plated; red



**Item No.: 216-103**

Ferrule; Sleeve for 1 mm<sup>2</sup> / AWG 18; un-insulated; electro-tin plated



**Item No.: 216-204**

Ferrule; Sleeve for 1.5 mm<sup>2</sup> / AWG 16; insulated; electro-tin plated; black



**Item No.: 216-104**

Ferrule; Sleeve for 1.5 mm<sup>2</sup> / AWG 16; un-insulated; electro-tin plated; silver-colored

### 1.2.3 Installation

#### 1.2.3.1 Cover



**Item No.: 709-154**

Cover; Type 2; suitable for cover carrier, type 2; 1 m long; transparent

#### 1.2.3.2 Cover carrier



**Item No.: 709-168**

Cover carrier; Type 2; incl. fixing/retaining screws and knurled nut; suitable for 283 to 285 Series rail-mounted terminal blocks; suitable for 279 to 281 Series double- and triple-deck terminal blocks; suitable for 780 to 785, 775, 776 and 777 Series TOP-JOB® rail-mounted terminal blocks; suitable for 280 Series sensor and actuator terminal blocks; suitable for 282 Series disconnect/test terminal blocks for transformer circuits; gray

#### 1.2.3.3 Mounting accessories



**Item No.: 209-106**

Mounting carrier; for isolated mounting on DIN 35 rails; gray



**Item No.: 249-116**

Screwless end stop; 6 mm wide; for DIN-rail 35 x 15 and 35 x 7.5; gray

### 1.2.4 Insulation stop

#### 1.2.4.1 Insulation stop



**Item No.: 280-470**

Insulation stop; 0.08 - 0.2 mm<sup>2</sup> "s" (0.14 mm<sup>2</sup> "f-st"); 5 pieces/strip; white



**Item No.: 280-471**

Insulation stop; 0.25 - 0.5 mm<sup>2</sup>; 5 pieces/strip; light gray



**Item No.: 280-472**

Insulation stop; 0.75 - 1 mm<sup>2</sup>; 5 pieces/strip; black

### 1.2.5 Jumper

#### 1.2.5.1 Jumper



**Item No.: 280-490**

Jumper; 10-way; insulated; gray



**Item No.: 280-482**

Jumper; 2-way; insulated; gray



**Item No.: 280-492**

Jumper; 2-way; insulated; gray



**Item No.: 280-483**

Jumper; 3-way; insulated; gray



**Item No.: 280-484**

Jumper; 4-way; insulated; gray



**Item No.: 280-485**

Jumper; 5-way; insulated; gray



**Item No.: 280-402**

Jumper; insulated; gray



**Item No.: 280-409**

Jumper; insulated; gray



**Item No.: 780-452**

Staggered jumper; from 1 to 2; insulated; gray



**Item No.: 780-453**

Staggered jumper; from 1 to 3; insulated; gray



**Item No.: 780-454**

Staggered jumper; from 1 to 4; insulated; gray



**Item No.: 780-455**

Staggered jumper; from 1 to 5; insulated; gray

1.2.5.1 Jumper



**Item No.: 780-456**  
Staggered jumper; from 1 to 6; insulated; gray

**Item No.: 780-457**  
Staggered jumper; from 1 to 7; insulated; gray

**Item No.: 780-458**  
Staggered jumper; from 1 to 8; insulated; gray

**Item No.: 281-421**  
Vertical jumper; insulated; gray



**Item No.: 709-110**  
Wire commoning chain; 2.5 mm<sup>2</sup>; insulated; black

**Item No.: 709-111**  
Wire commoning chain; 2.5 mm<sup>2</sup>; insulated; black

**Item No.: 709-112**  
Wire commoning chain; 2.5 mm<sup>2</sup>; insulated; black

**Item No.: 210-103**  
Wire commoning chain; insulated; black



**Item No.: 210-123**  
Wire commoning chain; insulated; blue

1.2.6 Marking

1.2.6.1 Marker



**Item No.: 793-5501**  
WMB marking card; as card; for terminal block width 5 - 17.5 mm; stretchable 5 - 5.2 mm; plain; snap-on type; white

**Item No.: 793-501**  
WMB marking card; as card; not stretchable; plain; snap-on type; white

**Item No.: 2009-115**  
WMB-Inline; for Smart Printer; 1500 pieces on roll; stretchable 5 - 5.2 mm; plain; snap-on type; white

1.2.7 Protective warning marker

1.2.7.1 Cover



**Item No.: 280-415**  
Protective warning marker; for 5 terminal blocks; with high-voltage symbol, black; yellow

1.2.8 Push-in type wire jumper

1.2.8.1 Jumper



**Item No.: 249-126**  
Push-in type wire jumper; 0.75 mm<sup>2</sup>; insulated; 110 mm long; black

**Item No.: 249-123**  
Push-in type wire jumper; 0.75 mm<sup>2</sup>; insulated; 180 mm long; black

**Item No.: 249-127**  
Push-in type wire jumper; 0.75 mm<sup>2</sup>; insulated; 250 mm long; black

**Item No.: 249-125**  
Push-in type wire jumper; insulated; 60 mm long; black

1.2.9 Test and measurement

1.2.9.1 Testing accessories



**Item No.: 249-142**  
L-type end module; modular; with rigid contact pin; End module; 1,50 mm<sup>2</sup>; gray

**Item No.: 249-141**  
L-type test plug module; modular; with spring-loaded contact pin; Center module; 1,50 mm<sup>2</sup>; gray

## 1.2.10 Tool

### 1.2.10.1 Operating tool



**Item No.: 210-658**

Operating tool; Blade: 3.5 x 0.5 mm; with a partially insulated shaft; angled; short; multicoloured



**Item No.: 210-720**

Operating tool; Blade: 3.5 x 0.5 mm; with a partially insulated shaft; multicoloured



**Item No.: 210-657**

Operating tool; Blade: 3.5 x 0.5 mm; with a partially insulated shaft; short; multicoloured

## Installation Notes

### Installation

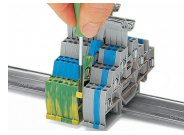
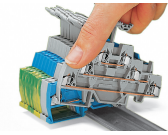

Snapping a terminal block onto the DIN-rail.

Removing a terminal block from the assembly.

## Conductor termination

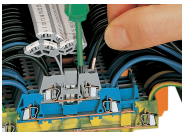

**CAGE CLAMP® connection**

Inserting a conductor.

With ferruled conductors, it is necessary to use a terminal block one size smaller than the conductor's nominal cross-section.

## Commoning

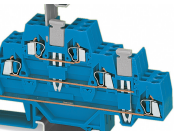

A vertical jumper commons the upper and lower decks, creating a 6-conductor feed-through terminal block in one housing. Two adjacent triple-deck terminal blocks may be commoned together on the same deck using a push-in adjacent jumper.

Combining vertical and adjacent jumpers.

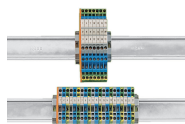

Use 67% less rail space with triple-deck terminal blocks.

## Marking



Labeling via WMB Multi Marking System.