







CL.1 Deck valve clockwise closing cold - Brushed Platinum

CL.1

20 001 705 Product version from 3/9/2015



- with WAVES structure
- hole diameter 32 mm
- rosette 60 x 60 mm
- with cold marking
- WRAS

	Brushed Platinum	20 001 705-06
	Chrome	20 001 705-00
	Dark Chrome	20 001 705-19
	Brushed Light Gold (PVD)	20 001 705-27
	Brushed Champagne (22kt Gold)	20 001 705-46
	Champagne (22kt Gold)	20 001 705-47
	Brushed Dark Platinum	20 001 705-99

20 001 705 Product version from 3/9/2015

mm [inches]

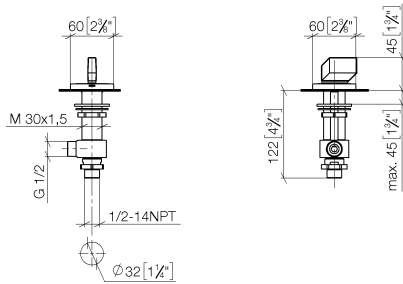

Flow rate chart



Codes & Standards

ASME A112.18.1	cUPC	DIN 4109	ISO 3822
Scottish Water Byelaws	UK Water Supply Regulations	Ü-Zeichen	



CL.1 Deck valve clockwise closing cold - Brushed Platinum

CL.1

20 001 705 Product version from 3/9/2015

Certificates and sustainability

IAPMO_4976

LGA_28

WRAS_2103

EPD-DOR-20230287
-IBA1-EN
Environmental.prod
uct-declarat

20 001 705 Product version from 3/9/2015

Parts for other finishes can be found here: [Chrome](#)

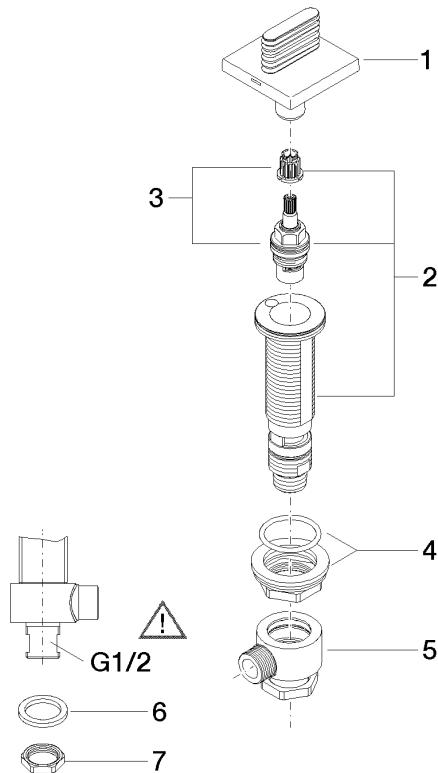

Spare parts list

No.	Item Number	Name	Quantity used	Delivery time
7	09 30 11 059 90	Disc -	1.00	14
6	90 23 30 040 00-06	Union piece - Brushed Platinum	1.00	20
4	04 23 10 032 78 90	Mounting with seals M30 x 1,5 -	1.00	14
1	90 20 70 055 04-06	Handle for bath Cold oval wave 60 x 60 x 40 mm - Brushed Platinum	1.00	20
8	09 23 10 012 90	Mounting Nut SW 24 1/2" -	1.00	14
2	04 17 11 058 33 90	Side piece clockwise closing, G 1/2, 180° -	1.00	14
5	04 17 11 023 10 90	Connection Distributor, complete 1/2" -	1.00	14
3	90 90 03 133 00 90	Head part clockwise closing extended, 7mm 1/2" -	1.00	14