

















28 508 360



- Ausladung 200 mm
- Kugelgelenk 30° schwenkbar
- Dreifach verstellbar: COMPACT RAIN, COMPACT SOFT FLOW, COMPACT AQUAPRESSURE FLOW, Durchfluss max. 9 l/min (bei 3 Bar)
- Funktion ab: 7 l/min
- mit Antikalk-System
- Brausekopf Ø 94 mm
- Rosette Ø 55 mm
- Anschluss 1/2"

	Bronze gebürstet	28 508 360-42
	Chrom	28 508 360-00 0010
	Chrom	28 508 360-00
	Gold (23,9kt)	28 508 360-01
	Platin gebürstet	28 508 360-06 0010
	Platin gebürstet	28 508 360-06
	Platin	28 508 360-08 0010
	Platin	28 508 360-08
	Messing (23kt Gold)	28 508 360-09 0010
	Messing (23kt Gold)	28 508 360-09
	Dark Brass matt	28 508 360-16
	Dark Bronze matt	28 508 360-17
	Messing gebürstet (23kt Gold)	28 508 360-28
	Messing gebürstet (23kt Gold)	28 508 360-28 0010
	Bronze gebürstet	28 508 360-42 0010
	Dark Platinum gebürstet	28 508 360-99
	Dark Platinum gebürstet	28 508 360-99 0010

28 508 360

mm [inches]

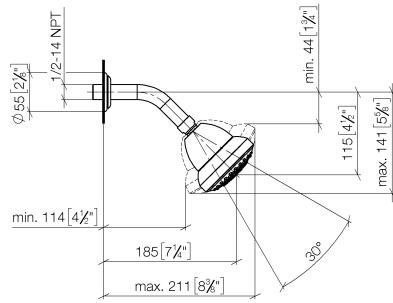

**Durchflussdiagramm**



28 508 360

Ersatzteile für die  
anderen  
Oberflächenvarianten  
finden Sie hier:  
Chrom

