

Product data sheet Spirotech

Product name

EPCK Solo 500L max 4bar

Article number

EPCK-S500-4.0

Product properties

The PicoControl Kompakt SOLO is a compact automatic expansion and pressure-maintaining device. The unit contains 1 pump (1x 100%) and an overflow valve. An unpressurized expansion tank is integrated.

- 1 pump (1x 100%)
- One mechanical overflow valve (1x 100%)
- Operational pressure range up to 4.0 bar
- 6 possible expansion tank volumes: 45 - 500 liters
- Two further unpressurized expansion tanks can be added
- Maximum expansion volume: 45 – 1,500 liters
- The maximum temperature at the point of connection: 70°C (over 70°C possible with auxiliary tank)
- Maximum safety temperature in the system: 110°C
- Maximum allowable pressure (PN): 6 bar

Product image



Product dimensions

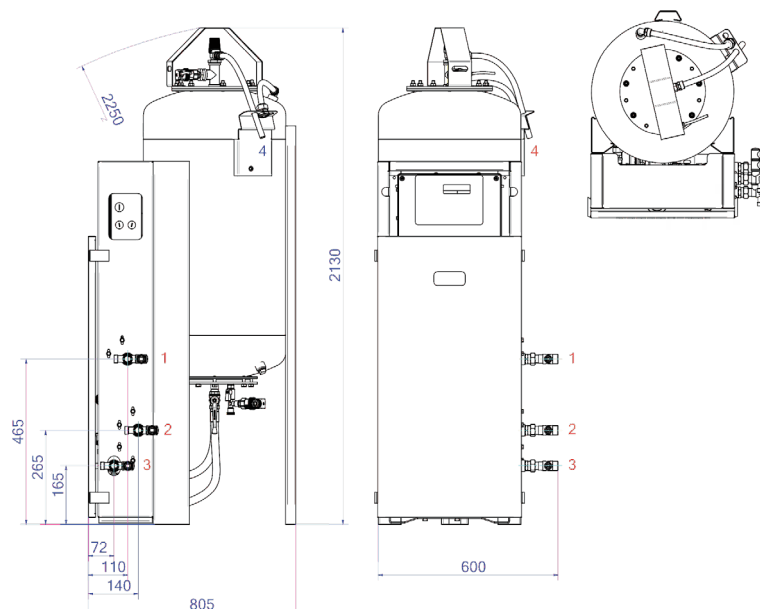

1. Refill connection R3/4

2. Expansion overflow pipe R3/4

3. Expansion pressure pipe R3/4

4. Drain funnel tank safety valve PA 15x12,5 mm

Product data sheet Spirotech

ETIM product data

Height	2130 mm	Double pump	No
Volume	500 l	With exchangeable membrane	Yes
Max. operating pressure	4 bar	Compressor in base	No
Connection	Other	Nominal diameter expansion connection	3/4 inch (20)
Power consumption	0.22 kW	Max. medium temperature (continuous)	70 °C
Couplable	Yes	For heating systems up to	1 MW
Electrical connection	Connection cable with plug	Horizontal positioning	No
Function master/slave	No	Connection voltage	230 V
With pressure expansion vessel	Yes	Article compression class	PN 6
Digital control unit	Yes		

Disclaimer

This product sheet has been compiled with the greatest possible care. Nevertheless, it may contain errors or omissions. For the most current and correct information we refer you to our website

