

Productinformatieblad

Specificaties



Drukknop Ø22mm - met kapje Groen

ZB4BPA3

EAN Code: 3389110966534

Prijs: 12,45 EUR

Hoofd

range of product	Harmony XB4
product of component type	Kop voor niet-verlichte drukknop
device short name	ZB4
compatibiliteit product	niet compatibel met legendahouder
kraag materiaal	Verchroomd metaal
bevestigingsdiameter	22,5 mm
verkoop per ondeelbare hoeveelheid	1
koptype	Standaard
vorm van kop signaleringseenheid	Rond
type operator	terugverend
operator profiel	Groen verzonken, niet gemarkeerd
extra informatie operator	Heldere beschermkap
kap/operator of lenskleur	Groen

Complementair

CAD totale breedte	30 mm
CAD totale hoogte	30 mm
CAD totale diepte	37 mm
mechanical durability	10000000 cycles
product presentatie	Basisonderdeel

Omgeving

beschermende behandeling	TH
ambient air temperature for storage	-40...70 °C
omgevingstemperatuur voor werking	-40...70 °C
overvoltage category	Klasse I In overeenstemming met IEC 60536
IP beschermingsgraad	IP66 In overeenstemming met IEC 60529 IP67
Enclosure Type	UL type 4X/13
IK-beschermingsgraad	IK06 In overeenstemming met IEC 50102

De weergegeven prijs is de adviesprijs in euro excl. BTW. Deze kan onderhevig zijn aan korting. Neem contact op met uw lokale distributeur of detailhandel voor de daadwerkelijke prijs

standards	CSA C22.2 Nr 14 IEC 60947-1 JIS C8201-5-1 IEC 60947-5-1 UL 508 IEC 60947-5-4 IEC 60947-5-5 JIS C8201-1
product certifications	BV CSA DNV LROS (Lloyds register of shipping) UL listed
trilling bestendigheid	5 gn (f= 2...500 Hz) In overeenstemming met IEC 60068-2-6
schokbestendigheid	30 gn (duur = 18 ms) voor halve sinusgolf versnelling In overeenstemming met IEC 60068-2-27 50 gn (duur = 11 ms) voor halve sinusgolf versnelling In overeenstemming met IEC 60068-2-27

Verpakkingseenheid

Eenheidstype van verpakking 1	PCE
Aantal eenheden in verpakking 1	1
verpakking 1 hoogte	3,6 cm
verpakking 1 breedte	4,8 cm
verpakking 1 lengte	3,0 cm
verpakking_1_gewicht	30,0 g
Eenheidstype van verpakking 2	S02
Aantal eenheden in verpakking 2	100
verpakking 2 hoogte	15,0 cm
verpakking 2 breedte	30,0 cm
verpakking 2 lengte	40,0 cm
verpakking 2 gewicht	3,408 kg

contractuele waarborg

Garantie (in maanden)	18
------------------------------	----

Schneider Electric wil tegen 2050 de Net Zero-status hebben bereikt via partnerschappen in de toeleveringsketen, materialen met een lagere impact en circulariteit via onze doorlopende campagne "Use Better, Use Longer, Use Again" om de levensduur van producten en de recycleerbaarheid te verlengen.

[Uitleg van Environmental Data >](#)

[Hoe evalueren we de duurzaamheid van producten? >](#)

Milieuvoetafdruk

Totale levenscyclus ecologische voetafdruk	0.3 kg CO2 eq.
Koolstofvoetafdruk van de fabricagefase [A1–A3]	0.2 kg CO2 eq.
Koolstofvoetafdruk van de distributiefase [A4]	0 kg CO2 eq.
Koolstofvoetafdruk van de installatiefase [A5]	0 kg CO2 eq.
Koolstofvoetafdruk van de gebruiksfase [B2, B3, B4, B6]	0 kg CO2 eq.
Koolstofvoetafdruk van de einde-levensfase [C1–C4]	0 kg CO2 eq.

Use Better

Materialen en verpakking

Gemiddeld percentage gerecycleerde kunststof	14 %
Gemiddeld percentage gerecycleerd metaal	21 %
Pakket met gerecycleerd karton	Ja
Verpakkingen zonder kunststof	Ja
RoHS-richtlijn van de EU	Conform
REACH-verordening	Referentie bevat zorgwekkende stoffen (SVHC) boven drempelwaarde

Use Longer

Levensduurverlenging

Reparatie	Nee
-----------	-----

Use Again

Herverpakken en herfabriceren

Circulair Profiel	Informatie over einde levensduur
Terugname	Ja

Dimensions Drawings

Dimensions

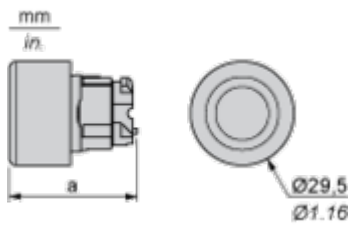

	a in mm	a in in.
ZB4BP••	36.5	1.44
ZB4BP•S	33	1.30
ZB4BP•83	32	1.26
ZB4BP•	35	1.38

Mounting and Clearance

Panel Cut-out for Pushbuttons, Switches and Pilot Lights (Finished Holes, Ready for Installation)

Connection by Screw Clamp Terminals or Plug-in Connectors or on Printed Circuit Board	Connection by Faston Connectors
	
<p>(1) Diameter on finished panel or support (2) 40 mm min. / 1.57 in. min. (3) 30 mm min. / 1.18 in. min. (4) $\varnothing 22.5 \text{ mm} / 0.89 \text{ in. recommended } (\varnothing 22.3 \text{ mm }_0^{+0.4} / 0.88 \text{ in. }_0^{+0.016})$ (5) 45 mm min. / 1.78 in. min. (6) 32 mm min. / 1.26 in. min.</p>	

Pushbuttons, Switches and Pilot Lights for Printed Circuit Board Connection

Panel Cut-outs (Viewed from Installer's Side)

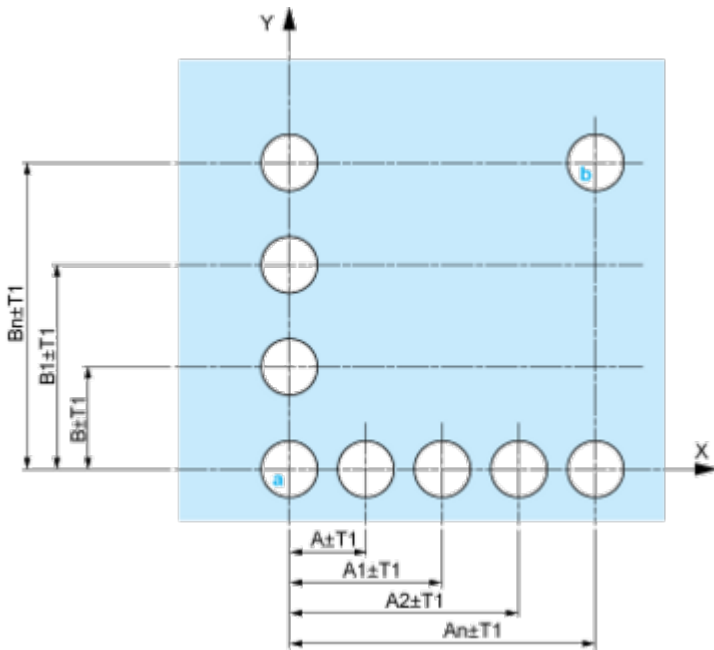

A: 30 mm min. / 1.18 in. min.

B: 40 mm min. / 1.57 in. min.

Printed Circuit Board Cut-outs (Viewed from Electrical Block Side)

Dimensions in mm

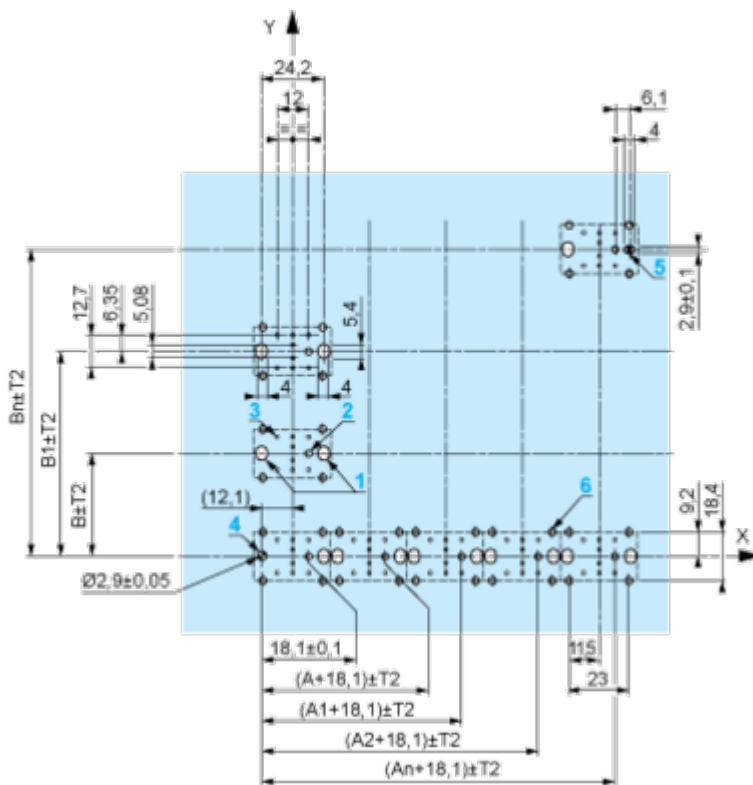

A: 30 mm min.

B: 40 mm min.

Dimensions in in.

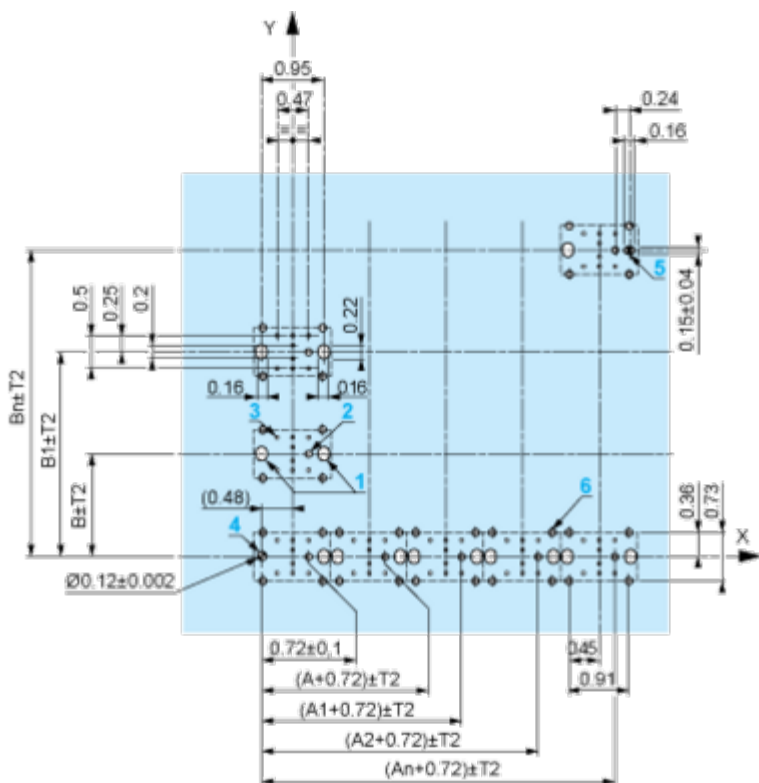

A: 1.18 in. min.

B: 1.57 in. min.

General Tolerances of the Panel and Printed Circuit Board

The cumulative tolerance must not exceed 0.3 mm / 0.012 in: T1 + T2 = 0.3 mm max.

Installation Precautions

- Minimum thickness of circuit board: 1.6 mm / 0.06 in.
- Cut-out diameter: 22.4 mm ± 0.1 / 0.88 in. ± 0.004
- Orientation of body/fixing collar ZB4 BZ009: ± 2° 30' (excluding cut-outs marked a and b).
- Tightening torque of screws ZBZ 006: 0.6 N.m (5.3 lbf.in) max.
- Allow for one ZB4 BZ079 fixing collar/pillar and its fixing screws:
 - every 90 mm / 3.54 in. horizontally (X), and 120 mm / 4.72 in. vertically (Y).
 - with each selector switch head (ZB4 BD*, ZB4 BJ*, ZB4 BG*).

The fixing centers marked a and b are diagonally opposed and must align with those marked 4 and 5.

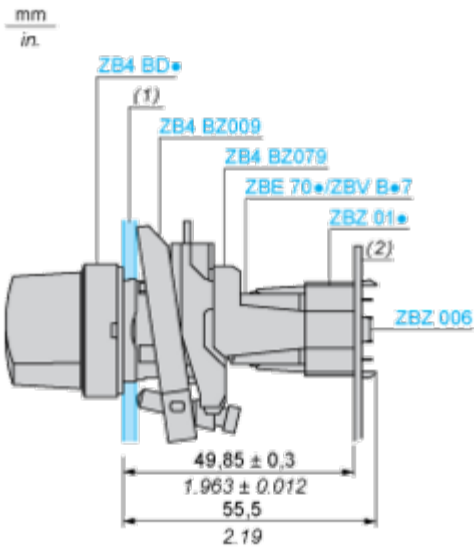

(1) Panel

(2) Printed circuit board

Mounting of Adapter (Socket) ZBZ 01•

- 1 2 elongated holes for ZBZ 006 screw access
- 2 1 hole $\varnothing 2.4 \text{ mm} \pm 0.05 / 0.09 \text{ in.} \pm 0.002$ for centring adapter ZBZ 01•
- 3 $8 \times \varnothing 1.2 \text{ mm} / 0.05 \text{ in.}$ holes
- 4 1 hole $\varnothing 2.9 \text{ mm} \pm 0.05 / 0.11 \text{ in.} \pm 0.002$, for aligning the printed circuit board (with cut-out marked a)
- 5 1 elongated hole for aligning the printed circuit board (with cut-out marked b)
- 6 4 holes $\varnothing 2.4 \text{ mm} / 0.09 \text{ in.}$ for clipping in adapter ZBZ 01•

Dimensions An + 18.1 relate to the $\varnothing 2.4 \text{ mm} \pm 0.05 / 0.09 \text{ in.} \pm 0.002$ holes for centring adapter ZBZ 01•.

Technical Illustration

Dimensions

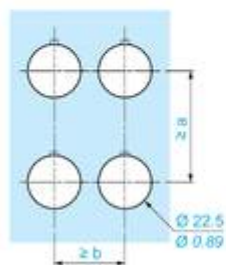
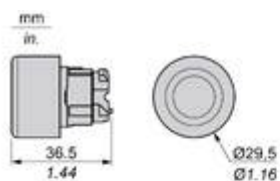

		a (mm)	a (in.)	b (mm)	b (in.)
		40	1.57	30	1.18
ZBE.....	ZBV.....				
		45	1.77	32	1.26
ZBE.....3	ZBV.....3				
		40	1.57	30	1.18
ZBE.....4	ZBV.....4				
		50	1.97	30	1.18
ZBE.....5	ZBV.....5				
		40	1.57	30	1.18
ZBE.....9	ZBV.....9				
		40	1.57	30	1.18
ZBRT•	ZBRV1				



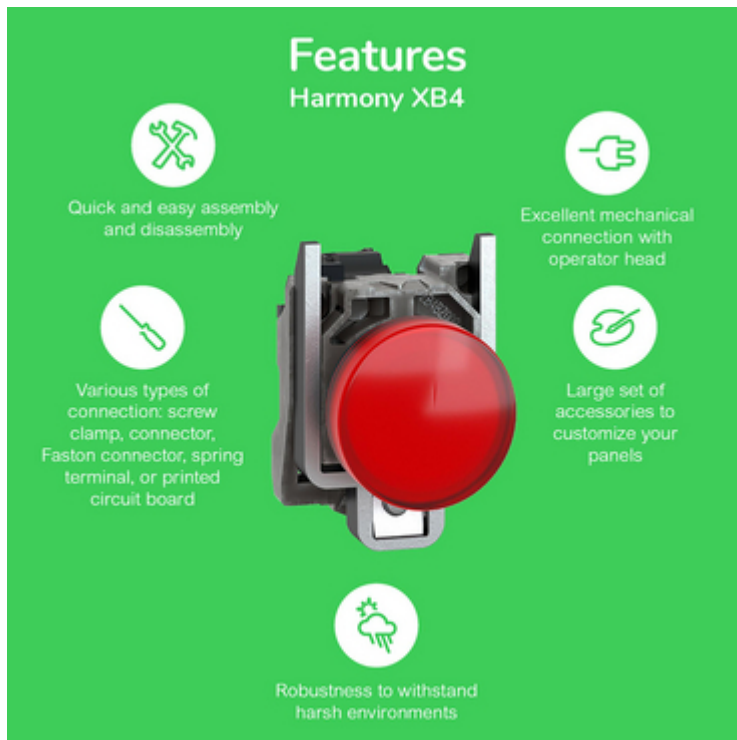

Offer Marketing Illustration

Product benefits / Features



The infographic features a central image of a red Schneider XB4 terminal block. Surrounding it are five circular icons, each with a corresponding text description of a feature. The background is a solid green color.

Features Harmony XB4

-  Quick and easy assembly and disassembly
-  Various types of connection: screw clamp, connector, Faston connector, spring terminal, or printed circuit board
-  Excellent mechanical connection with operator head
-  Large set of accessories to customize your panels
-  Robustness to withstand harsh environments

Offer Marketing Illustration

Product benefits / Features

Technical Benefits

Harmony XB4

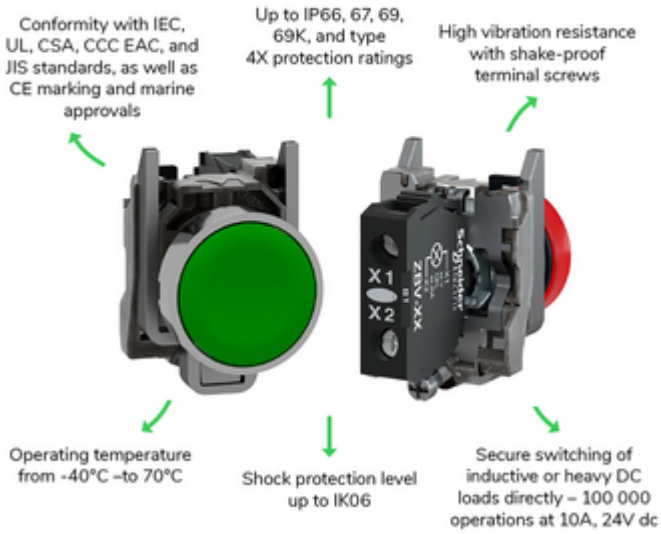

Image of product / Alternate images

Alternative



