

## Data Sheet | Item Number: 281-906

2-conductor through terminal block; 4 mm<sup>2</sup>; center marking; for DIN-rail 35 x 15 and 35 x 7.5; CAGE CLAMP®; 4,00 mm<sup>2</sup>; yellow

<https://www.wago.com/281-906>

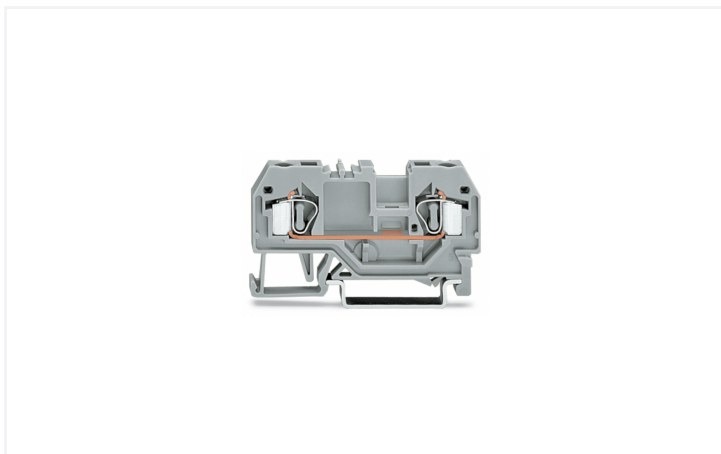

Color: ■ yellow

Similar to illustration

Similar to illustration

Through terminal block, 281 Series, operating tool

This through terminal block (item number 281-906) streamlines wire connections, making them both quick and easy. Ensure that the strip lengths are between 9 and 10 mm when connecting conductors to this through terminal block. Whether for industrial or building applications, you can use our through terminal blocks to connect electrical conductors quickly and safely. We offer variants for both classic through-wiring and potential distribution. This product features conductor terminals and utilizes CAGE CLAMP®. Our celebrated universal connection known as CAGE CLAMP® is industry-leading when it comes to connection technology and electrical interconnections. This through terminal block is suitable for conductor cross sections ranging from 0.08 mm<sup>2</sup> to 4 mm<sup>2</sup>.

This through rail-mount terminal block is operated with an operating tool.

### Electrical data

Ratings per	IEC/EN 60947-7-1		
Overvoltage category	III	III	II
Pollution degree	3	2	2
Nominal voltage	800 V	-	-
Rated impulse withstand voltage	8 kV	-	-
Rated current	32 A	-	-

### Power Loss

Power loss, per pole (potential)	1.024 W
Rated current $I_N$ for power loss specification	32 A
Resistance value for specified, current-dependent power loss	0.001 Ω

### General information

Wiring direction	Front-entry wiring
------------------	--------------------

## Connection Data

Clamping units	2
Total number of potentials	1
Number of levels	1

### Connection 1

Connection technology	CAGE CLAMP®
Actuation type	Operating tool
Connectable conductor materials	Copper Aluminum

Connectable conductor materials (note) **Terminating Aluminum Conductors**  
WAGO Spring-Clamp Terminal Blocks are suitable for solid aluminum conductors up to 4 mm<sup>2</sup>/12 AWG if WAGO "Alu-Plus" Contact Paste [249-130](#) is used for termination.

"Alu-Plus" Contact Paste Advantages:

- Automatically destroys the oxide film during clamping.
- Prevents fresh oxidation at the clamping point.
- Prevents electrolytic corrosion between aluminum and copper conductors (in the same terminal block).
- Provides long-term protection against corrosion.

Using terminal blocks with CAGE CLAMP® Spring Pressure Connection Technology, **aluminum conductors must first be cleaned with a blade** and then immediately inserted into the clamping units filled with "Alu-Plus" contact paste.

It is also possible to apply WAGO "Alu-Plus" **additionally** on the whole surface of the aluminum conductor before termination.

Please note that the nominal currents must be adapted to the reduced conductivity of the aluminum conductors::  
2.5 mm<sup>2</sup> = 16 A  
4 mm<sup>2</sup> = 22 A

Solid conductor	0.08 ... 4 mm <sup>2</sup> / 28 ... 12 AWG
Fine-stranded conductor	0.08 ... 4 mm <sup>2</sup> / 28 ... 12 AWG
Strip length	9 ... 10 mm / 0.35 ... 0.39 inches
Wiring direction	Front-entry wiring

## Physical data

Width	6 mm / 0.236 inches
Height	59 mm / 2.323 inches
Depth from upper-edge of DIN-rail	29 mm / 1.142 inches

## Mechanical data

Design	horizontal type
Mounting type	DIN-35 rail
Marking level	Center marking

### Material data

Note (material data)	<a href="#">Information on material specifications can be found here</a>
Color	yellow
Material group	I
Insulation material (main housing)	Polyamide (PA66)
Flammability class per UL94	V0
Fire load	0.145 MJ
Weight	7.9 g

### Environmental requirements

Processing temperature	-35 ... +85 °C
Continuous operating temperature	-60 ... +105 °C

### Commercial data

PU (SPU)	50 pcs
Packaging type	Box
Country of origin	PL
GTIN	4044918485159
Customs tariff number	85369010000

### Product Classification

UNSPSC	39121410
eCl@ss 10.0	27-14-11-20
eCl@ss 9.0	27-14-11-20
ETIM 9.0	EC000897
ETIM 10.0	EC000897
ECCN	NO US CLASSIFICATION

### Environmental Product Compliance

RoHS Compliance Status	Compliant, No Exemption
------------------------	-------------------------

### Approvals / Certificates

#### General approvals



Approval	Standard	Certificate Name
CSA CSA Group	C22.2	1505034
KEMA/KEUR DEKRA Certification B.V.	EN 60947	71-107288
UL UL International Germany GmbH	UL 1059	E45172

#### Declarations of conformity and manufacturer's declarations

Approval	Standard	Certificate Name
EU-Declaration of Confor- mity WAGO GmbH & Co. KG	-	-

**Approvals for marine applications**



Approval	Standard	Certificate Name
ABS American Bureau of Ship- ping	-	24-0152298-PDA
BV Bureau Veritas S.A.	EN 60947	07436/G0 BV
DNV GL Det Norske Veritas, Ger- manischer Lloyd	-	TAE00001V2
PRS Polski Rejestr Statków	-	TE/1094/880590/23

**Downloads**

**Environmental Product Compliance**

Compliance Search
Environmental Product Compliance 281-906 <a href="#">↓</a>

**Documentation**

Bid Text			
281-906	19.02.2019	xml 3.18 KB	<a href="#">↓</a>
281-906	28.02.2017	doc 24.00 KB	<a href="#">↓</a>

**CAD/CAE-Data**

CAD data
2D/3D Models 281-906 <a href="#">↓</a>

CAE data
EPLAN Data Portal 281-906 <a href="#">↓</a>
WSCAD Universe 281-906 <a href="#">↓</a>
ZUKEN Portal 281-906 <a href="#">↓</a>

## 1 Compatible Products

### 1.1 Required Accessories

#### 1.1.1 End plate

##### 1.1.1.1 End plate



**Item No.: 281-328**

End and intermediate plate; 2.5 mm thick; gray

**Item No.: 281-329**

End and intermediate plate; 2.5 mm thick; orange

**Item No.: 281-330**

Separator plate; 2 mm thick; oversized; gray

**Item No.: 281-331**

Separator plate; 2 mm thick; oversized; orange

### 1.2 Optional Accessories

#### 1.2.1 DIN-rail

##### 1.2.1.1 Mounting accessories



**Item No.: 210-196**

Aluminum carrier rail; 35 x 8.2 mm; 1.6 mm thick; 2 m long; unslotted; similar to EN 60715; silver-colored



**Item No.: 210-198**

Copper carrier rail; 35 x 15 mm; 2.3 mm thick; 2 m long; unslotted; according to EN 60715; copper-colored



**Item No.: 210-508**

Steel carrier rail; 35 x 15 mm; 1.5 mm thick; 2 m long; slotted; galvanized; similar to EN 60715; silver-colored



**Item No.: 210-197**

Steel carrier rail; 35 x 15 mm; 1.5 mm thick; 2 m long; slotted; similar to EN 60715; silver-colored



**Item No.: 210-506**

Steel carrier rail; 35 x 15 mm; 1.5 mm thick; 2 m long; unslotted; galvanized; similar to EN 60715; silver-colored



**Item No.: 210-114**

Steel carrier rail; 35 x 15 mm; 1.5 mm thick; 2 m long; unslotted; similar to EN 60715; silver-colored



**Item No.: 210-118**

Steel carrier rail; 35 x 15 mm; 2.3 mm thick; 2 m long; unslotted; according to EN 60715; silver-colored



**Item No.: 210-115**

Steel carrier rail; 35 x 7.5 mm; 1 mm thick; 2 m long; slotted; according to EN 60715; "Hole width 18 mm; silver-colored



**Item No.: 210-112**

Steel carrier rail; 35 x 7.5 mm; 1 mm thick; 2 m long; slotted; according to EN 60715; "Hole width 25 mm; silver-colored



**Item No.: 210-504**

Steel carrier rail; 35 x 7.5 mm; 1 mm thick; 2 m long; slotted; galvanized; according to EN 60715; silver-colored



**Item No.: 210-113**

Steel carrier rail; 35 x 7.5 mm; 1 mm thick; 2 m long; unslotted; according to EN 60715; silver-colored



**Item No.: 210-505**

Steel carrier rail; 35 x 7.5 mm; 1 mm thick; 2 m long; unslotted; galvanized; according to EN 60715; silver-colored

#### 1.2.2 End plate

##### 1.2.2.1 End plate



**Item No.: 284-334**

Step-down cover plate; 1 mm thick; for 2-, 3- and 4-conductor terminal blocks; gray



**Item No.: 284-344**

Step-down cover plate; 1 mm thick; for 2-, 3- and 4-conductor terminal blocks; orange

#### 1.2.3 Ferrule

##### 1.2.3.1 Ferrule



**Item No.: 216-241**

Ferrule; Sleeve for 0.5 mm<sup>2</sup> / 20 AWG; insulated; electro-tin plated; electrolytic copper; gastight crimped; acc. to DIN 46228, Part 4/09.90; white



**Item No.: 216-242**

Ferrule; Sleeve for 0.75 mm<sup>2</sup> / 18 AWG; insulated; electro-tin plated; electrolytic copper; gastight crimped; acc. to DIN 46228, Part 4/09.90; gray



**Item No.: 216-243**

Ferrule; Sleeve for 1 mm<sup>2</sup> / AWG 18; insulated; electro-tin plated; electrolytic copper; gastight crimped; acc. to DIN 46228, Part 4/09.90; red



**Item No.: 216-244**

Ferrule; Sleeve for 1.5 mm<sup>2</sup> / AWG 16; insulated; electro-tin plated; electrolytic copper; gastight crimped; acc. to DIN 46228, Part 4/09.90; black

### 1.2.3.1 Ferrule



**Item No.: 216-246**

Ferrule; Sleeve for 2.5 mm<sup>2</sup> / AWG 14; insulated; electro-tin plated; electrolytic copper; gastight crimped; acc. to DIN 46228, Part 4/09.90; blue

**Item No.: 216-106**

Ferrule; Sleeve for 2.5 mm<sup>2</sup> / AWG 14; un-insulated; electro-tin plated; silver-colored

### 1.2.4 Installation

#### 1.2.4.1 Cover



**Item No.: 709-153**

Cover; Type 1; suitable for cover carrier, type 1; 1 m long; transparent

#### 1.2.4.2 Cover carrier



**Item No.: 709-167**

Cover carrier; Type 1; incl. fixing/retaining screws and knurled nut; suitable for 279 to 282 and 880 Series rail-mounted terminal blocks; suitable for 264 Series miniature rail-mounted terminal blocks; suitable for 270 Series sensor and actuator terminal blocks; gray

#### 1.2.4.3 Mounting accessories



**Item No.: 209-106**

Mounting carrier; for isolated mounting on DIN 35 rails; gray

**Item No.: 249-116**

Screwless end stop; 6 mm wide; for DIN-rail 35 x 15 and 35 x 7.5; gray

### 1.2.5 Insulation stop

#### 1.2.5.1 Insulation stop



**Item No.: 281-470**

Insulation stop; 0.08 - 0.2 mm<sup>2</sup> "s" (0.14 mm<sup>2</sup> "f-st"); 5 pieces/strip; white

**Item No.: 281-471**

Insulation stop; 0.25 - 0.5 mm<sup>2</sup>; 5 pieces/strip; light gray

**Item No.: 281-472**

Insulation stop; 0.75 - 1.5 mm<sup>2</sup>; 5 pieces/strip; dark gray

1.2.6 Jumper

1.2.6.1 Jumper



**Item No.: 281-490**  
Jumper; 10-way; insulated; gray



**Item No.: 281-482**  
Jumper; 2-way; insulated; gray



**Item No.: 281-492**  
Jumper; 2-way; insulated; gray



**Item No.: 281-483**  
Jumper; 3-way; insulated; gray



**Item No.: 281-485**  
Jumper; 5-way; insulated; gray



**Item No.: 281-402**  
Jumper; insulated; gray



**Item No.: 281-409**  
Jumper; insulated; gray



**Item No.: 281-422**  
Jumper; insulated; yellow-green



**Item No.: 781-452**  
Staggered jumper; from 1 to 2; insulated; gray



**Item No.: 781-453**  
Staggered jumper; from 1 to 3; insulated; gray



**Item No.: 781-454**  
Staggered jumper; from 1 to 4; insulated; gray



**Item No.: 781-455**  
Staggered jumper; from 1 to 5; insulated; gray



**Item No.: 781-456**  
Staggered jumper; from 1 to 6; insulated; gray



**Item No.: 283-414**  
Step-down jumper; from 283 to 281 series; insulated; gray



**Item No.: 284-414**  
Step-down jumper; from 284/282 to 281/280/279 series; insulated; gray



**Item No.: 709-110**  
Wire commoning chain; 2.5 mm<sup>2</sup>; insulated; black



**Item No.: 709-111**  
Wire commoning chain; 2.5 mm<sup>2</sup>; insulated; black



**Item No.: 709-112**  
Wire commoning chain; 2.5 mm<sup>2</sup>; insulated; black



**Item No.: 210-103**  
Wire commoning chain; insulated; black



**Item No.: 210-123**  
Wire commoning chain; insulated; blue

1.2.7 Marking

1.2.7.1 Group marker carrier



**Item No.: 209-140**  
Group marker carrier; gray



**Item No.: 209-141**  
Group marker carrier; gray



**Item No.: 209-142**  
Group marker carrier; gray



**Item No.: 249-105**  
Group marker carrier; gray

1.2.7.2 Marker



**Item No.: 793-5501/000-006**  
WMB marking card; as card; for terminal block width 5 - 17.5 mm; stretchable 5 - 5.2 mm; plain; snap-on type; blue



**Item No.: 793-5501/000-007**  
WMB marking card; as card; for terminal block width 5 - 17.5 mm; stretchable 5 - 5.2 mm; plain; snap-on type; gray



**Item No.: 793-5501/000-023**  
WMB marking card; as card; for terminal block width 5 - 17.5 mm; stretchable 5 - 5.2 mm; plain; snap-on type; green



**Item No.: 793-5501/000-017**  
WMB marking card; as card; for terminal block width 5 - 17.5 mm; stretchable 5 - 5.2 mm; plain; snap-on type; light green



**Item No.: 793-5501/000-012**  
WMB marking card; as card; for terminal block width 5 - 17.5 mm; stretchable 5 - 5.2 mm; plain; snap-on type; orange



**Item No.: 793-5501/000-005**  
WMB marking card; as card; for terminal block width 5 - 17.5 mm; stretchable 5 - 5.2 mm; plain; snap-on type; red



**Item No.: 793-5501/000-024**  
WMB marking card; as card; for terminal block width 5 - 17.5 mm; stretchable 5 - 5.2 mm; plain; snap-on type; violet



**Item No.: 793-5501**  
WMB marking card; as card; for terminal block width 5 - 17.5 mm; stretchable 5 - 5.2 mm; plain; snap-on type; white



**Item No.: 793-5501/000-002**  
WMB marking card; as card; for terminal block width 5 - 17.5 mm; stretchable 5 - 5.2 mm; plain; snap-on type; yellow



**Item No.: 793-501/000-006**  
WMB marking card; as card; not stretchable; plain; snap-on type; blue



**Item No.: 793-501/000-007**  
WMB marking card; as card; not stretchable; plain; snap-on type; gray



**Item No.: 793-501/000-023**  
WMB marking card; as card; not stretchable; plain; snap-on type; green



**Item No.: 793-501/000-017**  
WMB marking card; as card; not stretchable; plain; snap-on type; light green



**Item No.: 793-501/000-012**  
WMB marking card; as card; not stretchable; plain; snap-on type; orange



**Item No.: 793-501/000-005**  
WMB marking card; as card; not stretchable; plain; snap-on type; red



**Item No.: 793-501/000-024**  
WMB marking card; as card; not stretchable; plain; snap-on type; violet

1.2.7.2 Marker



**Item No.: 793-501**  
WMB marking card; as card; not stretchable; plain; snap-on type; white

**Item No.: 793-501/000-002**  
WMB marking card; as card; not stretchable; plain; snap-on type; yellow

**Item No.: 2009-115/000-006**  
WMB-Inline; for Smart Printer; 1500 pieces on roll; stretchable 5 - 5.2 mm; plain; snap-on type; blue

**Item No.: 2009-115/000-007**  
WMB-Inline; for Smart Printer; 1500 pieces on roll; stretchable 5 - 5.2 mm; plain; snap-on type; gray



**Item No.: 2009-115/000-023**  
WMB-Inline; for Smart Printer; 1500 pieces on roll; stretchable 5 - 5.2 mm; plain; snap-on type; green

**Item No.: 2009-115/000-017**  
WMB-Inline; for Smart Printer; 1500 pieces on roll; stretchable 5 - 5.2 mm; plain; snap-on type; light green

**Item No.: 2009-115/000-012**  
WMB-Inline; for Smart Printer; 1500 pieces on roll; stretchable 5 - 5.2 mm; plain; snap-on type; orange

**Item No.: 2009-115/000-024**  
WMB-Inline; for Smart Printer; 1500 pieces on roll; stretchable 5 - 5.2 mm; plain; snap-on type; violet



**Item No.: 2009-115**  
WMB-Inline; for Smart Printer; 1500 pieces on roll; stretchable 5 - 5.2 mm; plain; snap-on type; white

**Item No.: 2009-115/000-002**  
WMB-Inline; for Smart Printer; 1500 pieces on roll; stretchable 5 - 5.2 mm; plain; snap-on type; yellow

1.2.8 Protective warning marker

1.2.8.1 Cover



**Item No.: 281-415**  
Protective warning marker; for 5 terminal blocks; with high-voltage symbol, black; yellow

1.2.9 Push-in type wire jumper

1.2.9.1 Jumper



**Item No.: 249-126**  
Push-in type wire jumper; 0.75 mm<sup>2</sup>; insulated; 110 mm long; black

**Item No.: 249-123**  
Push-in type wire jumper; 0.75 mm<sup>2</sup>; insulated; 180 mm long; black

**Item No.: 249-127**  
Push-in type wire jumper; 0.75 mm<sup>2</sup>; insulated; 250 mm long; black

**Item No.: 249-125**  
Push-in type wire jumper; insulated; 60 mm long; black

1.2.10 Test and measurement

1.2.10.1 Testing accessories



**Item No.: 249-148**  
B-type spacer module; modular; e.g., for bridging commoned terminal blocks; gray

**Item No.: 249-147**  
B-type test plug module; modular; 2,50 mm<sup>2</sup>; gray

**Item No.: 249-145**  
L-type end module; modular; with rigid contact pin; End module; 2,50 mm<sup>2</sup>; gray

**Item No.: 249-146**  
L-type spacer module; modular; e.g., bridging commoned terminal blocks; gray



**Item No.: 249-144**  
L-type test plug module; modular; with spring-loaded contact pin; Center module; 2,50 mm<sup>2</sup>; gray

**Item No.: 281-419**  
Spacer module; modular; bridging commoned terminal blocks; gray

**Item No.: 280-404**  
Test plug adapter; 5 mm wide; for test plug (2.3 mm Ø); suitable for 1.5 mm<sup>2</sup> - 4 mm<sup>2</sup> tbs; gray

**Item No.: 209-170**  
Test plug adapter; 8.3 mm wide; for 4 mm Ø test plugs; suitable for 1.5 mm<sup>2</sup> - 10 mm<sup>2</sup> tbs; gray



**Item No.: 281-418**  
Test plug module; modular; suitable for all WAGO 281, 776, 777 and 781 series rail-mounted terminal blocks with jumper slots in the current bar; gray

**Item No.: 281-407**  
Test plug; 6 mm wide; Nominal current 24 A; for 0.08 mm<sup>2</sup> - 2.5 mm<sup>2</sup>; gray

1.2.11 Tool

1.2.11.1 Operating tool



**Item No.: 210-658**

Operating tool; Blade: 3.5 x 0.5 mm; with a partially insulated shaft; angled; short; multicoloured



**Item No.: 210-720**

Operating tool; Blade: 3.5 x 0.5 mm; with a partially insulated shaft; multicoloured



**Item No.: 210-657**

Operating tool; Blade: 3.5 x 0.5 mm; with a partially insulated shaft; short; multicoloured

Installation Notes

Installation

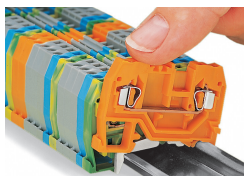

Snapping a terminal block onto the DIN-rail.

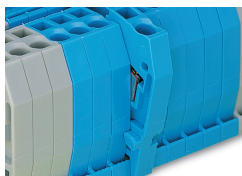

Quick assembly keys prevent reverse mounting.

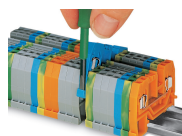

Removing a terminal block from the assembly.

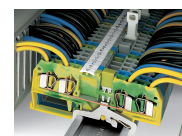

Steel DIN-rails are not suited for PEN (ground and N-conductor) applications per EN 60947-7-2 (VDE 0611, Part 3).

Conductor termination



**CAGE CLAMP® connection**  
Inserting a conductor.

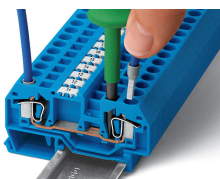

**CAGE CLAMP® connection**  
Inserting a conductor.  
With ferruled conductors, it is necessary to use a terminal block one size larger than the conductor's nominal cross-section.



Inserting insulation stops.

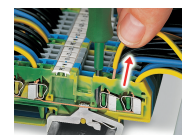

**CAGE CLAMP® connection**  
Removing a solid conductor.

**Commoning**

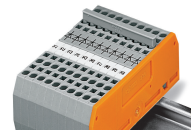
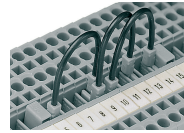
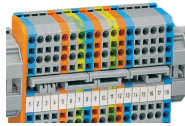

Commoning using an adjacent jumper. Push jumper down until fully inserted!

Staggered jumpers are suitable for sophisticated circuit requirements. Push jumpers down until fully inserted!

**Push-In Type Wire Jumpers**  
 When installing machines or control systems, it is often necessary to make an additional connection between two terminal blocks that are not next to each other on the rail. In such cases, WAGO's touch-proof, push-in type wire jumpers are the ideal solution.

These jumpers are compatible with the following rail-mount terminal blocks:  
 - 279 Series (1.5 mm<sup>2</sup>/16 AWG),  
 - 280/775/780 Series (2.5 mm<sup>2</sup>/14 AWG)  
 - 281/769/776/777/781 and 880 Series (4 mm<sup>2</sup>/12 AWG)

They are available in three conductor lengths (60, 110 and 250 mm), allowing up to 60 terminal blocks to be commoned depending on their width (see table on the right).

The 280/775/780 and 281/776/777/781 Series Terminal Blocks accept two wire jumpers, allowing the use of commoning chains. Furthermore, the 280/769/775/780/880 and 281/776/777/781 Series allow both wire jumper and adjacent jumper to be simultaneously plugged into a same terminal block.

Commoning using comb-style jumper bars: Push comb-style jumper bars down until fully inserted.

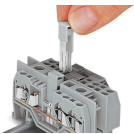

Commoning terminal blocks of different sizes via step-down jumpers.

**Testing**

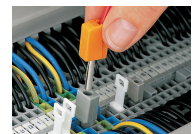
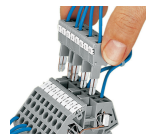
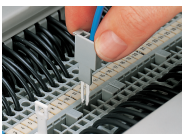

Testing with a test plug. Picture shows a test plug fitted with CAGE CLAMP®.

L-type test plug modules fitted with CAGE CLAMP®

B-type test plug modules fitted with CAGE CLAMP®

Testing with a test plug. Picture shows a test plug adapter (209-170).

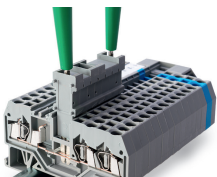

Test plug modules are directly plugged into the jumper contact slot of the current bar.

## Cover

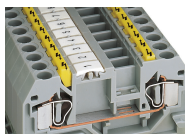

Protective warning markers inserted into the operating slots

## Marking

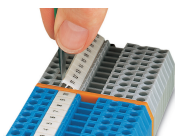

Labeling via WMB Multi Marking System.

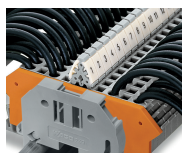

Terminal block marking with double marker carriers (209-128) Terminal blocks with side marking