

Data Sheet | Item Number: 769-211

2-conductor/2-pin carrier terminal block; with shield contact; for DIN-rail 35 x 15 and 35 x 7.5; 4 mm²; CAGE CLAMP®; 4,00 mm²; gray

<https://www.wago.com/769-211>

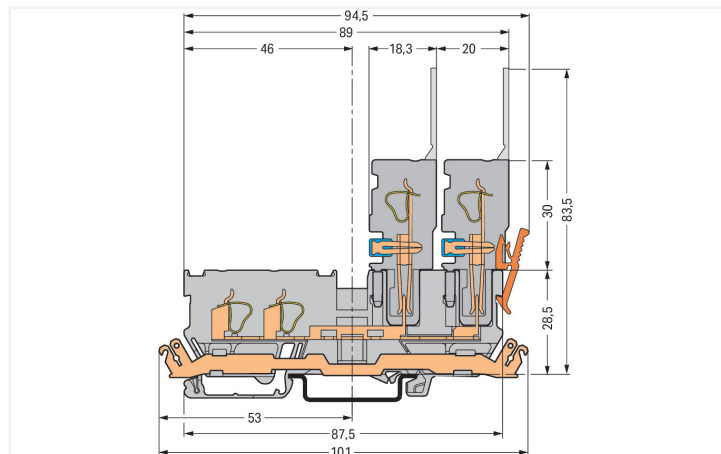

Color: ■ gray

Through terminal block, 769 Series, gray

This through terminal block (item number 769-211) provides hassle-free electrical installations. Ensure that the strip lengths are between 8 and 9 mm when connecting conductors to this through terminal block. Pluggable rail-mount terminal blocks are primarily found in switchgear units and control systems, most notably in railroad technology. These innovative systems combine the properties of rail-mount terminal blocks and connectors for a flexible and reliable wiring system. You also have the option of pre-assembling installations, which not only makes production but also installation, operation, and maintenance more efficient and cost-effective. The through terminal block also serves as a shield termination. This product features conductor terminals and utilizes CAGE CLAMP®. Our renowned universal connection known as CAGE CLAMP® is the industry standard when it comes to connection technology and electrical interconnections. This through terminal block is suitable for conductor cross sections ranging from 0.08 mm² to 4 mm².

This pluggable rail-mount terminal block is operated with an operating tool.

Notes

Safety Information

A separator plate (Item No. 209-191) or a 10 mm end stop (Item No. 249-117) must be placed at the end of a WAGO X-COM®-SYSTEM terminal strip.

Note

1-conductor angled female plugs cannot be used.

Electrical data

Ratings per

IEC/EN 60947-7-1

Overvoltage category	III	III	II
Pollution degree	3	2	2
Nominal voltage	250 V	-	-
Rated impulse withstand voltage	4 kV	-	-
Rated current	32 A	-	-

Power Loss

Power loss, per pole (potential)	1.024 W
Rated current I_N for power loss specification	32 A
Resistance value for specified, current-dependent power loss	0.001 Ω

General information

Wiring direction	Front-entry wiring
------------------	--------------------

Connection Data

Clamping units	2
Total number of potentials	1
Number of levels	1

Connection 1

Connection technology	CAGE CLAMP®
Number of connection points	2
Actuation type	Operating tool
Connectable conductor materials	Copper
Nominal cross-section	4 mm ² / 12 AWG
Solid conductor	0.08 ... 4 mm ² / 28 ... 12 AWG
Fine-stranded conductor	0.08 ... 4 mm ² / 28 ... 12 AWG
Strip length	8 ... 9 mm / 0.31 ... 0.35 inches
Wiring direction	Front-entry wiring

Connection 2

Number of connection points	1
-----------------------------	---

Physical data

Width	5 mm / 0.197 inches
Height	101 mm / 3.976 inches
Depth from upper-edge of DIN-rail	28.5 mm / 1.122 inches

Mechanical data

Design	horizontal type
Mounting type	DIN-35 rail
Marking level	Center marking

Material data

Note (material data)	Information on material specifications can be found here
Color	gray
Material group	I
Insulation material (main housing)	Polyamide (PA66)
Flammability class per UL94	V0
Fire load	0.173 MJ
Weight	13.1 g

Environmental requirements

Processing temperature	-35 ... +85 °C
Continuous operating temperature	-60 ... +105 °C

Commercial data

Product Group	18 (X-COM-System)
PU (SPU)	50 pcs
Packaging type	Box
Country of origin	DE
GTIN	4044918556071
Customs tariff number	85366990990

Product Classification

UNSPSC	39121410
eCl@ss 10.0	27-14-11-20
eCl@ss 9.0	27-14-11-20
ETIM 9.0	EC000897
ETIM 10.0	EC000897
ECCN	NO US CLASSIFICATION

Environmental Product Compliance

RoHS Compliance Status	Compliant, No Exemption
------------------------	-------------------------

Approvals / Certificates

General approvals



Approval	Standard	Certificate Name
CCA DEKRA Certification B.V.	EN 60947	NTR NL-7626
CSA CSA Group	C22.2	1101144
KEMA/KEUR DEKRA Certification B.V.	EN 60947	2190419.01
UL Underwriters Laboratories Inc.	UL 1059	E45172
UL Underwriters Laboratories Inc.	UL 1977	E 45171

Declarations of conformity and manufacturer's declarations



Approval	Standard	Certificate Name
EU-Declaration of Conformity WAGO GmbH & Co. KG	-	-
Railway WAGO GmbH & Co. KG	-	Z00004428.000

Approvals for marine applications



Approval	Standard	Certificate Name
ABS American Bureau of Shipping	EN 60947	24-0152298-PDA
BV Bureau Veritas S.A.	EN 60947	07436/G0 BV
DNV GL Det Norske Veritas, Germanischer Lloyd	-	TAE00001V2
PRS Polski Rejestr Statków	-	TE/1094/880590/23

Downloads

Environmental Product Compliance

Compliance Search			
Environmental Product Compliance 769-211			↓

Documentation

Bid Text			
769-211	19.02.2019	xml 3.30 KB	↓
769-211	02.10.2017	doc 24.50 KB	↓

CAD/CAE-Data

CAD data	
2D/3D Models 769-211	↓

CAE data	
EPLAN Data Portal 769-211	↓
WSCAD Universe 769-211	↓
ZUKEN Portal 769-211	↓

1 Compatible Products

1.1 System counterpart

1.1.1 Female connector/socket

<p>Item No.: 769-110/145-000 1-conductor female connector; CAGE CLAMP®; 4 mm²; Pin spacing 5 mm; 10-pole; coding finger; Centered locking levers; Strain relief plate; 4,00 mm²; gray</p>	<p>Item No.: 769-111/145-000 1-conductor female connector; CAGE CLAMP®; 4 mm²; Pin spacing 5 mm; 11-pole; coding finger; Centered locking levers; Strain relief plate; 4,00 mm²; gray</p>	<p>Item No.: 769-112/145-000 1-conductor female connector; CAGE CLAMP®; 4 mm²; Pin spacing 5 mm; 12-pole; coding finger; Centered locking levers; Strain relief plate; 4,00 mm²; gray</p>	<p>Item No.: 769-113/145-000 1-conductor female connector; CAGE CLAMP®; 4 mm²; Pin spacing 5 mm; 13-pole; coding finger; Centered locking levers; Strain relief plate; 4,00 mm²; gray</p>
<p>Item No.: 769-114/145-000 1-conductor female connector; CAGE CLAMP®; 4 mm²; Pin spacing 5 mm; 14-pole; coding finger; Centered locking levers; Strain relief plate; 4,00 mm²; gray</p>	<p>Item No.: 769-115/145-000 1-conductor female connector; CAGE CLAMP®; 4 mm²; Pin spacing 5 mm; 15-pole; coding finger; Centered locking levers; Strain relief plate; 4,00 mm²; gray</p>	<p>Item No.: 769-101 1-conductor female connector; CAGE CLAMP®; 4 mm²; Pin spacing 5 mm; 1-pole; coding finger; 4,00 mm²; gray</p>	<p>Item No.: 769-101/141-000 1-conductor female connector; CAGE CLAMP®; 4 mm²; Pin spacing 5 mm; 1-pole; coding finger; Centered locking levers; Strain relief plate; 4,00 mm²; gray</p>
<p>Item No.: 769-102/142-000 1-conductor female connector; CAGE CLAMP®; 4 mm²; Pin spacing 5 mm; 2-pole; coding finger; Centered locking levers; Strain relief plate; 4,00 mm²; gray</p>	<p>Item No.: 769-103/142-000 1-conductor female connector; CAGE CLAMP®; 4 mm²; Pin spacing 5 mm; 3-pole; coding finger; Centered locking levers; Strain relief plate; 4,00 mm²; gray</p>	<p>Item No.: 769-104/143-000 1-conductor female connector; CAGE CLAMP®; 4 mm²; Pin spacing 5 mm; 4-pole; coding finger; Centered locking levers; Strain relief plate; 4,00 mm²; gray</p>	<p>Item No.: 769-105/143-000 1-conductor female connector; CAGE CLAMP®; 4 mm²; Pin spacing 5 mm; 5-pole; coding finger; Centered locking levers; Strain relief plate; 4,00 mm²; gray</p>
<p>Item No.: 769-106/144-000 1-conductor female connector; CAGE CLAMP®; 4 mm²; Pin spacing 5 mm; 6-pole; coding finger; Centered locking levers; Strain relief plate; 4,00 mm²; gray</p>	<p>Item No.: 769-107/144-000 1-conductor female connector; CAGE CLAMP®; 4 mm²; Pin spacing 5 mm; 7-pole; coding finger; Centered locking levers; Strain relief plate; 4,00 mm²; gray</p>	<p>Item No.: 769-108/144-000 1-conductor female connector; CAGE CLAMP®; 4 mm²; Pin spacing 5 mm; 8-pole; coding finger; Centered locking levers; Strain relief plate; 4,00 mm²; gray</p>	<p>Item No.: 769-109/144-000 1-conductor female connector; CAGE CLAMP®; 4 mm²; Pin spacing 5 mm; 9-pole; coding finger; Centered locking levers; Strain relief plate; 4,00 mm²; gray</p>

1.1.1 Female connector/socket



Item No.: 769-121
 2-conductor female connector; CAGE CLAMP®; 4 mm²; Pin spacing 5 mm; 1-pole; coding finger; 4,00 mm²; gray

1.2 Required Accessories

1.2.1 End plate

1.2.1.1 End plate



Item No.: 769-303
 End and intermediate plate; 1.1 mm thick; gray

Item No.: 769-304
 End and intermediate plate; 1.1 mm thick; orange

1.3 Optional Accessories

1.3.1 Coding

1.3.1.1 Coding



Item No.: 769-435
 Coding pin; for coding of female plugs; for carrier terminal blocks / male connectors; orange

1.3.2 Cover

1.3.2.1 Cover



Item No.: 769-438
 Pin cover; with marker slot for miniature WSB; gray

Item No.: 769-439
 Pin cover; with marker slot for miniature WSB; orange

1.3.3 DIN-rail

1.3.3.1 Mounting accessories



Item No.: 210-196
 Aluminum carrier rail; 35 x 8.2 mm; 1.6 mm thick; 2 m long; unslotted; similar to EN 60715; silver-colored



Item No.: 210-198
 Copper carrier rail; 35 x 15 mm; 2.3 mm thick; 2 m long; unslotted; according to EN 60715; copper-colored



Item No.: 210-508
 Steel carrier rail; 35 x 15 mm; 1.5 mm thick; 2 m long; slotted; galvanized; similar to EN 60715; silver-colored



Item No.: 210-197
 Steel carrier rail; 35 x 15 mm; 1.5 mm thick; 2 m long; slotted; similar to EN 60715; silver-colored



Item No.: 210-506
 Steel carrier rail; 35 x 15 mm; 1.5 mm thick; 2 m long; unslotted; galvanized; similar to EN 60715; silver-colored



Item No.: 210-114
 Steel carrier rail; 35 x 15 mm; 1.5 mm thick; 2 m long; unslotted; similar to EN 60715; silver-colored



Item No.: 210-118
 Steel carrier rail; 35 x 15 mm; 2.3 mm thick; 2 m long; unslotted; according to EN 60715; silver-colored



Item No.: 210-115
 Steel carrier rail; 35 x 7.5 mm; 1 mm thick; 2 m long; slotted; according to EN 60715; "Hole width 18 mm; silver-colored

1.3.3.1 Mounting accessories



Item No.: 210-112
Steel carrier rail; 35 x 7.5 mm; 1 mm thick; 2 m long; slotted; according to EN 60715; "Hole width 25 mm; silver-colored



Item No.: 210-504
Steel carrier rail; 35 x 7.5 mm; 1 mm thick; 2 m long; slotted; galvanized; according to EN 60715; silver-colored



Item No.: 210-113
Steel carrier rail; 35 x 7.5 mm; 1 mm thick; 2 m long; unslotted; according to EN 60715; silver-colored



Item No.: 210-505
Steel carrier rail; 35 x 7.5 mm; 1 mm thick; 2 m long; unslotted; galvanized; according to EN 60715; silver-colored

1.3.4 Ferrule

1.3.4.1 Ferrule



Item No.: 216-301
Ferrule; Sleeve for 0.25 mm² / AWG 24; insulated; electro-tin plated; yellow



Item No.: 216-302
Ferrule; Sleeve for 0.34 mm² / 22 AWG; insulated; electro-tin plated; light turquoise



Item No.: 216-201
Ferrule; Sleeve for 0.5 mm² / 20 AWG; insulated; electro-tin plated; electrolytic copper; acc. to DIN 46228, Part 4/09.90; white



Item No.: 216-101
Ferrule; Sleeve for 0.5 mm² / AWG 22; un-insulated; electro-tin plated; silver-colored



Item No.: 216-202
Ferrule; Sleeve for 0.75 mm² / 18 AWG; insulated; electro-tin plated; gray



Item No.: 216-102
Ferrule; Sleeve for 0.75 mm² / AWG 20; un-insulated; electro-tin plated; silver-colored



Item No.: 216-203
Ferrule; Sleeve for 1 mm² / AWG 18; insulated; electro-tin plated; red



Item No.: 216-103
Ferrule; Sleeve for 1 mm² / AWG 18; un-insulated; electro-tin plated



Item No.: 216-204
Ferrule; Sleeve for 1.5 mm² / AWG 16; insulated; electro-tin plated; black



Item No.: 216-104
Ferrule; Sleeve for 1.5 mm² / AWG 16; un-insulated; electro-tin plated; silver-colored



Item No.: 216-206
Ferrule; Sleeve for 2.5 mm² / AWG 14; insulated; electro-tin plated; blue

1.3.5 Installation

1.3.5.1 Mounting accessories



Item No.: 209-106
Mounting carrier; for isolated mounting on DIN 35 rails; gray



Item No.: 249-116
Screwless end stop; 6 mm wide; for DIN-rail 35 x 15 and 35 x 7.5; gray

1.3.6 Insulation stop

1.3.6.1 Insulation stop



Item No.: 769-470
Insulation stop; 0.08 - 0.2 mm² "s" (0.14 mm² "f-st"); 5 pieces/strip; white



Item No.: 769-471
Insulation stop; 0.25 - 0.5 mm²; 5 pieces/strip; light gray



Item No.: 769-472
Insulation stop; 0.75 - 1 mm²; 5 pieces/strip; dark gray

1.3.7 Jumper

1.3.7.1 Jumper



Item No.: 280-402
Jumper; insulated; gray



Item No.: 280-409
Jumper; insulated; gray



Item No.: 780-452
Staggered jumper; from 1 to 2; insulated; gray



Item No.: 780-453
Staggered jumper; from 1 to 3; insulated; gray



Item No.: 780-454
Staggered jumper; from 1 to 4; insulated; gray



Item No.: 780-455
Staggered jumper; from 1 to 5; insulated; gray



Item No.: 780-456
Staggered jumper; from 1 to 6; insulated; gray



Item No.: 780-457
Staggered jumper; from 1 to 7; insulated; gray



Item No.: 780-458
Staggered jumper; from 1 to 8; insulated; gray

1.3.8 Marking

1.3.8.1 Marker



Item No.: 2009-145
Mini-WSB Inline; for Smart Printer; 1700 pieces on roll; stretchable 5 - 5.2 mm; plain; snap-on type; white



Item No.: 248-501
Mini-WSB marking card; as card; not stretchable; plain; snap-on type; white

1.3.9 Protective warning marker

1.3.9.1 Cover



Item No.: 280-415
Protective warning marker; for 5 terminal blocks; with high-voltage symbol, black; yellow

1.3.10 Push-in type wire jumper

1.3.10.1 Jumper



Item No.: 249-126
Push-in type wire jumper; 0.75 mm²; insulated; 110 mm long; black



Item No.: 249-123
Push-in type wire jumper; 0.75 mm²; insulated; 180 mm long; black



Item No.: 249-127
Push-in type wire jumper; 0.75 mm²; insulated; 250 mm long; black



Item No.: 249-125
Push-in type wire jumper; insulated; 60 mm long; black

1.3.11 Test and measurement

1.3.11.1 Testing accessories



Item No.: 280-419

Spacer module; modular; bridging commoned terminal blocks; gray



Item No.: 280-404

Test plug adapter; 5 mm wide; for test plug (2.3 mm Ø); suitable for 1.5 mm² - 4 mm² tbs; gray



Item No.: 280-418

Test plug module; modular; suitable for all WAGO 280 and 780 Series rail-mounted terminal blocks with jumper slots in the current bar; gray



Item No.: 210-136

Test plug; 2 mm Ø; with 500 mm cable; red

1.3.12 Tool

1.3.12.1 Operating tool



Item No.: 210-720

Operating tool; Blade: 3.5 x 0.5 mm; with a partially insulated shaft; multicoloured

Installation Notes

Installation

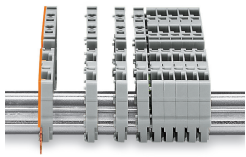

Snap individual carrier terminal blocks onto the DIN-rail and slide together.

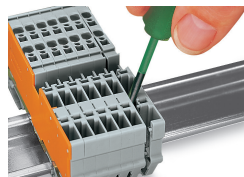

Open the assembly by laterally sliding a block via operating tool and remove terminal block via release lever.

Conductor termination

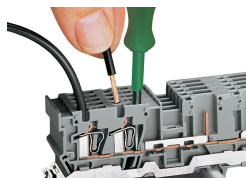

CAGE CLAMP® connection

Carrier terminal block: Insert/remove conductor via operating tool (3.5 x 0.5 mm blade).

Commoning

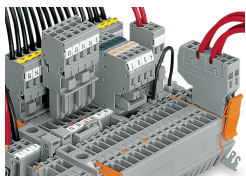

Commoning with adjacent or staggered jumpers. Push jumpers down until fully inserted.

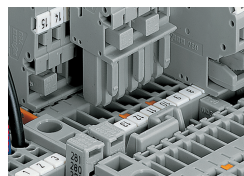

Commoning carrier terminal blocks via staggered jumpers.

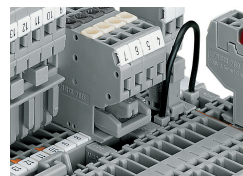

Commoning a 2-conductor female plug via staggered jumper and carrier terminal blocks via adjacent jumpers.

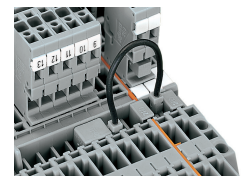

Commoning carrier terminal blocks via push-in type wire jumpers or adjacent jumpers – even over an intermediate plate.

