

Data Sheet | Item Number: 281-905

2-conductor through terminal block; 4 mm²; center marking; for DIN-rail 35 x 15 and 35 x 7.5; CAGE CLAMP®; 4,00 mm²; black

<https://www.wago.com/281-905>

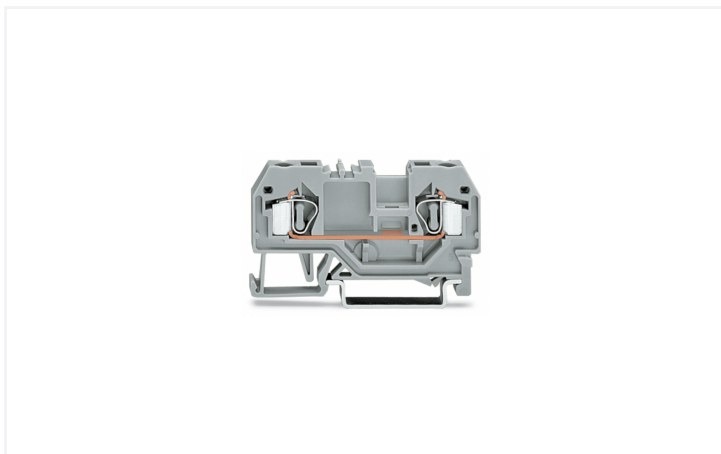

Color: ■ black

Similar to illustration

Similar to illustration

Through terminal block, 281 Series, CAGE CLAMP®

Our through terminal block (item number 281-905) ensures effortless electrical installations. Ensure that the strip lengths are between 9 and 10 mm when connecting conductors to this through terminal block. Whether in industrial or building applications, our rail-mount through terminal blocks are the perfect solution to quickly and securely connect electrical conductors. Depending on the model, you can use them for either typical through-wiring or potential distribution. This product features conductor terminals and utilizes CAGE CLAMP®. Our CAGE CLAMP® connection offers a safe and maintenance-free way to connect all types of conductors. You do not need to prepare the conductor in any way, such as crimping ferrules. This through terminal block is suitable for conductor cross sections ranging from 0.08 mm² to 4 mm².

An operating tool is used to operate this through rail-mount terminal block.

Electrical data

Ratings per	IEC/EN 60947-7-1		
Overvoltage category	III	III	II
Pollution degree	3	2	2
Nominal voltage	800 V	-	-
Rated impulse withstand voltage	8 kV	-	-
Rated current	32 A	-	-

Power Loss

Power loss, per pole (potential)	1.024 W
Rated current I_N for power loss specification	32 A
Resistance value for specified, current-dependent power loss	0.001 Ω

General information

Wiring direction	Front-entry wiring
------------------	--------------------

Connection Data

Clamping units	2
Total number of potentials	1
Number of levels	1

Connection 1

Connection technology	CAGE CLAMP®
Actuation type	Operating tool
Connectable conductor materials	Copper Aluminum

Connectable conductor materials (note) **Terminating Aluminum Conductors**
WAGO Spring-Clamp Terminal Blocks are suitable for solid aluminum conductors up to 4 mm²/12 AWG if WAGO "Alu-Plus" Contact Paste [249-130](#) is used for termination.

"Alu-Plus" Contact Paste Advantages:

- Automatically destroys the oxide film during clamping.
- Prevents fresh oxidation at the clamping point.
- Prevents electrolytic corrosion between aluminum and copper conductors (in the same terminal block).
- Provides long-term protection against corrosion.

Using terminal blocks with CAGE CLAMP® Spring Pressure Connection Technology, **aluminum conductors must first be cleaned with a blade** and then immediately inserted into the clamping units filled with "Alu-Plus" contact paste.

It is also possible to apply WAGO "Alu-Plus" **additionally** on the whole surface of the aluminum conductor before termination.

Please note that the nominal currents must be adapted to the reduced conductivity of the aluminum conductors::
2.5 mm² = 16 A
4 mm² = 22 A

Solid conductor	0.08 ... 4 mm ² / 28 ... 12 AWG
Fine-stranded conductor	0.08 ... 4 mm ² / 28 ... 12 AWG
Strip length	9 ... 10 mm / 0.35 ... 0.39 inches
Wiring direction	Front-entry wiring

Physical data

Width	6 mm / 0.236 inches
Height	59 mm / 2.323 inches
Depth from upper-edge of DIN-rail	29 mm / 1.142 inches

Mechanical data

Design	horizontal type
Mounting type	DIN-35 rail
Marking level	Center marking

Material data

Note (material data)	Information on material specifications can be found here
Color	black
Material group	I
Insulation material (main housing)	Polyamide (PA66)
Flammability class per UL94	V0
Fire load	0.145 MJ
Weight	7.9 g

Environmental requirements

Processing temperature	-35 ... +85 °C
Continuous operating temperature	-60 ... +105 °C

Commercial data

PU (SPU)	50 pcs
Packaging type	Box
Country of origin	PL
GTIN	4044918485135
Customs tariff number	85369010000

Product Classification

UNSPSC	39121410
eCl@ss 10.0	27-14-11-20
eCl@ss 9.0	27-14-11-20
ETIM 9.0	EC000897
ETIM 10.0	EC000897
ECCN	NO US CLASSIFICATION

Environmental Product Compliance

RoHS Compliance Status	Compliant, No Exemption
------------------------	-------------------------

Approvals / Certificates

General approvals



Approval	Standard	Certificate Name
CSA CSA Group	C22.2	1505034
KEMA/KEUR DEKRA Certification B.V.	EN 60947	71-107288
UL UL International Germany GmbH	UL 1059	E45172

Declarations of conformity and manufacturer's declarations

Approval	Standard	Certificate Name
EU-Declaration of Confor- mity WAGO GmbH & Co. KG	-	-

Approvals for marine applications



Approval	Standard	Certificate Name
ABS American Bureau of Ship- ping	-	24-0152298-PDA
BV Bureau Veritas S.A.	EN 60947	07436/G0 BV
DNV GL Det Norske Veritas, Ger- manischer Lloyd	-	TAE00001V2
PRS Polski Rejestr Statków	-	TE/1094/880590/23

Downloads

Environmental Product Compliance

Compliance Search
Environmental Product Compliance 281-905 ↓

Documentation

Bid Text			
281-905	19.02.2019	xml 3.18 KB	↓
281-905	28.02.2017	doc 24.00 KB	↓

CAD/CAE-Data

CAD data
2D/3D Models 281-905 ↓

CAE data
EPLAN Data Portal 281-905 ↓
WSCAD Universe 281-905 ↓
ZUKEN Portal 281-905 ↓

1 Compatible Products

1.1 Required Accessories

1.1.1 End plate

1.1.1.1 End plate



Item No.: 281-328

End and intermediate plate; 2.5 mm thick; gray

Item No.: 281-329

End and intermediate plate; 2.5 mm thick; orange

Item No.: 281-330

Separator plate; 2 mm thick; oversized; gray

Item No.: 281-331

Separator plate; 2 mm thick; oversized; orange

1.2 Optional Accessories

1.2.1 DIN-rail

1.2.1.1 Mounting accessories



Item No.: 210-196

Aluminum carrier rail; 35 x 8.2 mm; 1.6 mm thick; 2 m long; unslotted; similar to EN 60715; silver-colored



Item No.: 210-198

Copper carrier rail; 35 x 15 mm; 2.3 mm thick; 2 m long; unslotted; according to EN 60715; copper-colored



Item No.: 210-508

Steel carrier rail; 35 x 15 mm; 1.5 mm thick; 2 m long; slotted; galvanized; similar to EN 60715; silver-colored



Item No.: 210-197

Steel carrier rail; 35 x 15 mm; 1.5 mm thick; 2 m long; slotted; similar to EN 60715; silver-colored



Item No.: 210-506

Steel carrier rail; 35 x 15 mm; 1.5 mm thick; 2 m long; unslotted; galvanized; similar to EN 60715; silver-colored



Item No.: 210-114

Steel carrier rail; 35 x 15 mm; 1.5 mm thick; 2 m long; unslotted; similar to EN 60715; silver-colored



Item No.: 210-118

Steel carrier rail; 35 x 15 mm; 2.3 mm thick; 2 m long; unslotted; according to EN 60715; silver-colored



Item No.: 210-115

Steel carrier rail; 35 x 7.5 mm; 1 mm thick; 2 m long; slotted; according to EN 60715; "Hole width 18 mm; silver-colored



Item No.: 210-112

Steel carrier rail; 35 x 7.5 mm; 1 mm thick; 2 m long; slotted; according to EN 60715; "Hole width 25 mm; silver-colored



Item No.: 210-504

Steel carrier rail; 35 x 7.5 mm; 1 mm thick; 2 m long; slotted; galvanized; according to EN 60715; silver-colored



Item No.: 210-113

Steel carrier rail; 35 x 7.5 mm; 1 mm thick; 2 m long; unslotted; according to EN 60715; silver-colored



Item No.: 210-505

Steel carrier rail; 35 x 7.5 mm; 1 mm thick; 2 m long; unslotted; galvanized; according to EN 60715; silver-colored

1.2.2 End plate

1.2.2.1 End plate



Item No.: 284-334

Step-down cover plate; 1 mm thick; for 2-, 3- and 4-conductor terminal blocks; gray



Item No.: 284-344

Step-down cover plate; 1 mm thick; for 2-, 3- and 4-conductor terminal blocks; orange

1.2.3 Ferrule

1.2.3.1 Ferrule



Item No.: 216-241

Ferrule; Sleeve for 0.5 mm² / 20 AWG; insulated; electro-tin plated; electrolytic copper; gastight crimped; acc. to DIN 46228, Part 4/09.90; white



Item No.: 216-242

Ferrule; Sleeve for 0.75 mm² / 18 AWG; insulated; electro-tin plated; electrolytic copper; gastight crimped; acc. to DIN 46228, Part 4/09.90; gray



Item No.: 216-243

Ferrule; Sleeve for 1 mm² / AWG 18; insulated; electro-tin plated; electrolytic copper; gastight crimped; acc. to DIN 46228, Part 4/09.90; red



Item No.: 216-244

Ferrule; Sleeve for 1.5 mm² / AWG 16; insulated; electro-tin plated; electrolytic copper; gastight crimped; acc. to DIN 46228, Part 4/09.90; black

1.2.3.1 Ferrule



Item No.: 216-246

Ferrule; Sleeve for 2.5 mm² / AWG 14; insulated; electro-tin plated; electrolytic copper; gastight crimped; acc. to DIN 46228, Part 4/09.90; blue

Item No.: 216-106

Ferrule; Sleeve for 2.5 mm² / AWG 14; un-insulated; electro-tin plated; silver-colored

1.2.4 Installation

1.2.4.1 Cover



Item No.: 709-153

Cover; Type 1; suitable for cover carrier, type 1; 1 m long; transparent

1.2.4.2 Cover carrier



Item No.: 709-167

Cover carrier; Type 1; incl. fixing/retaining screws and knurled nut; suitable for 279 to 282 and 880 Series rail-mounted terminal blocks; suitable for 264 Series miniature rail-mounted terminal blocks; suitable for 270 Series sensor and actuator terminal blocks; gray

1.2.4.3 Mounting accessories



Item No.: 209-106

Mounting carrier; for isolated mounting on DIN 35 rails; gray

Item No.: 249-116

Screwless end stop; 6 mm wide; for DIN-rail 35 x 15 and 35 x 7.5; gray

1.2.5 Insulation stop

1.2.5.1 Insulation stop



Item No.: 281-470

Insulation stop; 0.08 - 0.2 mm² "s" (0.14 mm² "f-st"); 5 pieces/strip; white

Item No.: 281-471

Insulation stop; 0.25 - 0.5 mm²; 5 pieces/strip; light gray

Item No.: 281-472

Insulation stop; 0.75 - 1.5 mm²; 5 pieces/strip; dark gray

1.2.6 Jumper

1.2.6.1 Jumper



Item No.: 281-490
Jumper; 10-way; insulated; gray



Item No.: 281-482
Jumper; 2-way; insulated; gray



Item No.: 281-492
Jumper; 2-way; insulated; gray



Item No.: 281-483
Jumper; 3-way; insulated; gray



Item No.: 281-485
Jumper; 5-way; insulated; gray



Item No.: 281-402
Jumper; insulated; gray



Item No.: 281-409
Jumper; insulated; gray



Item No.: 281-422
Jumper; insulated; yellow-green



Item No.: 781-452
Staggered jumper; from 1 to 2; insulated; gray



Item No.: 781-453
Staggered jumper; from 1 to 3; insulated; gray



Item No.: 781-454
Staggered jumper; from 1 to 4; insulated; gray



Item No.: 781-455
Staggered jumper; from 1 to 5; insulated; gray



Item No.: 781-456
Staggered jumper; from 1 to 6; insulated; gray



Item No.: 283-414
Step-down jumper; from 283 to 281 series; insulated; gray



Item No.: 284-414
Step-down jumper; from 284/282 to 281/280/279 series; insulated; gray



Item No.: 709-110
Wire commoning chain; 2.5 mm²; insulated; black



Item No.: 709-111
Wire commoning chain; 2.5 mm²; insulated; black



Item No.: 709-112
Wire commoning chain; 2.5 mm²; insulated; black



Item No.: 210-103
Wire commoning chain; insulated; black



Item No.: 210-123
Wire commoning chain; insulated; blue

1.2.7 Marking

1.2.7.1 Group marker carrier



Item No.: 209-140
Group marker carrier; gray



Item No.: 209-141
Group marker carrier; gray



Item No.: 209-142
Group marker carrier; gray



Item No.: 249-105
Group marker carrier; gray

1.2.7.2 Marker



Item No.: 793-5501/000-006
WMB marking card; as card; for terminal block width 5 - 17.5 mm; stretchable 5 - 5.2 mm; plain; snap-on type; blue



Item No.: 793-5501/000-007
WMB marking card; as card; for terminal block width 5 - 17.5 mm; stretchable 5 - 5.2 mm; plain; snap-on type; gray



Item No.: 793-5501/000-023
WMB marking card; as card; for terminal block width 5 - 17.5 mm; stretchable 5 - 5.2 mm; plain; snap-on type; green



Item No.: 793-5501/000-017
WMB marking card; as card; for terminal block width 5 - 17.5 mm; stretchable 5 - 5.2 mm; plain; snap-on type; light green



Item No.: 793-5501/000-012
WMB marking card; as card; for terminal block width 5 - 17.5 mm; stretchable 5 - 5.2 mm; plain; snap-on type; orange



Item No.: 793-5501/000-005
WMB marking card; as card; for terminal block width 5 - 17.5 mm; stretchable 5 - 5.2 mm; plain; snap-on type; red



Item No.: 793-5501/000-024
WMB marking card; as card; for terminal block width 5 - 17.5 mm; stretchable 5 - 5.2 mm; plain; snap-on type; violet



Item No.: 793-5501
WMB marking card; as card; for terminal block width 5 - 17.5 mm; stretchable 5 - 5.2 mm; plain; snap-on type; white



Item No.: 793-5501/000-002
WMB marking card; as card; for terminal block width 5 - 17.5 mm; stretchable 5 - 5.2 mm; plain; snap-on type; yellow



Item No.: 793-501/000-006
WMB marking card; as card; not stretchable; plain; snap-on type; blue



Item No.: 793-501/000-007
WMB marking card; as card; not stretchable; plain; snap-on type; gray



Item No.: 793-501/000-023
WMB marking card; as card; not stretchable; plain; snap-on type; green



Item No.: 793-501/000-017
WMB marking card; as card; not stretchable; plain; snap-on type; light green



Item No.: 793-501/000-012
WMB marking card; as card; not stretchable; plain; snap-on type; orange



Item No.: 793-501/000-005
WMB marking card; as card; not stretchable; plain; snap-on type; red



Item No.: 793-501/000-024
WMB marking card; as card; not stretchable; plain; snap-on type; violet

1.2.7.2 Marker



Item No.: 793-501

WMB marking card; as card; not stretchable; plain; snap-on type; white

Item No.: 793-501/000-002

WMB marking card; as card; not stretchable; plain; snap-on type; yellow

Item No.: 2009-115/000-006

WMB-Inline; for Smart Printer; 1500 pieces on roll; stretchable 5 - 5.2 mm; plain; snap-on type; blue

Item No.: 2009-115/000-007

WMB-Inline; for Smart Printer; 1500 pieces on roll; stretchable 5 - 5.2 mm; plain; snap-on type; gray



Item No.: 2009-115/000-023

WMB-Inline; for Smart Printer; 1500 pieces on roll; stretchable 5 - 5.2 mm; plain; snap-on type; green

Item No.: 2009-115/000-017

WMB-Inline; for Smart Printer; 1500 pieces on roll; stretchable 5 - 5.2 mm; plain; snap-on type; light green

Item No.: 2009-115/000-012

WMB-Inline; for Smart Printer; 1500 pieces on roll; stretchable 5 - 5.2 mm; plain; snap-on type; orange

Item No.: 2009-115/000-024

WMB-Inline; for Smart Printer; 1500 pieces on roll; stretchable 5 - 5.2 mm; plain; snap-on type; violet



Item No.: 2009-115

WMB-Inline; for Smart Printer; 1500 pieces on roll; stretchable 5 - 5.2 mm; plain; snap-on type; white

Item No.: 2009-115/000-002

WMB-Inline; for Smart Printer; 1500 pieces on roll; stretchable 5 - 5.2 mm; plain; snap-on type; yellow

1.2.8 Protective warning marker

1.2.8.1 Cover



Item No.: 281-415

Protective warning marker; for 5 terminal blocks; with high-voltage symbol, black; yellow

1.2.9 Push-in type wire jumper

1.2.9.1 Jumper



Item No.: 249-126

Push-in type wire jumper; 0.75 mm²; insulated; 110 mm long; black

Item No.: 249-123

Push-in type wire jumper; 0.75 mm²; insulated; 180 mm long; black

Item No.: 249-127

Push-in type wire jumper; 0.75 mm²; insulated; 250 mm long; black

Item No.: 249-125

Push-in type wire jumper; insulated; 60 mm long; black

1.2.10 Test and measurement

1.2.10.1 Testing accessories



Item No.: 249-148

B-type spacer module; modular; e.g., for bridging commoned terminal blocks; gray

Item No.: 249-147

B-type test plug module; modular; 2,50 mm²; gray

Item No.: 249-145

L-type end module; modular; with rigid contact pin; End module; 2,50 mm²; gray

Item No.: 249-146

L-type spacer module; modular; e.g., bridging commoned terminal blocks; gray



Item No.: 249-144

L-type test plug module; modular; with spring-loaded contact pin; Center module; 2,50 mm²; gray

Item No.: 281-419

Spacer module; modular; bridging commoned terminal blocks; gray

Item No.: 280-404

Test plug adapter; 5 mm wide; for test plug (2.3 mm Ø); suitable for 1.5 mm² - 4 mm² tbs; gray

Item No.: 209-170

Test plug adapter; 8.3 mm wide; for 4 mm Ø test plugs; suitable for 1.5 mm² - 10 mm² tbs; gray



Item No.: 281-418

Test plug module; modular; suitable for all WAGO 281, 776, 777 and 781 series rail-mounted terminal blocks with jumper slots in the current bar; gray

Item No.: 281-407

Test plug; 6 mm wide; Nominal current 24 A; for 0.08 mm² - 2.5 mm²; gray

1.2.11 Tool

1.2.11.1 Operating tool



Item No.: 210-658

Operating tool; Blade: 3.5 x 0.5 mm; with a partially insulated shaft; angled; short; multicoloured



Item No.: 210-720

Operating tool; Blade: 3.5 x 0.5 mm; with a partially insulated shaft; multicoloured



Item No.: 210-657

Operating tool; Blade: 3.5 x 0.5 mm; with a partially insulated shaft; short; multicoloured

Installation Notes

Installation

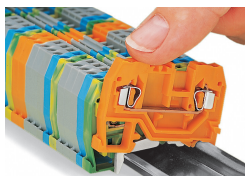

Snapping a terminal block onto the DIN-rail.

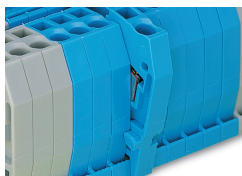

Quick assembly keys prevent reverse mounting.

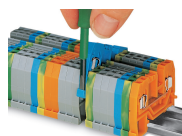

Removing a terminal block from the assembly.

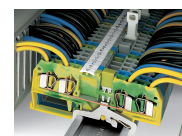

Steel DIN-rails are not suited for PEN (ground and N-conductor) applications per EN 60947-7-2 (VDE 0611, Part 3).

Conductor termination

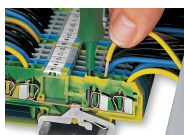

CAGE CLAMP® connection
Inserting a conductor.

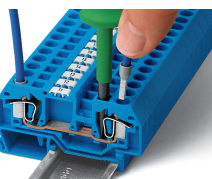

CAGE CLAMP® connection
Inserting a conductor.
With ferruled conductors, it is necessary to use a terminal block one size larger than the conductor's nominal cross-section.



Inserting insulation stops.

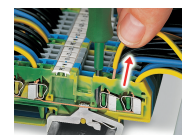

CAGE CLAMP® connection
Removing a solid conductor.

Commoning

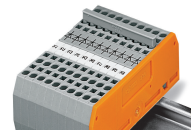
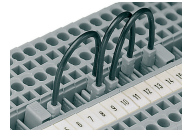
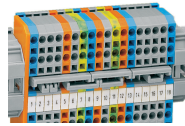

Commoning using an adjacent jumper. Push jumper down until fully inserted!

Staggered jumpers are suitable for sophisticated circuit requirements. Push jumpers down until fully inserted!

Push-In Type Wire Jumpers
 When installing machines or control systems, it is often necessary to make an additional connection between two terminal blocks that are not next to each other on the rail. In such cases, WAGO's touch-proof, push-in type wire jumpers are the ideal solution.

These jumpers are compatible with the following rail-mount terminal blocks:
 - 279 Series (1.5 mm²/16 AWG),
 - 280/775/780 Series (2.5 mm²/14 AWG)
 - 281/769/776/777/781 and 880 Series (4 mm²/12 AWG)

They are available in three conductor lengths (60, 110 and 250 mm), allowing up to 60 terminal blocks to be commoned depending on their width (see table on the right).

The 280/775/780 and 281/776/777/781 Series Terminal Blocks accept two wire jumpers, allowing the use of commoning chains. Furthermore, the 280/769/775/780/880 and 281/776/777/781 Series allow both wire jumper and adjacent jumper to be simultaneously plugged into a same terminal block.

Commoning using comb-style jumper bars: Push comb-style jumper bars down until fully inserted.



Commoning terminal blocks of different sizes via step-down jumpers.

Testing

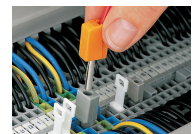
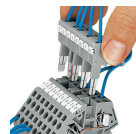
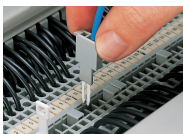

Testing with a test plug. Picture shows a test plug fitted with CAGE CLAMP®.

L-type test plug modules fitted with CAGE CLAMP®

B-type test plug modules fitted with CAGE CLAMP®

Testing with a test plug. Picture shows a test plug adapter (209-170).

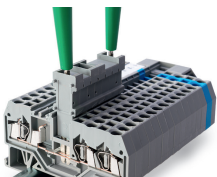

Test plug modules are directly plugged into the jumper contact slot of the current bar.

Cover

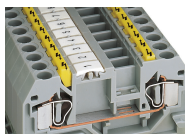

Protective warning markers inserted into the operating slots

Marking

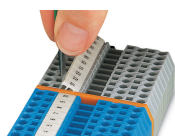

Labeling via WMB Multi Marking System.

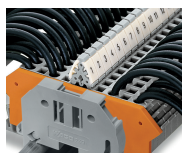

Terminal block marking with double marker carriers (209-128) Terminal blocks with side marking