

Installation and operating manual

SHK 20-200

Indoor module for air to water
split systems

EKSPERTER I VARME OG VARMT VAND



METRO THERM

07-02-2024
31573

List of content

1 Important information	4	7 Commissioning and adjusting	41
SHK - Safety information	4	Preparations	41
METROAIR L - SAFETY INFORMATION	6	Filling and venting	41
		Circulation pump	42
2 Delivery and handling	14	Commissioning	42
Available models	14	Start Guide	42
Compatibility	14	Overflow valve	43
Transport	14		
Assembly	14	8 Control - Introduction	44
Installation location	15	Display unit	44
Removing the cover	15	Menu system	45
Supplied components	15		
		9 Control	47
3 Design of the indoor unit	16	Start guide	50
SHK 20-200	16	Control - Menus	53
		Menu 1 - INDOOR CLIMATE	53
4 Pipe connections	18	Menu 2 - HOT WATER	62
General information	18	Menu 3 - INFO	65
System diagram	19	Menu 4 - MY SYSTEM	67
Pipe connections	23	Cooling settings	77
Docking the indoor unit	24	Menu 5 - SERVICE	78
Connection options	28		
DHW circulation	30	10 Service	88
		Service actions	88
5 METROAIR L outdoor unit	31		
Transport and storage	31	11 Disturbances in comfort	92
Assembly	31	Troubleshooting	92
Lift from the street to the set up location	31	Additional heating only	93
Lift from the pallet to final positioning	32		
Scrapping	32	12 Accessories	94
Condensation water drain	32	Connecting the KVR accessory	95
Recommended for leading off		Connecting an additional heat source	96
condensation water	32	Connecting the expansion card	97
Maintenance of METROAIR L	33	Connection of an additional GP10 pump	97
Dimensions	34		
Installation location	35	13 Technical data	98
Sound power levels	35	Technical data	99
		Energy efficiency label	102
6 Electrical connections	36	Energy efficiency specifications	
General information	36	of the package	102
Connections	37	Energy label	103
Additional connections	39	Electrical wiring diagrams	105
Settings	40		

1 Important information

SHK - Safety information

This manual contains installation and service procedures for implementation by specialists.

This appliance can be used by children aged 8 years and above and persons with reduced physical, sensory or mental capacity or lack of experience and knowledge, if they will be supervised or have received instruction concerning safe use of the appliance, and if they understand the danger involved in its use. Children must not play with the appliance. Cleaning and basic maintenance of the appliance must not be carried out by children unsupervised.

The rights to make structural changes are reserved.

©METROTHERM 2024

Symbols

 **CAUTION!**
This symbol indicates danger to the appliance or person.

 **TIP!**
This symbol indicates tips that will make it easier to operate the product.

 **NOTE!**
This symbol indicates important information to note while operating or maintaining the appliance.

Marking

SHK 20-200 is CE marked and has an IP21 protection rating.

The CE mark confirms that METROTHERM has ensured that the product conforms to all applicable regulations specified by the relevant EU directives. The CE mark is mandatory for most products sold in the EU, regardless of where they are made.

IP21 means that objects with a diameter greater than or equal to 12.5 mm cannot penetrate and cause damage and that the product is protected against vertically falling drops of water.

Serial number

The serial number is located at the bottom of the rating plate, on the top cover SHK 20-200 and consists of 14 digits.

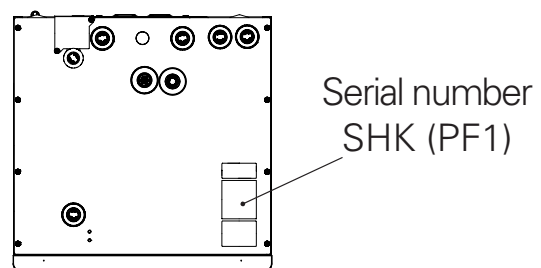

Waste disposal



Leave the disposal of the packaging to the installer who installed the product or to a special waste disposal facility.

Do not dispose of used products with normal household waste. It must be

transported to a special waste disposal facility or to a vendor who provides this type of service.

Improper disposal of the product by the user may result in administrative penalties in accordance with the applicable legislation.

Inspection of the installation

The climate system must be inspected before commissioning. The inspection must be carried out by a suitably qualified person. In addition, fill in the page for the installation data in the User Manual.

Checklist

	Description	Notes	Signature	Date
	Heating medium			
	Flushing the system			
	System vented			
	Expansion vessel			
	Particulate filter			
	Safety valve			
	Shut-off valves			
	Pressure in the climate system			
	Connected according to outline diagram			
	Leak test			
	Hot water			
	Shut-off valves			
	Mixing valve			
	Safety valve			
	Electric power supply			
	Connecting communication			
	Perimeter protection			
	Protection, indoor unit			
	Building protection			
	Outdoor temperature sensor			
	Room sensor			
	Current sensor			
	Safety circuit breaker			
	Residual-current device			
	Setting the thermostat to emergency mode			
	Checking the connections on the terminal block			
	Miscellaneous			
	Docked to			

METROAIR L - SAFETY INFORMATION

Electrical installation and wiring must be carried out in accordance with national provisions.

METROAIR L must be installed via an isolator switch. The cable area has to be dimensioned based on the fuse rating used. If the supply cable is damaged, only METROTHERM, its service representative or similar authorised person may replace it to prevent any danger and damage.

Fixed pipe connection

METROAIR L is intended for a fixed pipe connection to heating and/or the hot water system.

Handling

The heat pump contains A2L refrigerant. Special care should be exercised during handling, installation, service, cleaning and scrapping to prevent damage to the refrigerant system and thus reduce the risk of leakage.

! CAUTION!
Work on refrigerant systems must be carried out by personnel who have knowledge and experience of working with flammable refrigerants.

Environmental information

F-gas regulation (EU) no. 517/2014

This unit contains a fluorinated greenhouse gas that is covered by the Kyoto agreement.

The equipment contains R32, a fluorinated greenhouse gas with a GWP value (Global Warming Potential) of GWP 675. Do not release R32 into the atmosphere.

Safety precautions

! CAUTION!
Do not use agents to speed up the defrosting process or for cleaning, other than those recommended by the manufacturer.

The apparatus must be stored in a room with no continuous ignition sources (e.g. naked flame, an active gas installation or an active electric heater).

Must not be punctured or burned. Be aware that the refrigerant may be odourless.

General

Pipe installation should be kept to a minimum.

Mechanical connections of the cooling circuit made on site must be accessible during servicing.

The cooling circuit's pipes must be protected against physical damage.

Area checks

Before work is started on systems that contains combustible refrigerants, safety checks must be performed to ensure that the ignition risk is kept to a minimum.

Working method

The work must be carried out in a controlled way to minimise the risk of contact with combustible gas or liquid during the work.

General for the working range

All maintenance staff and those who work in close proximity to the product must be instructed which type of work is to be carried out. Avoid carrying out work in enclosed spaces. The area surrounding the worksite must be cordoned off. Ensure that the area is made safe by removing combustible material.

Check for the presence of refrigerant

Check whether there is refrigerant in the area using a suitable refrigerant detector prior to and during work, to notify the service technician whether there is a possible flammable atmosphere or not. Ensure that the refrigerant detector is suitable for combustible refrigerant, i.e. does not generate sparks or cause ignition in any other way.

Presence of fire extinguishers

If hot work is carried out on the heat pump, a powder or carbon dioxide fire extinguisher must be to hand.

Absence of ignition sources

Pipes connected to the unit must not contain potential sources of ignition.

Those who carry out work with refrigerant system connections, including exposing pipes that contain or have contained combustible refrigerant, may not use potential ignition sources in such a way that that can lead to risks of fire or explosions.

All potential ignition sources, including cigarette smoking, should be kept at a safe distance from the service work area where combustible refrigerant can leak out. Before carrying out work, the area surrounding the equipment must be checked to ensure that there are no ignition risks. „No smoking“ signs must be displayed.

Ventilated area

Ensure that the work is carried out outdoors or that the work area is ventilated before the system is opened and before any hot work is carried out. The area must be ventilated whilst the work is being carried out. There must be ventilation around any refrigerant that comes out, which should be routed outdoors.

Checking cooling equipment

If electrical components are replaced, the replacement parts must be fit for purpose and have the correct technical specifications. Always follow the manufacturer's guidelines regarding maintenance and servicing. Contact the manufacturer's technical department in the event of any doubts. The following checks must be carried out for installations that use combustible refrigerants.

- The actual filling quantity is appropriate for the magnitude of the space where the parts containing refrigerant are installed.
- Ventilation equipment and outlet

work correctly and without obstructions.

- If an indirect refrigerant circuit is used, check whether the secondary circuit contains refrigerant.
- All markings of equipment are visible and clear. Markings, signs and similar that are not clear must be replaced.
- Refrigerant pipes and components are positioned in such a way that it is not likely that they be subjected to substances that can corrode components containing refrigerant, if these components are not made of material that is resistant against corrosion, or not appropriately protected against such corrosion.

Checking electrical equipment

Repair and maintenance of electrical components must include initial safety checks and procedures for component inspection. In the event of a fault, which can cause a safety risk, do not supply any power to the circuit until the fault has been rectified. If the fault cannot be rectified immediately, and operation must continue, an adequate temporary solution must be implemented. This must be reported to the equipment owner, so that all parties have been informed.

The following checks must be carried out at the initial safety checks.

- That the capacitors are discharged. Discharging must be done safely, to prevent the risk of sparking.
- That no powered electrical components or live cables are exposed when filling or collecting refrigerant or when the system is flushed.
- That the system is continually earthed.

Repairing sealed components

When repairing sealed components, all electrical supply must be disconnected from the equipment that is being repaired before any sealed covers or similar are removed. If it is absolutely necessary to have an electricity supply to the equipment during the service, continuously activated leak tracing must be performed at the most critical points in order to warn of any dangerous situations.

Pay particular attention to the following so that the sheath is not changed in a way that affects the protection level when working with electrical components. This means damage to cables, unnecessary amounts of connections, terminals that do not follow the original specifications, damaged gaskets, incorrect grommets etc.

Ensure that the apparatus is secured properly.

Check that seals or sealing materials have not deteriorated to a degree that they can no longer prevent combustible gases from entering. Replacement parts must meet the manufacturer's specifications.



CAUTION!

- Use of silicone seals can hamper the efficiency of certain types of leaktracing equipment. Components with built in safety do not need to be isolated before starting work.

Wiring

Check that cabling will not be subject to wear, corrosion, excessive pressure, vibration, sharp edges or any other adverse environmental effects. The check shall also take into account the effects of aging or continual vibration from sources such as compressors or fans.

Leak testing

The following leak detection methods are deemed acceptable for systems containing flammable refrigerants.

Electronic leak tracers must be used to detect combustible refrigerant; but the leak tracer may not be sufficiently sensitive or may need to be recalibrated (the leak tracing

equipment must be calibrated in an area completely free from refrigerant). The leak tracer must not be a potential source of ignition and must be suitable for the relevant refrigerant. The leak tracing equipment must be set and calibrated for the relevant refrigerant, to ensure that the gas concentration is a maximum of 25% of the lowest combustible concentration (Lower Flammability Limit, LFL) of the relevant refrigerant.

Leak detection fluids are suitable for use with most refrigerants but the use of detergents containing chlorine shall be avoided as the chlorine may react with the refrigerant and corrode the copper pipework.

If a leak is suspected, all naked flames shall be removed/extinguished. If a leak that requires brazing is detected, all refrigerant must be removed from the system and stored in a separate container. Alternatively, the refrigerant can be stored separated from the brazing area in a part of the system at a safe distance from the leak, if this part of the system can be disconnected safely with shut-off valves. The system must be emptied in accordance with the section "Removal and draining".

Removal and draining

When a cooling circuit is opened for repairs – or for another reason – work must be carried out in a conventional manner. Due to the risk of fire it is important that best practice is applied. Follow the procedure below.

1. Remove the refrigerant
2. Open the circuit by cutting or brazing.

Collect the refrigerant in the intended cylinders.

Ensure that the vacuum pump's outlet is not near to any potential ignition sources and that there is satisfactory ventilation by the outlet.

Filling

In addition to the conventional filling procedures, the following actions must be taken.

- Ensure that different refrigerants are not mixed when filling equipment is used. Hoses and lines must be as short as possible to minimise the enclosed refrigerant volume.
- Containers must be stored in a suitable position in accordance with the instructions.
- Ensure that the cooling system is grounded before the system is filled with refrigerant.

- Mark the system once filling is complete (if not already marked). If the amount differs from the pre-installed amount, the marking must include the pre-installed amount, the added extra amount and the total amount.
 - Take extra care not to overfill the cooling system.
2. Isolate the system electrically.
 3. Before starting the procedure, ensure that:
 - necessary equipment for mechanical handling of the refrigerant container is available
 - all necessary personal safety equipment is available and used correctly
 - the collection process is continuously supervised by an authorised person
 - the collection equipment and containers meet appropriate standards.

Before refilling the system, pressure test it with oxygen-free nitrogen. Leak test the system after filling but before using the system. Perform an additional leak test before leaving the installation.

Decommissioning

Before the device is taken out of operation, the technician must without exception be very familiar with the equipment and all its component parts. Good practice prescribes that all refrigerant is collected safely. Before the collected refrigerant can be reused, oil and refrigerant samples must be taken, if analysis is required. There must be a power supply when this task is started.

1. Familiarise yourself with the equipment and its use.
4. Pump the refrigerant system to vacuum, if possible.
5. If it is not possible to pump to vacuum, manufacture a branch, so that the refrigerant can be retrieved from different parts of the system.
6. Check that the refrigerant container is on the scales before starting to collect.
7. Start the collection device and collect according to the manufacturer's instructions.
8. Do not overfill the containers (max. 80 % (volume) liquid content).
9. Do not exceed the containers' maximum permitted working pressure – not even temporarily.
10. When the containers have been filled correctly and the process is complete, close all shut-off valves in the equipment and remove and containers and equipment from the installation immediately.

11. The collected refrigerant must not be filled in any other system before being cleaned and checked.

Marking

The equipment must be marked stating that it has been taken out of operation and drained of refrigerant. The marking must be dated and signed. Check that the equipment is marked indicating that it contains combustible refrigerant.

Collection

Best practice prescribes that all refrigerant is collected safely when the refrigerant is drained from a system, either for servicing or for decommissioning.

The refrigerant must only be collected in suitable refrigerant containers. Ensure that the required number of containers, which can hold the entire volume of the system, are available. All containers that are to be used must be intended for the collection of the refrigerant and marked for this refrigerant (specifically designed for the collection of refrigerant). The containers have to be equipped with correctly functioning pressure relief valves and shut-off valves. Empty collection containers must be drained and, if possible, chilled before collection.

The collection equipment must

function correctly and instructions for the equipment must be to hand. The equipment must be suitable for the collection of combustible refrigerant.

Fully functioning and calibrated scales must also be to hand.

Hoses must be in good condition and be equipped with leak-proof quick couplings. Before using the collecting machine, check that it is working correctly and has been properly maintained. Associated electrical components must be sealed, to prevent ignition if any refrigerant should leak out. Contact the manufacturer if you are in any doubt.

Return the collected refrigerant to the refrigerant supplier in the correct collection container and with the relevant Waste Transfer Note. Do not mix refrigerants in collection devices or containers.

If compressors/compressor oil are/is to be removed ensure that the affected device is drained to an acceptable level to ensure that no combustible refrigerant remains in the lubricant. Compressors must be drained before being returned to the supplier. Only electrical heating of the compressor housing may be used to quicken draining. Drain oil from the system in a safe manner.

Miscellaneous

Maximum amount of refrigerant:
See Technical Specifications in the
Installer Manual.

- Everyone who works with or opens a refrigerant circuit must have a current, valid certificate from an accredited industry issuing body, which states that, according to the industry's recognised assessment standard, they have the authority to safely handle refrigerants.
- Servicing must only be performed according to the equipment manufacturer's recommendations.

Maintenance and repairs that require the assistance of another trained person must be carried out under the supervision of person with the authority to handle combustible refrigerants.

Maintenance and repair that requires the skill of another person must be carried out under the supervision of someone with the above expertise.

2 Delivery and handling

Available models

- SHK 20-200 units include the following separate models:
- SHK 20-200/6 – unit dedicated for use with L6.1 Split, enamelled tank equipped with a titanium anode.
 - SHK 20-200/12 – unit dedicated for use with L10.1 Split, enamelled tank equipped with a titanium anode.

Compatibility

The SHK 20-200 unit can be used with Split type outdoor units. The compatible METROTHERM SPLIT heat pumps are:

Indoor unit	Compatibility
SHK 20-200/6	L6.1
SHK 20-200/12	L10.1

More information on METROTHERM SPLIT heat pumps available at www.metrotherm.dk and in dedicated installation and user manuals. See section „Accessories” for the list of accessories to be used with SHK 20-200.

Transport

The SHK 20-200 indoor unit should be transported and stored vertically. Storage location must be dry. SHK 20-200 can be transported into the building vertically or carefully placed on the rear wall with the display facing up.

Assembly

REQUIREMENTS FOR INSTALLATION SPACE „(R32)”

For systems with a total refrigerant amount less than 1.84 kg R32, there is no space requirement.

SHK 20-200/6 +METROAIR L6.1 Split

SHK 20-200/6 with the L6.1 unit is filled with 1.3 kg of refrigerant from the factory and therefore has no specific requirements regarding installation space. If the pipe length exceeds 15 m (max. 30 m), refrigerant must be charged at 0.02 kg/m (max. 0.3 kg). The total refrigerant amount is always below the limit value of 1.84 kg.

SHK 20-200/12 + METROAIR L10.1 Split

SHK 20-200/12 with the L10.1 unit is filled with 1.84 kg of refrigerant from the factory. When the pipe length is longer than 15 m, the refrigerant must be filled to max. 0.02 kg/m. Because the total refrigerant amount then exceeds 1.84 kg, the accessory AGS 10 (automatic gas separator) must be installed and consideration must be given to the size of the indoor unit's installation space with regard to the total amount of refrigerant. A total refrigerant amount exceeding 2.54 kg R32 is not permitted in the system. See table „Minimum floor area SHK 20-200/12 + L10.1”.

Pipe-length (m)	Fill amount (kg)	m _c (kg) ¹	Minimum floor area (A _{min} h _{inst}) (m ²)	
			H ² =1,0 m	H=1,8 m
≤15	0,00	1,84	No requirements for installation	
16	0,02	1,86	8,10	4,50
17	0,04	1,88	8,19	4,55
18	0,06	1,90	8,28	4,60
19	0,08	1,92	8,37	4,65
20	0,1	1,94	8,45	4,70
21	0,12	1,96	8,54	4,74
22	0,14	1,98	8,63	4,79
23	0,16	2,00	8,71	4,84
24	0,18	2,02	8,80	4,89
25	0,2	2,04	8,89	4,94
26	0,22	2,06	8,98	4,99
27	0,24	2,08	9,06	5,04
28	0,26	2,10	9,15	5,08
29	0,28	2,12	9,24	5,13
30	0,3	2,14	9,32	5,18
31	0,32	2,16	9,41	5,23
32	0,34	2,18	9,50	5,28
33	0,36	2,20	9,59	5,33
34	0,38	2,22	9,67	5,37
35	0,4	2,24	9,76	5,42
36	0,42	2,26	9,85	5,47
37	0,44	2,28	9,93	5,52
38	0,46	2,30	10,02	5,57
39	0,48	2,32	10,11	5,62
40	0,5	2,34	10,20	5,66

¹ - Total refrigerant amount

² - H = installation height to bottom edge of AGS 10 and ventilation holes SHK 20-200.



NOTE!

When installing AGS 10 below 1.0 m, the minimum floor area should be calculated based on the EN 378-1 standard.

- SHK 20-200 must be set on a solid waterproof base that would keep the weight of the indoor unit. The regulated legs of the heat pump allow for levelling and stable setting of the device.

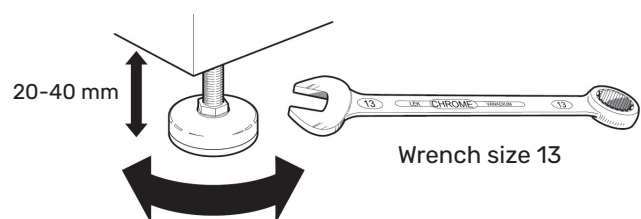

- Since SHK 20-200 has condensation water drainage, the set-up location of the indoor unit should be equipped with a floor drain leading to the sewage system.

Installation location

Leave a free space of 800 mm in front of the indoor unit. There must be a minimum free space of 70 mm behind the indoor unit, however the recommended distance is 150 mm. All servicing of SHK 20-200 can be carried out from the front.

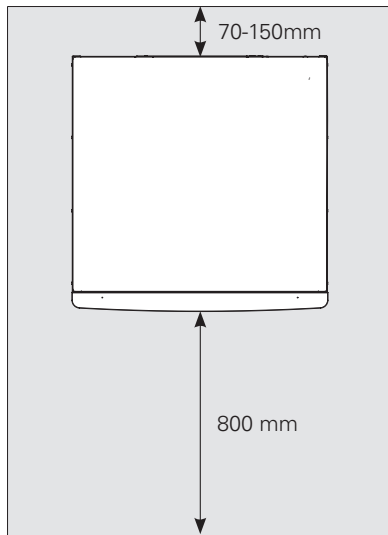

CAUTION!

If connecting an additional heat source, leave sufficient space behind the appliance for problem-free completion of the connections and future maintenance.

Supplied components

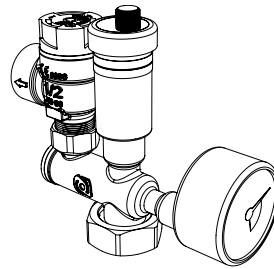

Safety group with safety valve (3 bar), pressure gauge and automatic air vent (1 pc.)

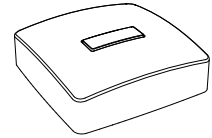

Outdoor temperature sensor (1 pc.)
Connection - see subsection „Additional connections“.

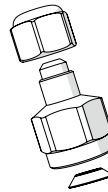

Reduction 3/8" na 1/4"
(1 pc.)
(SHK 20-200/12)

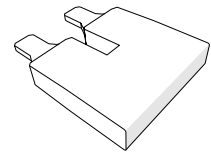

230V connection jumper (1 pc.)

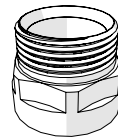

Connector 1"
(1 pc.)



Installation and user manual
(1 pc.)

Removing the cover

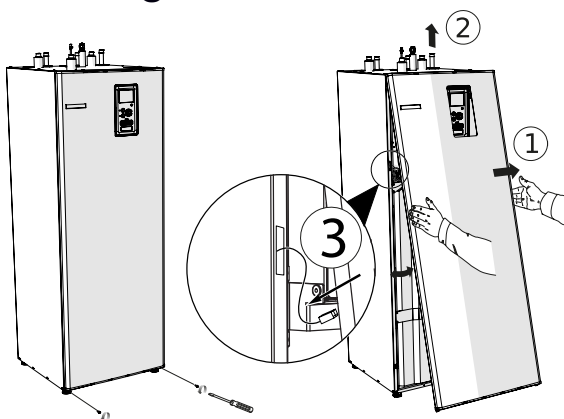

1. Remove screws at the bottom edge of the front cover.
2. Open the cover at the lower edge, taking care to not damage the connecting cables, and then remove the front cover by lifting it up.
3. Disconnect the cable connecting the front cover to the unit.



CAUTION!

The rated opening pressure of the safety valve is 3 bar.

3 Design of the indoor unit

SHK 20-200

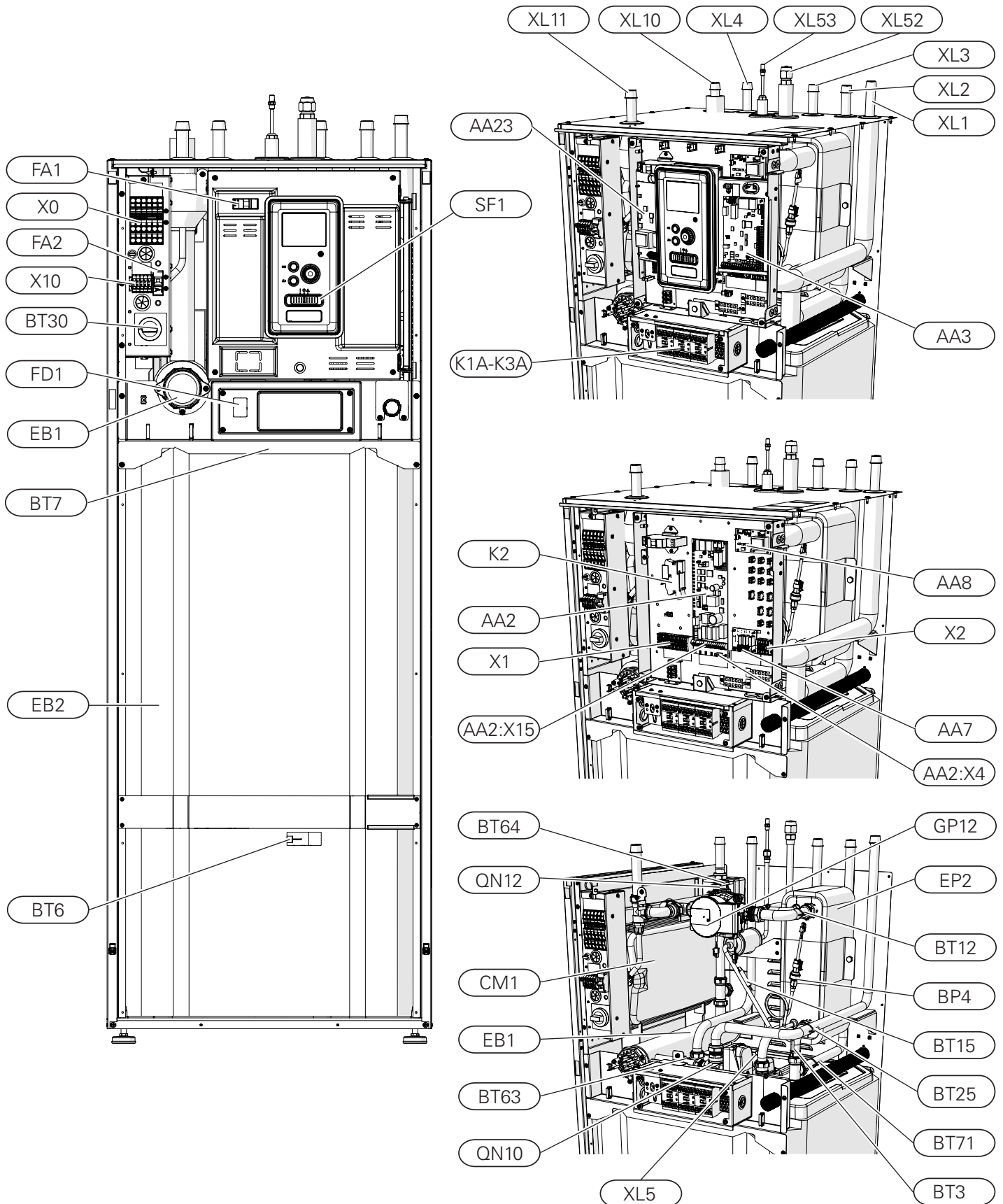

LEGEND

Pipe connections

XL1	Connection, heating medium, supply
XL2	Connection, heating medium, return
XL3	Connection, cold water
XL4	Connection, hot water
XL5	Connection, hot water circulation
XL10	Connection, cooling
XL11	Connection, safety group
XL52	Connection, gas cooling medium
XL53	Connection, liquid cooling medium

HVAC elements

CM1	Expansion vessel, closed
QN10	Reversing valve, hot water/climate system
QN12	Isolation valve, cooling/heating
GP12	Circulation pump
EP2	Heat exchanger

Sensors

BP4	Pressure sensor, high pressure
BT3	Temp. sensor, heating medium return
BT6	Temp. sensor, hot water charging
BT7	Temp. sensor, hot water heater top
BT12	Temp. sensor, condenser out
BT15	Pressure sensor, high pressure
BT25	Temp. sensor, heating medium supply
BT63	Temp. sensor, supply heating medium behind immersion heater
BT64	Temp. sensor, cooling operation system supply
BT71	Temp. sensor, heating medium return

Electrical components

X0	Power terminal - 230V~ / 400V~
X1	Control panel terminal block
X2	Control panel terminal block
X10	Outdoor unit connection terminal - 230 V~
AA2:X4	Terminal block - low voltage
AA2:X15	Terminal block - low voltage
K1A-K3A	Contactors for electric additional heat
K2	Alarm relay
BT30	Standby mode thermostat
AA2	Main board
AA3	Input board
AA23	Communication board
AA7	Extension card
AA8	Titanium anode board
FD1	Thermal circuit breaker
FA1	Miniature circuit breaker (protecting the control system of indoor unit)
FA2	Miniature circuit breaker (protecting the outdoor unit)
EB1	Electric additional heat

Miscellaneous

SF1	Controller switch
EB2	Hot water tank

4 Pipe connections

General information

Pipe installation must be carried out in accordance with the current standards and directives.

The pipe dimensions should not be less than the recommended pipe diameter according to the table below. However, in order to achieve the recommended flow, each installation must be dimensioned individually.

Minimum system flow

The installation must be dimensioned at least to the extent required to manage the minimum defrosting flow at 100% circulation pump operation, see table.

Air/water heat pump	Minimum flow during defrosting (100% pump capacity [l/s])	Minimum recommended pipe dimension (DN)	Minimum recommended pipe dimension (mm)
SHK 20-200/6 + L6.1	0,19	20	22
SHK 20-200/12 + L10.1			

CAUTION!
An incorrectly dimensioned climate system can result in damage to the appliance and lead to malfunctions.

The system can be used with a low- and medium-temperature climate system. The recommended temperature of the heating medium at the dimensioned outdoor temperature DOT must not exceed 55°C on the supply and 45°C on the return circulation from the climate system. SHK 20-200 can reach up to 70°C when using the electric additional heat or another peak heat source.

An overflow pipe must be routed from the safety valve to a suitable drain. The entire length of the overflow pipe must be inclined towards the floor drain to prevent water pockets and must also be frost-proof. In order to reach maximum system efficiency, we recommend installing SHK 20-200 as close as possible to the outdoor heat pump.

The SHK 20-200 unit is not equipped with a shut-off valve for the climate system. In order to facilitate future servicing, the shut-off valves should be installed on the outside of the indoor unit.

The SHK 20-200 unit can be docked to the central heating, cooling operation and hot water systems. It is absolutely necessary to install the safety assembly on connection XL11.

CAUTION!
Ensure that incoming heating medium is without pollution. Detailed information can be found in Section 7 „Heating water parameters“.

CAUTION!
In the installation before the SHK 20-200, a particulate filter should be used, dedicated for heating installations. The filter will protect the unit against pollution.

CAUTION!
All high points in the climate system must be equipped with air vents.

CAUTION!
The pipelines need to be flushed out before the indoor unit is connected so that any debris cannot damage component parts.

CAUTION!
Until the system's heating/cooling circuit has been filled with heating medium, the switch (SF1) in the controller must not be set to "I" or „Δ“. If you do not comply with the above instructions, many components of the SHK 20-200 unit may be damaged.

Expansion vessel

The expansion vessel's volume must be at least 5% of the system's total volume. SHK 20-200 appliances have been equipped with an expansion vessel with a 10 l volume. If the capacity of the built-in expansion vessel is insufficient, an additional expansion vessel meeting the above requirements should be added to the installation.

The expansion vessel should be selected in accordance with current standards.

Table with examples:

Total volume [l] (indoor unit and climate system)	Volume [l], expansion vessel
500	10+15
750	10+25
1000	10+40

The pressure setting in the level vessel should be set according to the maximum height (H) between the vessel and the highest-positioned radiator, see drawing. An initial pressure of 0.5 bar (5 mvp) means a maximum permissible height difference of 5 m.

The maximum volume of the system without a boiler is 220 l at the above initial pressure.

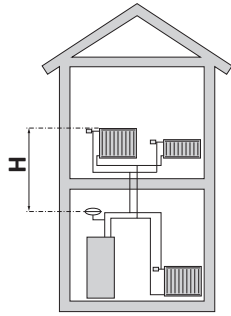

If the standard initial pressure in the expansion vessel is too low, this can be increased by filling it via the installed valve. The expansion vessel's standard initial pressure must be entered in the checklist on page 5.

Any change in the initial pressure affects the ability of the expansion vessel to handle the expansion of the heating medium.

Buffer vessel

The heat pump installation requires an appropriate volume of heating medium (approx. 10l/kW heat pump power) and a minimum, undisturbed flow.

In case of an insufficient amount of heating medium in the installation, an additional buffer vessel must be used, which will ensure adequate system volume, see subsection "Minimum climate system volumes".

An insufficient flow in the central heating system will cause malfunction of the heat pump installation and could lead to serious damage of the product.



CAUTION!

In order to obtain the minimum undisturbed flow in the climate system, use the appropriate hydraulic solutions (e.g. relief valve, low loss header, parallel buffer and/or open heating loops). Remember to always maintain the minimum required flow in the system - see the subsection "Minimum system flow".



NOTE!

It is recommended to equip the hot water system with into an expansion vessel. It is also necessary to install a safety valve with the required opening pressure.

Minimum climate system volumes

METROAIR L	L6.1	L10.1
Minimum climate system volume during heating/cooling	50 l	80 l

System diagram

The SHK 20-200 indoor unit is equipped with a storage tank with a hot water coil, expansion vessel, safety group, electric additional heat, reversing valves, plate heat exchanger, energy meter, electronic circulation pump and controller. Combined together with the METROTHERM SPLIT (METROAIR L) outdoor air heat pump unit, it forms a complete climate system.

The METROAIR L outdoor unit supplies thermal energy for heating domestic water, powering the climate system, heating swimming pools and cooling operation, using free energy contained in the air outside, working efficiently in the low temperature range, as low as -20°C.

The connection of the outdoor unit and the indoor unit SHK 20-200, with a system of pipes filled with refrigerant, protects the connection against freezing in the event of interruptions in the electric power supply to appliances. The system's operations are controlled using an advanced controller.

The control mechanism of SHK 20-200 allows for two cooling operation systems to be used:

- 2-pipe cooling system,
- 4-pipe cooling system.



NOTE!

SHK 20-200 is equipped with all temperature sensors as standard. In some system layouts, the sensors must be transferred to other parts of the system. For location of the sensors, see the relevant point on docking the system.









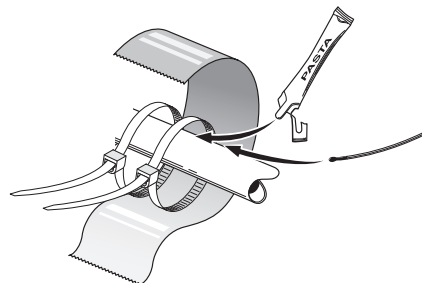

















NOTE!

In the event that the water volume of the central heating system is increased using a buffer vessel, you will need to check the system volume and possibly increase the volume of the existing expansion vessel.

Temperature sensor installation on pipe



The temperature sensors are fitted using heat conducting paste, cable ties (the first cable tie is secured to the pipe in the middle of the sensor and the other cable tie is mounted approx. 5 cm after the sensor) and aluminium tape. After putting on the ties and the aluminum tape, the sensor should be carefully insulated with aluminium tape.

	Shut-off valve		Electric additional heat		Domestic hot water
	Non-return valve		Cooling system filter		Overflow valve
	Shunt valve		Compressor		Additional heat source
	Safety valve		Plate heat exchanger		Buffer vessel
	Temperature sensor		SHK		Fan coil
	Expansion vessel		Cooling operation		Optional components
	Manometer		Central heating system (radiator)		
	Filterball		Central heating system (under floor heating systems)		
	Automatic air vent				
	Circulation pump				

NOTE!

The installation diagrams presented in the manual are examples and do not include all system components. They do not replace the design of the building's central heating system.

Basic diagram with series-parallel connection of a buffer tank

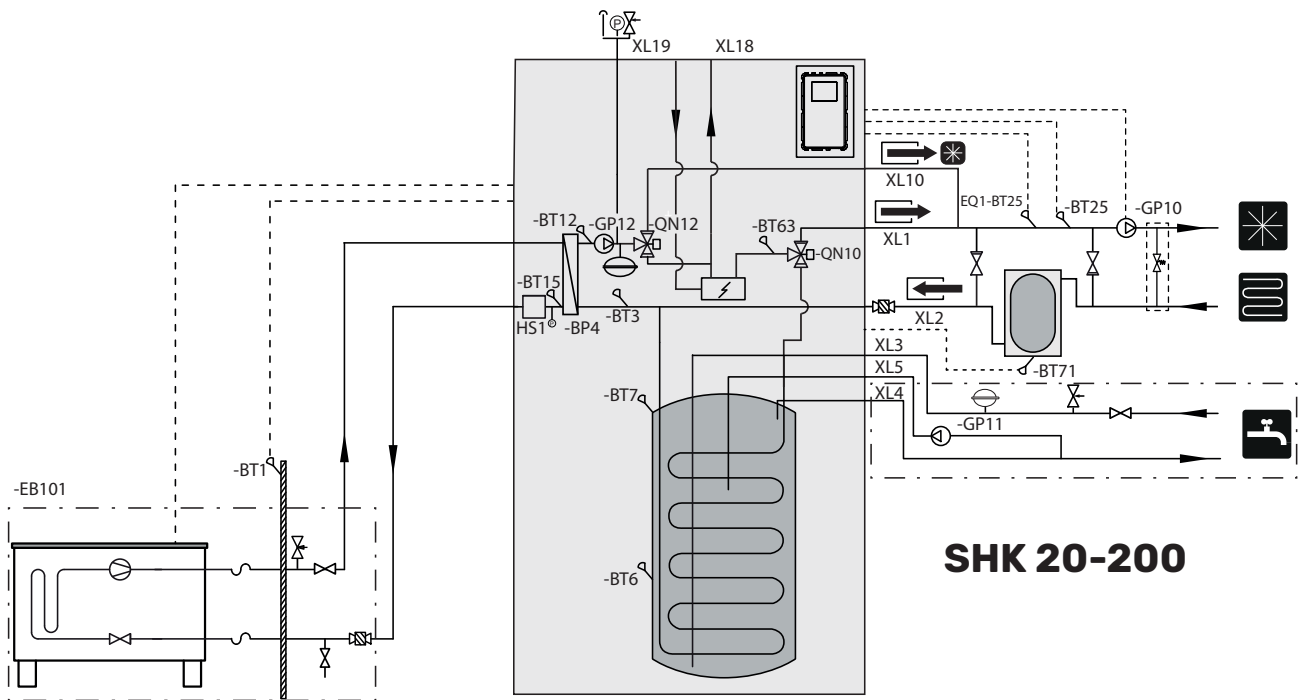

The diagram above is a basic 2-pipe diagram with a buffer. If a buffer is used in the installation, remember to transfer the BT25 sensor to the installation in accordance with the diagram. In a 2-pipe system, the controller supports all sys-

tem components, i.e. GP12, extension modules (additional heating/cooling circuits), etc. The 2-pipe system can be selected in the SERVICE section, menu 5.2.4. Cooling must be activated in menu 5.11.1.1.

Diagram of heating and 2-pipe cooling with series-parallel connection of a buffer tank

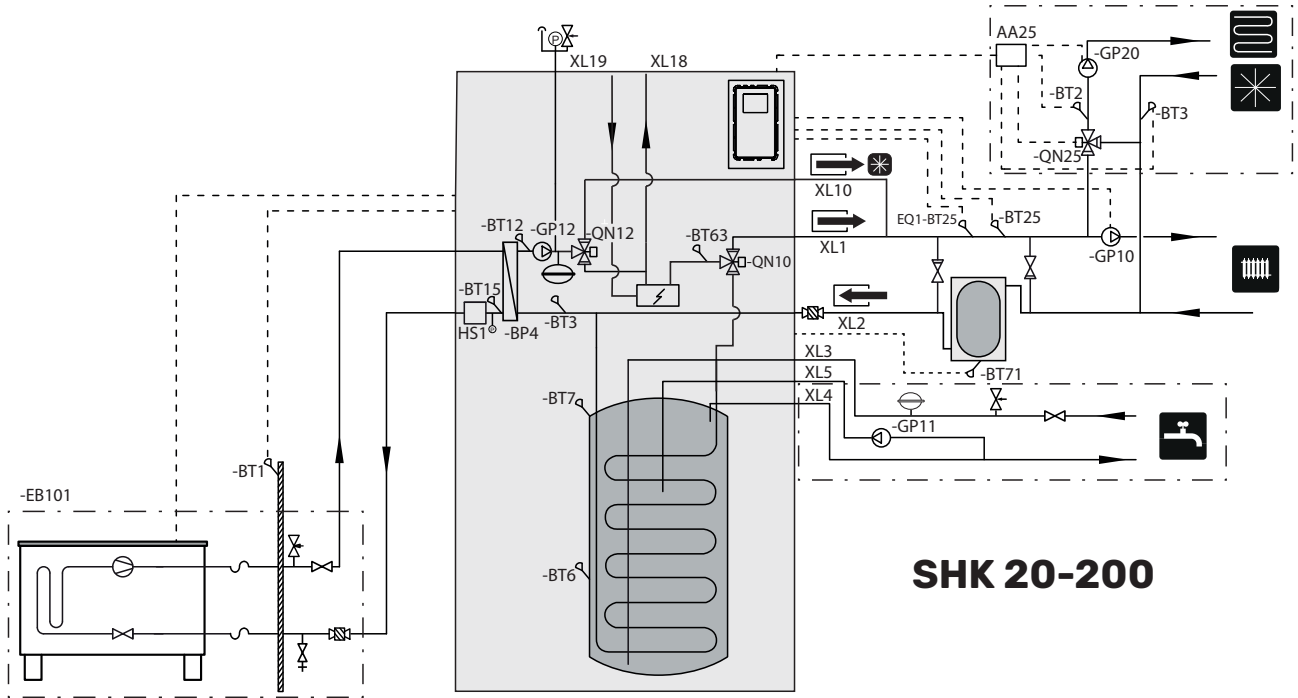

If a buffer is used in the installation, remember to transfer the BT25 sensor to the installation in accordance with the diagram. The principle of operation of the 2-pipe system is to use the same installation for cooling as for heating (diagram of a 2-pipe cooling operation). In a 2-pipe system, the

controller supports all system components, i.e. GP12, extension modules (additional heating/cooling circuits), etc. The 2-pipe system can be selected in the SERVICE section, menu 5.2.4. Cooling must be activated in menu 5.11.1.1.

Diagram of 4-pipe cooling operation

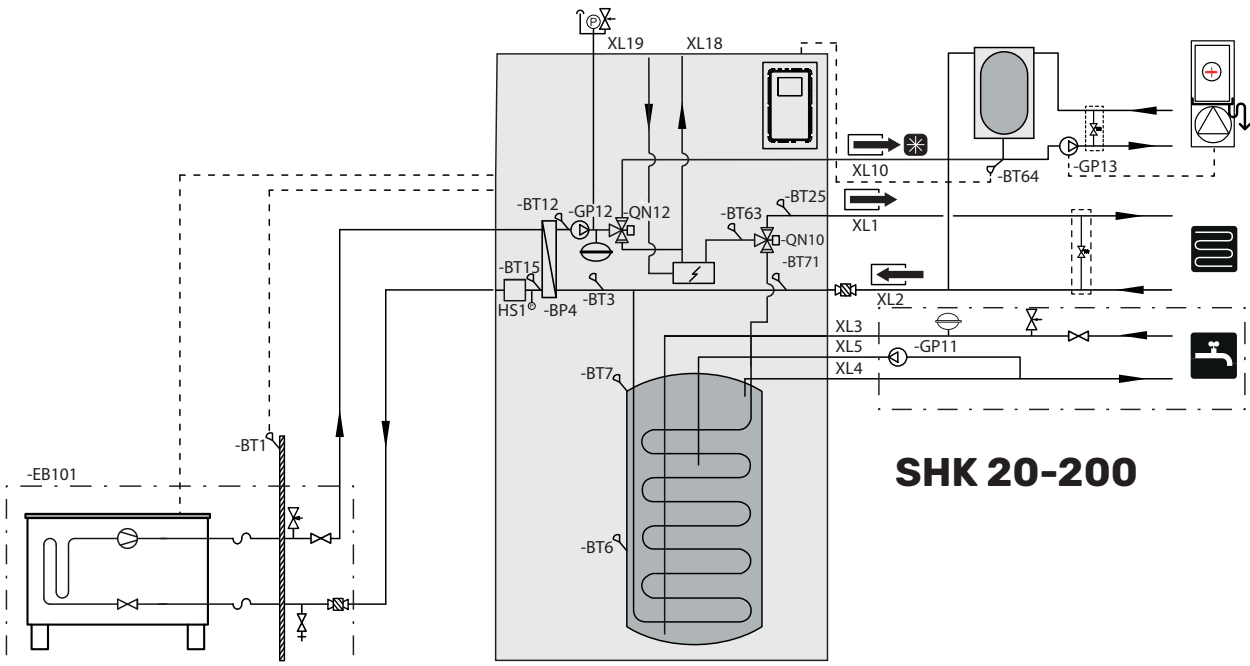

The operating principle of the 4-pipe system is to use separate heating and cooling circuits. In the 4-pipe system, a cooling tank is required. The BT64 sensor should be placed in the buffer vessel or on the cooling flow pipeline.

BT64 is connected at the AUX inputs. Selection of the 4-pipe system can be found in the SERVICE section, menu 5.2.4. Cooling must be activated in menu 5.11.1.1.

Scheme with the connection of an additional heat source

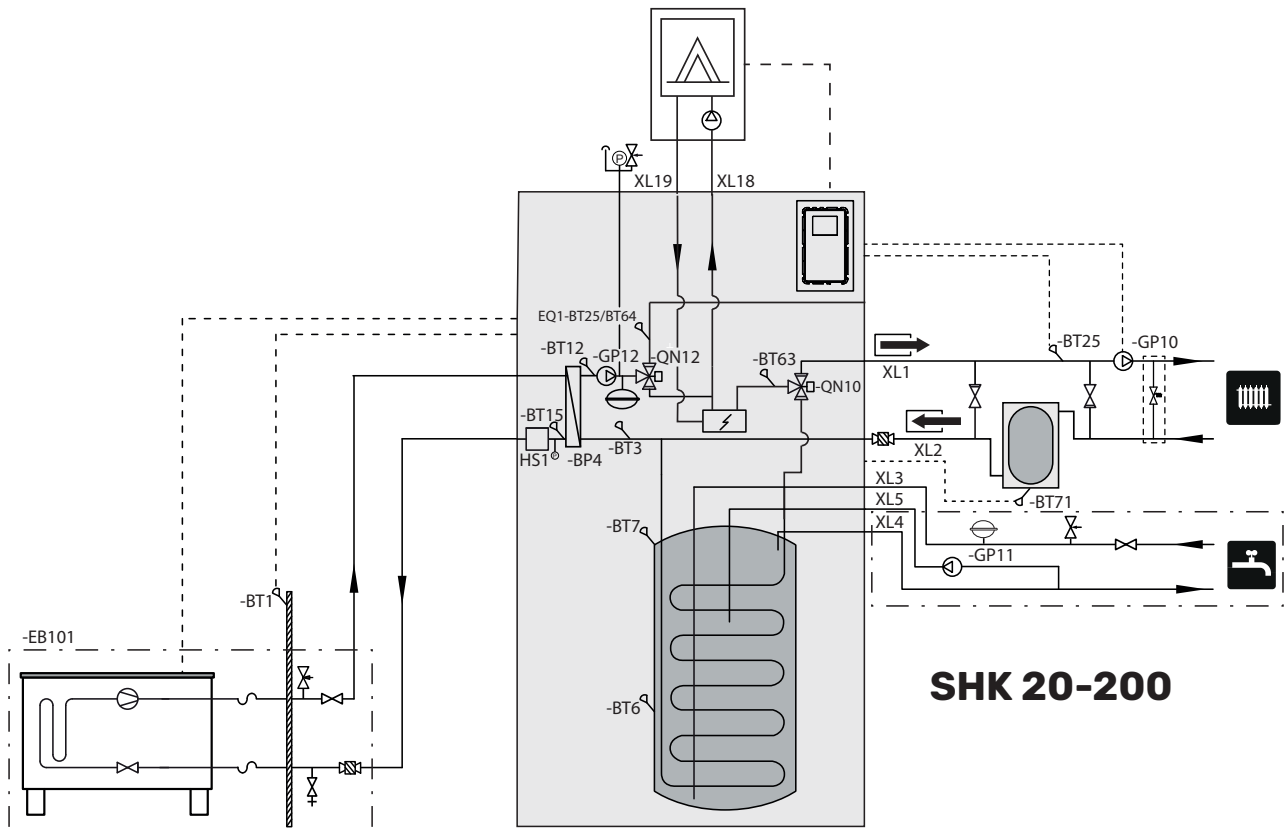

NOTE!

The maximum recommended power of the additional heat source cannot exceed 15kW.

- It is recommended that you install the SHK 20-200 unit in a room which is equipped with a floor drain and protected against freezing.
- The ground should be of a sufficient load capacity, preferably concrete.
- The SHK 20-200 unit must be positioned with its back against a building wall. The device should not be placed against the walls of rooms in use where noise could be a problem.
- The appliance can be levelled using the adjustable feet.
- Route pipes so they are not adjacent to the wall of a bedroom or living room where noise could be a problem.
- Ensure that there is approx. 800 mm free space in front of and 500 mm above the appliance to facilitate any future servicing.

Recommended order of assembly

1. Dock the SHK 20-200 unit to the central heating system as well as the cold and hot water pipelines.
2. Install refrigerant pipes.
3. Connect the current sensors, outdoor temperature sensor, the lines between SHK 20-200 and METROAIR L, as well as the communication and power supply.
4. Connect the electric power supply (230V or 400V) to the SHK 20-200 unit.
5. Proceed according to the commissioning instructions in the section Commissioning and adjusting.

Pipe connections

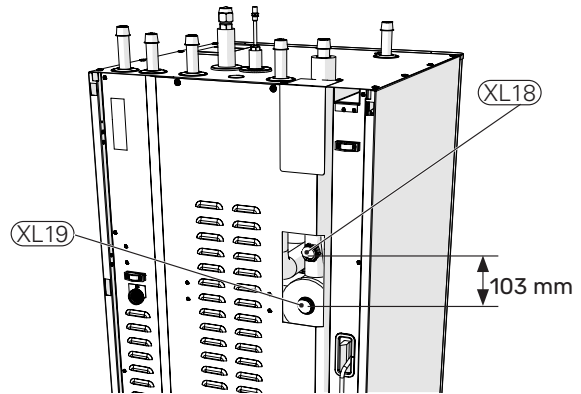
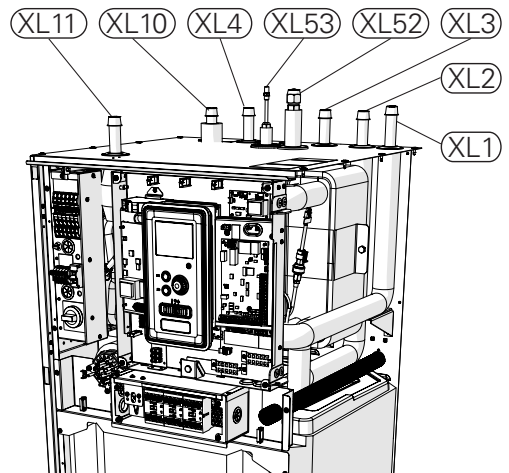
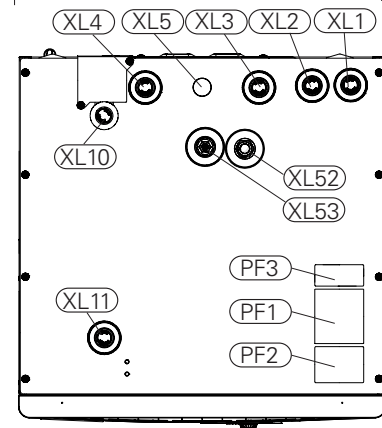
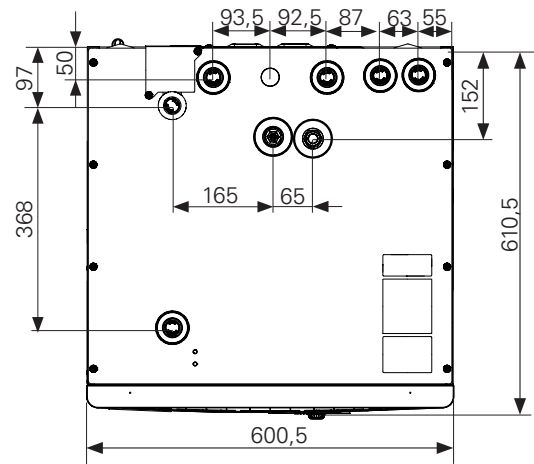
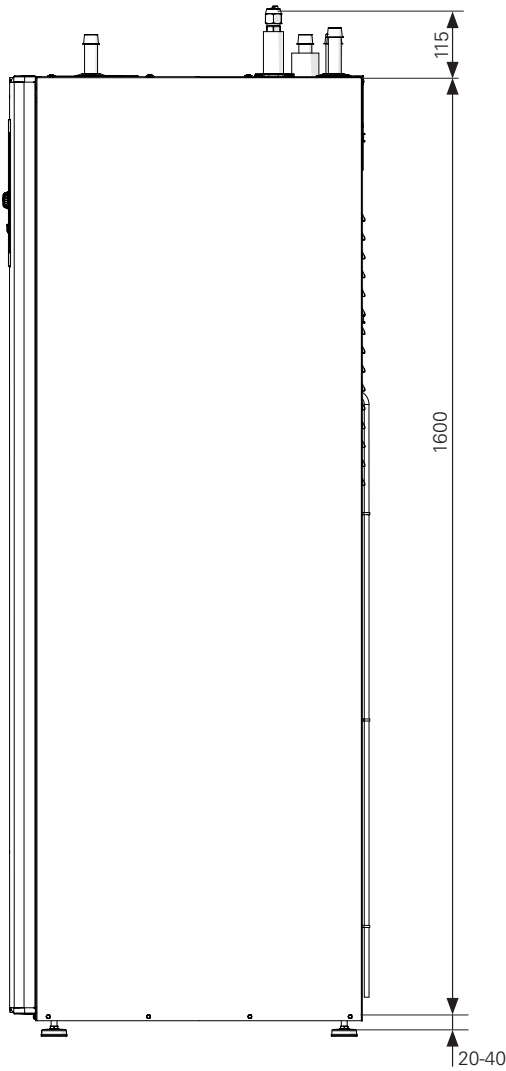

Pipe connections

- XL1 Connection, Heating medium supply $\varnothing 22$ mm
- XL2 Connection, Heating medium return $\varnothing 22$ mm
- XL3 Connection, cold water $\varnothing 22$ mm
- XL4 Connection, hot water $\varnothing 22$ mm
- XL5 Connection, circulation $\varnothing 15$ mm
- XL10 Connection, cooling $\varnothing 22$ mm
- XL11 Connection, safety group $\varnothing 22$ mm, manometer
- XL52 Gas cooling medium
Connection 1/2" (SHK 20-200/6)
Connection 5/8" (SHK 20-200/12)
- XL53 Liquid cooling medium
Connection 1/4" (SHK 20-200/6)
Connection 3/8" (SHK 20-200/12) - 1/4" adapter for L10.1 units included.
- XL18 Connection, return to an additional heat source $\varnothing 22$ mm
- XL19 Connection, supply from additional heat source $\varnothing 22$ mm

Other information

- PF1 Serial number
- PF2 Plate with the designation of the hydraulic connections
- PF3 Warning plate

Docking the indoor unit

Docking the climate system

The pipe connections of the climate system are made from the top of the appliance.

- All required safety devices and shut-off valves must be fitted as close to the SHK 20-200 unit as possible.
- Vent valves must be installed when necessary.
- The safety group with the pressure gauge and air vent on the central heating circuit, as well as the safety valve on the hot water system must be fitted to the appropriate connections XL 11 and XL 3. To prevent air pockets from forming, the overflow pipe must be inclined in its entire length from the safety valve and must also be frost proof.
- When connecting to the installation (where all radiators / underfloor heating circuits are equipped with thermostatic valves or solenoid valves), appropriate hydraulic solutions should be used to obtain a minimum undisturbed flow in the heating system (e.g. excess-relief valve, low loss header, buffer in parallel or open heating loops). Remember to always keep the minimum required flow and volume of the system - see the sections "Minimum system flow" and "Buffer vessel".

CAUTION!
The term "heating system", as used in this installation and operation manual, shall mean the heating or cooling system supplied with a hot or cold medium from the SHK 20-200 module for heating or cooling purposes.

NOTE!
Suitable safety valve must be installed directly on the cold water supply line to the hot water tank. Safety valve will protect against excessive increase of pressure. The drain from the safety valve should be discharged into the sewage system or drain.

Connection of the external heat source

An external heat source with a maximum power of 15 kW, e.g. a gas or solid fuel boiler, can be connected to the back of the SHK 20-200 unit after removing the plate blocking access to the connection sockets (picture below). See subsection System diagram.

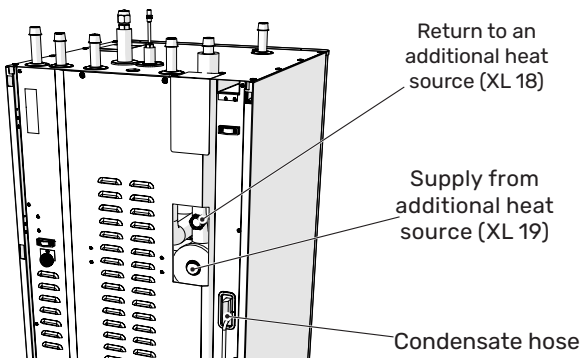

Condensate elimination

The SHK 20-200 unit has a condensate hose to drain the condensation water from the drip tray located under the hot water tank. The pipe drains all of the condensation water away from the appliance, minimizing the risk of damage. This pipe can be extended or replaced if needed.

Connecting refrigerant pipes (not supplied)

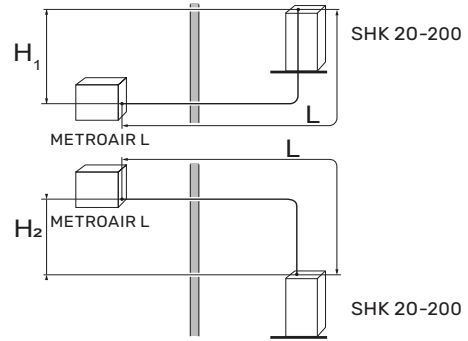

NOTE!
The outdoor unit, filled with refrigerant at the factory, allows for the use of refrigerant pipes (size L) between the outdoor unit and the indoor unit measured with a pipe length of $L = 15\text{m}$. For maximum allowable refrigerant piping lengths, see the table below.

To properly top up the refrigerant, see the section "Filling the system with refrigerant".

METROAIR L

Refrigerant pipes must be installed between the external module METROAIR L and SHK 20-200.

The installation must be executed according to the applicable standards and directives.

PARAMETERS

	unit	SHK 20-200	
		-6	-12
Max. length, refrigerant pipe, one way (L)	m	30	40
Max height difference, when SHK 20-200 is placed higher than METROAIR L (H_1)	m	20	15
Max height difference, when SHK 20-200 is placed lower than METROAIR L (H_2)	m	20	30

- The connection between the outdoor unit and the indoor unit must ensure free flow of the refrigerant.

Refrigerant connection pipeline specification

L6.1

	Gas pipe (∅ ext.)	Liquid line (∅ ext.)
Pipe dimensions	∅12,7 mm (1/2")	∅6,35 mm (1/4")
Connection	Connection - (1/2")	Connection - (1/4")
Material	Copper quality SS-EN 12735-1 or C1220T, JIS H3300	
Minimum wall thickness	1,0 mm	0,8 mm

L10.1

	Gas pipe (∅ ext.)	Liquid line (∅ ext.)
Pipe dimensions	∅15,88 mm (5/8")	∅6,35 mm (1/4")
Connection	Connection - (5/8")	Connection - (1/4")
Material	Copper quality SS-EN 12735-1 or C1220T, JIS H3300	
Minimum wall thickness	1,0 mm	0,8 mm

- Carry out the pipe installation when the service valves (QM35, QM36) are closed.
- Remove the side panel from METROAIR L during installation to facilitate access.

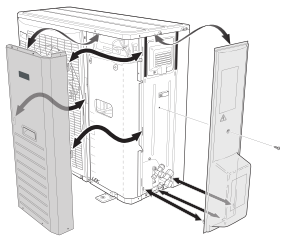

- Take care to ensure no water or pollutants enter the refrigerant connection pipe. Pollutants in the pipes risks damage to the heat pump.
- Bend the pipes with the maximum bending radius (at least R100-R150). Do not bend the pipes repeatedly. Use a bending machine.
- The connection of refrigerant pipes to the outdoor unit and the indoor unit should be made with flared connections after removing the production ends.
- L10.1: Use the 3/8" to 1/4" adapter included with SHK 20-200/12. Not forgetting to put the gasket on. The drawing below shows how to install the adapter.

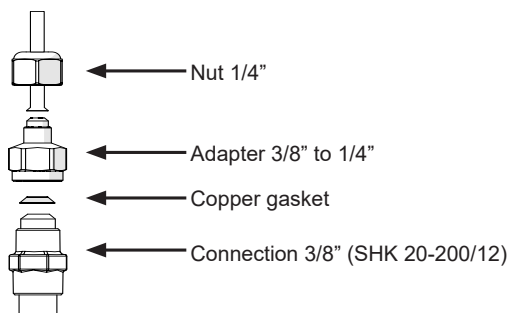

NOTE

The SHK 20-200/12 unit is equipped with a 3/8" to 1/4" liquid connection adapter (XL53). The adapter should be used when the control panel is connected to the L10.1 Split outdoor unit.

- Make and connect the flare-connection and tighten with the appropriate torque using a torque wrench. Use the appropriate tightening angle, if a torque wrench is not available.

External diameter, copper pipe (mm)	Tightening torque (Nm)	Tightening angle (°)	Recommended tool length (mm)
∅6,35	14-18	45-60	100
∅9,52	34-42	30-45	200
∅12,7	49-61	30-45	250
∅15,88	68-82	15-20	300

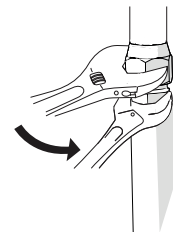

CAUTION!

Gas shielding must be used when soldering.

Flare connections

Expansion:

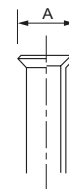

External diameter, copper pipe	A (mm)
∅ 6,35 (1/4")	9,1
∅ 9,52 (3/8")	13,2
∅ 12,7 (1/2")	16,6
∅ 15,88 (5/8")	19,7

Ejection:

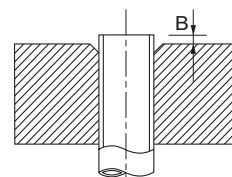

External diameter, copper pipe (mm)	B, using the tool R32 (mm)	B, using the conventional tool (mm)
∅ 9,52 (3/8")	0,0-0,5	0,7-1,3
∅ 15,88 (5/8")		
∅ 6,35 (1/4")		1,0-1,5
∅ 12,7 (1/2")		

Pressure test and leak test

Both SHK 20-200 and METROAIR L are factory tested for pressure and leakage, but the refrigeration pipe connections between appliances should be checked for leakage after installation.

When connecting the pipes, carrying out pressure tests and leak tests, and creating the vacuum, remember to keep the service valves (QM35, QM36) closed. In order to fill the pipes of SHK 20-200 with refrigerant, they must be reopened.

CAUTION!

The pipe connection between the indoor unit and the outdoor unit must be leak tested. Then create a vacuum for the completed pipeline after finishing installation, in accordance with the applicable regulations. Only nitrogen should be used for pressure testing of the completed pipeline.

Vacuum pump

Use a vacuum pump to remove all air. Apply suction for at least one hour and end pressure after evacuation must be 1mbar (100 Pa, 0.75 Torr or 750 micron) absolute pressure. If the system is still damp or leaking, the vacuum will decrease after the draining has finished.

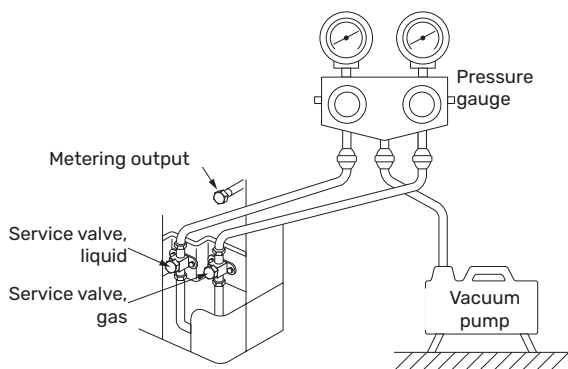

TIP!

To achieve a better end result and speed up creation of the vacuum, please follow the below points:

- The pipelines must have the correct diameter and length.
- Drain the system to 4 mbar and fill it with dry nitrogen to atmospheric pressure.

Filling the system with refrigerant

METROAIR L is delivered complete with the refrigerant required for the installation of refrigerant pipes with lengths of up to 15 m on either side. If the length of the refrigerant pipes exceeds 15 m, extra refrigerant must be added in the amount of 0.02kg/m (applies to SHK 20-200/6 and SHK 20-100/12) (see the subsection „Assembly” and „Connecting the refrigerant pipe”).

NOTE!

For installations with refrigerant pipes up to 15 m in length, no extra refrigerant in addition to the provided amount needs to be added.

Insulating refrigerant pipes

- Refrigerant pipes (both liquid and gas) must be insulated for the purpose of thermal insulation and in order to avoid condensation.
- Use insulation that can withstand at least 120°C.

Principle:

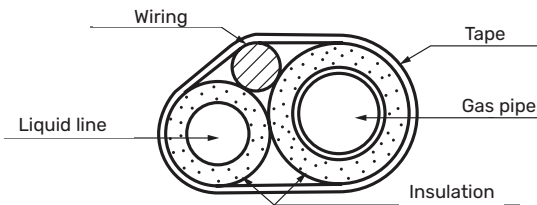

Connections:

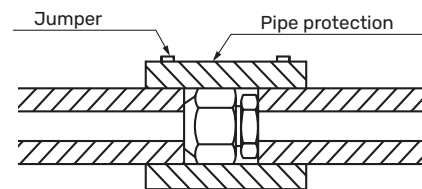

NOTE!

All connections and work related to the refrigeration system must be carried out by a person with the proper authorisations and certificates.

INSTALLATION REQUIREMENTS

Indoor unit SHK	SHK 20-200/6	SHK 20-200/12
Compatible outdoor module	L6.1	L10.1
Maximum pressure, climate system	0,3 MPa (3 Bar)	
Minimum pressure, climate system	0,05 MPa (0,5 Bar)	
Highest recommended supply / return temperature at dimensioned outdoor temperature	+55/+45°C	
Max. supply temperature in the SHK	+70°C	
Minimum temperature ext. operation of the unit	-20°C	
Minimum temperature ext. cooling operation	+10 °C	
Max flow line temperature with compressor	+58°C	
Min supply temperature cooling	+7°C	
Max supply temp. cooling	+25°C	
Min flow, climate system, 100 % circulation pump speed (defrosting flow)	0,19 l/s	
Min volume, climate system during under floor cooling*	50 l	80 l
Max flow, climate system	0,29 l/s	0,38 l/s
Min flow, heating system	0,09 l/s	0,12 l/s
Min flow, cooling system	0,11 l/s	0,16 l/s

* Refers to volume associated with undisturbed flow.

Connection options

Docking the indoor unit

The SHK 20-200 unit is not equipped with a shut-off valve for the central heating system, it must be installed on the outside of the indoor unit to allow any future servicing. Remember to protect the unit with a particulate filter.

Docking without heat pump

It is not necessary to change the configuration of the hydraulic connections for the indoor unit to work independently without the outdoor unit. The unit is equipped with an additional heater that can be used as the main heat source when there is no outdoor unit.



Connecting cold and hot water

The hot water tank should be connected to a water supply system with water pressure of min. 1 bar, max. 10 bar. If the pressure at the cold water inlet to the tank is higher than the permissible level, use a pressure reducer. During heating of the water in the tank, the pressure increases, which is why each tank must be equipped with the appropriate safety valve, installed on the cold water supply, which will protect the tank against an excessive increase in pressure. If using hot water circulation, see subsection "Hot water circulation".

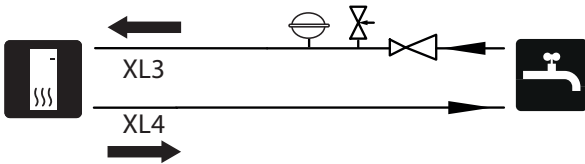

CAUTION!
It is absolutely necessary to install a properly selected safety valve on the cold water supply pipe.

CAUTION!
Do not use the appliance if the safety valve is blocked /damaged.

CAUTION!
It is forbidden to install any constrictors (e.g. reducers, particle filter, etc.) and shut-off valves between the storage tank and the safety valve. Only fitting a tee with a draining valve and a tee with an expansion vessel is permitted.

Docking the climate system

When connecting to a system with thermostatic valves on all radiators/underfloor heating circuits, use the appropriate hydraulic solutions which ensure the proper heating medium volume and minimum, undisturbed flow. See the subsection "Buffer vessel".



Connecting the 2-pipe cooling operation system

In the 2-pipe cooling operation system, the sensor BT64 / EQ1-BT25 assumes the function of sensor BT25. Degree minutes are counted according to EQ1-BT25. The BT25 and EQ1-BT25 sensors should be moved to the installation according to the diagram.

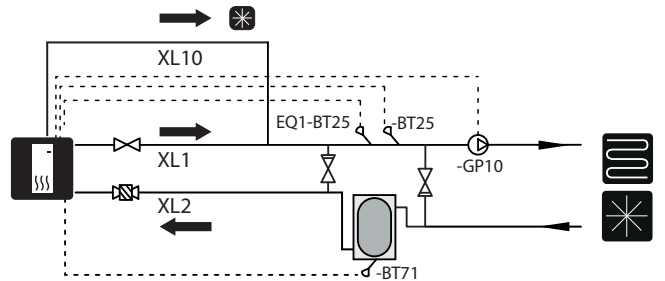

CAUTION!
The hydraulic system and all its components should be suitable for heating and cooling and have appropriate thermal insulation (allowed for cooling).

Connecting the 4-pipe cooling operation system

The 4-pipe system requires an additional cooling buffer vessel. Sensor BT64 must be transferred to the buffer vessel. Degree minutes for heating are counted according to BT25. Degree minutes for cooling operation are counted according to BT 64.

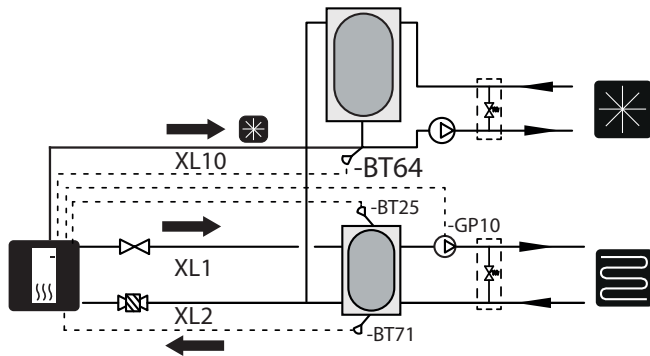

CAUTION!
The heat pump should have cooling insulation and the operating mode of the GP12 circulation pump should be set to intermittent mode.

Connecting the 4-pipe cooling operation system and pool heating

In case the installation in the building requires 4-pipe cooling and pool heating, the controller allows it to be implemented according to the following hydraulic diagram (QN12 valve must be installed before QN19 valve)

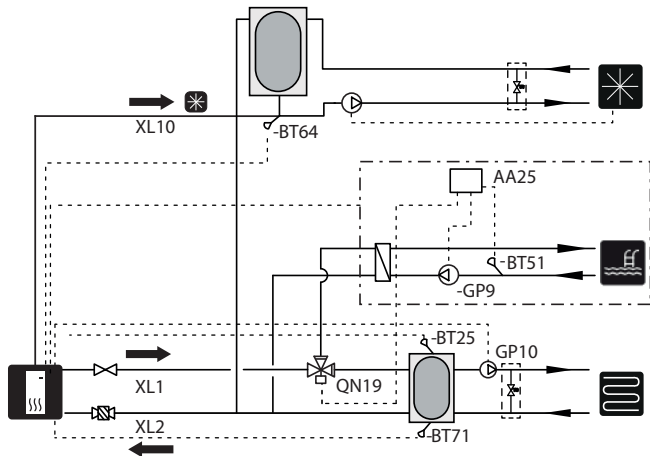

and the scheme according to menu 5.2.3:

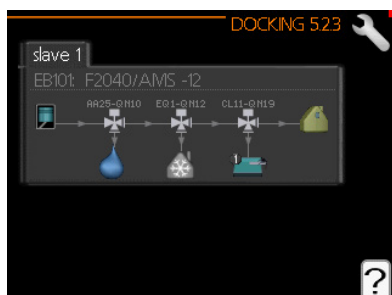

The connection of the QN19 valve is described in the manual of the POOL 40 accessory.

Docking an additional climate system

The system can be expanded to include additional heating/cooling circuits, provided an additional accessory board is used. Once the AXC 40 card or ready-to-use ECS 41 kit has been put into use, an additional heating/cooling circuit can be activated using the controller.

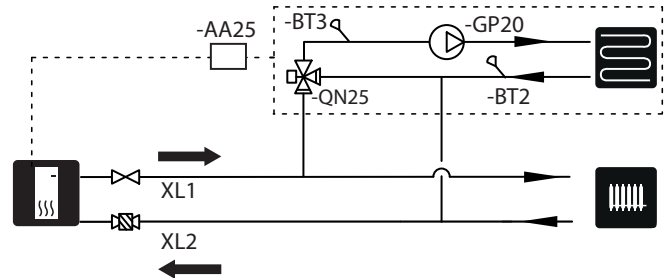

Additional accessories and the connection options and methods for these are described in the instructions for AXC 40 and ECS 41.

Buffer circuit

When connecting to a system with thermostatic valves on all radiators/underfloor heating pipes, use the appropriate hydraulic solutions which ensure the proper heating medium volume and minimum, undisturbed flow. See the subsection "Buffer vessel" and "Minimum system flow".

In the case of a system equipped with a buffer installed in parallel, the BT25 sensor should be installed in the buffer or in a place that ensures a correct reading of the supply temperature to the heating system. In order to correctly read the return temperature, it is recommended to move the BT71 sensor to the lower part of the buffer or to the return pipeline of the heating installation.

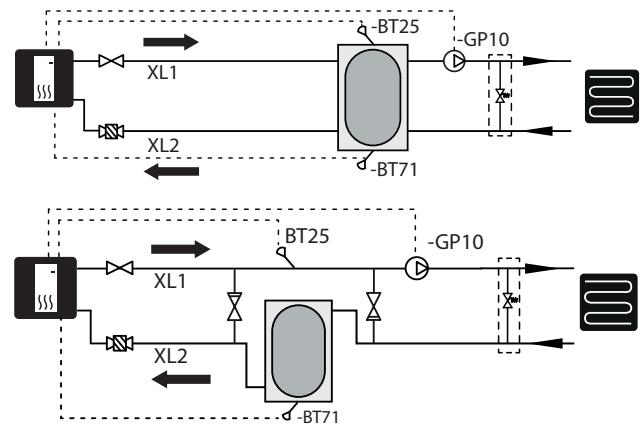

DHW circulation

CAUTION!
If connection AA3: X7 is used for another purpose, an additional AXC 40 is required to connect the hot water circulation pump control.

The SHK 20-200 have possibility to connect DHW circulation. The circulation connection (XL5) is located at the top of the tank.

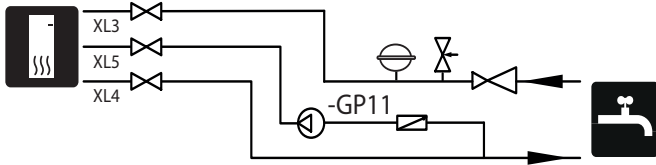

To connect the circulation:

1. Remove the XL5 plug from the top of the housing.

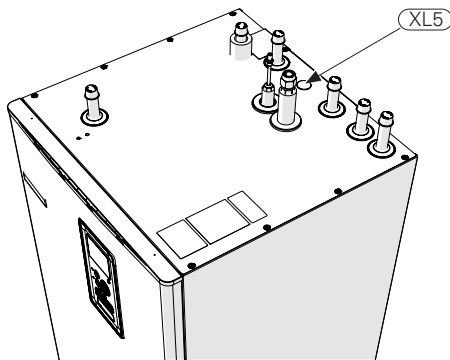

2. Remove the front panel, then move the control box to the right to gain access, to the hydraulic connections.

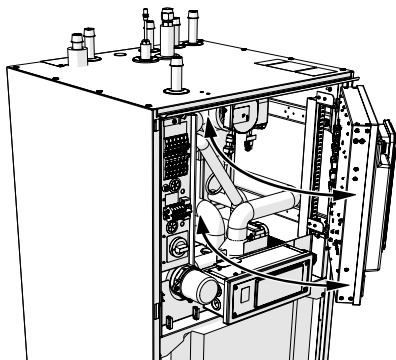

3. Remove the plug from the circulation pipe (XL5).
4. Install the elbow (not included in the SHK 20-200 device) facing the rear housing, on the circulation pipe.

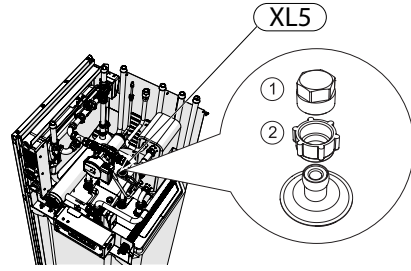

5. Connect the pipe to the elbow, with the dimensions shown in the figure below, leading pipe in the top of the housing, in place of the XL5 plug.
6. Install the circulation pump on the pipe outlet of the SHK 20-200 device, and then connect its control to the controller or AA5 card.
7. Install the control box and the front panel.

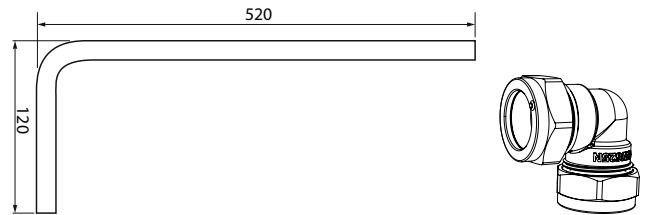

Dimensions of the pipe for circulation

Elbow 15x15

Connecting the control of the hot water circulation pump

The hot water circulation pump can be connected in two configurations:

- to board AA3: X7 (potential free relay; max. 2 A), on terminal block AA3-X7: NO (230 V), and N and PE on terminal block X1.

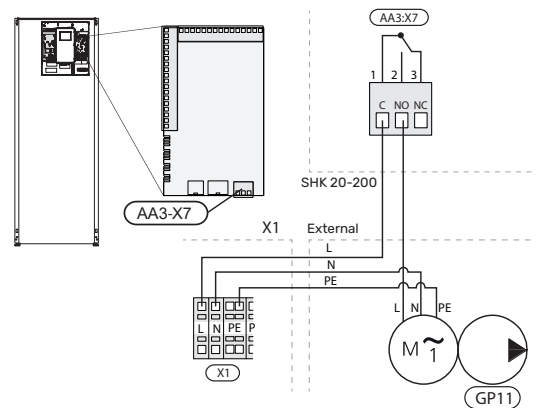

- in case AA3:X7 output is already in use, to accessory board AA5 (not included in SHK 20-200) on block AA5-X9:8 (230V), AA5-X9:7 (N) and X1:PE

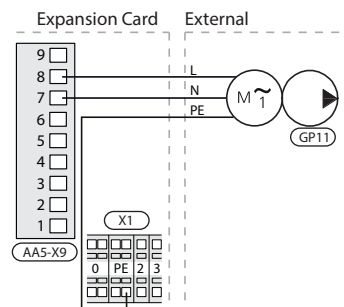

See the AA5 expansion card manual for more information.

5 METROAIR L outdoor unit

Transport and storage

METROAIR L must be transported and stored vertically.



CAUTION!

Ensure that the heat pump cannot fall over during transport.

Assembly

- Place METROAIR L outdoors on a solid level base that can take the weight, preferably a concrete foundation. If concrete slabs are used they must rest on asphalt or shingle.
- The concrete foundation or slabs must be positioned so that the lower edge of the evaporator is at the level of the average local snow depth; however, a minimum of 300 mm. Stands and attachments on the page are available in the METROAIR L instruction in the „Accessories“ chapter.
- METROAIR L should not be positioned next to noise sensitive walls, for example, next to a bedroom.
- Also ensure that the placement does not inconvenience the neighbours.
- METROAIR L must not be placed so that recirculation of the outdoor air can occur. This causes lower output and impaired efficiency.
- The evaporator should be sheltered from direct wind, which negatively affects the defrosting function. Place METROAIR L protected from wind against the evaporator.
- Large amounts of condensation water, as well as melt water from defrosting, can be produced. Condensation water must be led off to a drain or similar (see subsection „Condensation water drain“).
- Care must be exercised so that the heat pump is not damaged during installation.

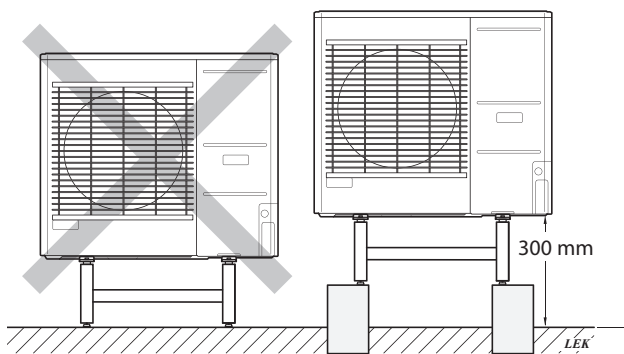

Do not place the METROAIR L heat pump directly on the lawn or other unstable surface.

For details on installing the outdoor unit, refer to the installer manual of the outdoor unit.

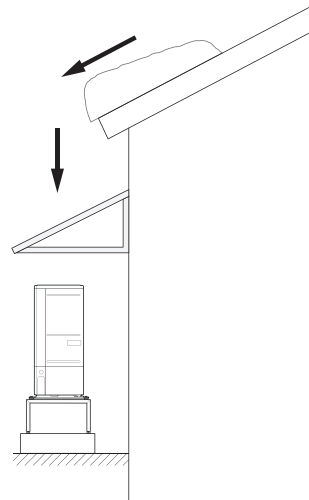

If there is a risk of snow slip from roof, a protective roof or cover must be erected to protect the heat pump, pipes and wiring.

Lift from the street to the set up location

If the base allows, the simplest thing is to use a pallet truck to move the METROAIR L to the set up location.



CAUTION!

The centre of gravity is offset to one side (see print on the packaging).

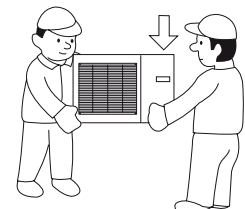
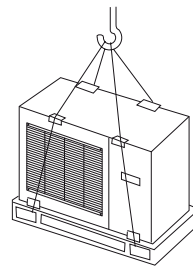

If METROAIR L needs to be transported across soft ground, such as a lawn, we recommend that a crane truck is used that can lift the unit to the installation location. When METROAIR L is lifted with a crane, the packaging must be undamaged and the load distributed with a boom, see the illustration above.

If a crane cannot be used METROAIR L can be transported using an extended sack truck. METROAIR L must be used on the side marked „heavy side“ and two people are required to get the METROAIR L up.

Lift from the pallet to final positioning

Before lifting, remove the packaging and the strap securing the product to the pallet.

Place lifting straps around each foot of the appliance.

Lifting from the pallet to the base requires four persons, one for each lifting strap.

It is not permitted to lift the appliance by anything other than the feet

Scrapping

In case of scrapping, the product is dismantled by performing the above actions in reverse order. Lift by the bottom panel instead of a pallet!

Condensation water drain

Condensation drains out on to the ground below METROAIR L. To avoid damage to the house and heat pump, the condensation must be gathered and drained away.



CAUTION!

Condensation drainage is important for the operation of the heat pump. The condensation drain must be routed such that it cannot damage the building.



CAUTION!

Do not connect heating cables with automatic adjustment.



CAUTION!

The electrical installation and wiring must be carried out under the supervision of an authorised electrician.

- Condensate (50 l / 24 hours) is drained off via the hose to the appropriate drain. It is recommended that the route outside for the condensate is as short as possible.
- The section of the pipe that may be affected by frost must be heated by the heating cable to prevent freezing.
- Route the pipe downward from the METROAIR L heat pump.
- The outlet of the condensation pipe must be at a depth that is frost-free or, alternatively, indoors (subject to local rules and regulations).
- Use a siphon for installations where air circulation may occur in the condensation water drainage pipe.
- The insulation must be tightly fitted to the bottom of the condensation water trough.

Recommended for leading off condensation water

Indoor drain

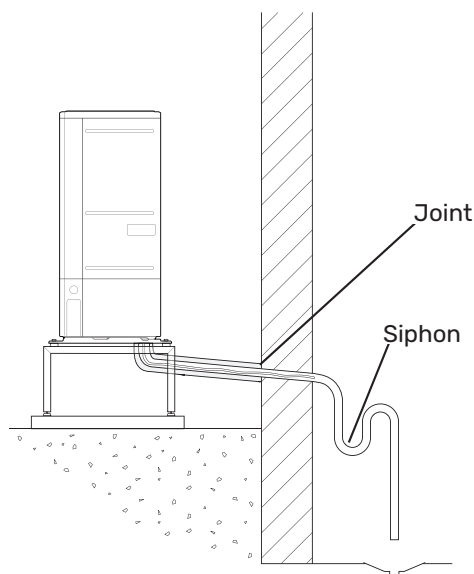

The condensation water is discharged to an indoor drain (subject to local rules and regulations).

Route the pipe downward from the air/water heat pump.

The condensation water drainage pipe must have a water seal to prevent air circulation in the pipe.

Stone caisson

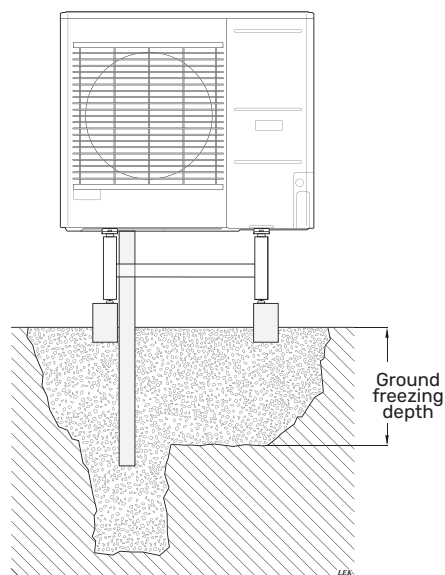

If the building has a basement, use a stone caisson to prevent condensation from damaging the building. Otherwise, the stone caisson can be positioned directly under the heat pump.

The outlet of the condensation water drainage pipe must be at a depth that is frost-free.

Drain into the gutter



CAUTION!
Bend the hose to create a siphon, see illustration.

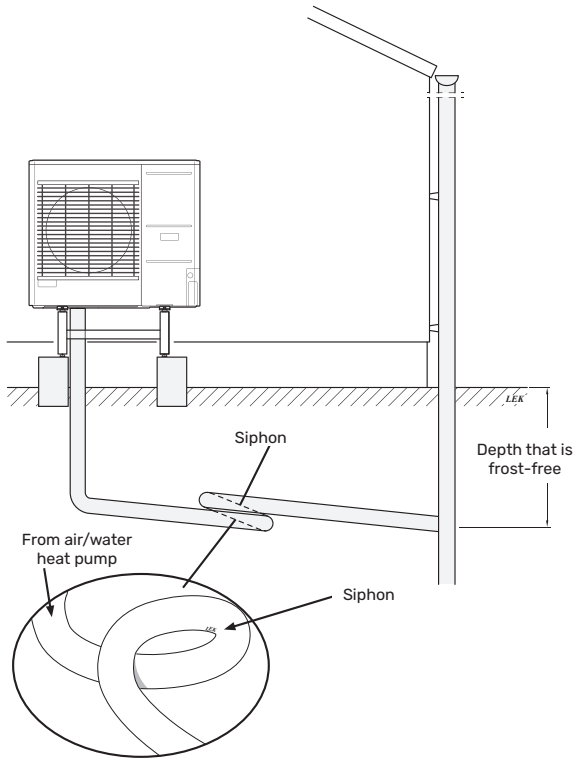

- The outlet of the condensation water drainage pipe must be at a depth that is frost-free.
- Route the pipe downward from the air/water heat pump.
- The condensation water drainage pipe must have a siphon to prevent air circulation in the pipe.
- The installation length can be adjusted by the size of the siphon.



NOTE!
If none of the recommended options will be used, proper drainage of condensate must be ensured.

Maintenance of METROAIR L

REGULAR CHECKS

Your SPLIT box only requires minimal maintenance. The condensation hose should be checked to ensure that condensation can run out to a drain. If there is any suspicion of leakage, pipe connections on METROAIR L should be checked.

Checking grilles and bottom panel on METROAIR L

Check that the inlet grille is not clogged by leaves, snow or anything else regularly throughout the year.

You should be vigilant during windy conditions and/or in the event of snow as the grilles can become blocked.

Also check that the drain holes in the bottom panel (three) are free from dirt and leaves.

Regularly check that condensation is routed away correctly through the condensation pipe. Ask your installer for assistance if required.

Dimensions

L6.1

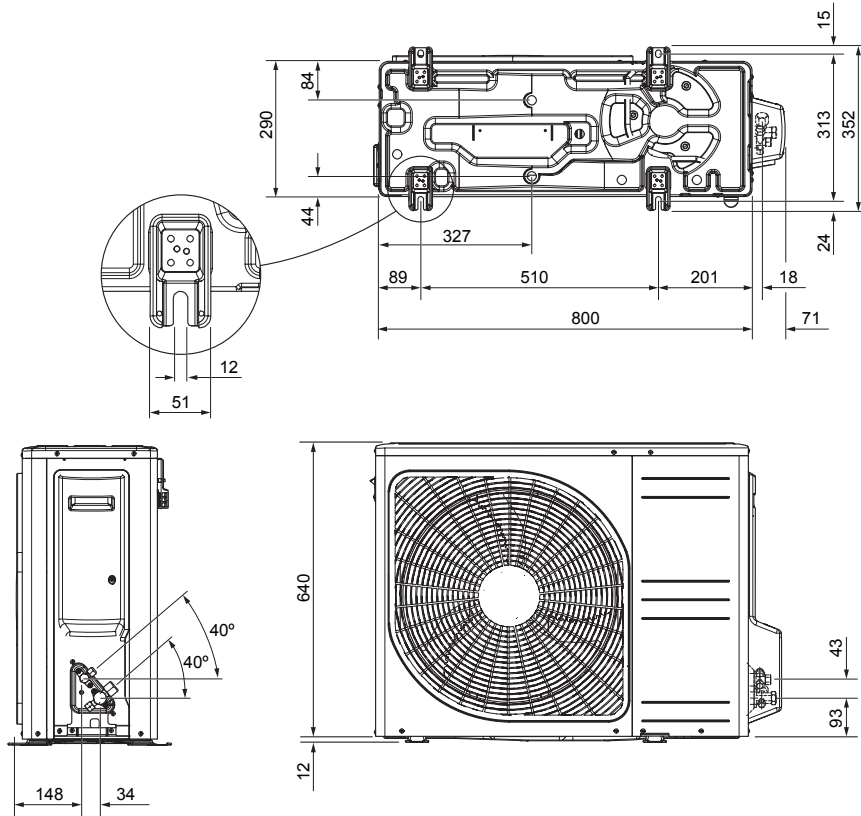

L10.1

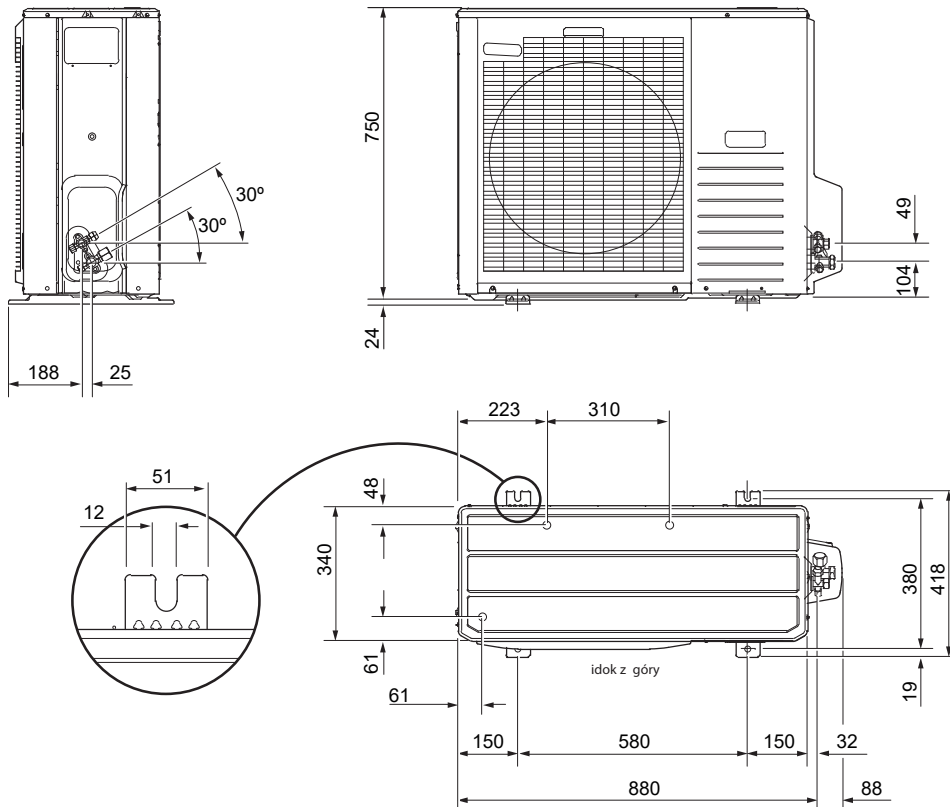

Installation location

The recommended distance between METROAIR L and the building wall should be at least 15 cm. Free space above

METROAIR L should be at least 100 cm. However, the free space from the front must be 100 cm for future servicing.

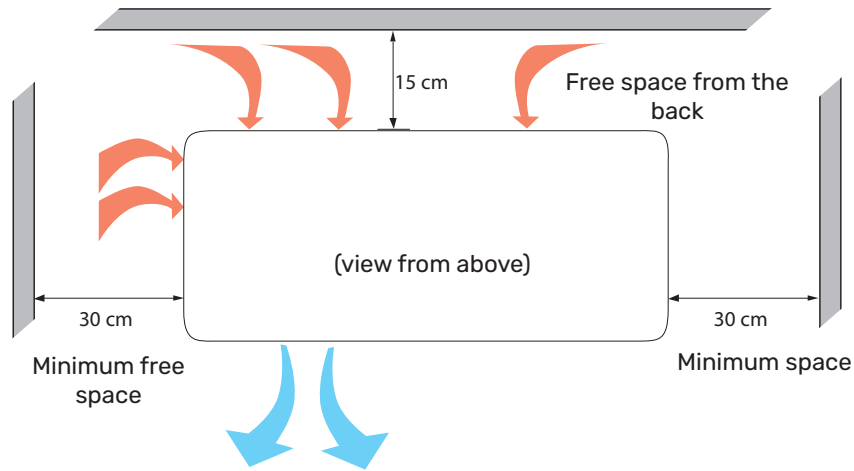

However, the free space from the front must be 100 cm for future servicing.

Sound power levels

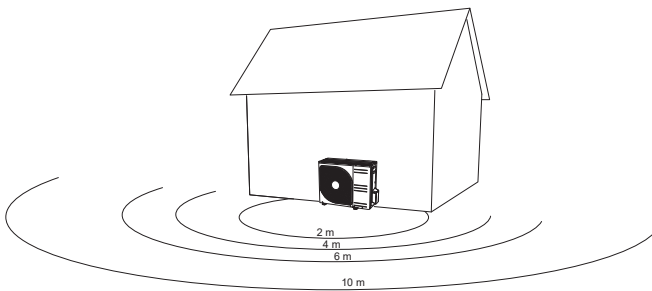

METROAIR L is usually placed next to a house wall, which gives a directed sound distribution that should be considered. Accordingly, you should always attempt to find a placement on the side that faces the least sound sensitive neighbouring area.

The sound pressure levels are further affected by walls, bricks, differences in ground level, etc and should therefore only be seen as guide values.

		Sound power ₁	Sound pressure at distance (m) ₂									
			1	2	3	4	5	6	7	8	9	10
L6.1	Nominal sound value	54	49,0	43,0	39,5	37,0	35,0	33,5	32,1	31,0	29,9	29,0
	Max. sound value	62	57,0	51,0	47,5	45,0	43,0	41,5	40,1	39,0	37,9	37,0
	Max. sound value, silent mode	54	48,0	42,0	38,5	36,0	34,0	32,5	31,1	30,0	28,9	28,0
L10.1	Nominal sound value	54	49,0	43,0	39,5	37,0	35,0	33,5	32,1	31,0	29,9	29,0
	Max. sound value	65	60,0	54,0	50,5	48,0	46,0	44,5	43,1	42,0	40,9	40,0
	Max. sound value, silent mode 60 Hz	54	49,0	43,0	39,5	37,0	35,0	33,5	32,1	31,0	29,9	29,0

¹ Sound power level, LW(A), according to EN12102

² Sound pressure calculated according to directivity factor Q=4

6 Electrical connections

General information

All electrical equipment, except the outdoor temperature sensor, room sensor are already connected at the factory.

- Disconnect the indoor module before performing tests of electrical system insulation in the building.
- If the building is equipped with a differential switch, SHK 20-200 must be equipped with a separate switch.
- The diagram of indoor module connections can be found in section „Electrical wiring diagrams“.
- Do not lay communication and signal cables to external contacts near voltage cables.
- Minimum cross-section of communication and signal cables to external contacts must total 0.5mm² with the length of up to 50 m, for example EKKX or LiYY, or similar.
- The power supply cable should be dimensioned according to the current standards.
- Use the UB1 cable grommet (as marked in the illustration) to lead the cables to the SHK 20-200. In the UB1 grommet, the cables are routed through the entire indoor unit from the rear wall towards the front.

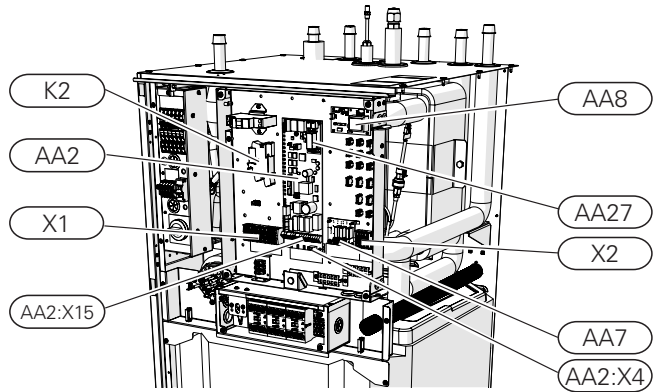
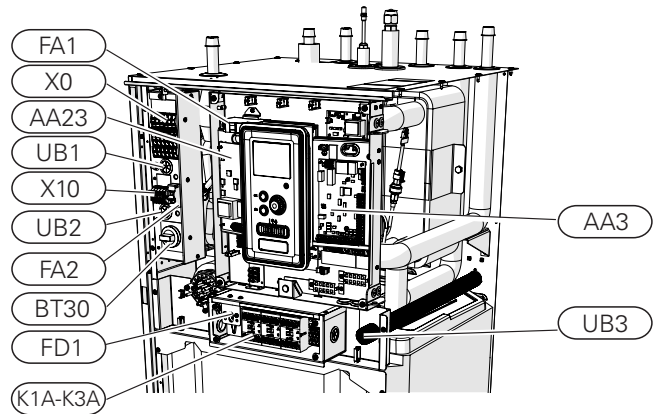

CAUTION!
The switch (SF1) for the controller must not be set to "I" or "Δ" until the climate system has been filled with heating medium and vented. Otherwise, the thermal circuit breaker, thermostat and the electric additional heat may be damaged.

CAUTION!
Cut off the power using the circuit breaker before carrying out any servicing. Electrical installation must be carried out in accordance with the current regulations by a person with the proper authorisations and qualifications.

CAUTION!
When SF1 is set to „Δ“ - the SHK 20-200 unit switches the QN10 valve to the central heating and heating takes place according to thermostat BT30. Hot water is not heated while the switch is set to „Δ“.

CAUTION!
If the system is operating at "Δ" the temperature on BT30 should be aligned with the operating temperature of the central heating system. If the temperature set on the thermostat is too high, it can damage the system.

X0	Power terminal - 230V~ / 400V~
X1	Control panel terminal block
X2	Control panel terminal block
X10	Outdoor unit connection terminal - 230 V~
FA1	Miniature circuit breaker (protecting the control system of indoor unit)
K1A-K3A	Electric additional heat contactor
BT30	Standby mode thermostat
AA3	Sensor card
AA23	Communication card
AA7	Relay board
FA2	Miniature circuit breaker (protecting the outdoor unit)
FD1	Thermal circuit breaker STB
UB1-UB3	Cable grommet
K2	Alarm relay
AA2	Main board
AA2:X15	Terminal block - low voltage
AA2:X4	Terminal block - low voltage
AA8	Titanium anode card
AA27	Relay board

Thermal circuit breaker STB

Temperature limiter STB (FD1) cuts off the power supply of the electrical heating module if the temperature increases to the range of approximately 92-6°C.

CAUTION!
In case of activation of the STB temperature limiter, it must be reported to an authorized service in order to diagnose the possible cause of its activation.

Resetting

The thermal circuit breaker (FD1) is accessible behind the front cover. It is reset by pressing firmly on the button (FD1-SF2) using a small screwdriver. Press the button using max. force 15 N (approx. 1.5 kg).

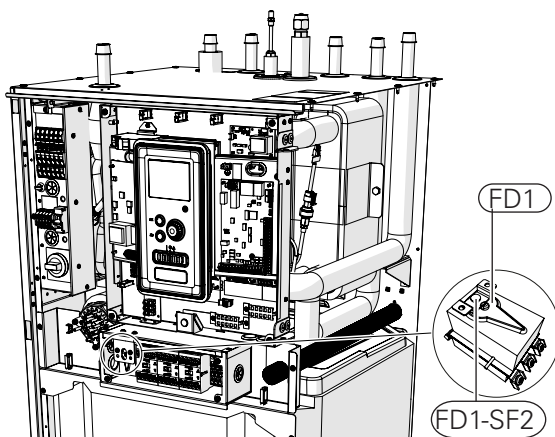

Cable key lock

Use a suitable tool to release/lock the cables in the terminal blocks of the indoor unit.

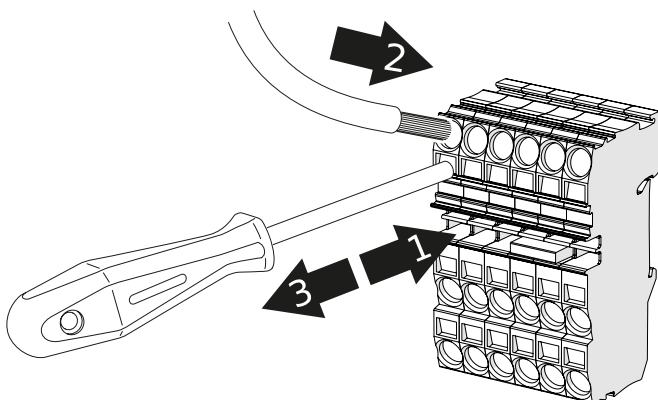

Connections

CAUTION!
External overcurrent protection should be selected by an appropriately qualified installer, based on the technical data contained in the manual, in accordance with the installed equipment system.

CAUTION!
The indicated cross-sections of power cables are recommended for cables laid on the wall with a length not exceeding 40 m. The selection of cables/sections and their arrangement should be consulted with a qualified electrician each time.

CAUTION!
To prevent interference, unscreened communication cables and/or sensor cables to external connections must not be laid at a distance less than 20 cm from voltage cables.

CAUTION!
The electrical system to which the device will be connected should be built in accordance with current regulations.

Power supply connection 400 V

The power supply connection is connected to terminal block (X0) through the input on the back of the unit (UB1). The cable must be dimensioned according to the applicable standards.

The 400V connection allows for a maximum power of 9kW to the electric additional heat. The connection should be made according to the diagram in the user manual.

Detailed electrical diagram - see subsection "Electrical wiring diagrams".

Diagram - connecting power supply 400 V

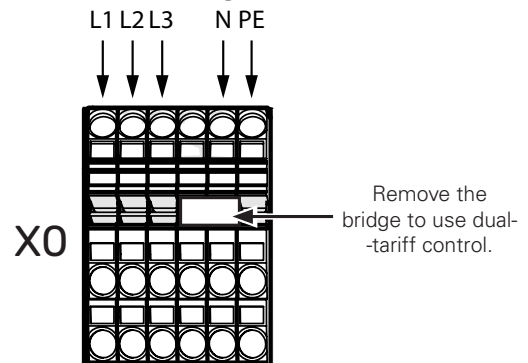

CAUTION!
If a 400V connection is used, the maximum power of the electric additional heater placed in the SHK 20-200 unit is 9 kW.



CAUTION!

In the case of dual-tariff control by the power company, it is recommended to connect the neutral wire from the power circuit (meter).

Power supply connection 230 V

The power supply connection is connected to terminal block (X0) through the input on the back of the unit (UB1). The 230V connection allows for a maximum power of 4,5 kW to the additional heating. The connection should be made according to the diagram in the user manual. Detailed electrical diagram - see subsection "Electrical wiring diagrams".

Diagram - connecting power supply 230 V

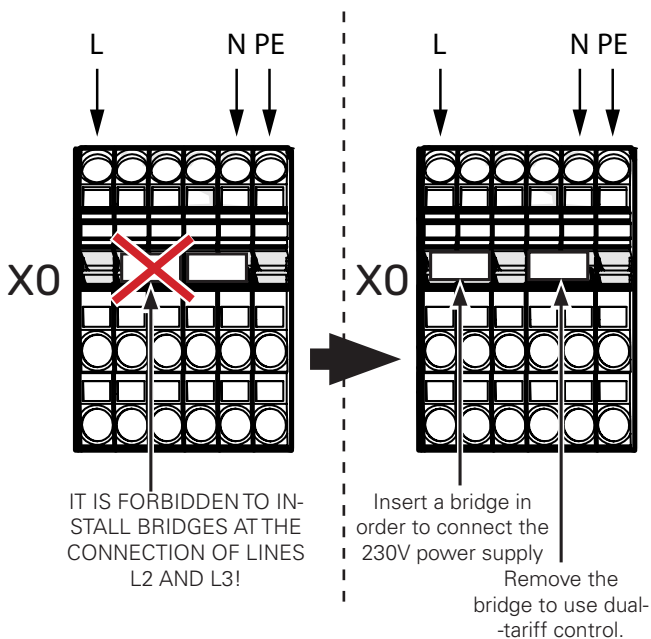

CAUTION!

When a 230V connection is used, the maximum power of the additional heat used in the SHK 20-200 unit is 4.5kW.



CAUTION!

In the case of a dual tariff power supply by the power company, it is advisable to connect the neutral wire from the power supply circuit (meter) - particularly when using a 230 V connection.



CAUTION!

It is forbidden to install bridges at the connection of lines L2 and L3. Otherwise, the appliance and the electrical system may be damaged.

The manufacturer is not liable for any damage caused by failure to comply with the above instructions.

Miniature circuit breaker

The automatic heating control system, the circulation pump and their wiring in SHK 20-200 are internally protected by miniature circuit breaker C10 (FA1). The METROAIR L outdoor unit and accessories are internally protected in SHK 20-200 by miniature circuit breaker B20 (FA2).



CAUTION!

The electrical installation should also have an additional power switch to disconnect the main power supply to the unit.

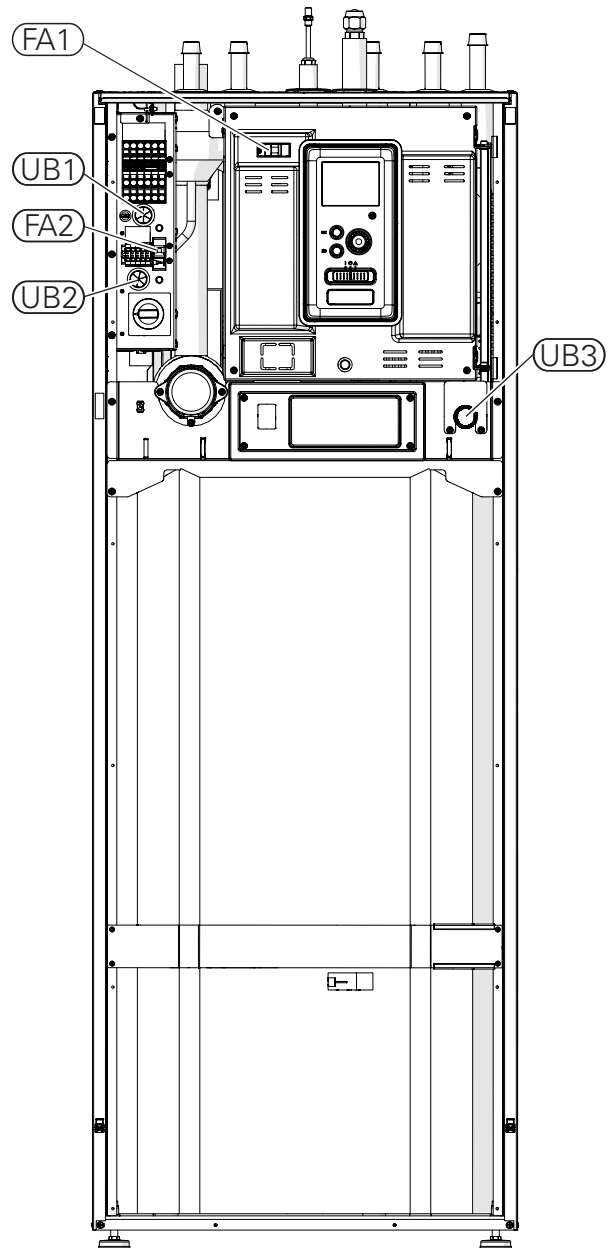

Connecting SHK 20-200 and METROAIR L

The device connecting cable should be connected to the power supply terminal block (TB) in METROAIR L and to the terminal block (X10) in SHK 20-200 .

CAUTION!
Wiring must be secured so that the terminal block is not under tension. The end of the wire should be 8 mm long without insulation.

METROAIR L

Connect the phase (brown), neutral (blue), communication (black and grey) and protective (yellow-green) conductors as shown in the drawing:

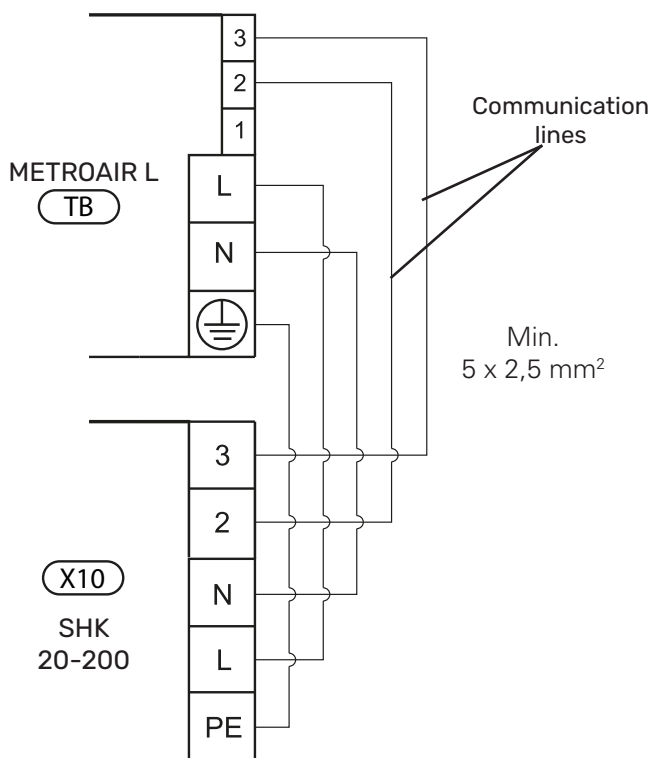

Additional connections

Connecting the outdoor temperature sensor

The outdoor temperature sensor BT1 (included) should be connected to the SHK 20-200 unit via terminal block AA3-X6:1 and AA3-X6:2.

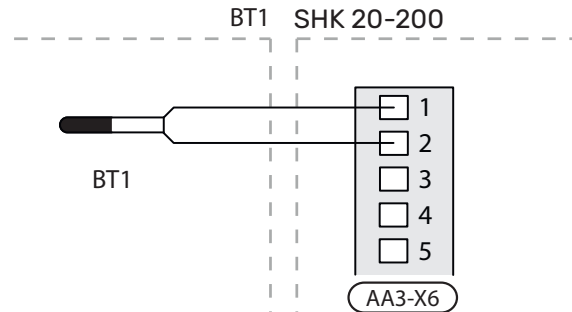

Connecting the indoor temperature sensor

The indoor temperature sensor BT50 (included) should be connected to the SHK 20-200 unit via terminal block AA3-X6:3 and AA3-X6:4.

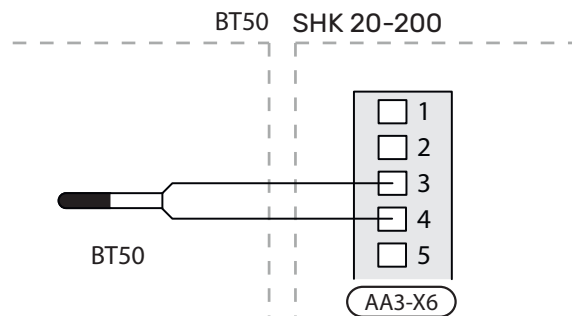

CURRENT SENSORS

When many power consumers are connected in the property at the same time as the electric additional heat is in operation, there is a risk of the property's main fuses tripping. Current meters controls the power steps for the electric additional heat by disconnecting step by step in event of overload in a phase. Reconnection occurs when other current consumption is reduced.

NOTE!

If current meters are installed, full functionality is obtained by enabling 'detect phase sequence' and changing the fuse size to 20A in menu 5.1.12.

Connecting current sensors



CAUTION!

If the current value (MENU 5.1.12) is set too low, it may cause the additional heat to be switched off, reduce the heat pump capacity and may affect the efficiency of the compressor.

A current sensor must be installed on each incoming phase conductor into the electrical distribution unit, to measure the current. The electrical distribution unit is an appropriate installation point.

Current meters should be connected to the four-wire cable in the distribution box. Between the housing and SHK 20-200, use a four-wire cable with a cross-section of min. 0.5mm².

Connect the cable to the input board (AA3) on terminal block X4:1-4 where X4:1 is the common terminal block for the three current sensors.

If the current value (MENU 5.1.12) is set too low, it may cause the additional heat to be switched off, reduce the heat pump capacity and may affect the efficiency of the compressor.

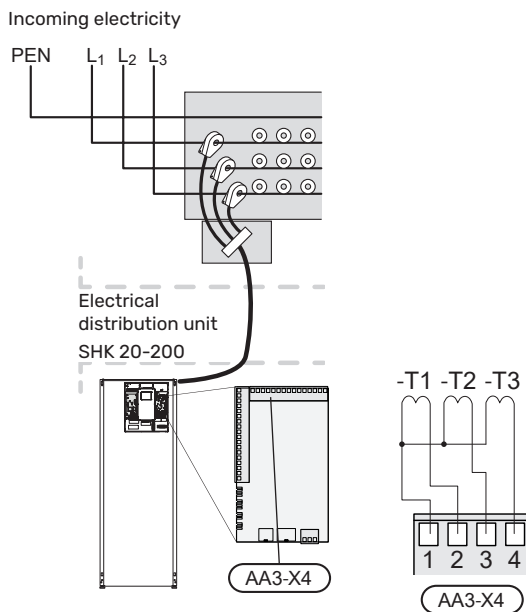

Settings

Electric additional heat- maximum power

The electric additional heat has a maximum power of 9 kW (400 V) / 4,5 kW (230 V). The power is split into 3 steps. The possible operational power steps are: 3, 6 and 9 kW (400 V) or 1,5, 3,0 and 4,5 kW (230 V). The maximum power step of the immersion heater can be set using menu 5.1.12.

Emergency mode

When the controller is set to emergency mode (SF1 is set to Δ) only the most necessary functions are activated.

- Hot water is not heated.
- Constant temperature in the supply line, more information in the section Emergency mode thermostat.



CAUTION!

While on emergency mode, it is not possible to heat hot water.

Emergency mode thermostat

The supply temperature in emergency mode is set using a thermostat (BT30). It should be set according to the demands of the heating/cooling circuits in operation.

The adjustment range is 5 - 65°C. Please note, however, that for underfloor heating the setting should be min. 20°C, max. 35-45°C to maintain comfort in the room and efficient operation of the system.

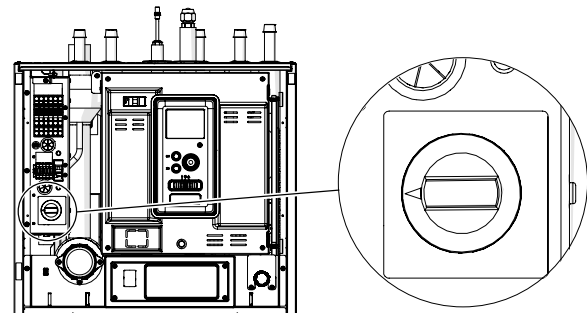

CAUTION!

The maximum available heater power in emergency mode is 3kW.



CAUTION!

The temperature on the thermostat must be set according to the system requirements. If the temperature is too high, it can damage the system.

7 Commissioning and adjusting

Preparations

1. Check that the switch for the control module is in position „“.
2. Check whether the drain valve has been completely closed, and whether the temperature limiter has not been activated (FD1).
3. Compatible air/water heat pumps have been listed in the Connection Options section.

Filling and venting

Heating water parameters

If the heating circuits are filled with heating water, the water must comply with the requirements of VDI Guideline 2035 parts 1 and 2.

To prevent corrosion damage, three basic parameters of water composition must be controlled:

1. dissolved oxygen content,
2. electrical conductivity and
3. pH.

Oxygen content and electrical conductivity are related such that lower conductivity allows higher O₂ content without fear of increased corrosion. Similarly, higher conductivity can result in increased susceptibility to corrosion even at relatively low O₂ saturation levels.

The following guidelines are therefore recommended:

4. Heating water with a low salt concentration - i.e. where the electrical conductivity of the system water is less than 100 µS/cm - the dissolved O₂ content should be less than 0.1 mg/l.
5. Heating water with a high salt concentration - i.e. where the electrical conductivity of the system water is between 100 µS/cm and 1500 µS/cm - the dissolved O₂ content should be less than 0.02 mg/l.

In both cases, the pH value of the heating water should remain between 8.2 and 10.

In order to prevent damage due to boiler scale, the following water composition parameters must be controlled:

System thermal output [kW]	System capacity [l/kW]	Alkali earth element content [mol/m ³]	Hardness [°d]
≤ 50	≤ 20	no requirements	no requirements
	from 20 to 50	≤ 2,0	≤ 11,2
from 50 to 200	≤ 20	≤ 2,0	≤ 11,2
	from 20 to 50	≤ 1,5	≤ 8,4

NOTE!

The above parameters for heating water are recommended values. If national regulations state otherwise, they shall prevail over the recommendations contained in this manual.

Filling the DHW heater at SHK 20-200

1. Open the hot water tap in the building to the tank.
2. Open the valve cutting off cold water. When doing so, the valve should be completely open.
3. When water starts to flow from the intake point with hot water without air bubbles, the HW tank is full and you can close the intake point.

Filling and venting the climate system and SHK 20-200

1. Open the vent valves at the highest point of the climate system.
2. Set all mixing valves to a position which allows flow in all heating/cooling circuits.
3. Open the valve for filling the climate system and fill it with the heating medium, vent the system.
4. Check the pressure gauge, on which an increase in pressure will be visible. Fill the system to the required pressure (1,5 - 2), then close the filling valve. The maximum operating pressure of the system is 3 bar.
5. Start the climate system circulation pump. The automatic vent valves located on the heating/cooling circuit will begin venting the system.
6. If during venting the pressure falls below 1 bar, extra heating medium must be added to the climate system.

Draining the climate system

To make it easier to carry out servicing on the climate system, drain the system first using the filling / draining valve. The unit is not fitted with a climate system drainage valve. This valve must be installed external from the product



CAUTION!

There may be some hot water when draining the heating medium side/climate system. There is a risk of scalding.

1. Connect a pipe to the system's external draining valve.
2. Then open the draining valve in order to drain the heating installation.

Circulation pump

Pump speed

The circulation pump in SHK 20-200 is controlled by frequency, and is automatically regulated via control and based on the heating / hot water demand.

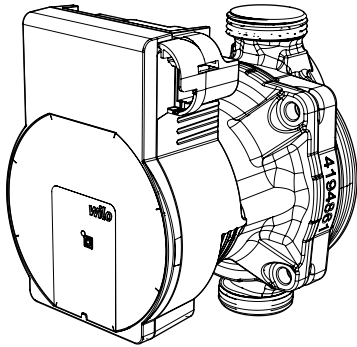

Available pressure, circulation pump GP12.

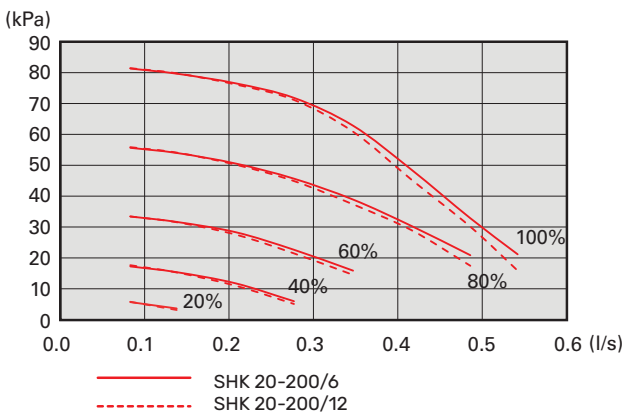

Post-adjustment, venting

Initially, air is released from the heating medium and venting may be necessary. If gurgling sounds can be heard from the climate system, the entire system will require additional venting. The system is vented via the vent valves. During venting, SHK 20-200 must be switched off.

Commissioning



CAUTION!

Commissioning of the system must be carried out by a person with appropriate authorizations and manufacturer's authorization!

For commissioning of the heat pump:

1. Switch on the power supply to SHK 20-200 making sure that the METROAIR L unit is properly connected to the power supply.
2. Follow the instructions displayed in the controller start guide.

Start Guide



CAUTION!

The climate system must be filled with water and vented before setting the switch to "I".

1. Set the switch (SF1) on the controller to "I".
2. Follow the instructions in the display's start guide. If the start guide does not start when you start the controller, start it manually in menu 5.7.



TIP!

For more detailed information on the plant controls (operations, menus, etc.) refer to Chapter 8 Control - Introduction.

Commissioning

The first time the system is started up, a start guide is launched. The start guide instructions state what needs to be carried out at the first start-up together with a run through of the system's basic settings.

The start guide ensures that start-up is carried out correctly. The start guide can be started later in menu 5.7.

After running the start guide, the reversing valves are open in both directions to help vent the heat pump.



NOTE!

As long as the start guide is active, no function in the controller will start automatically. The guide will appear at each controller restart until it is disabled on the last page.



NOTE!

If starting up the system in low outdoor temperature and a low heating medium temperature in the central heating system, the central heating system should be warmed up first, using the additional heat, to a temperature of about 20 - 25 °C.

Operating the start guide

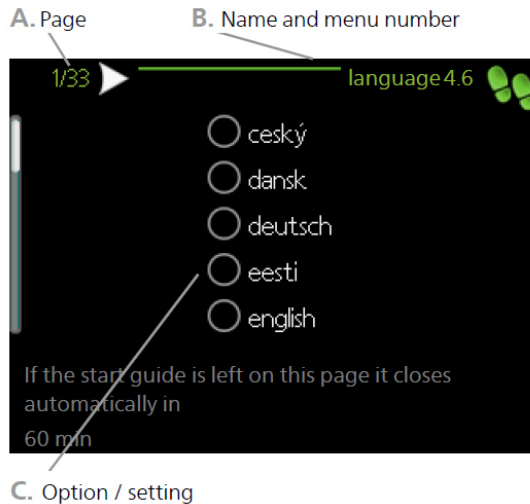

A. Page

Here you can see the menu level in the start guide. Scroll between the pages of the start guide as follows:

1. Turn the control knob until one of the arrows in the top left corner (at the page number) has been selected.
2. Press the OK button to skip between the pages in the start guide.

B. Name and menu number

Information about the menu page, to which the start guide refers, can be found in the control system. The digits refer to the menu number in the control system.

If you want to read more about a particular menu, either consult the help menu or read the user manual.

C. Option / setting

Enter settings for the system here.

D Help Menu



In many menus there is a symbol which indicates that extra help is available.

To view the help text:

1. Use the knob to select the help symbol.
2. Press the OK button.

The help text often consists of several windows that you can scroll between using the knob.

Commissioning without heat pump

The indoor unit can be used without a heat pump only as an electric boiler, to produce heat and hot water before the heat pump is installed, for example.

Go to menu 5.2 System settings and turn off the heat pump.



CAUTION!

Select the auto or manual operating mode when the indoor unit is to be used again with the heat pump.

Overflow valve

The overflow valve adjustment procedure applies to units with a flow meter installed. It should be carried out during system commissioning as follows:

1. Fully open the overflow valve.
2. Close the flow on all heating circuits downstream of the overflow valve.
3. Go to menu 5.6 Forced control and manually set the feed pump speed to 100%.
4. Go to menu 3.1.12.
5. At quarter turn intervals of one minute, close the pressure overflow valve while checking the flow reading in menu 3.1.12. When the „Minimum flow during defrosting“ value has been reached - see table in chapter 4, subchapter „Minimum flow in the system“, complete the valve closure.
6. You can then reopen the heating circuits and set the circulation pump to automatic mode in menu 5.6 Forced control.

8 Control - Introduction

Display unit

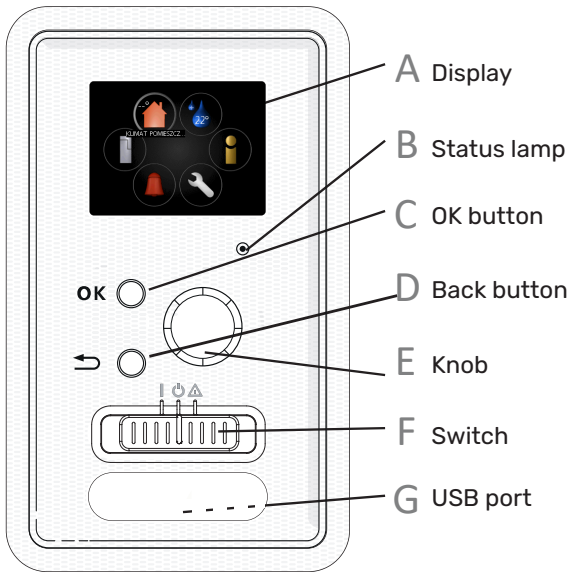

F Switch (SF1)

The switch offers three positions:

- On (I)
- Standby (⏻)
- Emergency mode (⚠)

Emergency mode must only be used in the event of a fault on the control module. In this mode, the compressor in the heat pump switches off and the immersion heater engages. The control module display is not illuminated and the status lamp illuminates yellow.

G USB port

The USB port is hidden beneath the plastic badge with the product name on it.

The USB port is used to update the software.

A Display

Instructions, settings and operational information are shown on the display. You can easily navigate between the different menus and options to set the comfort or obtain the information you require.

B Status lamp

The status lamp indicates the status of the control module. It:

- lights green during normal operation.
- lights yellow in emergency mode.
- lights red in the event of a deployed alarm.

C OK button

- The OK button is used to:
- confirm selections of sub menus/options/set values/page in the start guide.

D Back button

The back button is used to:

- go back to the previous menu.
- change a setting that has not been confirmed.

E Knob

The knob can be turned to the right or left.

You can:

- scroll in menus and between options.
- increase and decrease the values.
- change page in multiple page instructions (for example help text and service info).

Menu system

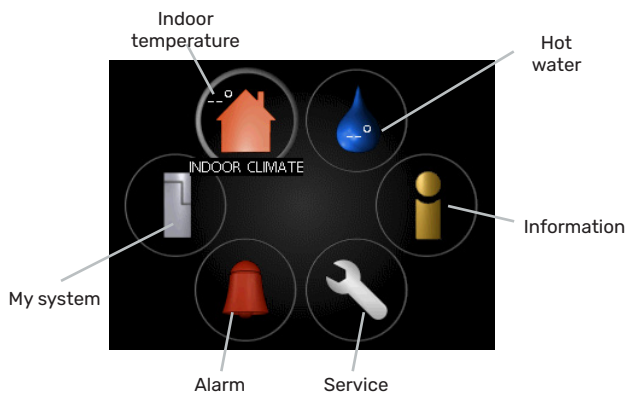

Menu 1 - INDOOR CLIMATE

Setting and scheduling the indoor climate. See information in the help menu or user manual in chapter MENU 1.

Menu 2 - HOT WATER

Setting and scheduling hot water production. See information in the help menu or user manual in chapter MENU 2.

Menu 3 - INFO

Display of temperature and other operating information and access to the alarm log. See information in the help menu or user manual in chapter MENU 3.

Menu 4 - MY SYSTEM

Setting time, date, language, display, operating mode etc. See information in the help menu or user manual in chapter MENU 4.

Menu 5 - SERVICE

Advanced settings. These settings are not available to the end user. The menu is visible when the Back button is pressed for 7 seconds, when you are in the start menu in chapter MENU 5.

Symbols in the display

The following symbols can appear in the display during operation.

Symbol	Description
	This symbol appears by the information sign if there is information in menu 3.1 that you should note.
	These two symbols indicate whether the compressor in the outdoor unit or additional heat in the installation is blocked via controller. These can, for example, be blocked depending on which operating mode is selected in menu 4.2, if blocking is scheduled in menu 4.9.5 or if an alarm has occurred that blocks one of them. Blocking the compressor Blocking additional heat
	This symbol appears if periodic increase or lux mode for the hot water is activated.
	This symbol indicates whether „holiday setting“ is active in 4.7.
	This symbol indicates whether the controller has contact with MyUplink.
	This symbol indicates the actual fan speed if these revolutions have been changed in relation to the normal setting. Required additional equipment ERS.
	This symbol indicates whether solar heating is active. Required additional equipment EME.
	This symbol indicates whether pool heating is active. Required additional equipment POOL 40.
	This symbol indicates whether cooling is active.

Operation

To move the check mark, turn the control knob to the left or the right. The marked position is white and/or has a turned up tab.



Selecting menu

To advance in the menu system select a main menu by marking it and then pressing the OK button. A new window then opens with sub menus.

Select one of the sub menus by marking it and then pressing the OK button.

Selecting options

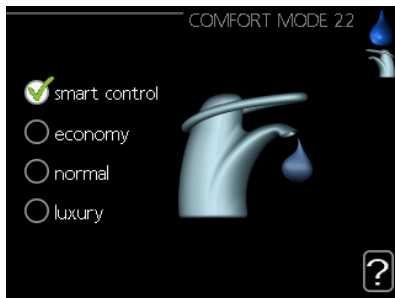

In an options menu the current selected option is indicated by a green tick.

To select another option:

1. Mark the applicable option. One of the options is pre-selected (white).
2. Press the OK button to confirm the selected option. The selected option has a green tick.



Setting a value



Values to be changed

To set a value:

1. Mark the value you want to set using the control knob.
2. Press the OK button. The background of the value becomes green, which means that you have accessed the setting mode.
3. Turn the control knob to the right to increase the value and to the left to reduce the value.
4. Press the OK button to confirm the value you have set. To change and return to the original value, press the Back button.



Use the virtual keyboard

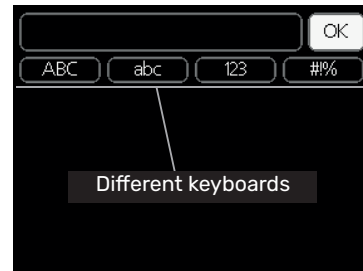

In some menus where text may require entering, a virtual keyboard is available.

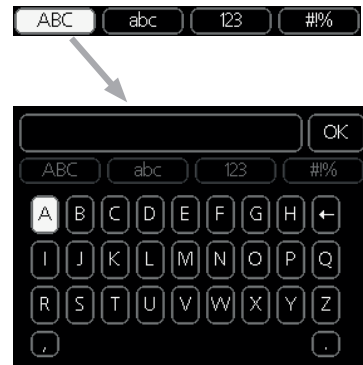

Depending on the menu, you can gain access to different character sets which you can select using the control knob. To change character table, press the Back button. If a menu only has one character set the keyboard is displayed directly. When you have finished writing, mark „OK“ and press the OK button.

Scroll through the windows

A menu can consist of several windows. Turn the control knob to scroll between the windows.

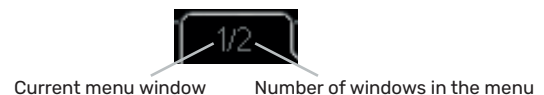

Scroll through the windows in the start guide



Arrows to scroll through window in start guide

1. Turn the control knob until one of the arrows in the top left corner (at the page number) has been marked.
2. Press the OK button to skip between the steps in the start guide.

Help menu

 In many menus there is a symbol that indicates that extra help is available.

To access the help text:

1. Use the control knob to select the help symbol.
2. Press the OK button.

The help text often consists of several windows that you can scroll between using the knob.

9 Control

Menu 1 - INDOOR CLIMATE

1-INDOOR CLIMATE	1.1 temperature	1.1.1 - heating	
		1.1.2 - cooling	
	1.2 - ventilation ¹		
	1.3 - scheduling	1.3.1 - heating	
		1.3.2 - cooling	
		1.3.3 - ventilation ¹	
	1.9 - advanced	1.9.1 - curve	1.9.1.1 - heating curve
			1.9.1.2 - cooling curve
		1.9.2 - external adjustment	
		1.9.3 - min. flow line temp.	1.9.3.1 - heating
			1.9.3.2 - cooling
		1.9.4 - room sensor settings	
		1.9.5 - cooling settings	
		1.9.6 - fan return time ¹	
	1.9.7 - own curve	1.9.7.1 - heating	
		1.9.7.2 - cooling	
	1.9.8 - point offset		

The above menu diagram may vary depending on the installed accessories.

¹ The ERS additional equipment is necessary.

Menu 2 - HOT WATER

2 - HOT WATER	2.1 - temporary lux	
	2.2 - comfort mode	
	2.3 - scheduling	
	2.9 - advanced	2.9.1 - periodic increase
		2.9.2 - hot water recirc. ²

Menu 3 - INFO

3 - INFO	3.1 - service info
	3.2 - compressor info
	3.3 - add. heat info
	3.4 - alarm log
	3.5 - indoor temp. log

The above menu diagram may vary depending on the installed accessories.

² The AXC 40 additional equipment is necessary.

Menu 4 - MY SYSTEM

4 - MY SYSTEM	4.1 - plus functions	4.1.1 - pool ³	
		4.1.2 - pool 2 ³	
		4.1.3 - internet	4.1.3.1 - Uplink
			4.1.3.8 - tcp/ip settings
			4.1.3.9 - proxy settings
		4.1.5 - SG Ready	
		4.1.6 - smart price adapt.	
		4.1.7 - smart home	
		4.1.8 - smart energy source	4.1.8.1 - settings
			4.1.8.2 - set. price
			4.1.8.3 - CO2 impact
			4.1.8.4 - tariff periods, electricity
			4.1.8.6 - tariff per, ext. shunt add
			4.1.8.7 - tariff per, ext. step add
			4.1.8.8 - tariff periods
		4.1.10 - solar electricity ⁵	
		4.2 - op. mode	
		4.3 - my icons	
		4.4 - time & date	
		4.6 - language	
	4.7 - holiday setting		
	4.9 - advanced	4.9.1 - op. prioritisation	
		4.9.2 - auto mode setting	
		4.9.3 - degree minute setting	
		4.9.4 - factory setting user	
		4.9.5 - schedule blocking	
		4.9.6 - schedule silent mode	

The above menu diagram may vary depending on the installed accessories.

³ The POOL 40 additional equipment is necessary.

⁵ The EME 20 additional equipment is necessary.

Start guide

CAUTION!
The Start Guide can only be edited by qualified personnel. Entering incorrect parameters may damage the heat pump.

The start guide appears when you first start the SHK 20-200. You can also enable the start guide in menu 5.7. The individual settings for the start guide factory settings are described below.

1/17 Language

In this menu, select the operating language of the controller.

Factory setting: english

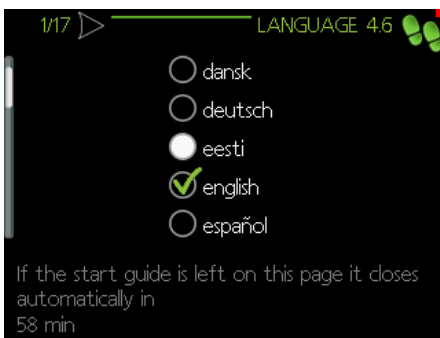

2/17 Information

This menu displays information about the start guide.

3/17 Country

Select where the product is to be installed here.

4/17 Flow. set. climate sys.

In this menu there is possibility to change settings for the essential settings of the heating system. More information after selecting „?”.

Factory setting: presetsings
Factory setting:radiator
Factory setting:-15.0 DOT C

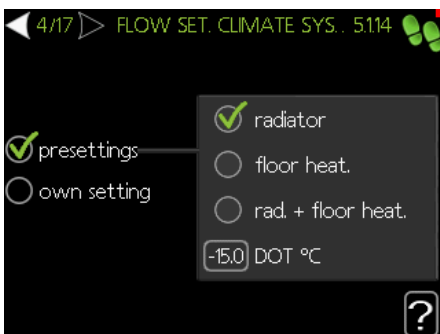

5/17 Accessories

In this menu it is possible to activate additional connected accessories. More information after selecting „?”.

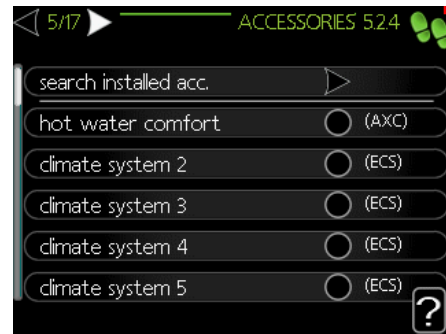

6/17 Room sensor settings

In this menu you can activate and change settings for the room sensor. More information after selecting „?”.

Factory setting: inactive

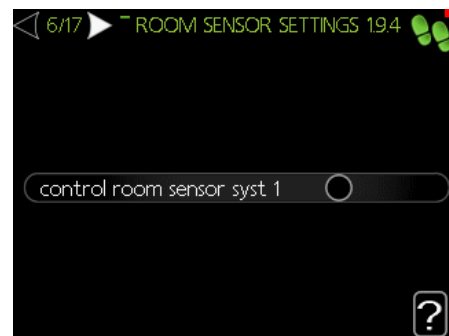

7/17 Control of external sensors

In this menu we have the possibility to check the allowed values for external sensors. More information after selecting „?”.

8/17 Internal electrical ad

In this menu we have the option to change settings for the additional heat (built-in electric additional heat). More information after selecting „?”.

Factory setting:
 3x400 V incoming power: active (for 3 phases)
 set max electrical add.: 9,0 kW
 fuse size: 20 A
 transformation ratio: 300
 detect phase order (displayed if 3x400 V incoming power is activated.)

CAUTION!
 In the case of a fuse rating with a smaller value (applies to the main fuse rating in the house) you should set this value lower than 20 A. Note, this will reduce the power of the appliance. You cannot set a value higher than 20 A for 400 V connection or 40 A for 230 V connection.

NOTE!
 If the 3x400 V incoming power is active and current sensors are connected, the detect phase order function must be activated.

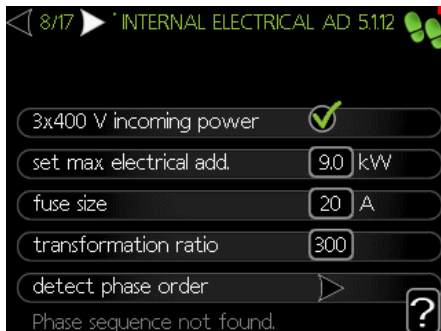

9/17 Installed slaves

The menu has an informative function. You can select one device.

To view more information, select „?”.

Factory setting:
 slave 1: active (EB101)

CAUTION!
 The SHK 20-200 unit cannot be cascaded with heat pumps.

10/17 Time & date

In this menu, set the current date and time. In addition, we have the ability to choose the display format and time zone.

11/17 Min. flow line temp.

In this menu it is possible to edit the minimum flow temperature of the heating system. More information after selecting „?”.

Factory setting:
 climate system 1: 20 C

12/17 Max flow line temp.

In this menu it is possible to edit the maximum flow temperature of the heating system. More information after selecting „?”.

Factory setting:
 climate system 1: 55 C

Recommended setting values are:
 + 35 for surface heating,
 + 55 for radiator heating.

13/17 Heating curve

In this menu it is possible to edit the heating curve specified for the SHK 20-200 unit. More information after selecting „?”.

Factory setting:
 Heating curve: 7

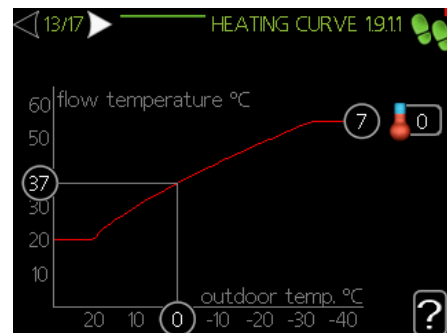

Detailed information on curve settings - see pt. „Control - Menus”.

14/17 Op. mode

In this menu, you can select the operating mode for the HV. 1Split unit. More information after selecting „?”.

Factory setting: auto

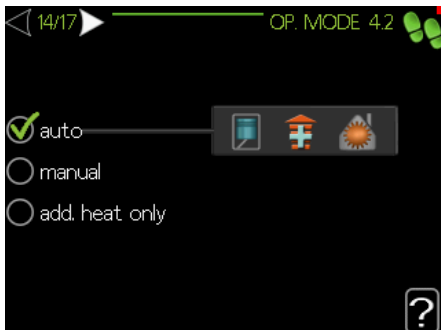

NOTE!

Recommended „auto” operating mode. Editing is only possible by qualified personnel.

15/17 Alarm actions

In this menu it is possible to activate alarm actions. More information after selecting „?”.

Factory setting:
decrease room temp: inactive
deactivate hot water: inactive

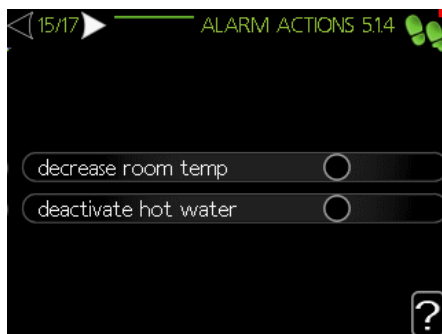

16/17 Reminder

Reminder to complete the checklist in the first chapter of the user manual.

17/17 Start guide

In this menu, we can decide whether the start guide will run again the next time the system is started.

Control - Menus

Menu 1 – INDOOR CLIMATE

OVERVIEW

Sub-menus

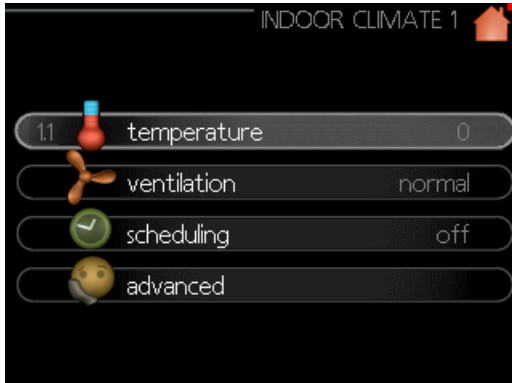

For the menu INDOOR CLIMATE there are several submenus. Status information for the relevant menu can be found on the display to the right of the menus.

temperature Setting the temperature for the climate system. The status information shows the set values for the climate system.

ventilation Setting the fan speed. The status information shows the selected setting. This menu is only displayed if the exhaust air module is connected (accessory).

scheduling Scheduling heating, cooling and ventilation. Status information "set" is displayed if you set a schedule but it is not active now, "holiday setting" is displayed if the vacation schedule is active at the same time as the schedule (the vacation function is prioritised), "active" displays if any part of the schedule is active, otherwise it displays "off".

advanced Setting of heat curve, adjusting with external contact, minimum value for supply temperature, room sensor and cooling function.

MENU 1.1 - TEMPERATURE

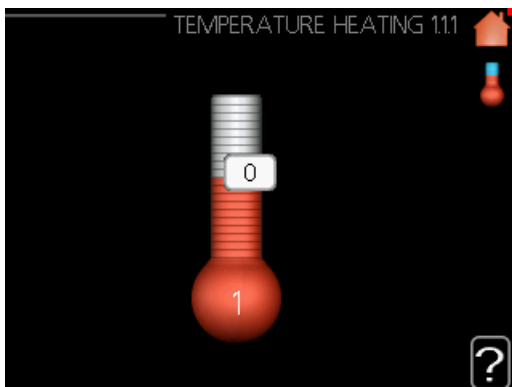

If the house has several climate systems, this is indicated on the display by a thermometer for each system.

Choose between heating or cooling and then set the desired temperature in the next menu "temperature heating/cooling" in menu 1.1.

Set the temperature (with room sensor installed and activated):

heating

Setting range: 5 – 30 °C
Factory setting: 20

cooling (cooling must be activated)

Setting range: 5 – 30 °C
Factory setting: 25

The value in the display appears as a temperature in °C if the climate system is controlled by a room sensor.



CAUTION!

- A slow heating system such as underfloor heating may not be suitable for control using the room sensors.

To change the room temperature, use the control knob to set the desired temperature in the display. Confirm the new setting by pressing the OK button. The new temperature is shown on the right-hand side of the symbol in the display.

Setting the temperature (without room sensors activated):

Setting range: -10 to +10
Factory setting: 0

The display shows the set values for heating (curve offset). To raise or lower the indoor temperature, increase or reduce the value on the display.

Use the control knob to set a new value. Confirm the new setting by pressing the OK button.

The number of steps the value has to be changed to achieve a degree change of the indoor temperature depends on the heating installation. One step is usually enough but in some cases several steps may be required.

Setting the desired value. The new value is shown on the right-hand side of the symbol in the display.

CAUTION!

- An increase in the room temperature can be slowed by the thermostats for the radiators or under floor heating. Therefore, open the thermostats fully, except in those rooms where a cooler temperature is required, e.g. bedrooms.

TIP!

Wait 24 hours before making a new setting, so that the room temperature has time to stabilise.

If it is cold outdoors and the room temperature is too low, increase the curve slope in menu 1.9.1.1 by one increment.

If it is cold outdoors and the room temperature is too high, lower the curve slope in menu 1.9.1.1 by one increment.

If it is warm outdoors and the room temperature is too low, increase the curve offset in menu 1.1.1 by one increment.

If it is warm outdoors and the room temperature is too high, lower the curve offset in menu 1.1.1 by one increment.

MENU 1.2 - VENTILATION (ACCESSORY REQUIRED)

Setting range: normal and speed 1-4
Factory setting: normal

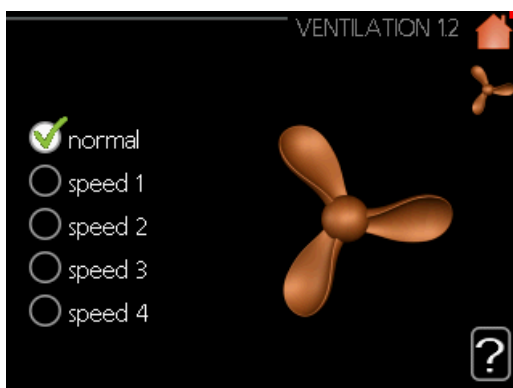

The ventilation in the accommodation can be temporarily increased or reduced here.

When you have selected a new speed a clock starts a count down. When the time has counted down the ventilation speed returns to the normal setting.

If necessary, the different return times can be changed in menu 1.9.6.

The fan speed is shown in brackets (in percent) after each speed alternative.

TIP!

If longer time changes are required use the holiday function or scheduling.

NOTE!

The ventilation accessory requires a minimum ventilation flow in order to work properly. An insufficient ventilation flow can result in an alarm and blocking of compressor operation.

MENU 1.3 - SCHEDULING

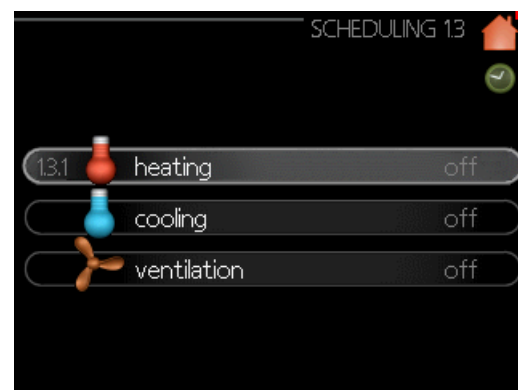

In the menu *scheduling* indoor climate (heating/cooling/ventilation) is scheduled for each weekday.

You can also schedule a longer time during a selected period (holiday) in menu 4.7.

MENU 1.3.1 - HEATING

Increases or decreases in the accommodation temperature can be scheduled here for up to three time periods per day. One step is usually enough to change the room temperature by one degree, but in some cases several steps may be required.

If a room sensor is installed and activated, the desired room temperature (°C) is set during the time periods.

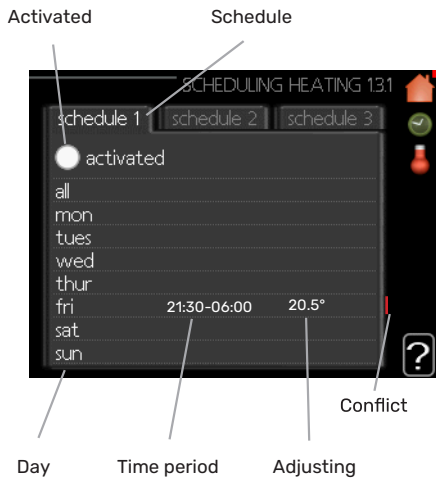

Schedule: The schedule to be changed is selected here.

Activated: Scheduling for the selected period is activated here. Set times are not affected at deactivation.

System: The climate system that the relevant schedule relates to is selected here. This alternative is only displayed if there is more than one climate system.

Day: Select which day or days of the week the scheduling is to apply to here. To remove the scheduling for a particular day, the time for that day must be reset by setting the start time to the same as the stop time. If the row "all" is used, all days in the period are set according to that row.

Time period: The start and stop time for the selected day for scheduling are selected here.

Adjustment: How much the heating curve is to be offset in relation to menu 1.1 during scheduling is set here. If a room sensor is installed, the desired room temperature is set in °C.

Conflict: If two settings conflict with each other, a red exclamation mark is displayed.



TIP!

If you wish to set similar scheduling for every day of the week start by filling in "all" and then changing the desired days.



TIP!

Set the stop time earlier than the start time so that the period extends beyond midnight. Scheduling then stops at the set stop time the day after. Scheduling always starts on the date that the start time is set for.



NOTE!

Changes of temperature in accommodation take time. For example, short time periods in combination with underfloor heating will not give a noticeable difference in room temperature.

MENU 1.3.2 - COOLING (COOLING MUST BE ACTIVATED)

Here you can schedule when cooling is permitted in the accommodation for up to two different time periods per day.



Schedule: The schedule to be changed is selected here.

Activated: Scheduling for the selected period is activated here. Set times are not affected at deactivation.

Day: Select which day or days of the week the scheduling is to apply to here. To remove the scheduling for a particular day, the time for that day must be reset by setting the start time to the same as the stop time. If the row "all" is used, all days in the period are set according to that row.

Time period: The start and stop time for the selected day for scheduling are selected here.

Adjustment: Here, you schedule when cooling will not be permitted.

Conflict: If two settings conflict with each other, a red exclamation mark is displayed.



TIP!

If you wish to set similar scheduling for every day of the week start by filling in "all" and then changing the desired days.



TIP!

Set the stop time earlier than the start time so that the period extends beyond midnight. Scheduling then stops at the set stop time the day after. Scheduling always starts on the date that the start time is set for.



TIP!

Set the stop time earlier than the start time so that the period extends beyond midnight. Scheduling then stops at the set stop time the day after. Scheduling always starts on the date that the start time is set for.

MENU 1.3.3 - VENTILATION (ACCESSORY REQUIRED)

Increases or decreases in the ventilation to the accommodation can be scheduled here for up to two time periods per day.

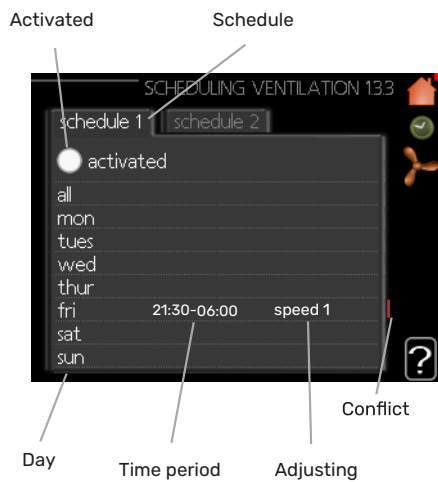

Schedule: The schedule to be changed is selected here.

Activated: Scheduling for the selected period is activated here. Set times are not affected at deactivation.

Day: Select which day or days of the week the scheduling is to apply to here. To remove the scheduling for a particular day, the time for that day must be reset by setting the start time to the same as the stop time. If the row "all" is used, all days in the period are set according to that row.

Time period: The start and stop time for the selected day for scheduling are selected here.

Adjustment: The desired fan speed is set here.

Conflict: If two settings conflict with each other, a red exclamation mark is displayed.



TIP!

If you wish to set similar scheduling for every day of the week start by filling in "all" and then changing the desired days.



NOTE!

A significant change over a longer period of time may cause poor indoor environment and worse operating economy.

MENU 1.9 - ADVANCED

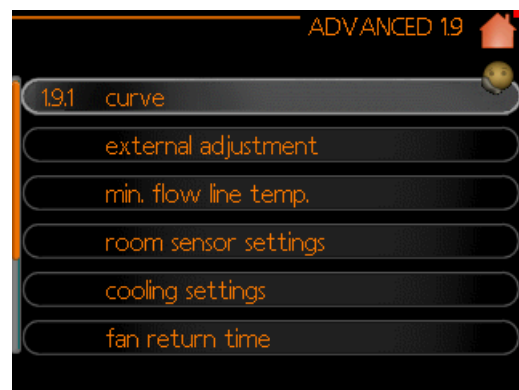

Menu advanced has orange text and is intended for the advanced user. This menu has several sub-menus.

curve Setting the curve slope for heating and cooling.

external adjustment Setting the heat curve offset when the external contact is connected.

min. flow line temp. Setting minimum permitted flow line temperature.

room sensor settings Settings regarding the room sensor.

cooling settings Settings for cooling.

fan return time Fan return time settings in the event of temporary ventilation speed change.

own curve Setting own curve for heating and cooling.

point offset Setting the offset of the heating curve or cooling curve at a specific outdoor temperature.

night cooling Setting night cooling.

MENU 1.9.1 - CURVE

heating curve

Setting range: 0 – 15

Factory setting: 7

cooling curve (cooling must be activated)

Setting range: 0 – 9

Factory setting: 0

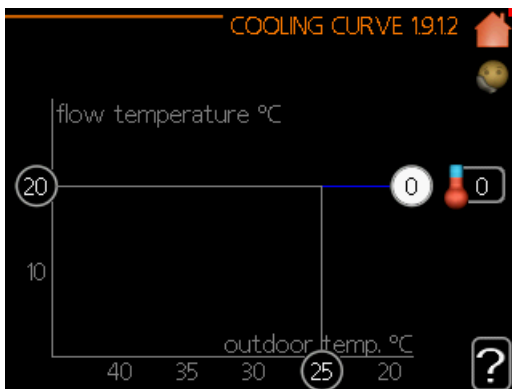
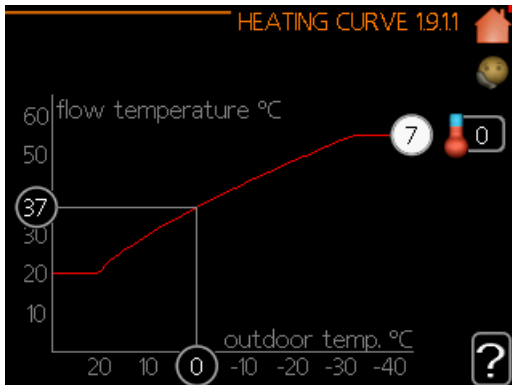

The prescribed heating curve for your house can be viewed in the menu **heating curve**. The task of the heating curve is to give an even indoor temperature, regardless of the outdoor temperature, and thereby energy efficient operation. It is from this heating curve that the control module's control computer determines the temperature of the water to the heating system, supply temperature, and therefore the indoor temperature. Select the heating curve and read off how the supply temperature changes at different outdoor temperatures here. If there is access to cooling the same settings can be made for the cooling curve.

NOTE!

With underfloor heating systems, **max flow line temperature** should normally be set to between 35 and 45 °C.

With underfloor cooling, "min. flow line temp." must be restricted to prevent condensation.

Check the max and min temperature for your floor with your installer/floor supplier.



TIP!

Wait 24 hours before making a new setting, so that the room temperature has time to stabilise.

If it is cold outdoors and the room temperature is too low, increase the curve slope in menu 1.9.1.1 by one increment.

If it is cold outdoors and the room temperature is too high, lower the curve slope in menu 1.9.1.1 by one increment.

If it is warm outdoors and the room temperature is too low, increase the curve offset in menu 1.9.1.1 by one increment.

If it is warm outdoors and the room temperature is too high, lower the curve offset in menu 1.9.1.1 by one increment.

MENU 1.9.2 - EXTERNAL ADJUSTMENT

Set the temperature (with room sensor installed and activated):

Setting range: 5 – 30 °C

Factory setting: 20

Setting the temperature (without room sensors activated):

Setting range: -10 to +10.

Factory setting: 0

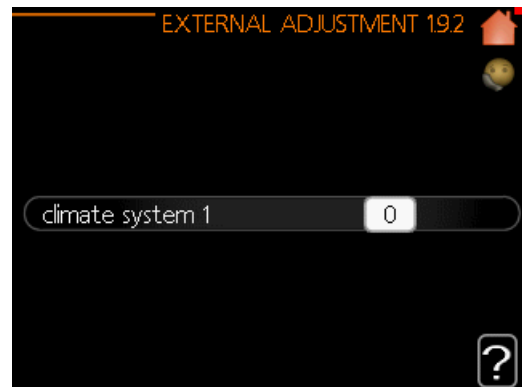

Connecting an external contact, for example, a room thermostat or a timer allows you to temporarily or periodically raise or lower the room temperature while heating. When the contact is on, the heating curve offset is changed by the number of steps selected in the menu. If a room sensor is installed and activated the desired room temperature (°C) is set.

If there is more than one climate system the setting can be made separately for each system.

MENU 1.9.3 - MIN. FLOW LINE TEMP.

heating

Setting range: 5-70 °C
Factory setting: 20 °C

cooling (cooling must be activated)

Depending on which cooling function (in 2-pipe system or 4-pipe system) is used, the lower limit of the setting range can vary from 7 to 18 °C.

Setting range: 7-30 °C
Factory setting: 18 °C

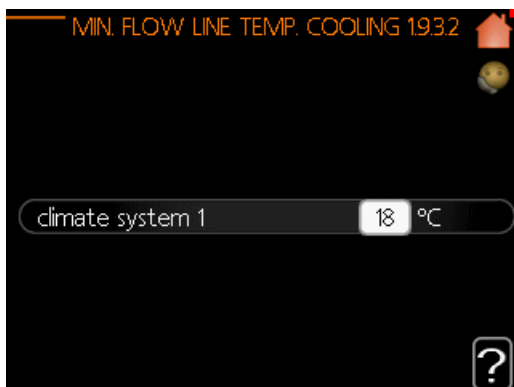
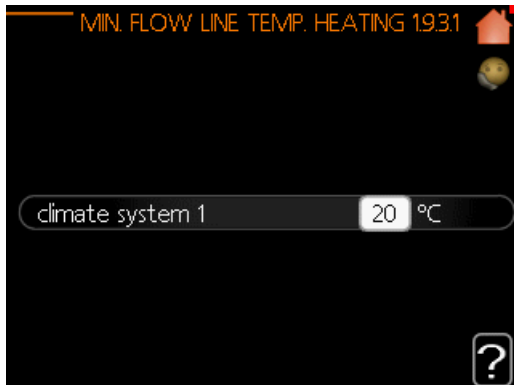

In menu 1.9.3 you select heating or cooling, in the next menu (min. supply temp.heating/cooling) set the minimum temperature on the supply temperature to the climate system.

If there is more than one climate system the setting can be made separately for each system.



TIP!

The value can be increased if you have, for example, a cellar that you always want to heat, even in summer.

You may also need to increase the value in "stop heating" menu 4.9.2 "auto mode setting".

MENU 1.9.4 - ROOM SENSOR SETTINGS

factor system

heating

Setting range: 0.0 - 6.0
Factory setting heating: 1.0

cooling (cooling must be activated)

Setting range: 0.0 - 6.0
Factory setting cooling: 1.0

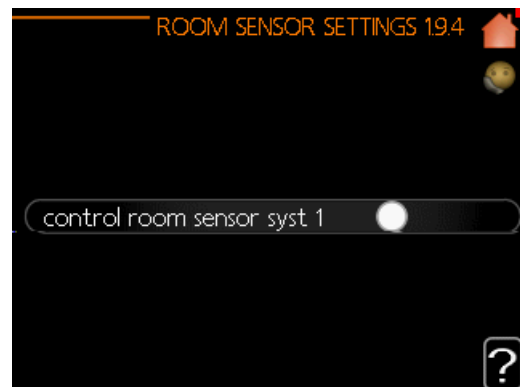

Room sensors to control the room temperature is not activated in factory settings and can be activated here.



NOTE!

A slow heating system such as underfloor heating may not be suitable for control using the installation's room sensors.

Here you can set a factor (a numerical value) that determines how much an over or sub normal temperature (the difference between the desired and actual room temperature) in the room is to affect the supply temperature to the climate system. A higher value gives a greater and faster change of the heating curve's set offset.



CAUTION!

- Too high a set value for „factor system“ can (depending on your climate system) produce an unstable room temperature

If several climate systems are installed the above settings can be made for the relevant systems.

MENU 1.9.5 - COOLING SETTINGS (cooling must be activated)

You can use SHK 20-200 to control the cooling in your house during hot periods of the year.



NOTE!

Certain setting options only appear if their function is installed and activated in SHK 20-200.

delta at +20 °C

Setting range: 3 – 10 °C
Factory setting: 3

delta at +40 °C

Setting range: 3 – 20 °C
Factory setting: 6

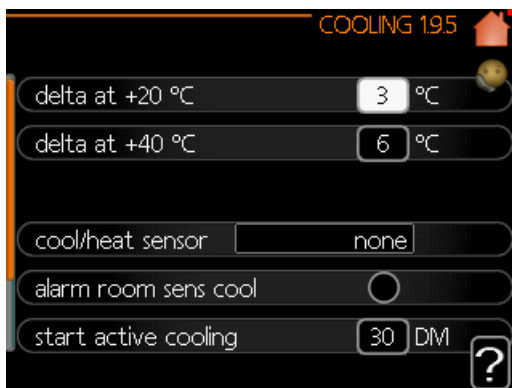

cool/heat sensor

Setting range: BT74 (BT50, RMU-BT50)
Factory setting: none

set pt value cool/heat sensor

Setting range: 5 – 40 °C
Factory setting: 21

heat at room under temp.

Setting range: 0.5 – 10.0 °C
Factory setting: 1.0

cool at room over temp.

Setting range: 0.5 – 10.0 °C
Factory setting: 3.0

start active cooling

Setting range: 10 – 300 DM
Factory setting: 30 DM

degree minutes cooling

Setting range: -3000 – 3000 cooling degree minutes
Factory setting: -1

time betw. switch heat/cool (Displayed if cooling in 2-pipe system is activated.)

Setting range: 0 – 48 h
Factory setting: 2

delta at +20 °C

Set the desired temperature on the temperature difference between supply and return lines to the climate system during cooling operation when the outdoor temperature is +20 °C. SHK 20-200 then attempts to get as close to the set temperature as possible.

delta at +40 °C

Set the desired temperature on the temperature difference between supply and return lines to the climate system during cooling operation when the outdoor temperature is +40 °C. SHK 20-200 then attempts to get as close to the set temperature as possible.

cool/heat sensor

An additional temperature sensor can be connected to the heat pump to determine when to switch between heating and cooling.

When several heating/cooling sensors are installed, you can select which one of them should be in control.



NOTE!

When the heating/cooling sensors (BT74) have been connected and activated in menu 5.4, no other sensor can be selected in menu 1.9.5.

set pt value cool/heat sensor

Here you can set at which indoor temperature SHK 20-200 is to shift between heating respectively cooling operation.

heat at room under temp.

Here you can set how far the room temperature can drop below the desired temperature before SHK 20-200 switches to heating operation.

cool at room over temp.

Here you can set how high the room temperature can increase above the desired temperature before SHK 20-200 switches to cooling operation.

alarm room sensor cooling

This is where you set whether SHK 20-200 is to initiate an alarm if the room sensor is disconnected or breaks during cooling operation.

start active cooling

Here you can set when active cooling is to start.

Degree minutes are a measurement of the current heating demand in the house and determine when the compressor, cooling operation respectively additional heat will start/stop.

degree minutes cooling

The menu has an information function, the SHK 20-200 unit cannot create cascade systems.

time betw. switch heat/cool

This selection is only available when cooling in 2-pipe systems. Here you can set how long controller is to wait before it returns to heating mode when the cooling demand has ceased or vice versa.



NOTE!

Do not set the value "0" in "time betw. switch heat/cool" as this may result in frequent switching of the operating mode.



NOTE!

This setting option only appears if cooling is activated in menu 5.11.1.1.

MENU 1.9.6 - FAN RETURN TIME (ACCESSORY REQUIRED)

speed 1-4

Setting range: 1 - 99 h

Factory setting: 4 h

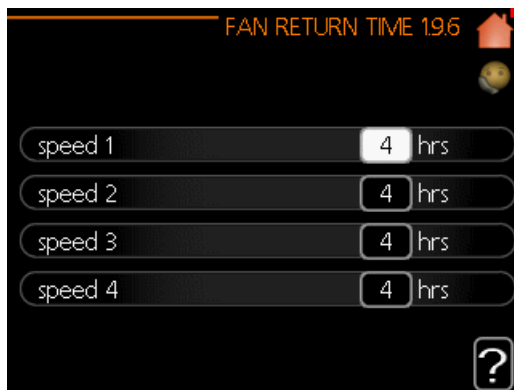

Here you select the return time for temporary speed change (speed 1-4) on the ventilation in menu 1.2.

Return time is the time it takes before ventilation speed returns to normal.

MENU 1.9.7 - OWN CURVE

supply temperature

heating

Setting range: 5 - 70 °C

cooling (cooling must be activated)

Depending on which accessory is used the setting range can vary.

Setting range: 7 - 40 °C

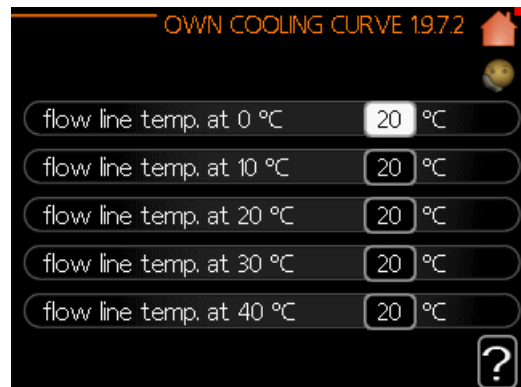
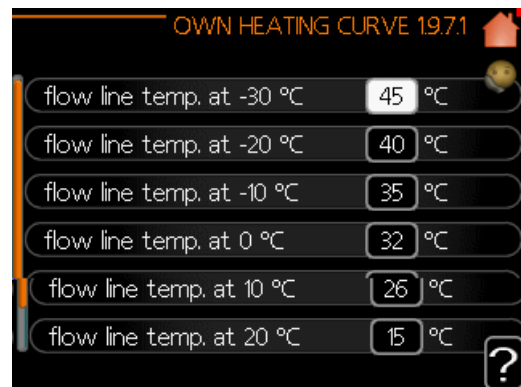

You can use SHK 20-200 to control the cooling in your house during hot periods of the year.



NOTE!

Curve 0 in menu 1.9.1 must be selected for own curve to apply.

MENU 1.9.8 - POINT OFFSET

outdoor temp. point

Setting range: -40 - 30 °C

Factory setting: 0 °C

change in curve

Setting range: -10 - 10 °C

Factory setting: 0 °C

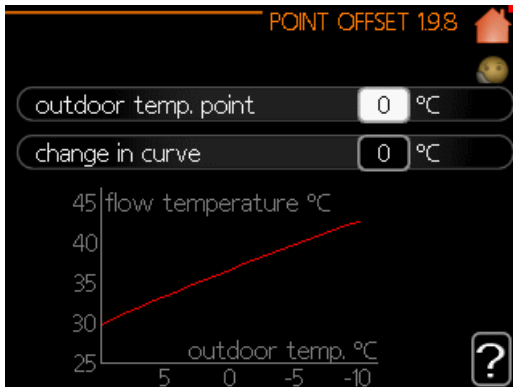

Select a change in the heating curve at a certain outdoor temperature here. One step is usually enough to change the room temperature by one degree, but in some cases several steps may be required.

The heat curve is affected at $\pm 5^\circ\text{C}$ from set outdoor temp. point.

It is important that the correct heating curve is selected so that the room temperature is experienced as even.



TIP!

If it is cold in the house, at, for example -2°C , "outdoor temp. point" is set to -2 and "change in curve" is increased until the desired room temperature is maintained.



NOTE!

Wait 24 hours before making a new setting, so that the room temperature has time to stabilise.

MENU 1.9.9 - NIGHT COOLING (ACCESSORY REQUIRED)

start temp. exhaust air

Setting range: $20 - 30^\circ\text{C}$

Factory setting: 25°C

min diff. outdoor-exhaust

Setting range: $3 - 10^\circ\text{C}$

Factory setting: 6°C

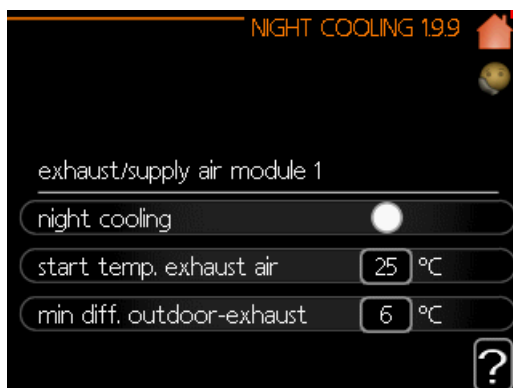

Activate night cooling here.

When the temperature in the house is high and the outdoor temperature is lower, a cooling effect can be obtained by forcing the ventilation.

If the temperature difference between the exhaust air and the outdoor temperature is greater than the set value („min diff. outdoor-exhaust“), and the exhaust air temperature is higher than the set value („start temp. exhaust air“), run the ventilation at speed 4 until one of the conditions is no longer met.



NOTE!

Night cooling can only be activated when house heating has been deactivated. This is done in menu 4.2.

Menu 2 – HOT WATER

OVERVIEW

Sub-menus



For the menu HOT WATER there are several sub-menus. Status information for the relevant menu can be found on the display to the right of the menus.

temporary lux Activation of temporary increase in the hot water temperature. Status information displays “off” or what length of time of the temporary temperature increase remains.

comfort mode Setting hot water comfort. The status information displays what mode is selected, “economy”, “normal” or “luxury”.

scheduling Scheduling hot water comfort. The status information “set” appears if you have set scheduling but it is not currently active, “holiday setting” appears if holiday setting is active at the same time as scheduling (when the holiday function is prioritised), “active” appears if any part of scheduling is active, otherwise “off” appears.

advanced Setting periodic increase in the hot water temperature.

MENU 2.1 - TEMPORARY LUX

Setting range: 3, 6 and 12 hours and mode “off” and “one time increase”

Factory setting: “off”

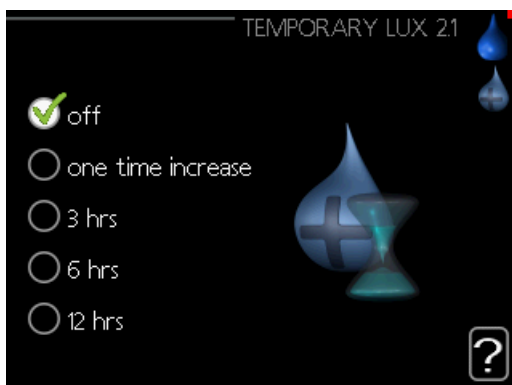

When hot water requirement has temporarily increased this menu can be used to select an increase in the hot water temperature to lux mode for a selectable time.



NOTE!

If comfort mode “luxury” is selected in menu 2.2 no further increase can be carried out.

The function is activated immediately when a time period is selected and confirmed using the OK button. The remaining time for the selected setting is shown to the right.

When the time has run out SHK 20-200 returns to the mode set in menu 2.2.

Select “off” to switch off **temporary lux** .

MENU 2.2 - COMFORT MODE

Setting range: smart control, economy, normal, luxury

Factory setting: normal

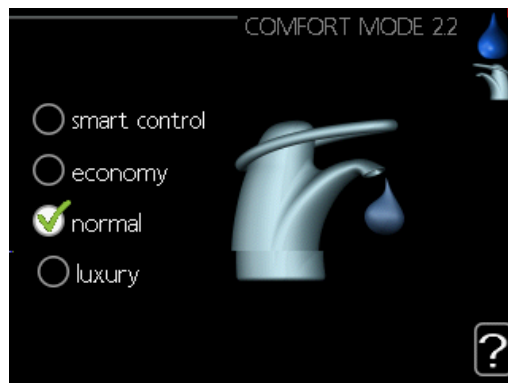

The difference between the selectable modes is the temperature of the hot tap water. Higher temperature means that the hot water lasts longer.

smart control: In this menu you activate the Smart Control function. The function learns the previous week’s hot water consumption and adapts the temperature in the water heater for the coming week to ensure minimal energy consumption.

If the hot water demand is greater, there is a certain additional amount of hot water available.

When the Smart Control function is activated, the water heater delivers the reported performance according to the energy decal.

economy: This mode produces less hot water than the others, but is more economical. This mode can be used in smaller households with a small hot water requirement.

normal: Normal mode gives a larger amount of hot water and is suitable for most households.

luxury: Lux mode gives the greatest possible amount of hot water. In this mode, the immersion heater is used to heat hot water as well as the compressor, which increases operating costs.

MENU 2.3 - SCHEDULING

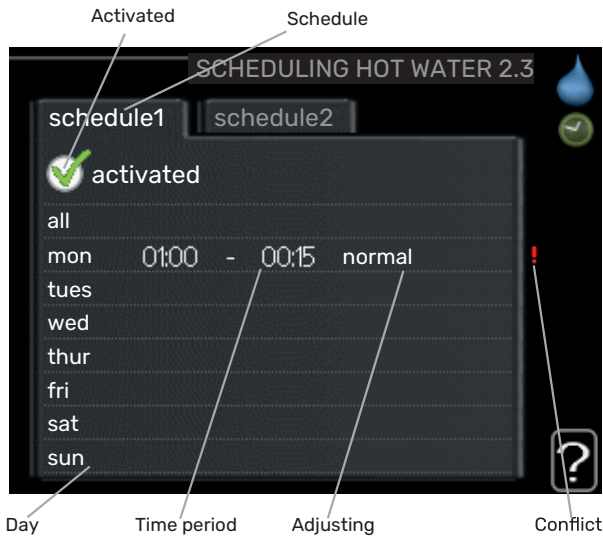

Two different periods of hot water comfort per day can be scheduled here.

Scheduling is activated/deactivated by ticking/unticking "activated". Set times are not affected at deactivation.

Schedule: The schedule to be changed is selected here.

Activated: Scheduling for the selected period is activated here. Set times are not affected at deactivation.

Day: Select which day or days of the week the scheduling is to apply to here. To remove the scheduling for a particular day, the time for that day must be reset by setting the start time to the same as the stop time. If the row "all" is used, all days in the period are set according to that row.

Time period: The start and stop time for the selected day for scheduling are selected here.

Adjustment: Set the hot water comfort that is to apply during scheduling here.

Conflict: If two settings conflict with each other, a red exclamation mark is displayed.



TIP!

If you wish to set similar scheduling for every day of the week start by filling in "all" and then changing the desired days.



TIP!

Set the stop time earlier than the start time so that the period extends beyond midnight. Scheduling then stops at the set stop time the day after.

Scheduling always starts on the date that the start time is set for.

MENU 2.9 - ADVANCED

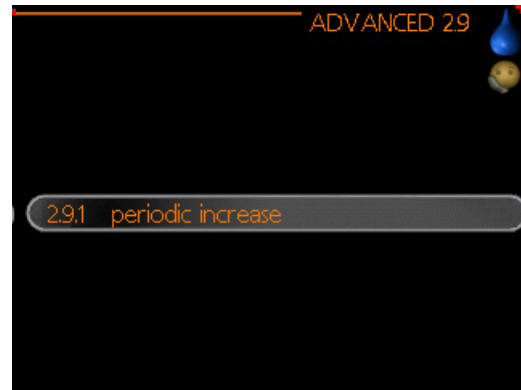

Menu **advanced** has orange text and is intended for the advanced user. This menu has several sub-menus.

MENU 2.9.1 - PERIODIC INCREASE

period

Setting range: 1 - 90 days
Factory setting: 7 days

start time

Setting range: 00:00 - 23:00
Factory setting: 00:00

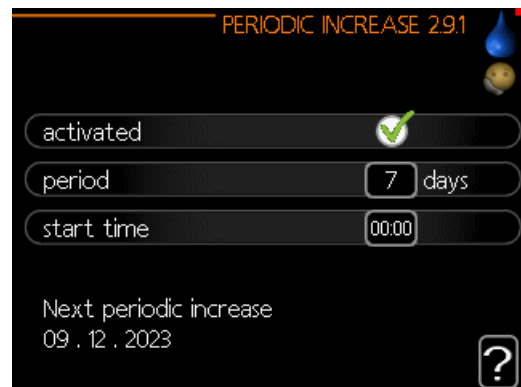

To prevent bacterial growth in the water heater, the compressor and the immersion heater can increase the hot water temperature for a short time at regular intervals.

The length of time between increases can be selected here. The time can be set between 1 and 90 days. Factory setting is 7 days. Tick/untick "activated" to start/switch off the function.

MENU 2.9.2 - HOT WATER RECIRC.

operating time

Setting range: 1 - 60 min
Factory setting: 60 min

downtime

Setting range: 0 - 60 min
Factory setting: 0 min

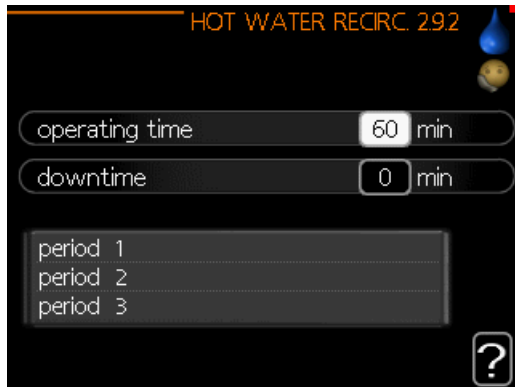

Set the hot water circulation for up to three periods per day here. During the set periods the hot water circulation pump will run according to the settings above.

“operating time” decide how long the hot water circulation pump must run per operating instance.

“downtime” decide how long the hot water circulation pump must be stationary between operating instances.

Hot water circulation is activated in menu 5.4 “soft inputs and outputs”.

Menu 3 – INFO

OVERVIEW

Sub-menus



For the menu INFO there are several sub-menus. No settings can be made in these menus, they just display information. Status information for the relevant menu can be found on the display to the right of the menus.

service info shows temperature levels and settings in the installation.

compressor info shows operating times, number of starts etc for the compressor in the heat pump.

add. heat info displays information about the additional heat's operating times etc.

alarm log shows the latest alarms.

indoor temp. log the average temperature indoors week by week during the past year.

MENU 3.1 - SERVICE INFO

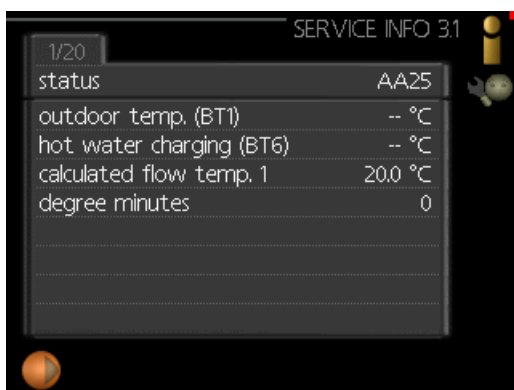

Information about the actual operating status of the installation (e.g. current temperatures etc.) can be obtained here. No changes can be made. The information is on several pages. Turn the control knob to scroll between the pages.

A QR code appears on one side. This QR code indicates serial number, product name and limited operating data.

Symbols in this menu:			
	Compressor		Heating
	Addition		Hot water
	Cooling		Pool
	Heating medium pump (orange)		Ventilation
	Additional heat in tank		
	Solar accessory		

MENU 3.2 - COMPRESSOR INFO

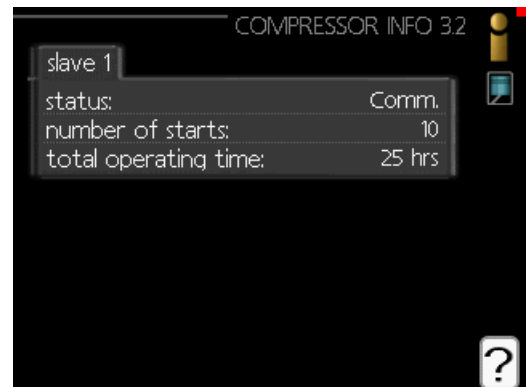

Information about the compressor's operating status and statistics can be obtained here. No changes can be made. The information is on several pages. Turn the control knob to scroll between the pages.

MENU 3.3 - ADD. HEAT INFO

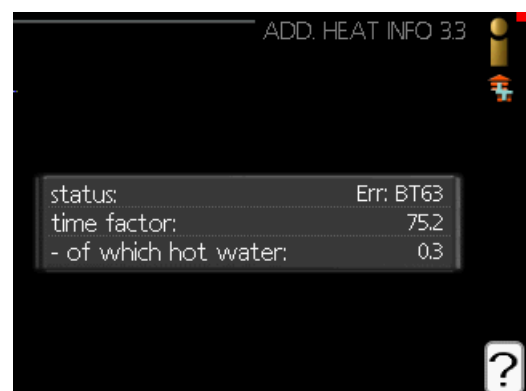

Information about the additional heat's settings, operating status and statistics can be obtained here. No changes can be made. The information is on several pages. Turn the control knob to scroll between the pages.

MENU 3.4 - ALARM LOG

Date	Time	Description
25.11.2023	14:24	Com.ft acc
25.11.2023	14:24	Com.ft acc
25.11.2023	14:24	Com.ft acc
25.11.2023	14:23	Comm.
25.11.2023	14:23	Flt:AZ30-BT21
25.11.2023	14:23	AZ30-BT20
25.11.2023	14:23	Flt:AZ30-BT23
25.11.2023	14:23	Flt:AZ30-BT22
25.11.2023	14:23	Err: BT63
25.11.2023	14:23	Err: EQ1-BT64

To facilitate troubleshooting, the installation’s operating status at alarm alerts is stored here. You can see information for the 10 most recent alarms.

To view the run status in the event of an alarm, mark the alarm and press the OK button.

Parameter	Value
Com. flt accessory (297)	
outdoor temp. (BT1)	-- °C
hot water charging (BT6)	-- °C
outdoor temp. (BT28)	-53.0 °C
condenser return (BT3)	-- °C
condenser out (BT12)	-- °C
addition (BT63)	-- °C
evaporator (BT16)	-63.0 °C
operating time	0 min
op. mode	off

Information about an alarm.

MENU 3.5 - INDOOR TEMP. LOG

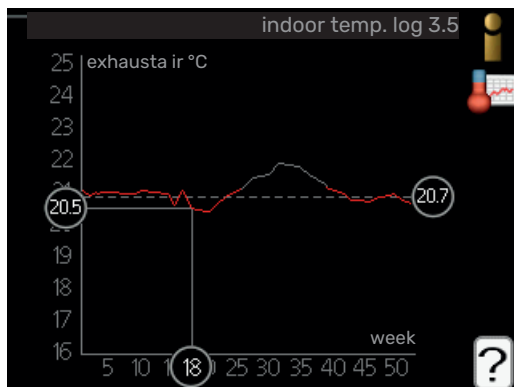

Here you can see the average temperature indoors week by week during the past year. The dotted line indicates the annual average temperature.

The average outdoor temperature is only shown if a room temperature sensor/room unit is installed.

To read off an average temperature

1. Turn the control knob so that the ring on the shaft with the week number is marked.
2. Press the OK button.
3. Follow the grey line up to the graph and out to the left to read off the average indoor temperature at the selected week.
4. You can now select to take read outs for different weeks by turning the control knob to the right or left and read off the average temperature.
5. Press the OK or Back button to exit read off mode.

Menu 4 – MY SYSTEM

OVERVIEW

Sub-menus

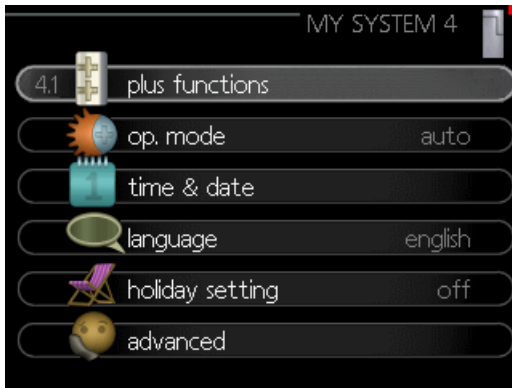

For the menu MY SYSTEM there are several sub-menus. Status information for the relevant menu can be found on the display to the right of the menus.

plus functions Settings applying to any installed extra functions in the heating system.

op. mode Activation of manual or automatic operating mode. The status information shows the selected operating mode.

time & date Setting current time and date.

language Select the language for the display here. The status information shows the selected language.

holiday setting Vacation scheduling heating, hot water and ventilation. Status information "set" is displayed if you set a vacation schedule but it is not active at the moment, "active" is displayed if any part of the vacation schedule is active, otherwise it displays " off".

advanced Settings of control module work mode.

MENU 4.1 - PLUS FUNCTIONS

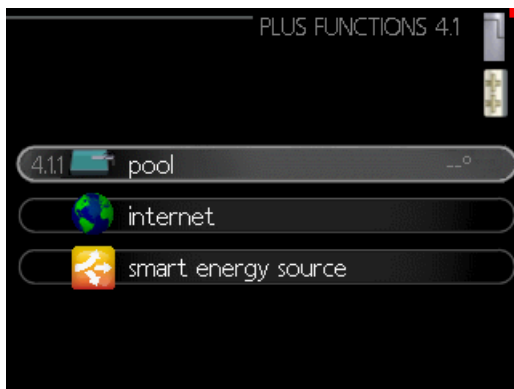

Settings for any additional functions installed in SHK 20-200 can be made in the sub menu.

MENU 4.1.1 - POOL 1 (ACCESSORY IS REQUIRED)

start temp

Setting range: 5.0 - 80.0 °C
Default value: 22.0 °C

stop temperature

Setting range: 5.0 - 80.0 °C
Default value: 24.0 °C

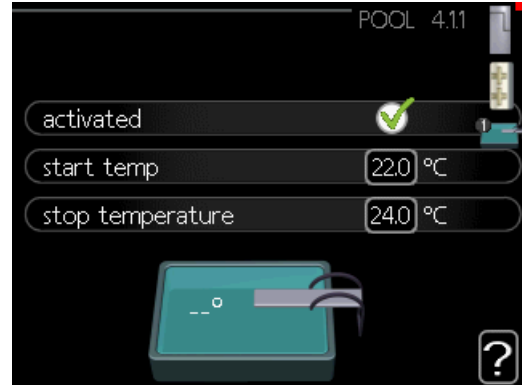

Select whether the pool control is to be activated, within what temperatures (start and stop temperature) pool heating must occur and how many compressors may work against the pool at the same time.

When the pool temperature drops below the set start temperature and there is no hot water or heating requirement, SHK 20-200 starts pool heating.

Untick "activated" to switch off the pool heating.



NOTE!

The start temperature cannot be set to a value that is higher than the stop temperature.

MENU 4.1.3 - INTERNET

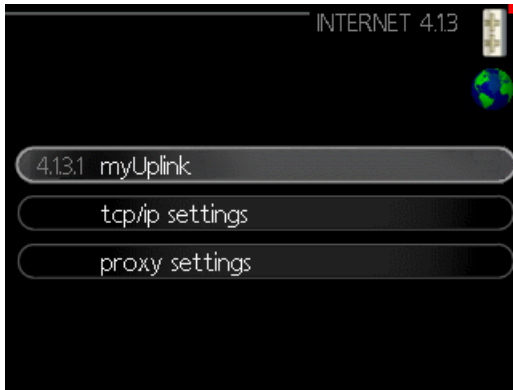

Here you make the settings for connecting SHK 20-200 via my- Uplink, which uses the Internet.

- CAUTION!**
- For these functions to work the network cable must be connected.

MENU 4.1.3.1 - MYUPLINK

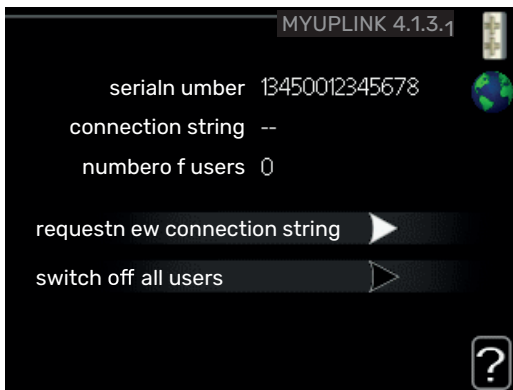

Here you can manage the installation's connection to my-Uplink (myuplink.com) and see the number of users connected to the installation via the internet.

A connected user has a user account in myUplink , which has been given permission to control and/or monitor your installation.

Request new connection string

To connect a user account on myUplink to your installation, you must request a unique connection code.

- Mark "request new connection string" and press the OK button.
- The installation now communicates with myUplink to create a connection code.
- When a connection string has been received, it is shown in this menu at "connection string" and is valid for 60 minutes.

Disconnect all users

- Mark "switch off all users" and press the OK button.
- The installation now communicates with myUplink to release your installation from all users connected via the internet.

- CAUTION!**
- After disconnecting all users none of them can monitor or control your installation via myUplink without requesting a new connection string.

MENU 4.1.3.8 - TCP/IP SETTINGS



Here, you can set TCP/IP settings for your installation.

Automatic setting (DHCP)

- Tick "automatic". The installation now receives the TCP/IP settings using DHCP.
- Mark "confirm" and press the OK button.

Manual setting

- Untick "automatic", you now have access to several setting options.
- Mark "ip-address" and press the OK button.
- Enter the correct details via the virtual keypad.
- Select "OK" and press the OK button.
- Repeat 1 - 3 for "net mask", "gateway" and "dns".
- Mark "confirm" and press the OK button.

- NOTE!**
- The installation cannot connect to the internet without the correct TCP/IP settings. If unsure about applicable settings use the automatic mode or contact your network administrator (or similar) for further information.

- TIP!**
- All settings made since opening the menu can be reset by marking "reset" and pressing the OK button.

MENU 4.1.3.9 - PROXY SETTINGS

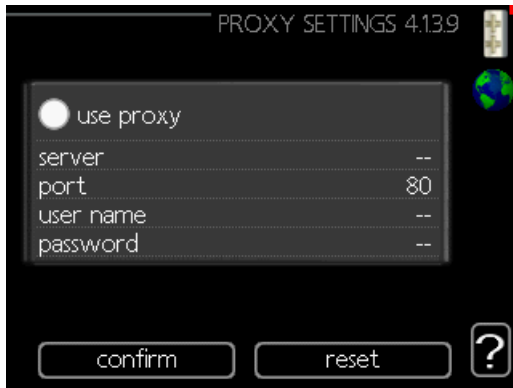

You can set proxy settings for your installation here.

Proxy settings are used to give connection information to a intermediate server (proxy server) between the installation and Internet. These settings are primarily used when the installation connects to the Internet via a company network.

The installation supports proxy authentication of the HTTP Basic and HTTP Digest type.

If unsure about applicable settings, contact your network administrator (or equivalent) for further information.

Setting

1. Tick "use proxy" if you do not want to use a proxy.
2. Mark "server" and press the OK button.
3. Enter the correct details via the virtual keypad.
4. Select "OK" and press the OK button.
5. Repeat 1 - 3 for "port", "user name" and "password".
6. Mark "confirm" and press the OK button.



TIP!

All settings made since opening the menu can be reset by marking "reset" and pressing the OK button.

MENU 4.1.5 - SG READY



This function can only be used in mains networks that support the "SG Ready"-standard.

Make settings for the function "SG Ready" here.

affect room temperature

Here you set whether room temperature should be affected when activating "SG Ready".

With low price mode on "SG Ready" the parallel offset for the indoor temperature is increased by "+1". If a room sensor is installed and activated, the desired room temperature is instead increased by 1 °C.

With over capacity mode on "SG Ready" the parallel offset for the indoor temperature is increased by "+2". If a room sensor is installed and activated, the desired room temperature is instead increased by 2 °C.

affect hot water

Here you set whether the temperature of the hot water should be affected when activating "SG Ready".

With low price mode on "SG Ready", the stop temperature for the hot water is set as high as possible with compressor operation only (immersion heater not permitted).

With over capacity mode of "SG Ready" the hot water is set to "luxury" (immersion heater permitted).

affect cooling (accessory required)

Here you set whether room temperature during cooling operation should be affected when activating "SG Ready".

With low price mode of "SG Ready" and cooling operation the indoor temperature is not affected.

With over capacity mode on "SG Ready" and cooling operation, the parallel offset for the indoor temperature is reduced by "-1". If a room sensor is installed and activated, the desired room temperature is instead reduced by 1 °C.

affect pool temperature (accessory is required)

Here you set whether pool temperature should be affected when activating "SG Ready".

With low price mode on "SG Ready", the desired pool temperature (start and stop temperature) is increased by 1 °C.

With over capacity mode on "SG Ready" the desired pool temperature (start and stop temperature) is increased by 2 °C



CAUTION!

The function must be connected and activated in your SHK 20-200.

MENU 4.1.6 - SMART PRICE ADAPTION™

affect room temperature

Setting range: 1 - 10

Factory setting: 5

affect hot water

Setting range: 1 - 4

Factory setting: 2

affect pool temperature

Setting range: 1 - 10

Factory setting: 2

affect cooling

Setting range: 1 - 10

Factory setting: 3

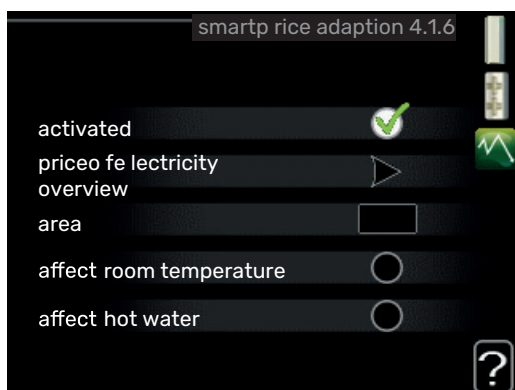

area

In this menu you state where the heat pump is located and how great a role the electricity price should play. The greater the value, the greater the effect the electricity price has and the possible savings are larger, but at the same time there is an increased risk of affecting comfort.

price of electricity overview

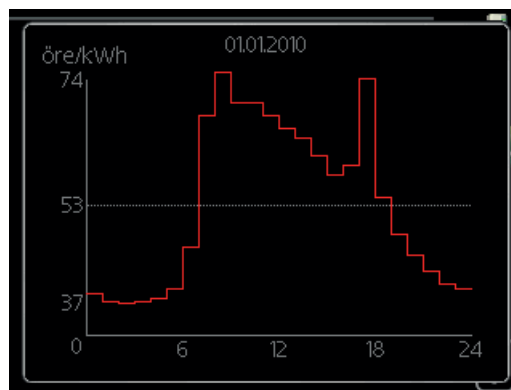

Here you can obtain information on how the electricity price varies over up to three days.

Smart price adaption™ moves the heat pump's consumption over 24 hours to periods with the cheapest electricity tariff, which gives savings for hourly rate based electricity contracts. The function is based on hourly rates for the next 24 hours being retrieved via myUplink and therefore an internet connection and an account for myUplink are required.

Deselect "activated" to switch off Smart price adaption™.

MENU 4.1.7 - SMART HOME (ACCESSORY IS REQUIRED)

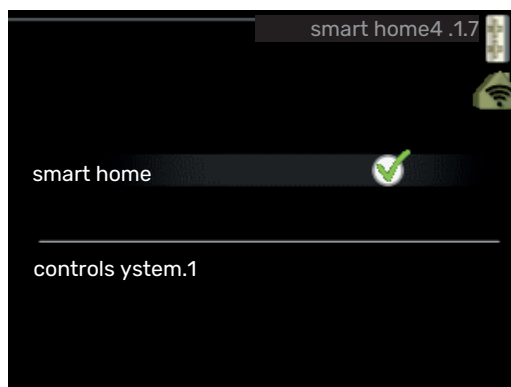

When you have a smart home system that can speak to myUplink, by activating the smart home function in this menu you can control the SHK 20-200 via an app.

By allowing connected units to communicate with myUplink, your heating system becomes a natural part of your homesmart home and gives you the opportunity to optimise the operation.



NOTE!

The smart home function requires myUplink in order to work.

MENU 4.1.8 - SMART ENERGY SOURCE™

settings
set. price
CO2 impact*
tariff periods, electricity
tariff per, ext. shunt add
tariff per, ext. step add

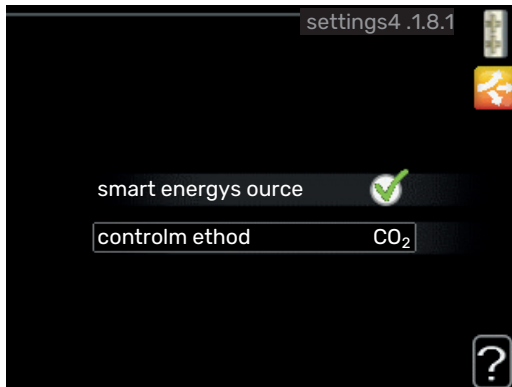
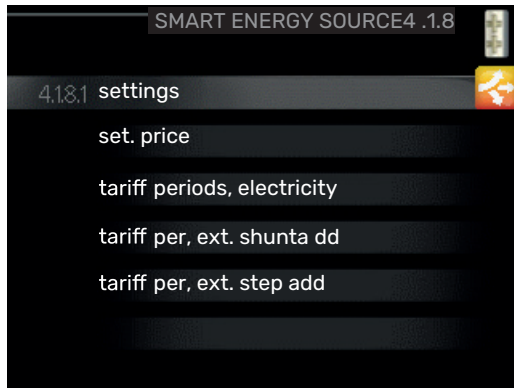

The function prioritises how / to what extent each docked energy source will be used. Here you can choose if the system is to use the energy source that is cheapest at the time.

You can also choose if the system is to use the energy source that is most carbon neutral at the time.

*Select control method "CO₂" under settings to open this menu.

MENU 4.1.8.1 - SETTINGS

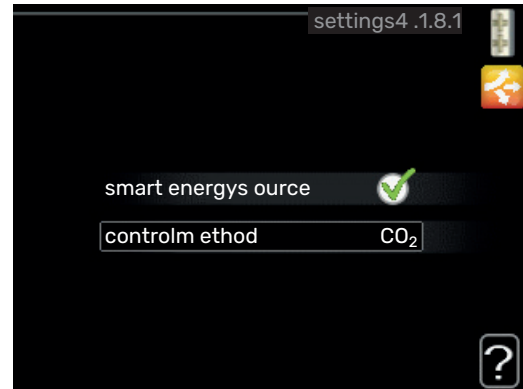

smart energy source™

Setting range: Off/On
Factory setting: Off

control method

Setting range: Price / CO₂
Factory setting: Price

MENU 4.1.8.2 - SET. PRICE

price, electricity

Setting range: spot, tariff, fixed price
Factory setting: fixed price
Setting range fixed price: 0-100,000*

price, extern shunt add.

Setting range: tariff, fixed price
Factory setting: fixed price
Setting range fixed price: 0-100,000*

price, extern step add.

Setting range: tariff, fixed price
Factory setting: fixed price
Setting range fixed price: 0-100,000*



Here you can choose whether the system is to exercise control based on the spot price, tariff control or a set price. The setting is made for each individual energy source. Spot price can only be used if you have an hourly tariff agreement with your electricity supplier.

*The currency varies depending on the country selected.

MENU 4.1.8.3 - CO2 IMPACT

CO2, electricity

Setting range: 0-5
Factory setting: 2.5

CO2, ext. shunted contr. add.

Setting range: 0-5
Factory setting: 1

CO2, ext. step contr. add.

Setting range: 0-5
Factory setting: 1

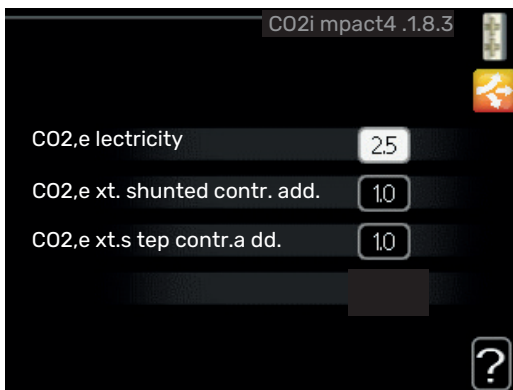

Here, you set the size of the carbon footprint for each energy source.

The carbon footprint is different for different energy sources. For example, the energy from solar cells and wind turbines can be considered carbon dioxide neutral and, therefore, has a low CO₂ impact. Energy from fossil fuels can be considered to have a higher carbon footprint and, therefore, has a higher CO₂ impact.

MENU 4.1.8.4 - TARIFF PERIODS, ELECTRICITY



Here you can use tariff control for the electric additional heat.

Set the lower tariff periods. It is possible to set two different date periods per year. Within these periods, it is possible to set up to four different periods on weekdays (Monday to Friday) or four different periods on weekends (Saturdays and Sundays).

MENU 4.1.8.6 - TARIFF PER, EXT. SHUNT ADD



Here you can use tariff control for the external shunted additional heat.

Set the lower tariff periods. It is possible to set two different date periods per year. Within these periods, it is possible to set up to four different periods on weekdays (Monday to Friday) or four different periods on weekends (Saturdays and Sundays).

MENU 4.1.8.7 - TARIFF PER, EXT. STEP ADD



Here you can use tariff control for the external step controlled additional heat.

Set the lower tariff periods. It is possible to set two different date periods per year. Within these periods, it is possible to set up to four different periods on weekdays (Monday to Friday) or four different periods on weekends (Saturdays and Sundays).

MENU 4.1.10 - SOLAR ELECTRICITY (ACCESSORY REQUIRED)

affect room temperature

Setting range: on/off
Factory setting: off

affect hot water

Setting range: on/off
Factory setting: off

affect pool temperature¹

Setting range: on/off
Factory setting: off

3-phase

Setting range: on/off
Factory setting: off

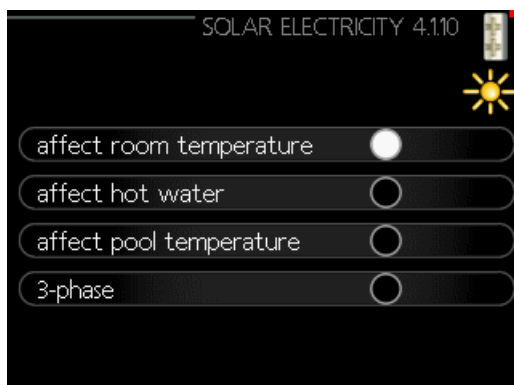

This is where you set which part of your installation (room temperature, hot water temperature, pool temperature) is to benefit from the solar electricity surplus.

When the solar panels produce more electricity than SHK 20-200 requires, the temperature in the property is adjusted and/or the temperature of the hot water is increased.

EME

In this menu you can also make settings that are specific for your EME.

For EME 20, you can select whether you want domestic electricity to be prioritised ahead of room temperature and hot water, provided that an external energy meter is connected to SHK 20-200.

MENU 4.2 - OP. MODE

op. mode

Setting range: auto, manual, add. heat only
Factory setting: auto

functions

Setting range: compressor, addition, heating, cooling

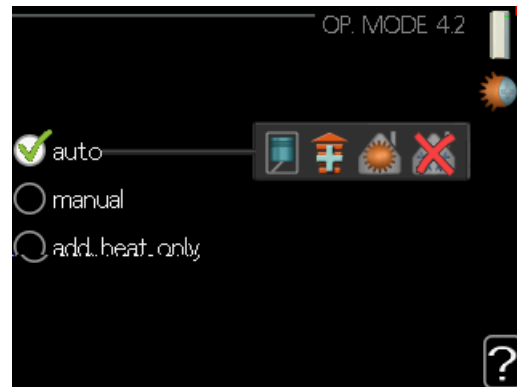

The control module operating mode is usually set to "auto". It is also possible to set the control module to "add. heat only", when only additional heat is used, or "manual" and then select what functions are to be permitted.

Change the operating mode by marking the desired mode and pressing the OK button. When an operating mode is selected it shows what in the control module is permitted (crossed out = not permitted) and selectable alternatives to the right. To select selectable functions that are permitted or not, mark the function using the control knob and press the OK button.

Operating mode auto

In this operating mode the control module automatically selects what functions are permitted.

Operating mode manual

In this operating mode you can select what functions are permitted. You cannot deselect "compressor" in manual mode.

Operating mode add. heat only

In this operating mode the compressor is not active, only additional heat is used.

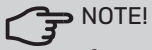
**NOTE!**

If you choose mode "add. heat only" the compressor is deselected and there is a higher operating cost.

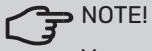
**NOTE!**

You cannot change from add. heat only if you do not have a heat pump connected.

Functions

"*compressor*" is the unit that produces heating and hot water for the home. If "compressor" is deselected in auto mode, this is displayed with a symbol in the main menu. You cannot deselect "compressor" in manual mode.

"*addition*" is the unit that helps the compressor to heat the home and/or the hot water when it cannot manage the entire requirement alone.

"*heating*" means you obtain heating in the home. You can deselect the function when you do not wish to have the heating on.

"*cooling*" means that you obtain cooling in the home in hot weather. This alternative requires an accessory for cooling, or for the air/water heat pump to have a built-in function for cooling, and is activated in the menu. You can deselect this function when you do not wish to have cooling in operation.

MENU 4.4 - TIME & DATE

Set time and date, display mode and time zone here.

MENU 4.6 - LANGUAGE

Choose the language that you want the information to be displayed in here.

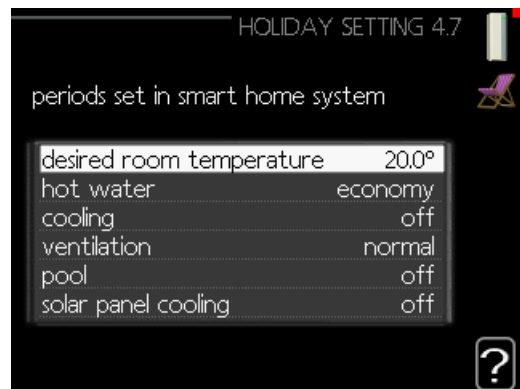
MENU 4.7 - HOLIDAY SETTING

To reduce energy consumption during a holiday you can schedule a reduction in heating and hot water temperature. Cooling, ventilation, pool and solar panel cooling can also be scheduled if the functions are connected.

If a room sensor is installed and activated, the desired room temperature (°C) is set during the time period. This setting applies to all climate systems with room sensors.

If a room sensor is not activated, the desired offset of the heating curve is set. One step is usually enough to change the room temperature by one degree, but in some cases several steps may be required. This setting applies to all climate systems without room sensors.

The vacation scheduling starts at 00:00 on the start date and stops at 23:59 on the stop date.

**TIP!**

Stop the holiday setting about a day before your return so that room temperature and hot water have time to return to their usual levels.

**TIP!**

Set the vacation setting in advance and activate just before departure in order to maintain the comfort.

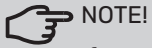

NOTE!

If you choose to stop hot water production for a holiday, "periodic increase" (preventing bacterial growth) will be blocked during this time. "periodic heat increase" will start up in conjunction with the vacation setting ending.

MENU 4.9 - ADVANCED

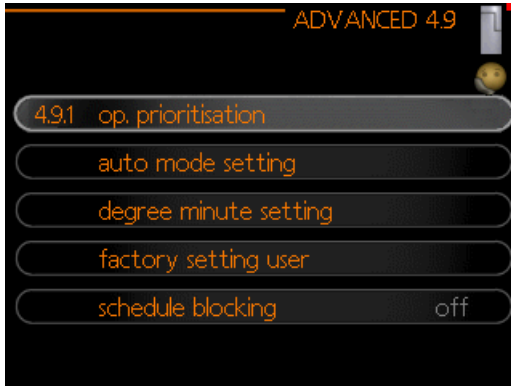

Menu **advanced** has orange text and is intended for the advanced user. This menu has several sub-menus.

MENU 4.9.1 - OP. PRIORITISATION

op. prioritisation

Setting range: 0 to 180 min

Factory setting: 30 min

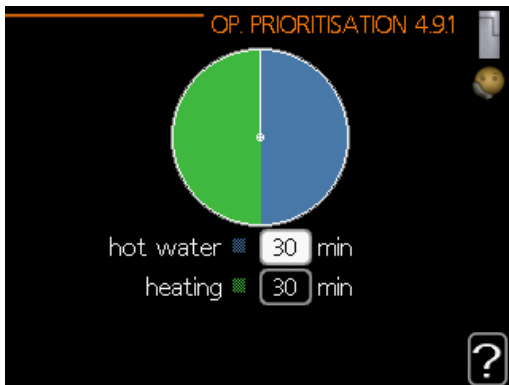

Choose here how long the heat pump should work with each requirement if there are two or more requirements at the same time. If there is only one requirement the heat pump only works with that requirement.

The indicator marks where in the cycle the heat pump is. If 0 minutes is selected, this means that the requirement is not prioritised, but will only be activated when there is no other requirement.

MENU 4.9.2 - AUTO MODE SETTING

start cooling (cooling must be activated)

Setting range: 15 – 40 °C

Factory setting: 25

stop heating

Setting range: 5 – 40 °C

Factory setting: 17

stop additional heat

Setting range: -25 – 40 °C

Factory setting: 5

filtering time

Setting range: 0 – 48 h

Factory setting: 24 h

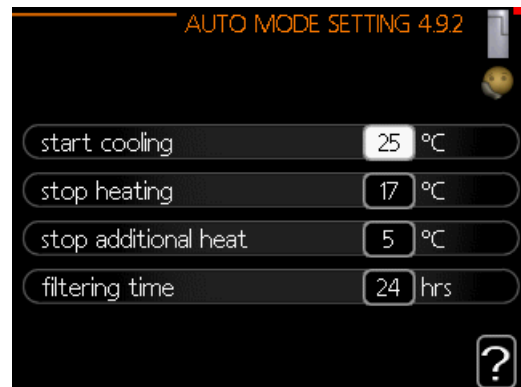

When the operating mode is set to "auto", the control module selects when start and stop of additional heat and heat production is permitted, depending on the average outdoor temperature. If the heat pump has the integrated cooling function and it is activated in the menu you can also select the start temperature for cooling.

Select the average outdoor temperatures in this menu.



NOTE!

It cannot be set "stop additional heat" higher than "stop heating".



NOTE!

In systems where heating and cooling share the same pipes (2-pipe cooling), „stop heating" cannot be set higher than „start cooling" if there is no cooling/heating sensor.

filtering time: You can also set the time (filtering time) over which the average temperature is calculated. If you select 0, the current outdoor temperature is used.

MENU 4.9.3 - DEGREE MINUTE SETTING

current value
Setting range: -459 – 100

start compressor
Setting range: -1000 – -30
Factory setting: -60

start diff additional heat
Setting range: 100 – 2000
Factory setting: 400

diff. between additional steps
Setting range: 10 – 1000
Factory setting: 30

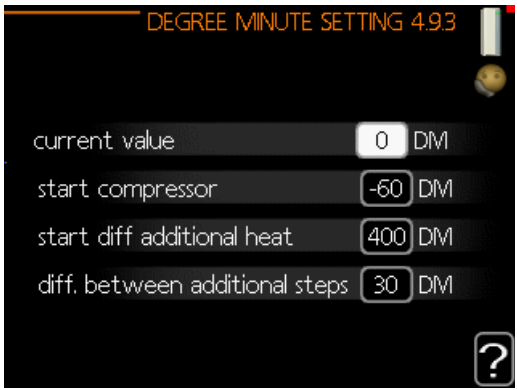

Degree minutes are a measurement of the current heating requirement in the house and determine when the compressor respectively additional heat will start/stop.

NOTE!
Higher value on "start compressor" gives more compressor starts, which increase wear on the compressor. Too low value can give uneven indoor temperatures.

NOTE!
The compressor curves can only be edited by qualified personnel.

MENU 4.9.4 - FACTORY SETTING USER

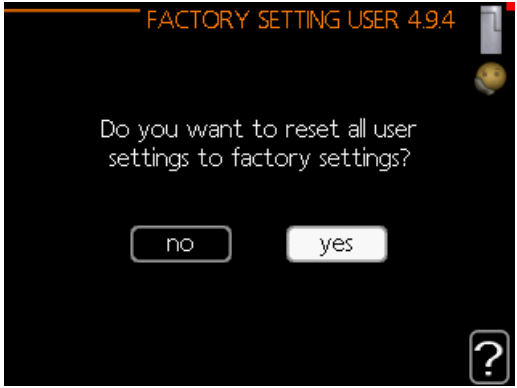

All settings that are available to the user (including advanced menus) can be reset to default values here.

NOTE!
After restoring the factory settings, you must re-set individual parameters, such as the heating curve.

MENU 4.9.5 - SCHEDULE BLOCKING

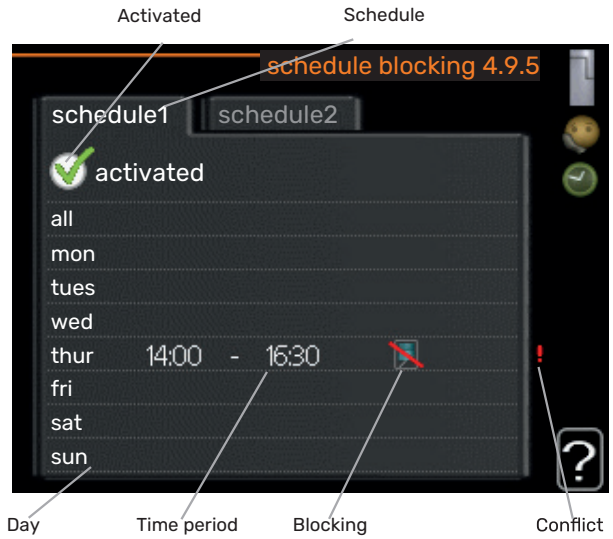

The additional heat or compressor can be scheduled to be blocked for up to two different time periods here.

When scheduling is active the relevant blocking symbol is shown in the main menu on the symbol for the control module.

- Schedule:** The period to be changed is selected here.
- Activated:** Scheduling for the selected period is activated here. Set times are not affected at deactivation.
- Day:** Select which day or days of the week the scheduling is to apply to here. To remove the scheduling for a particular day, the time for that day must be reset by setting the start time to the same as the stop time. If the row "all" is used, all days in the period are set according to that row.
- Time period:** The start and stop time for the selected day for scheduling are selected here.
- Blocking:** The desired blocking is selected here.
- Conflict:** If two settings conflict with each other, a red exclamation mark is displayed.

- Blocking the compressor in the outdoor module.
- Blocking additional heat.

TIP!
If you wish to set similar scheduling for every day of the week start by filling in "all" and then changing the desired days.



TIP!

Set the stop time earlier than the start time so that the period extends beyond midnight. Scheduling then stops at the set stop time the day after. Scheduling always starts on the date that the start time is set for.



NOTE!

Long term blocking can cause reduced comfort and operating economy.



NOTE!

After factory setting, personal settings such as heating curves must be reset.

Cooling settings

In the factory settings of the SHK 20-200 the cooling is deactivated and requires activation in menu 5.11.1.1 in order to start it up.

Factory setting:

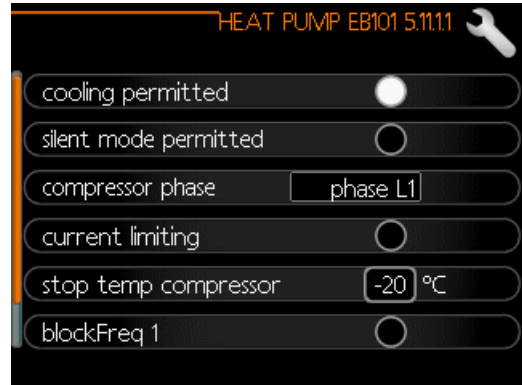

CAUTION!

By default, cooling works in the 2-pipe system. In order to change the cooling mode to 4-pipe, it must be activated in menu 5.2.4.

To start up cooling, change the "start cooling" parameter in menu 4.9.2 to the higher value (applies to the outside temperature) which starts cooling in accordance with the settings in menu 1.9 (settings are in menu 1.9.1.2, 1.9.3.2 and 1.9.5).

Factory setting:

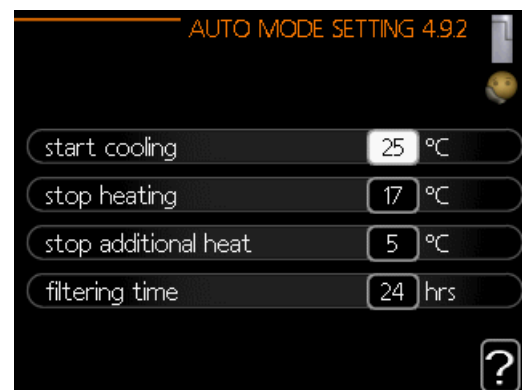

If the average temperature calculated by the "filtering time" is higher than the one set, cooling will start in accordance with the settings in menu 1.9 (settings are in menu 1.9.1.2, 1.9.3.2 and 1.9.5).



CAUTION!

The settings for cooling should be made based on the existing CH system. The above cooling settings can only be edited by qualified personnel.

Menu 5 - SERVICE

OVERVIEW

5 - SERVICE	5.1 - operating settings	5.1.1 - hot water settings
		5.1.2 - max flow line temperature
		5.1.3 - max diff flow line temp.
		5.1.4 - alarm actions
		5.1.5 - fan sp. exhaust air*
		5.1.6 - fan sp. supply air*
		5.1.12 - internal electrical addition
		5.1.14 - flow set. climate system
		5.1.22 - heat pump testing
		5.1.23 - compressor curve
		5.1.25 - time filter alarm
	5.2 - system settings	5.2.2 - installed slaves
		5.2.4 - accessories
	5.3 - accessory settings	5.3.2 - shunt controlled add. heat
		5.3.3 - extra climate system*
		5.3.4 - solar heating*
		5.3.6 - step controlled add. heat
		5.3.8 - hot water comfort*
		5.3.11 - modbus*
		5.3.12 - exhaust/supply air module*
		5.3.14 - F135*
		5.3.16 - humidity sensor*
		5.3.21- flow sensor / energy meter*
	5.4 - soft in/outputs	
	5.5 - factory setting service	
	5.6 - forced control	
	5.7 - start guide	
	5.8 - quick start	
	5.9 - floor drying function	
	5.10 - change log	
	5.11 - slave settings	5.11.1 - EB101
		5.11.1.1 - heat pump
		5.11.1.2 - charge pump (GP12)
	5.12 - country	

The above menu diagram may vary depending on the installed accessories.

* Accessory needed.

Go to the main menu and hold the Back button in for 7 seconds to access the Service menu.

Sub-menus

Menu SERVICE has orange text and is intended for the advanced user. This menu has several sub-menus. Status information for the relevant menu can be found on the display to the right of the menus.

operating settings Operating settings for the control

system settings System settings for the control module, activating accessories etc.

accessory settings Operational settings for different accessories.

soft in/outputs Setting software-controlled in and outputs on the input board (AA3) and terminal block (X2).

factory setting service Total reset of all settings (including settings available to the user) to default values.

forced control Forced control of the different components in the indoor module.

start guide Manual start of the start guide which is run the first time when the control module is started.

quick start Quick starting the compressor.



CAUTION!

- Incorrect settings in the service menus can damage the installation and heat pump.

MENU 5.1 - OPERATING SETTINGS

Operating settings can be made for the control module in the sub menus.

MENU 5.1.1 - HOT WATER SETTINGS



CAUTION!

- The factory set tap water temperatures specified in the manual can vary due to the directives in force in different countries. From this menu, you can check the relevant settings for the system.

economy

Setting range start temp. economy: 5 – 45 °C
Factory setting start temp. economy: 39 °C
Setting range stop temp. economy: 5 – 45 °C
Factory setting stop temp. economy: 43 °C

normal

Setting range start temp. normal: 5 – 50 °C
Factory setting start temp. normal: 42 °C
Setting range stop temp. normal: 5 – 50 °C
Factory setting stop temp. normal: 46 °C

luxury

Setting range start temp. lux: 5 – 60 °C
Factory setting start temp. lux: 45 °C
Setting range stop temp. lux: 5 – 60 °C
Factory setting stop temp. lux: 49 °C

stop temp. per. increase

Setting range: 55 – 60 °C
Factory setting: 60 °C

step difference compressors

Setting range: 0.5 – 4.0 °C
Factory setting: 1.0 °C

charge method

Setting range: target temp, delta temp
Factory setting: delta temp

Here you set the start and stop temperature of the hot water for the different comfort options in menu 2.2 as well as the stop temperature for periodic increase in menu 2.9.1.

The charge method for hot water operation is selected here. "delta temp" is recommended for heaters with charge coil, "target temp" for double-jacketed heaters and heaters with hot water coil.

MENU 5.1.2 - MAX FLOW LINE TEMPERATURE

climate system

Setting range: 5-70 °C
Factory setting: 55 °C

Here, you set the maximum supply temperature for the climate system. If the installation has more than one climate system, individual maximum supply temperatures can be set for each system. Climate system 2 - 8 cannot be set to a higher max supply temperature than climate system 1.



NOTE!

For underfloor heating systems, max flow line temperature should normally be set to between 35 and 45°C.

Check the max and min temperature for your floor with your installer/floor supplier.

MENU 5.1.3 - MAX DIFF FLOW LINE TEMP.

max diff compressor

Setting range: 1 – 25 °C
Factory setting: 10 °C

max diff addition

Setting range: 1 – 24 °C
Factory setting: 7 °C

Here you set the maximum permitted difference between the calculated and actual/ current supply temperature in the event of compressor or additional heat mode respectively. Max diff. additional heat can never exceed max diff. compressor.

max diff compressor

If the current supply temperature exceeds the calculated supply by set value, the degree minute value is set to +2. The compressor in the heat pump stops if there is only a heating demand.

max diff addition

If "addition" is activated in menu 4.2 and the current supply temperature exceeds the calculated temperature by the set value, the additional heat is forced to stop.

MENU 5.1.4 - ALARM ACTIONS

Select how you want the control module to alert you that there is an alarm in the display here. The different alternatives are; the heat pump stops producing hot water and/or reduces the room temperature.



NOTE!

If no alarm action is selected, it can result in higher energy consumption in the event of an alarm.

MENU 5.1.5 - FAN SP. EXHAUST AIR (ACCESSORY IS REQUIRED)

normal and speed 1-4
Setting range: 0 - 100 %

Set the speed for the five different selectable speeds for the fan here.



NOTE!

An incorrectly set ventilation flow can damage the house and may also increase energy consumption.

MENU 5.1.6 - FAN SP. SUPPLY AIR (ACCESSORY REQUIRED)

normal and speed 1-4
Setting range: 0 - 100 %

Set the speed for the five different selectable speeds for the fan here.



NOTE!

An incorrectly set value may damage the house in the long term and possibly increase energy consumption.

MENU 5.1.12 - INTERNAL ELECTRICAL ADDITION

The settings in this menu apply to the method of controlling the auxiliary heater.



CAUTION!

The factory settings introduced in menu 5.1.12 are the required settings. Editing these settings is only possible by authorized installers and service technicians!

3x400V incoming power

Setting range: on/off
Factory setting: on

set max electrical add.

Setting range (230V): 0,0 - 4,5 kW
Setting range (400V): 0,0 - 9,0 kW
Factory setting: 9,0 kW

Fuse size

Setting range: 1 - 200A
Factory setting: 20A

transformation ratio

Setting range: 300 - 3000
Factory setting: 300

detect phase order (displayed if 3x400 V incoming power is activated.)



NOTE!

If the 3x400 V incoming power is active and current sensors are connected, the pdetect phase order function must be activated.



NOTE!

Setting the fuse too small may limit the power of the peak source and/or compressor.

MENU 5.1.14 - FLOW SET. CLIMATE SYSTEM

presettings

Setting range: radiator, floor heat., rad. + floor heat., DOT °C
Factory setting: radiator
Setting range DOT: -40.0 - 20.0 °C

The factory setting of DOT value depends on the country that has been given for the product's location. The example below refers to Poland.

Factory setting DOT: -15.0 °C

own setting

Setting range dT at DOT: 0.0 - 25.0
Factory setting dT at DOT: 10.0
Setting range DOT: -40.0 - 20.0 °C
Factory setting DOT: -20.0 °C

The type of heating distribution system the heating medium pump works towards is set here.

dT at DOT is the difference in degrees between flow and return temperatures at dimensioned outdoor temperature.

MENU 5.1.22 - HEAT PUMP TESTING



CAUTION!

This menu is intended for testing SHK 20-200 according to different standards. Use of this menu for other reasons may result in your installation not functioning as intended.

This menu contains several sub-menus, one for each standard.

MENU 5.1.23 - COMPRESSOR CURVE



NOTE!

This menu is only displayed if SHK 20-200 is connected to a heat pump with inverter controlled compressor.



NOTE!

The compressor curves can only be edited by qualified personnel.

Set whether the compressor in the heat pump should work to a particular curve under specific requirements or if it should work to predefined curves.

You set a curve for a demand (heat, hot water etc.) by un-ticking "auto", turning the control knob until a temperature is marked and pressing OK. You can now set at what temperatures the max. and min. frequencies, respectively will occur.

This menu can consist of several windows (one for each available demand), use the navigation arrows in the top left corner to change between the windows.

MENU 5.1.25 - TIME FILTER ALARM (ACCESSORY IS REQUIRED)

months btwn filter alarms

Setting range: 1 - 24

Factory setting: 3

Here you set the number of months between alarms for a reminder to clean the filter in a connected accessory.

MENU 5.2 - SYSTEM SETTINGS

Make different system settings for your installation here, e.g. activate connected slaves and which accessories are installed.

MENU 5.2.2 - INSTALLED SLAVES

One device can be selected.

search installed slaves

Mark "search installed slaves" and press the OK button to automatically find connected slaves for the master heat pump.

MENU 5.2.4 - ACCESSORIES

Set which accessories are installed on the installation here. There are two ways of activating connected accessories. You can either mark the alternative in the list or use the automatic function "search installed acc.".

search installed acc.

Mark "search installed acc." and press the OK button to automatically find connected accessories for SHK 20-200.

ACTIVATING 4 - PIPE COOLING OPERATION

In order to activate 4-pipe cooling, select the function "active cooling 4 pipe".

To enable cooling, see „Cooling Settings“.

MENU 5.3 - ACCESSORY SETTINGS

The operating settings for accessories that are installed and activated are made in the sub-menus for this.

MENU 5.3.2 - SHUNT CONTROLLED ADD. HEAT (ACCESSORY IS REQUIRED)

prioritised additional heat

Setting range: on/off
Factory setting: off

start diff additional heat

Setting range: 0 – 2000 DM
Factory setting: 400 DM

minimum running time

Setting range: 0 – 48 h
Factory setting: 12 h

min temp.

Setting range: 5 – 90 °C
Factory setting: 55 °C

mixing valve amplifier

Setting range: 0.1 – 10.0
Factory setting: 1.0

mixing valve step delay

Setting range: 10 – 300 s
Factory setting: 30 s

Set when the addition is to start, the minimum run time and the minimum temperature for external addition with shunt here. External addition with shunt is for example a wood / oil / gas / pellet boiler.

You can set shunt valve amplification and shunt valve waiting time.

Selecting “prioritised additional heat” uses the heat from the external additional heat instead of the heat pump. The shunt valve is regulated as long as heat is available, otherwise the shunt valve is closed.



TIP!

See the accessory installation instructions for function description.

MENU 5.3.3 - EXTRA CLIMATE SYSTEM (ACCESSORY IS REQUIRED)

use in heating mode

Setting range: on/off
Factory setting: on

use in cooling mode

Setting range: on/off
Factory setting: off

mixing valve amplifier

Setting range: 0.1 – 10.0
Factory setting: 1.0

mixing valve step delay

Setting range: 10 – 300 s
Factory setting: 30 s

Contr. pump GP10

Setting range: on/off
Factory setting: off

Here, you select which climate system (2 - 8) you wish to set.

use in heating mode: If the heat pump is connected to a climate system(s) for cooling, any condensation can take place in this/these. Check that “use in heating mode” has been selected for the climate system(s) that is/are not adapted for cooling. This setting means that the sub-shunt for the extra climate system closes when cooling operation is activated.

use in cooling mode: Select “use in cooling mode” for climate systems that are adapted to handle cooling. For 2-pipe cooling you can select both “use in cooling mode” and “use in heating mode”, while for 4-pipe cooling you can only select one option.



NOTE!

This setting option only appears if the heat pump is activated for cooling operation.

mixing valve amplifier, mixing valve step delay: Here, you set the shunt amplification and shunt waiting time for the various extra climate systems that are installed.

Contr. pump GP10: Here, you can set the speed of the circulation pump manually.

See the accessory installation instructions for function description.

MENU 5.3.4 - SOLAR HEATING (ACCESSORY IS REQUIRED)

start delta-T GP4

Setting range: 1 – 40 °C

Factory setting: 8 °C

stop delta-T GP4

Setting range: 0 – 40 °C

Factory setting: 4 °C

max. tank temperature

Setting range: 5 – 110 °C

Factory setting: 95 °C

max. solar collector temp.

Setting range: 80 – 200 °C

Factory setting: 125 °C

anti-freeze temperature

Setting range: -20 – +20 °C

Factory setting: 2 °C

start solar collector cooling

Setting range: 80 – 200 °C

Factory setting: 110 °C

start delta-T, stop delta-T: Here, you can set the temperature difference between solar panel and solar tank at which the circulation pump will start and stop.

max. tank temperature, max. solar collector temp.: Here, you can set the maximum temperatures in the tank and solar panel respectively at which the circulation pump will stop. This is to protect against excess temperatures in the solar tank.

If the unit has an anti-freeze function and/or solar panel cooling you can activate them here. When the function has been activated, you can make settings for them.

freeze protection

anti-freeze temperature: Here, you can set the temperature in the solar panel at which the circulation pump is to start to prevent freezing.

solar panel cooling

start solar collector cooling: If the temperature in the solar panel is higher than this setting, at the same time as the temperature in the solar tank is higher than the set maximum temperature, the external function for cooling is activated.

See the accessory installation instructions for function description.

MENU 5.3.6 - STEP CONTROLLED ADD. HEAT (ACCESSORY IS REQUIRED)

start diff additional heat

Setting range: 0 – 2000 DM

Factory setting: 400 DM

diff. between additional steps

Setting range: 0 – 1000 DM

Factory setting: 30 DM

max step

Setting range

(binary stepping deactivated): 0 – 3

Setting range

(binary stepping activated): 0 – 7

Factory setting: 3

binary stepping

Setting range: on/off

Factory setting: off

Make settings for step controlled addition here. Step controlled addition is for example an external electric boiler.

It is possible, for example, to select when the additional heat is to start, to set the maximum number of permitted steps and whether binary stepping is to be used.

When binary stepping is deactivated (off), the settings refer to linear stepping.

See the accessory installation instructions for function description.

MENU 5.3.8 - HOT WATER COMFORT (ACCESSORY IS REQUIRED)

activating immersion heater

Setting range: on/off

Factory setting: off

activ. imm. heat in heat mode (if activating immersion heater is on)

Setting range: on/off

Factory setting: on

activating the mixing valve

Setting range: on/off

Factory setting: off

outgoing hot water

Setting range: 40 – 65 °C

Factory setting: 55 °C

mixing valve amplifier

Setting range: 0.1 – 10.0

Factory setting: 1.0

mixing valve step delay

Setting range: 10 – 300 s

Factory setting: 30 s

Make settings for the hot water comfort here. See the accessory installation instructions for function description.

activating the mixing valve: Activated if mixer valve is installed and it is to be controlled from SHK 20-200. When the option is active, you can set the outgoing hot water temperature, shunt amplification and shunt waiting time for the mixer valve.

outgoing hot water: Here, you can set the temperature at which the mixer valve is to restrict hot water from the water heater.

MENU 5.3.11 - MODBUS (ACCESSORY IS REQUIRED)

address

Factory setting: address 1

word swap

Factory setting: not activated

As from Modbus 40 version 10, the address can be set between 1 - 247. Earlier versions have a fixed address (address 1).

Here, you can select if you want to have "word swap" instead of the preset standard "big endian".

See the accessory installation instructions for function description.

MENU 5.3.12 - EXHAUST/SUPPLY AIR MODULE (ACCESSORY IS REQUIRED)

months btwn filter alarms

Setting range: 1 - 24
Factory setting: 3

lowest extract air temp.

Setting range: 0 - 10 °C
Factory setting: 3 °C

bypass at excess temperature

Setting range: 2 - 10 °C
Factory setting: 4 °C

bypass during heating

Setting range: on/off
Factory setting: off

cut-out val. exh. air temp.

Setting range: 5 - 30 °C
Factory setting: 25 °C

product

Setting range: ERS S10, ERS 20/ERS 30
Factory setting: ERS 20 / ERS 30

action level monitor

Setting range: off, blocked, level monitor
Factory setting: level monitor

months btwn filter alarms: Set how often the filter alarm is to be displayed.

lowest extract air temp.: Set the minimum extract air temperature to prevent the build-up of ice on the heat exchanger. The supply air fan speed reduces, if the extract air temperature is lower than the set value.

bypass at excess temperature: If a room sensor is installed, you set the over-temperature at which the bypass damper will open here.

bypass during heating: Activate whether the bypass damper will also be allowed to open during heat production.

cut-out val. exh. air temp.: If no room sensor is installed, you set the exhaust air temperature at which the bypass damper will open here.

product: Here, you set which ERS model is installed.

action level monitor: If "level monitor" is selected, the product issues an alert and the fans stop when the input closes. If "blocked" is selected, text in operating info shows that the input is closed. The fans stop until the input is open.



TIP!

See the installation instructions for ERS and HTS for a function description.

MENU 5.3.14 - F135 (ACCESSORY IS REQUIRED)

charge pump speed

Setting range: 1 - 100 %
Factory setting: 70 %

hot water at cooling

Setting range: on/off
Factory setting: off

Here you can set the charge pump speed for F135. You can also choose whether you want to be able to charge hot water with F135 at the same time as the outdoor module produces cooling.



NOTE!

It is necessary for "active cooling 4 pipe" to be selected in either "accessories" or "soft in/outputs" to enable activation of "hot water during cooling". The heat pump must also be activated for cooling operation.

MENU 5.3.16 - HUMIDITY SENSOR (ACCESSORY IS REQUIRED)

climate system 1 HTS

Setting range: 1-4

Factory setting: 1

Heating

limit RH in the room, syst.

Setting range: on/off

Factory setting: off

Coling (cooling must be activated)

prevent condensation, syst.

Setting range: on/off

Factory setting: off

limit RH in the room, syst.

Setting range: on/off

Factory setting: off

Up to four humidity sensors (HTS 40) can be installed.

Here you select whether your system(s) is/are to limit the relative humidity level (RH) during heating or cooling operation.

You can also choose to limit min. cooling supply and calculated cooling supply to prevent condensation on pipes and components in the cooling system.

See the Installer Manual for HTS 40 for function description.

MENU 5.3.21 - FLOW SENSOR / ENERGY METER (ACCESSORY IS REQUIRED)

Flow sensor

set mode

Setting range: EMK150 / EMK300/310 / EMK500

Factory setting: EMK300/310

energy per pulse

Setting range: 0 – 10000 Wh

Factory setting: 1000 Wh

pulses per kWh

Setting range: 1 – 10000

Factory setting: 500

Energy meter

set mode

Setting range: energy per pulse / pulses per kWh

Default value: energy per pulse

energy per pulse

Setting range: 0 – 10000 Wh

Factory setting: 1000 Wh

pulses per kWh

Setting range: 1 – 10000

Factory setting: 500

Flow sensor (EMK) / energy meter can be connected on the input board AA3, terminal block X22 and X23. Select these in menu 5.2.4 - accessories.

Flow sensor (Energy measurement kit EMK)

A flow sensor (EMK) is used to measure the amount of energy produced and supplied by the heating installation for hot water and heating in the building.

The function of the flow sensor is to measure flow and temperature differences in the charge circuit. The value is presented in the display on a compatible product.

energy per pulse: Here you set the amount of energy to which each pulse will correspond.

pulses per kWh: Here you set the number of pulses per kWh that are sent to controller.



NOTE!

Visit myuplink.com and click on the "Software" tab to download the latest software to your installation.

Energy meter (Electricity meter)

The energy meter(s) is used to send pulse signals every time a certain amount of energy has been consumed.

energy per pulse: Here you set the amount of energy to which each pulse will correspond.

pulses per kWh: Here you set the number of pulses per kWh that are sent to controller.

MENU 5.4 - SOFT IN/OUTPUTS

Here you can select which in/output on the input board (AA3) and the terminal block (X2) the external switch function will be connected to.

Selectable inputs on terminal blocks AUX 1-3 (AA3-X6:9-14) and AUX 4 (X2:1-4) and output AA3-X7.



CAUTION!

The signal for the AUX inputs must be a zero-voltage signal (make-break contact).

Possible configurations AA3-X7:

- Not used,
- Holiday,
- Away mode,
- Alarm output,
- Hot water recirculation,
- Ext heat. med. pump

MENU 5.5 - FACTORY SETTING SERVICE

All settings can be reset (including settings available to the user) to default values here.



NOTE!

When resetting, the start guide is displayed the next time the control module is restarted.

MENU 5.6 - FORCED CONTROL

You can force control the different components in the control module and any connected accessories here.

MENU 5.7 - START GUIDE

When the control module is started for the first time the start guide starts automatically. Start it manually here.

MENU 5.8 - QUICK START

It is possible to start the compressor from here.



NOTE!

There must be a heating, cooling or hot water demand to start the compressor.



CAUTION!

Do not quick start the compressor too many times over a short period of time, as this could damage the compressor and its surrounding equipment.

MENU 5.9 - FLOOR DRYING FUNCTION

length of period 1 - 7

Setting range: 0 - 30 days

Factory setting, period 1 - 3, 5 - 7: 2 days

Factory setting, period 4: 3 days

temp. period 1 - 7

Setting range: 15 - 70 °C

Default value:

temp. period 1	20 °C
temp. period 2	30 °C
temp. period 3	40 °C
temp. period 4	45 °C
temp. period 5	40 °C
temp. period 6	30 °C
temp. period 7	20 °C

Set the function for under floor drying here.

You can set up to seven time periods with different calculated supply temperatures. If fewer than seven periods are to be used, set the remaining periods to 0 days.

Mark the active window to activate the underfloor drying function. A counter at the bottom shows the number of days the function has been active.



TIP!

If operating mode "add. heat only" is to be used, select it in menu 4.2.

MENU 5.10 - CHANGE LOG

Read off any previous changes to the control system here. The date, time, ID no. (unique to particular setting) and the new set value are shown for every change.



NOTE!

The change log is saved at restart and remains unchanged after factory setting.

MENU 5.11 - SLAVE SETTINGS

Settings for installed slaves can be made in the sub menus.

MENU 5.11.1 - EB101

Make settings for the installed slaves here.



CAUTION!

The SHK 20-200 unit cannot be cascaded with heat pumps.

MENU 5.11.1.1 - HEAT PUMP

Make settings for the installed slave here. To see what settings you can make, see the installation manual for the relevant installed slave.

MENU 5.11.1.2 - CHARGE PUMP (GP12)

op. mode

Heating/cooling

Setting range: auto / intermittent

Factory setting: auto

GP10 off, cool. 2-pipe

Setting range: on/off

Factory setting: off

Set the operating mode for the charge pump here.

auto: The charge pump runs according to the current operating mode for SHK 20-200.

intermittent: The charge pump starts and stops 20 seconds before, and after, the compressor in the heat pump.

GP10 off, cool. 2-pipe: This function allows the GP10 pump to be turned off during cooling in a 2-pipe system.

speed during operation

heating, hot water, pool, cooling

Setting range: auto / manual

Factory setting: auto

Manual setting

Setting range: 1-100 %

Factory setting: 70 %

min. allowed speed

Setting range: 1-100 %

Factory setting: 15 %

speed in wait mode

Setting range: 1-100 %

Factory setting: 30 %

max. allowed speed

Setting range: 80-100 %

Factory setting: 100 %

Set the speed at which the charge pump is to operate in the present operating mode. Select "auto" if the speed of the charge pump is to be regulated automatically (factory setting) for optimal operation.

If "auto" is activated for heating operation, you can also make the setting "min. allowed speed" and "max. allowed speed", which restricts the charge pump and prevents it from running at a lower or higher speed than the set value.

For manual operation of the charge pump, deactivate "auto" for the current operating mode and set the value to between 1 and 100% (the previously set value for "max. allowed speed" and "min. allowed speed" no longer applies).

Speed in wait mode (only used if "auto" has been selected for "Operating mode") means the charge pump operates at the set speed during the time when neither compressor operation nor additional heat are required.

5.12 - COUNTRY

Select here the country in which the product was installed. This allows access to country-specific settings in your product.

Language settings can be made regardless of this selection.

**NOTE!**

This option locks after 24 hours, after restarting the display and during program updating.

10 Service

Service actions

! CAUTION!
 Servicing should only be carried out by persons with the necessary expertise.
 When replacing components in the SHK 20-200, only original spare parts should be used.

Emergency mode

! CAUTION!
 Switch (SF1) must not be put into mode „“ before the installation is filled with water. The compressor in the heat pump can be damaged.

Emergency mode is used in event of operational interference and in conjunction with service. Hot water is not produced in emergency mode.

Emergency mode is activated by setting switch (SF1) in mode „“. This means that:

- The status lamp illuminates yellow
- The display is not lit and the control computer is not connected.
- Hot water is not produced.
- The compressors are switched off. Charge pump (EB101-GP12) (if installed) is running.
- Accessories are switched off
- The heating medium pump is active.
- The emergency mode relay (K2) is active.
- Electric module available power - 3kW.

External additional heat is active if it is connected to the emergency mode relay (K2, terminal block X1). Ensure that the heating medium circulates through the external additional heat.

Table of resistance of temperature sensors

Temperature (°C)	Resistance (kΩm)	Voltage (VDC)
-40	351,0	3,256
-35	251,6	3,240
-30	182,5	3,218
-25	133,8	3,189
-20	99,22	3,150
-15	74,32	3,105
-10	56,20	3,047
-5	42,89	2,976
0	33,02	2,889
5	25,61	2,789
10	20,02	2,673
15	15,77	2,541
20	12,51	2,399
25	10,00	2,245
30	8,045	2,083
35	6,514	1,916
40	5,306	1,752
45	4,348	1,587
50	3,583	1,426
55	2,968	1,278
60	2,467	1,136
65	2,068	1,007
70	1,739	0,891
75	1,469	0,758
80	1,246	0,691
85	1,061	0,607
90	0,908	0,533
95	0,779	0,469
100	0,672	0,414

USB service outlet

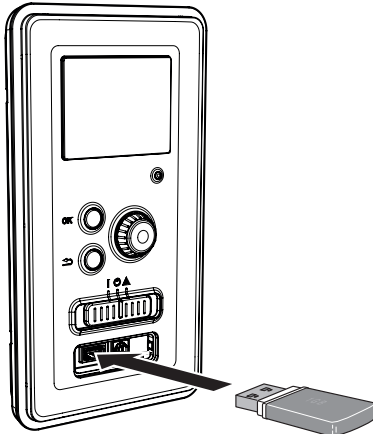

The display unit is equipped with a USB socket that can be used to update the software, save logged information and manage the settings in the controller.

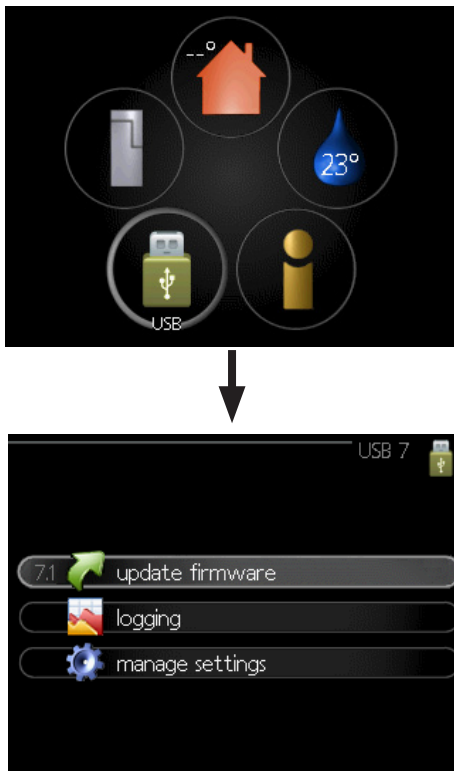

When a USB memory is connected a new menu (menu 7) appears in the display.

Menu 7.1 - update firmware

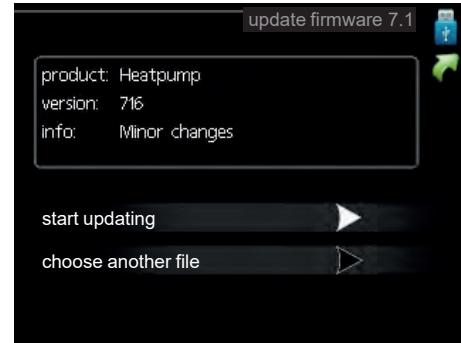

This allows you to update the software in the controller.

CAUTION!
For the following functions to work the USB memory must contain files with software for the controller.

The fact box at the top of the display shows information of the most probable update that the update software has selected from the USB memory.

This information states which product the software is intended for, the software version and general information about them. If you wish to select another file than the one selected, the correct file can be selected by „choose another file“.

start updating

Select “start updating” if you want to start the update. You are asked whether you really want to update the software. Respond „yes” to continue or „no” to undo.

If you responded “yes” to the previous question the update starts and you can now follow the progress of the update on the display. When the update is complete the controller restarts.

CAUTION!
A software update does not reset the menu settings in the controller.

CAUTION!
If the update is interrupted before it is complete (for example power cut etc.), the software can be reset to the previous version if the OK button is held in during start up until the green lamp starts to illuminate (takes about 10 seconds).

Choose another file



Select "choose another file" if you do not want to use the suggested software. When you scroll through the files, information about the marked software is shown in a fact box just as before. When you have selected a file with the OK button you will return to the previous page (menu 7.1) where you can choose to start the update.

Menu 7.2 - logging



Setting range: 1 s – 60 min
Factory setting range: 5 s

Here you can choose how current measurement values from the controller should be saved onto a log file on the USB memory.

1. Set the desired interval between loggings.
2. Tick "activated".
3. The present values from the controller are saved in a file in the USB memory at the set interval until "activated" is unticked.

CAUTION!
Untick „activated“ before removing the USB memory. Otherwise, saved data may be lost.

Menu 7.3 - manage settings

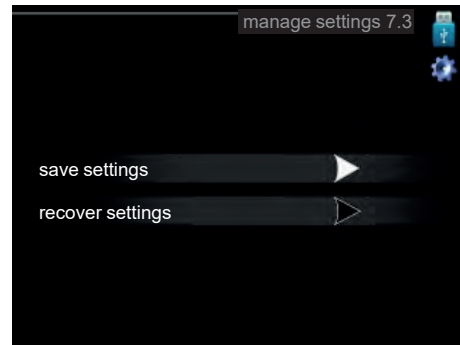

Here you can manage (save as or retrieve from) all the menu settings (user and service menus) in the controller with a USB memory.

Via „save settings“ you save the menu settings to the USB memory in order to restore them later or to copy the settings to another controller.

CAUTION!
When you save the menu settings to the USB memory you replace any previously saved settings on the USB memory.

CAUTION!
Reset of the menu settings from the USB memory cannot be undone.

Emptying the hot water tank

For emptying the hot water tank the siphon principle applies. This can be done via the drain valve on the cold water supply pipe or by placing a hose in the cold water connection.

Emptying the heating system

To facilitate the servicing of the heating system, it must first be emptied using the filling valve.

1. Connect the hose to the external drain valve of the system.
2. Then open the drain valve to empty the heating system.



CAUTION!

When emptying the side of the heating medium / heating system, remember that they may contain hot water. There is a risk of burns.

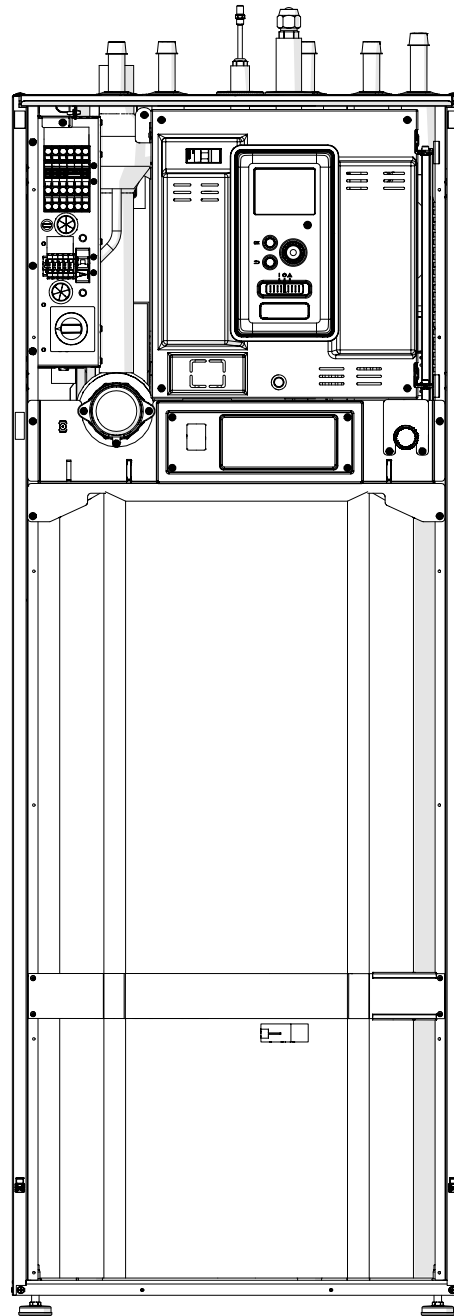

11 Disturbances in comfort

In most cases, the control module notes a malfunction and indicates this with alarms and shows instructions to rectify it in the display. See „Manage alarm” for information about managing alarms. If the malfunction does not appear in the display, or if the display is not lit, the following troubleshooting guide can be used.

In the event of an alarm, some kind of malfunction has occurred, which is indicated by the status lamp changing from green continuously to red continuously. In addition, an alarm bell appears in the information window.

Alarm

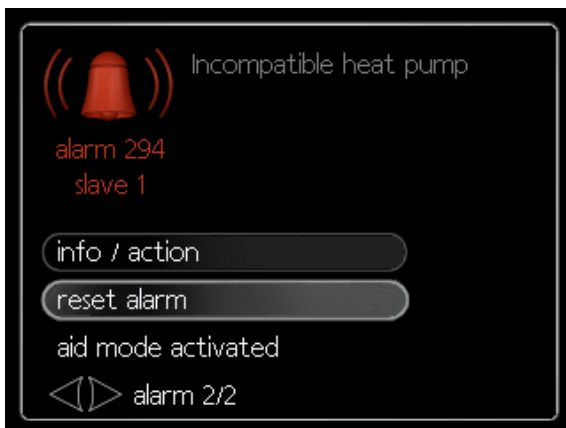

In the event of an alarm with a red status lamp a malfunction has occurred that the heat pump and/or control module cannot remedy itself. In the display, by turning the control knob and pressing the OK button, you can see the type of alarm it is and reset it. You can also choose to set the installation to aid mode.

info / action Here you can read what the alarm means and receive tips on what you can do to correct the problem that caused the alarm.

reset alarm In many cases, it is sufficient to select “reset alarm” in order for the product to revert to normal operation. If a green light comes on after selecting “reset alarm”, the alarm has been remedied. If a red light is still visible and a menu called “alarm” is visible in the display, the problem that caused the alarm remains. If the alarm disappears and then returns, contact the installer.

reset alarm “aid mode” is a type of emergency mode. This means that the installation produces heat and/or hot water despite there being some kind of problem. This can mean that the heat pump’s compressor is not running. In this case any electrical addition produces heat and/or hot water.



NOTE!
Selecting „aid mode” is not the same as correcting the problem that caused the alarm. The status lamp will therefore continue to be red.

If the alarm has not been reset, contact the installer for proper repair.



CAUTION!

When reporting a fault, always enter the serial number of the product (14 digits) found on the nameplate (PF1).

Troubleshooting

If the operational interference is not shown in the display the following tips can be used:

Basic actions

Start by checking the following items:

- The switch’s position.
- Group and main fuses of the accommodation.
- The control module’s miniature circuit breaker.
- Correctly set load monitor (if installed).

Low hot water temperature or no hot water

This part of the fault-tracing chapter only applies if the water heater is installed in the system.

- Closed or choked filling valve for the hot water.
 - Open the valve.
- Mixing valve (if there is one installed) set too low.
 - Adjust the mixer valve.
- Control module in incorrect operating mode.
 - If mode „manual” is selected, select „addition”.
- Large hot water consumption.
 - Wait until the hot water has heated up. Temporarily increased hot water capacity (temporary lux) can be activated in menu 2.1..
- Too low hot water setting.
 - Enter menu 2.2 and select a higher comfort mode
- Too low or no operating prioritisation of hot water.
 - Enter menu 4.9.1 and increase the time for when hot water is to be prioritised.

Low room temperature

- Closed thermostats in several rooms.
 - Set the thermostats to max, in as many rooms as possible.
- Adjust the room temperature via menu 1.1, instead of choking the thermostats.
- Control module in incorrect operating mode.
 - Enter menu 4.2. If mode „auto” is selected, select a higher value on „stop heating” in menu 4.9.2.
 - If mode „manual” is selected, select „heating”. If this is not enough, select „addition”.
- Too low set value on the automatic heating control.
 - Enter menu 1.1 „temperature” and adjust the offset heating curve up. If the room temperature is only low in cold weather the curve slope in menu 1.9.1 „heating curve” needs adjusting up.

- Too low or no operating prioritisation of heat.
 - Enter menu 4.9.1 and increase the time for when heating is to be prioritised.
- „Holiday mode” activated in menu 4.7.
 - Enter menu 4.7 and select „Off”.
- External switch for changing the room heating activated.
 - Check any external switches.
- Air in the climate system.
 - Vent the climate system.
 - Open the valves (contact the installer to locate them).

High room temperature

- Too high set value on the automatic heating control.
 - Enter menu 1.1 (temperature) and reduce the offset heating curve. If the room temperature is only high in cold weather the curve slope in menu 1.9.1 „heating curve” needs adjusting down.
- External switch for changing the room heating activated.
 - Check any external switches.

The compressor does not start

- There is no heating requirement.
 - The controller does not call on heating or hot water.
- Compressor blocked due to the temperature conditions.
 - Wait until the temperature is within the product's working range.
- Minimum time between compressor starts has not been reached.
 - Wait 30 minutes and then check if the compressor has started.
- Alarm tripped.
 - Follow the display instructions.

Additional heating only

If you are unsuccessful in rectifying the fault and are unable to heat the house, you can, whilst waiting for assistance, continue running the heat pump in "add. heat only". This means that additional heating only is used to heat the house.

Set the installation to additional heat mode

1. Go to menu 4.2 op. mode.
2. Mark "add. heat only" using the control knob and then press the OK button.
3. Return to the main menus by pressing the Back button.



NOTE!

When commissioning without METRO THERM air/water heat pump, the communication error alarm may appear in the display. The alarm is reset if the relevant heat pump is deactivated in menu 5.2.2 („installed slaves”).

12 Accessories

Automatic gas separator AGS 10

Intended for METROAIR L10.1 / SHK 20-200/12.
An automatic air separator must be installed when the length of the pipe between METROAIR L10.1 and SHK 20-200/12 air/water heat pump exceeds 15 m.

Part no. 067 829

Room sensor RTS 40

This accessory is used to obtain a more even indoor temperature.

Part no. 067 065

Extra shunt group ECS 40/ECS 41

This accessory is used when the controller is installed in houses with two or more different heating systems that require different supply temperatures.

ECS 40 (maks. 80m²)

Part no. 067 287

ECS 41 (maks. 250m²)

Part no. 067 288

Accessory card AXC 40

An accessory board is required in case of active cooling (4-pipe system), an additional climate system, or if more than four feed pumps are to be connected to the controller. It can also be used in case of additional heat controlled by a shunt valve (e.g. wood/oil/gas/pellet boiler). An accessory board is required if, for example, a hot water circulation pump is to be connected to the controller where the AA3-X7 output is activated for the QN12 valve.

Part no. 067 304

Communications module MODBUS 40

MODBUS 40 enables controller to be controlled and monitored using a BMS (building management system) in the building. Communication is then performed using MODBUS-RTU.

Part no. 067 144

Room unit RMU 40

RMU 40 means that control and monitoring of the controller can be carried out in a different part of your home to where it is located.

Part no. 067 064

Pool unit POOL 40

POOL 40 is used to enable pool heating with SHK 20-200.

Part no. 067 062

Air/water heat pump

L6.1

Part no. 31491

L10.1

Part no. 31495

Condensation water drainage pipe

KVR10-10

Length - 1 meter

Part no. 067 614

KVR10-30

Length - 3 metres

Part no. 067 616

KVR10-60

Length - 6 meters

Part no. 067 618

More accessories are available on the website
<https://www.nathan.nl>

Connecting the KVR accessory

The KVR 10 accessory is used to safely drain off most of the condensate from the air/water heat pump to a frost-free collection point.

HYDRAULIC CONNECTION

For information on hydraulic connection of the KVR 10 accessory, see the instructions for the KVR accessory.

ELECTRICAL CONNECTION

In order to connect the electric KVR accessory:

1. Open the control panel and knock out the notched plate in the control panel housing under the residual current device. Remove the panel housing.
2. Disconnect the wires and remove the cube. Fix the residual current device on the bar.

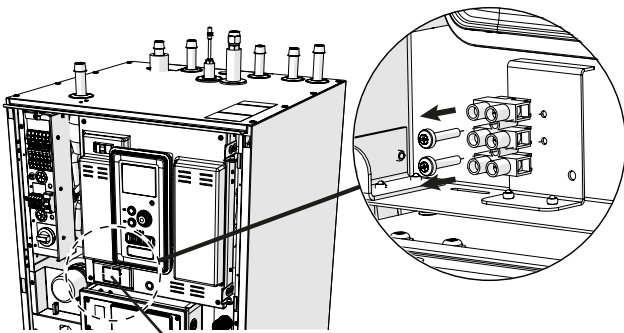
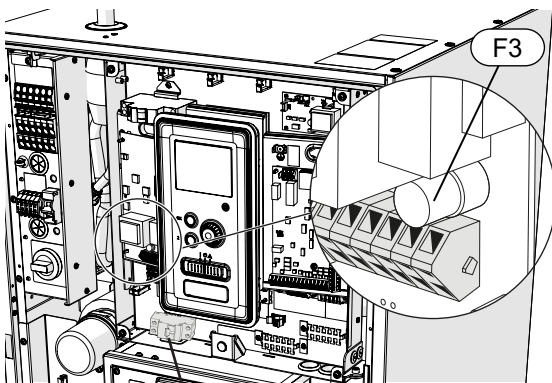

Plate to be punched-out

3. Use fuse (F3) depending on the length of the KVR cable in accordance with the below table.



Residual-current device RCD

Length (m)	P _{tot} (W)	Fuse (F3)	Part no.
1	15	T100mA/250V	718 085
3	45	T250mA/250V	518 900*
6	90	T500mA/250V	718 086

*Fitted at the factory

4. Connect a residual-current device to terminal AA2-X1 under terminal block 5(N) and 6(L).

5. Connect a residual-current device to terminal AA23-X1 to terminal blocks 1 (L) and 2 (N).
6. Connect an external heating cable (EB14) to terminal AA23-X1 to terminal blocks: 4 (PE), 5 (N), 6 (L).

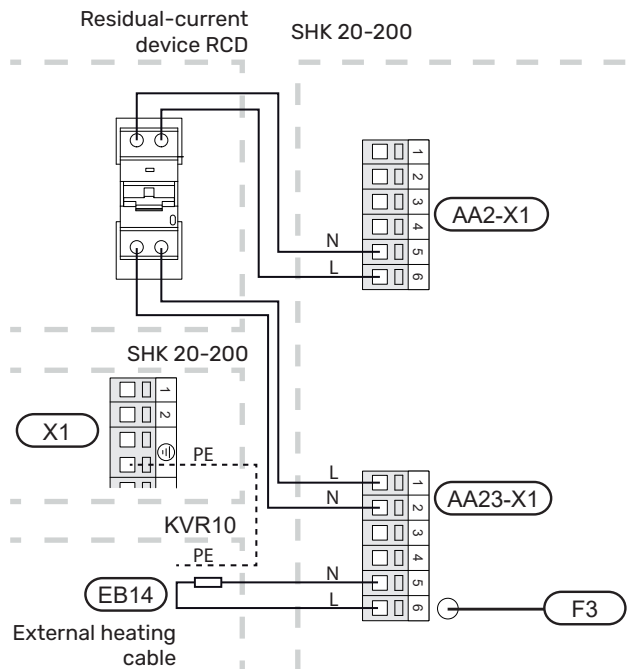
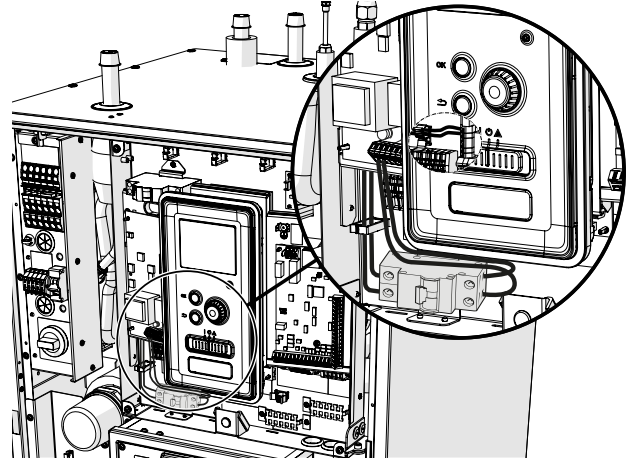

Connecting an additional heat source

The SHK 20-200 can be connected to an additional heat source (e.g. a gas boiler, solid fuel boiler).

NOTE!
When using an additional heat source (e.g. gas boiler, solid fuel boiler), the built-in electric auxiliary heater will not be used.

Additional heat source connected before QN10 (replacing the built-in auxiliary heater) must not have a power greater than 15 kW and should be connected to the contactor K1A. Short-circuit of potential-free contacts K1A gives a signal to switch on an additional heat source.

HYDRAULIC CONNECTION

The hydraulic connection should be made to connections XL 18 and 19 in accordance with „Diagram showing connection of an additional heat source” in section 4 Pipe connections.

ELECTRICAL CONNECTION

In order to make a correct electrical connection to the control (potential-free):

1. Disconnect the device from the power supply.
2. In the case of connecting the unit to 400V, convert the connection to 230V.
3. Disconnect the B02 jumper as shown in the drawing below (detailed diagram in the subsection „Wiring diagrams”).
4. Connect the wires from the additional heat source (e.g. gas boiler) to the terminals of the K1A: 3 and K1A: 4 relay as shown in the figure below.

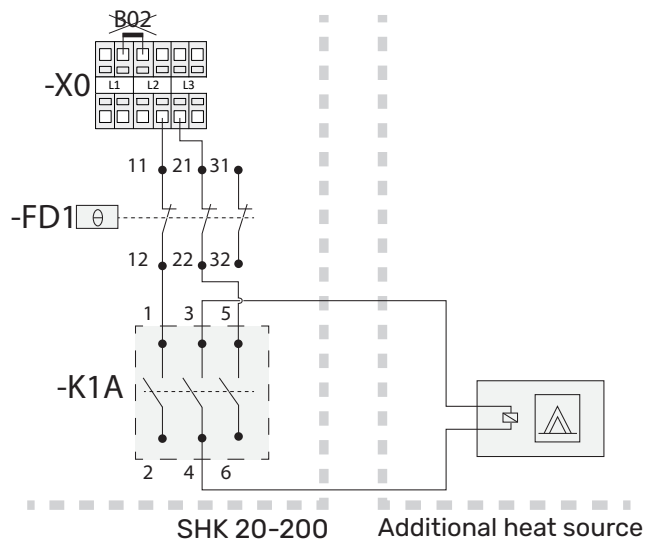

5. Connect the device to the power supply and start the SHK unit.
6. In menu 5.1.12, change the setting according to the screenshot and description below.

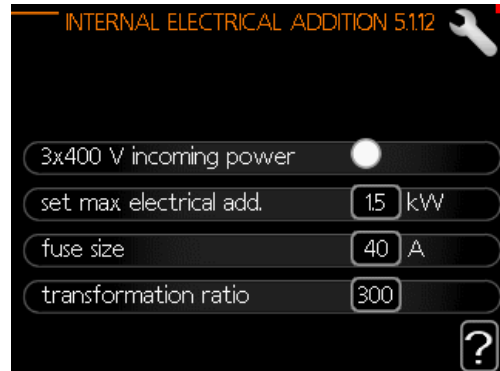

Description of settings:
3x400 V incoming power: off
set max electrical add.: 1.5 kW
fuse size: 40A (recommended value)
transformation ratio: 300

NOTE!
To run an additional heat source (e.g. a gas boiler), the fuse size must be set at least 7A higher than the required compressor run value

In the absence of current limitation, the recommended fuse size is 40A.

CAUTION!
Setting the fuse size too low may result an wrong operation in additional heat source and/or compressor power limitation.

Connecting the expansion card

Communication connection

The expansion card communication should be connected directly to the SHK 20-200 to the AA23 card according to the diagram below.

When connecting or installing more than one accessory, observe the following.

The first expansion card should be connected directly to the AA23-X4 terminal block on the SHK 20-200, and the following cards should be connected in series with the previous one.

Use cables type LiYY, EKKX or similar.

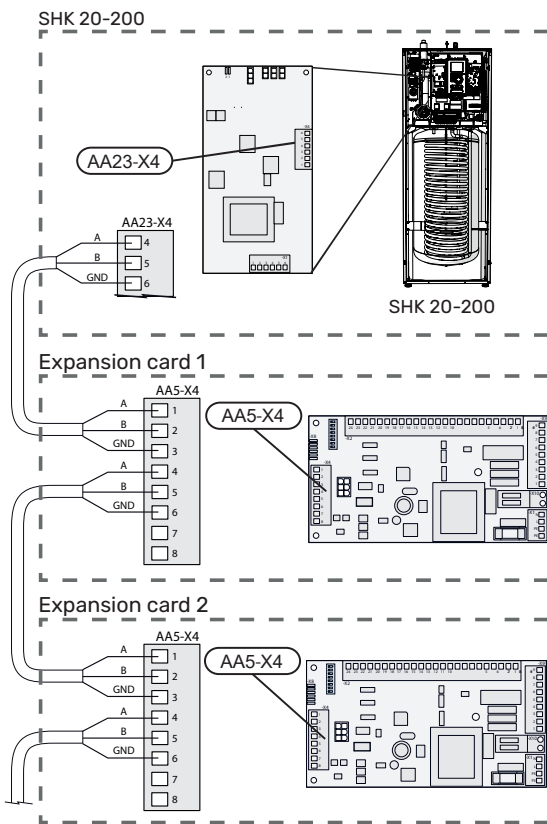

For detailed information on using the expansion card, see the installer manual for the AXC 30 accessory.

Power connection

Connect the power to terminal X1 as shown in the figure.

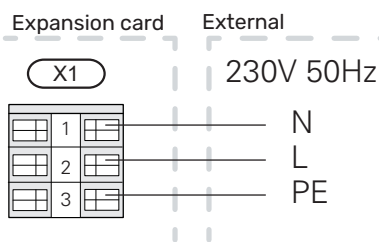

Connection of an additional GP10 pump

To connect an additional GP10 circulation pump, proceed as follows:

- connect wire L to the terminal block AA2-X4: 11
- connect wire N to the terminal block AA2-X4: 10
- connect wire PE to the terminal AA2-X4: 9

All connections should be made in accordance with the figure below.

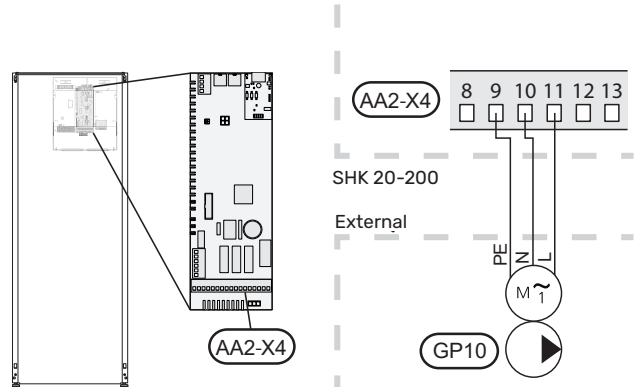
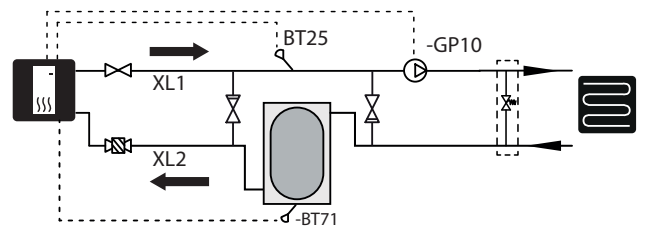
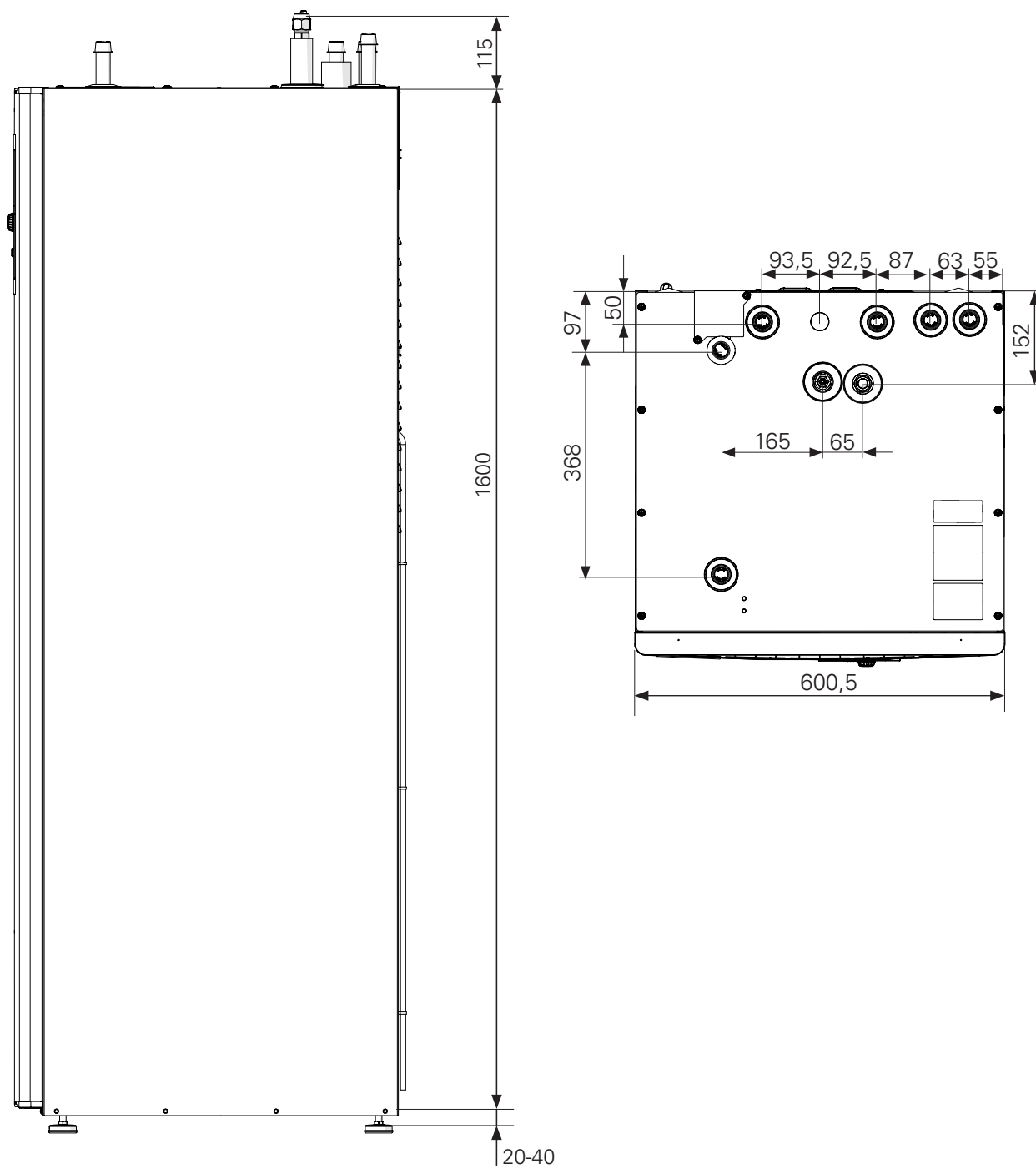

Diagram with buffer tank connected in series-parallel and additional circulation pump GP10.



13 Technical data



Technical data

SHK 20-200

Product type	Unit	SHK 20-200/6	SHK 20-200/12
Height	mm	1720	
Required room height	mm	2100	
Width	mm	600	
Depth	mm	610	
Weight	kg	155	165
Maximum operating pressure of central heating system	bar	3	
Minimum operating pressure of central heating system	bar	0,5	
Maximum hot water pressure	bar	10	
Minimum hot water pressure	bar	2	
Hot water tank volume	l	180	
Maximum operating temperature of central heating	°C	70	
Low-energy circulation pump clim. sys.	-	Yes	
Safety valve. climate system	-	Yes, in the safety assembly	
Expansion vessel	l	10	
Additional heat	kW	4,5 (230 V) / 9 (400 V)	
Plate heat exchanger power	kW	6	9
Rated voltage	V	1x230 / 3x400	
Hot water tank corrosion protection	-	Enamel + titanium anode	
Refrigerant type	-	R32	
Maximum hot water capacity in accordance with EN16147	-	230 l 40°C	
Energy class (acc. to ErP, at supply temp. 55°C) (Applies to L10.1 + SHK 20-200/12 i L6.1 + SHK 20-200/6	-	A++	
Performance class / Load profile (DHW)	-	A/XL	

METROAIR L

Outdoor module	Unit	L6.1	L10.1
Output data according to EN 14 511, partial load ¹			
Heating	-7 / 35°C	5.55 / 2.05 / 2.71	7.18 / 2.93 / 2.45
Capacity / power input / COP (kW/kW/-) at nominal flow Outdoor temp. / Supply temp.	2 / 35°C	2.31 / 0.56 / 4.13	3.46 / 0.83 / 4.17
	2 / 45°C	2.02 / 0.67 / 3.01	3.24 / 1.12 / 3.24
	7 / 35°C	2.64 / 0.49 / 5.42	4.00 / 0.75 / 5.33
	7 / 45°C	2.43 / 0.65 / 3.74	5.00 / 1.28 / 3.91
	35 / 7 °C	5.32 / 1.94 / 2.74	7.07 / 2.40 / 2.95
Cooling Capacity / power input / EER (kW/kW/-) at maximum flow Outdoor temp: / Supply temp.	35 / 18 °C	7.55 / 2.11 / 3.58	10.79 / 3.00 / 3.60
SCOP according to EN 14825			
Nominal heat output ($P_{designh}$) average climate 35 °C / 55 °C (Europe)	kW	5.20 / 5.60	6.3 / 6.5
Nominal heat output ($P_{designh}$) cold climate 35 °C / 55 °C	kW	5.80 / 5.70	6.5 / 6.2
Nominal heat output ($P_{designh}$) warm climate 35 °C / 55 °C	kW	5.57 / 5.48	6.9 / 6.6
SCOP average climate, 35 °C / 55 °C (Europe)		5.08 / 3.58	4.6 / 3.4
SCOP cold climate, 35 °C / 55 °C		4.10 / 3.05	3.9 / 2.9
SCOP warm climate, 35 °C / 55 °C		6.76 / 4.55	6.4 / 4.4
Energy rating, average climate ²			
The product's room heating efficiency class 35 C / 55 C ³		A++ / A++	
The system's room heating efficiency class 35 C / 55 C ⁴		A+++ / A++	
Electrical data			
Rated voltage		230 V 50 Hz, 230 V 2 AC 50 Hz	
Max operating current, heat pump	A_{rms}	15	16
Max operating current, compressor	A_{rms}	14	15
Max. power, fan	W	50	86
Drain pan heating (integrated)	W	110	100
Fuse	A_{rms}	16	
Starting current	A_{rms}	5	
Enclosure class		IP24	
Refrigerant circuit			
Type of refrigerant		R32	
GWP refrigerant		675	
Volume	kg	1.3	1.84
Type of compressor		Twin Rotary	
CO ₂ -equivalent (The cooling circuit is hermetically sealed.)	t	0.88	1.24
Cut-out value pressure switch HP (BP1)	MPa (bary)	-	4,15 (41,5)
Cut-out value pressure switch LP (BP2)	MPa (bary)	-	0,079 (0,79)
Max. length, refrigerant pipe, one way	m	30	50
Max height difference, when METROAIR L is placed higher than SHK 20-200	m	20	30
Max height difference, when METROAIR L is placed lower than SHK 20-200	m	20	15

Dimensions, refrigerant pipes, Gas pipe/Liquid pipe ⁵	mm	12.7 (1/2") / 6.35 (1/4")	15.88 (5/8") / 6.35 (1/4")
Airflow			
Max airflow	m ³ /h	2,530	3,000
Working area			
Min./max. air temperature, heating	°C	-20 / 43	
Min./max. air temperature, cooling	°C	15 / 43	
Defrosting system		Reverse cycle	
Pipe connections			
Pipe connection option		Right-hand side	
Pipe connections		Flare	
Dimensions and weight			
Width	mm	800	880 (+67 valve cover)
Depth	mm	290	340 (+ 110 with foot rail)
Height with stand	mm	640	750
Weight	kg	46	60
Miscellaneous			
Part no.		31491	31495

¹ Power statements including defrosting according to EN 14511 at heating medium supply corresponding to DT=5 K at 7 / 45.

² Reported efficiency for the system also takes the temperature regulator into account. If the system is supplemented with an external auxiliary boiler or solar heating, the total efficiency of the system must be recalculated.

³ Scale for the product's room heating efficiency class A++ to G. Control module model SMO S.

⁴ Scale for the system's room heating efficiency class A+++ to G. Control module model SMO S

⁵ If the length of the refrigerant pipes exceeds 15 metres, extra refrigerant must be added at 0.02 kg/m. Use the enclosed label to re-mark the unit with the new amount of refrigerant.

Max. operating current and recommended fuse rating for 3x400 V connection	Unit	SHK 20-200/6 + L6.1	SHK 20-200/12 + L10.1
Max. operating current, compressor	A	16	16
Max. operating current of heat pump including 3 kW immersion heater, compressor running and contactor K1 connected (recommended fuse rating)	A	16 (16)	16 (16)
Max. operating current of heat pump including 6 kW immersion heater, compressor running and contactor K1+K2 connected (recommended fuse rating)	A	16 (16)	16 (16)
Max. operating current of heat pump including 9 kW immersion heater, compressor running and contactor K1+K2+K3 connected (recommended fuse rating)	A	20 (20)	20 (20)
Max. operating current of 9 kW immersion heater, contactor K1+K2+K3 connected, compressor not running (recommended fuse rating)	A	20 (20)	20 (20)

Max. operating current and recommended fuse rating for 1x230 V connection	Unit	SHK 20-200/6 + L6.1	SHK 20-200/12 + L10.1
Max. operating current, compressor	A	16	16
Max. operating current of heat pump including 1.5 kW immersion heater, compressor running and contactor K1 connected (recommended fuse rating)	A	22,5 (25)	22,5 (25)
Max. operating current of heat pump including 3 kW immersion heater, compressor running and contactor K1+K2 connected (recommended fuse rating)	A	29 (32)	29 (32)
Max. operating current of heat pump including 4.5 kW immersion heater, compressor running and contactor K1+K2+K3 connected (recommended fuse rating)	A	35,5 (32)	35,5 (32)
Max. operating current of 4.5 kW immersion heater, contactor K1+K2+K3 connected, compressor not running (recommended fuse rating)	A	19,5 (20)	19,5 (20)

Energy efficiency label

Manufacturer	METRO THERM		
Heat pump model		L6.1	L10.1
Hot water heater model		SHK 20-200/6	SHK 20-200/12
Temperature application	°C	35 / 55	35 / 55
Space heating efficiency class, average climate		A+++ / A++	
Nominal heat output ($P_{designh}$), average climate	kW	5 / 6	6 / 6
Annual energy consumption for space heating, average climate	kWh	2 116 / 3 250	2 834 / 3 961
Seasonal average space heating efficiency, average climate	%	200 / 139	181 / 132
Sound power level L_{WA} indoors	dB	35	
Rated heat output ($P_{designh}$), cold climate	kW	6 / 6	7 / 6
Rated heat output ($P_{designh}$), warm climate	kW	6 / 5	7 / 7
Annual energy consumption space heating, cold climate	kWh	3 487 / 4 604	4 059 / 5 204
Annual energy consumption space heating, warm climate	kWh	1 110 / 1 617	1 379 / 1 964
Seasonal space heating energy efficiency, cold climate	%	161 / 119	155 / 114
Water heating energy efficiency, cold climate	%	265 / 178	260 / 177
Sound power level L_{WA} outdoors	dB	54	54

Energy efficiency specifications of the package

Heat pump model		L6.1	L10.1
Hot water heater model		SHK 20-200/6	SHK 20-200/12
Temperature application	°C	35 / 55	35 / 55
Controller, class		VI	
Controller, contribution to efficiency	%	4,0	
Seasonal space heating energy efficiency of the package, average climate	%	204 / 143	185 / 136
Seasonal space heating energy efficiency class of the package, average climate		A+++ / A++	
Seasonal space heating energy efficiency of the package, cold climate	%	165 / 123	159 / 118
Seasonal space heating energy efficiency of the package, warm climate	%	269 / 182	264 / 181

A+++ - D for product space heating
 A+++ - G for package space heating
 A+ - F for product domestic hot water

The reported efficiency of the system also takes the controller into account. If an external supplementary boiler or solar heating is added to the system, the overall efficiency of the system should be recalculated.

Energy label

Model		L6.1 + SHK 20-200/6					
Type of heat pump	<input checked="" type="checkbox"/> Air-water <input type="checkbox"/> Exhaust-water <input type="checkbox"/> Brine-water <input type="checkbox"/> Water-water						
Low-temperature heat pump	<input type="checkbox"/> Yes <input checked="" type="checkbox"/> No						
Integrated immersion heater for additional heat	<input checked="" type="checkbox"/> Yes <input type="checkbox"/> No						
Heat pump combination heater	<input checked="" type="checkbox"/> Yes <input type="checkbox"/> No						
Climate	<input checked="" type="checkbox"/> Average <input type="checkbox"/> Cold <input type="checkbox"/> Warm						
Temperature application	<input checked="" type="checkbox"/> Average (55°C) <input type="checkbox"/> Low (35°C)						
Applied standards	EN14825 / EN16147, EN14511 and EN12102						
Rated heat output	Prated	5.6	kW	Seasonal space heating energy efficiency	η_s	139	%
Declared capacity for space heating at part load and at outdoor temperature T_j				Declared coefficient of performance for space heating at part load and at outdoor temperature T_j			
$T_j = -7^\circ\text{C}$	P_{dh}	5.0	kW	$T_j = -7^\circ\text{C}$	P_{dh}	1.95	-
$T_j = +2^\circ\text{C}$	P_{dh}	2.9	kW	$T_j = +2^\circ\text{C}$	P_{dh}	3.51	-
$T_j = +7^\circ\text{C}$	P_{dh}	1.9	kW	$T_j = +7^\circ\text{C}$	P_{dh}	4.99	-
$T_j = +12^\circ\text{C}$	P_{dh}	1.7	kW	$T_j = +12^\circ\text{C}$	P_{dh}	6.33	-
$T_j = \text{biv}$	P_{dh}	5.0	kW	$T_j = \text{biv}$	P_{dh}	1.95	-
$T_j = \text{TOL}$	P_{dh}	4.6	kW	$T_j = \text{TOL}$	P_{dh}	1.75	-
$T_j = -15^\circ\text{C}$ (if $\text{TOL} < -20^\circ\text{C}$)	P_{dh}		kW	$T_j = -15^\circ\text{C}$ (if $\text{TOL} < -20^\circ\text{C}$)	P_{dh}		-
Bivalent temperature	T_{biv}	-7	°C	Min. outdoor air temperature	TOL	-10	°C
Cycling interval capacity	P_{cyc}		kW	Cycling interval efficiency	COP-cyc		-
Degradation coefficient	C_{dh}	0.96	-	Max supply temperature	WTOL	58	°C
Power consumption in modes other than active mode				Additional heat			
Off mode	P_{OFF}	0.007	kW	Rated heat output	P_{sup}	1.0	kW
Thermostat-off mode	P_{TO}	0.011	kW				
Standby mode	P_{SB}	0.011	kW	Type of energy input	Electric		
Crankcase heater mode	P_{CK}	0.000	kW				
Other items							
Capacity control	Variable			Rated airflow (air-water)		2 340	m ³ /h
Sound power level, indoors/outdoors	L_{WA}	35 / 54	dB	Rated heating medium flow			m ³ /h
Annual energy consumption	Q_{HE}	3 250	kWh	Brine flow rate in brine-water or water-water heat pumps			m ³ /h

Model				L10.1 + SHK 20-200/12					
Type of heat pump		<input checked="" type="checkbox"/> Air-water <input type="checkbox"/> Exhaust-water <input type="checkbox"/> Brine-water <input type="checkbox"/> Water-water							
Low-temperature heat pump		<input type="checkbox"/> Yes <input checked="" type="checkbox"/> No							
Integrated immersion heater for additional heat		<input checked="" type="checkbox"/> Yes <input type="checkbox"/> No							
Heat pump combination heater		<input checked="" type="checkbox"/> Yes <input type="checkbox"/> No							
Climate		<input checked="" type="checkbox"/> Average <input type="checkbox"/> Cold <input type="checkbox"/> Warm							
Temperature application		<input checked="" type="checkbox"/> Average (55°C) <input type="checkbox"/> Low (35°C)							
Applied standards		EN14825 / EN16147, EN14511 and EN12102							
Rated heat output	Prated	6.5	kW	Seasonal space heating energy efficiency	η_s	132	%		
Declared capacity for space heating at part load and at outdoor temperature Tj				Declared coefficient of performance for space heating at part load and at outdoor temperature Tj					
Tj=-7°C	Pdh	5.8	kW	Tj=-7°C	Pdh	1.98	-		
Tj=+2°C	Pdh	3.5	kW	Tj=+2°C	Pdh	3.17	-		
Tj=+7°C	Pdh	2.3	kW	Tj=+7°C	Pdh	4.98	-		
Tj=+12°C	Pdh	2.2	kW	Tj=+12°C	Pdh	5.50	-		
Tj=biv	Pdh	5.8	kW	Tj=biv	Pdh	1.98	-		
Tj=TOL	Pdh	5.8	kW	Tj=TOL	Pdh	1.69	-		
Tj=-15°C(if TOL<-20°C)	Pdh		kW	Tj=-15°C(if TOL<-20°C)	Pdh		-		
Bivalent temperature		T _{biv}	-7	°C	Min. outdoor air temperature		TOL	-10	°C
Cycling interval capacity		P _{cych}		kW	Cycling interval efficiency		COP-cyc		-
Degradation coefficient		Cdh	0.98	-	Max supply temperature		WTOL	60	°C
Power consumption in modes other than active mode				Additional heat					
Off mode	P _{OFF}	0.003	kW	Rated heat output		P _{sup}	0.7	kW	
Thermostat-off mode	P _{TO}	0.008	kW						
Standby mode	P _{SB}	0.008	kW	Type of energy input		Electric			
Crankcase heater mode	P _{CK}	0	kW						
Other items									
Capacity control	Variable			Rated airflow (air-water)			3 000	m³/h	
Sound power level, indoors/outdoors	L _{WA}	35 / 54	dB	Rated heating medium flow				m³/h	
Annual energy consumption	Q _{HE}	3 961	kWh	Brine flow rate in brine-water or water-water heat pumps				m³/h	

Electrical wiring diagrams

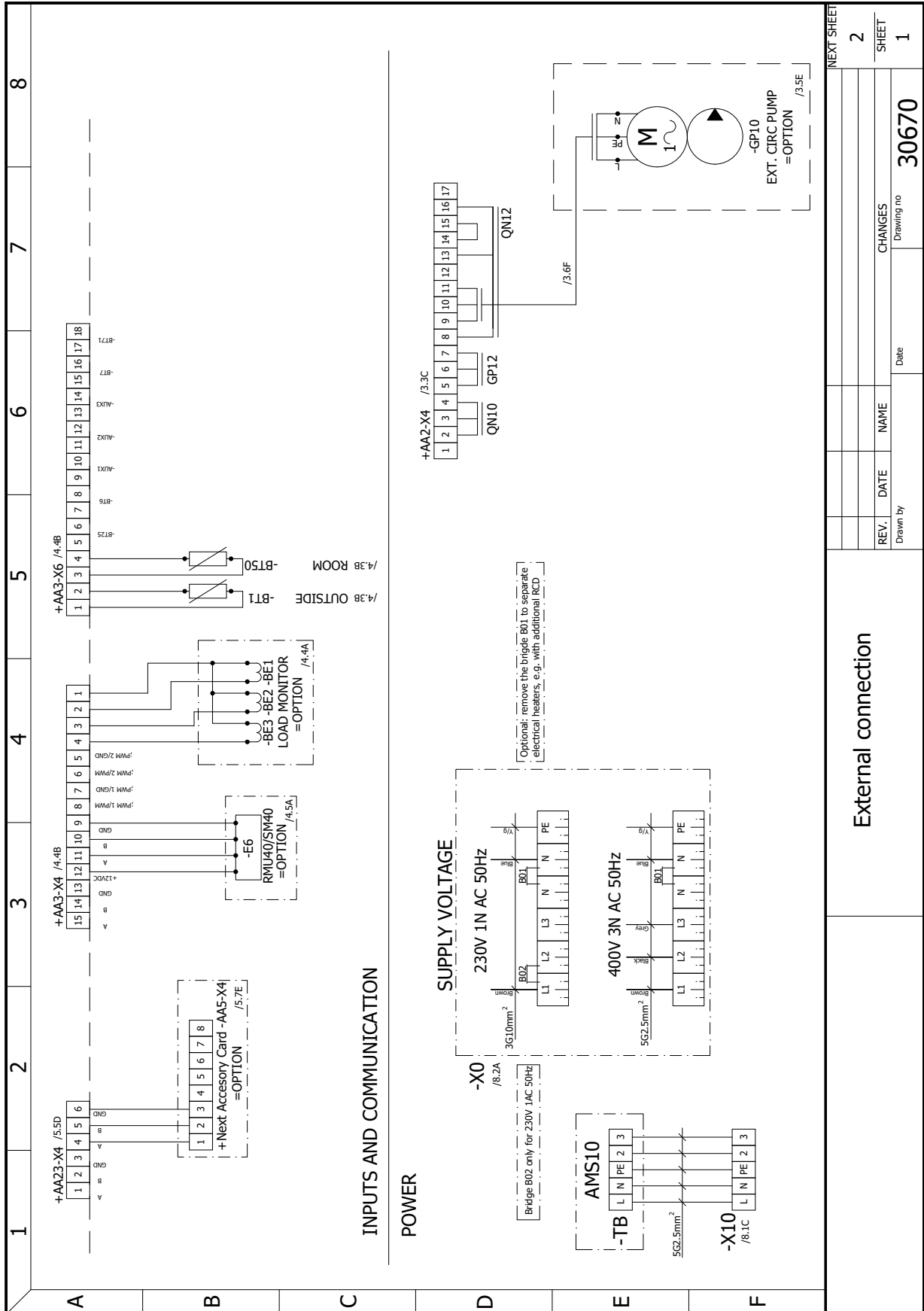

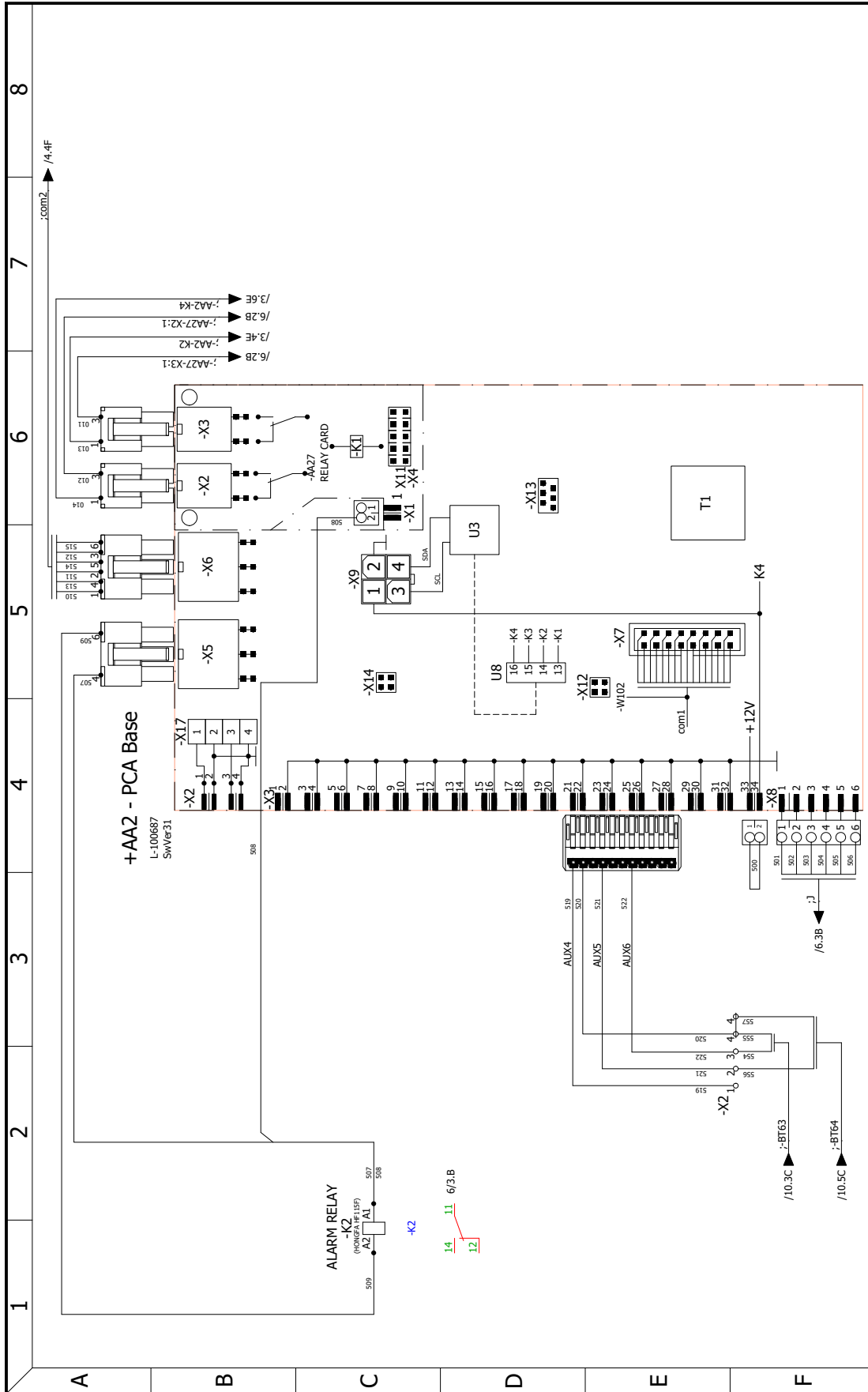

AA2 PCA Base I/O				REV.	DATE	NAME	CHANGES	Drawing no 30670	SHEET 2
				Drawn by			Date		
NEXT SHEET				3					

1 2 3 4 5 6 7 8

+AA2 - PCA Base

L-100687
SwVer31

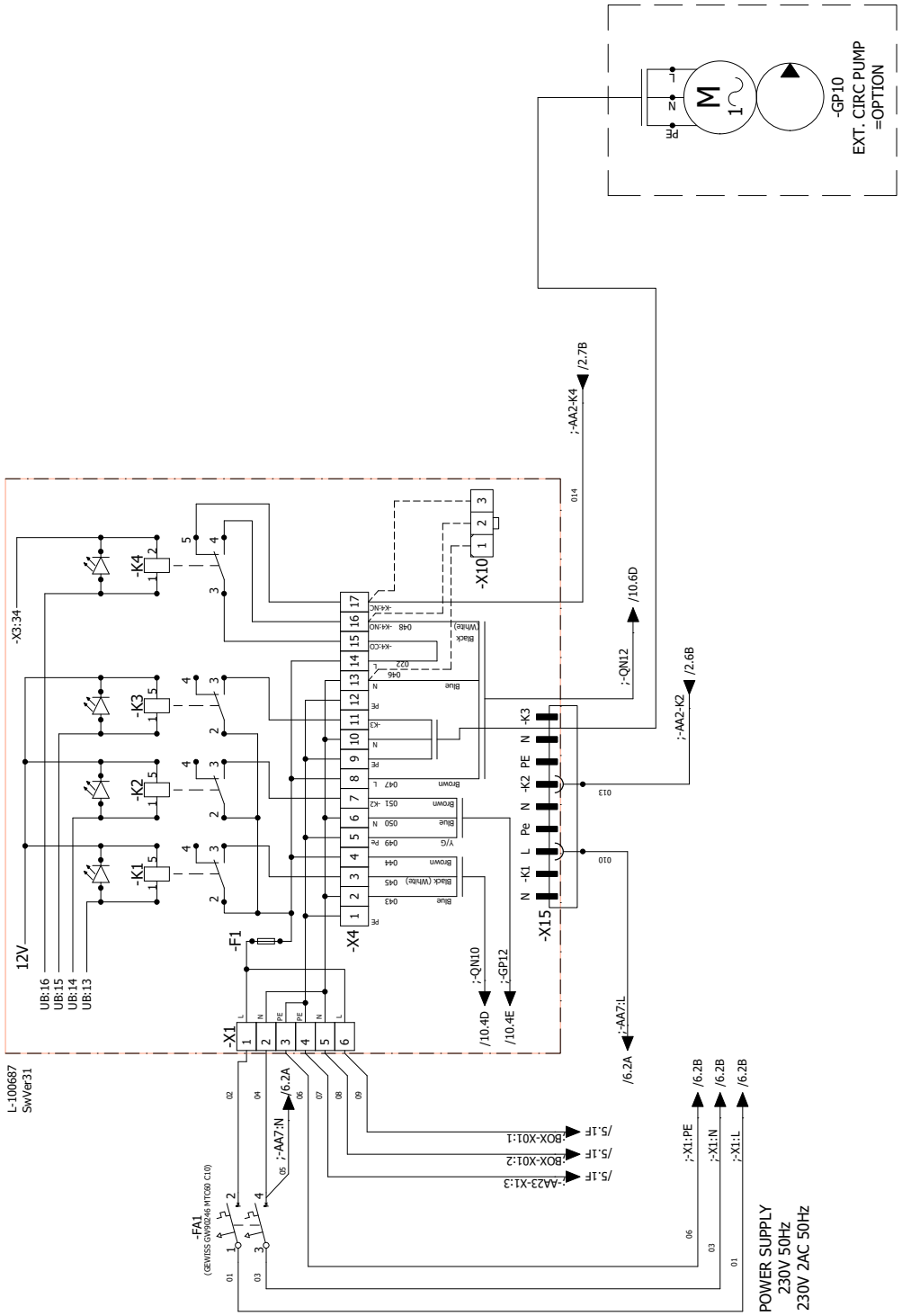

REV.	DATE	NAME	CHANGES
4			
3			

Drawn by: **30670**
Date:

AA2 PCA Base Power	
NEXT SHEET	4
SHEET	3

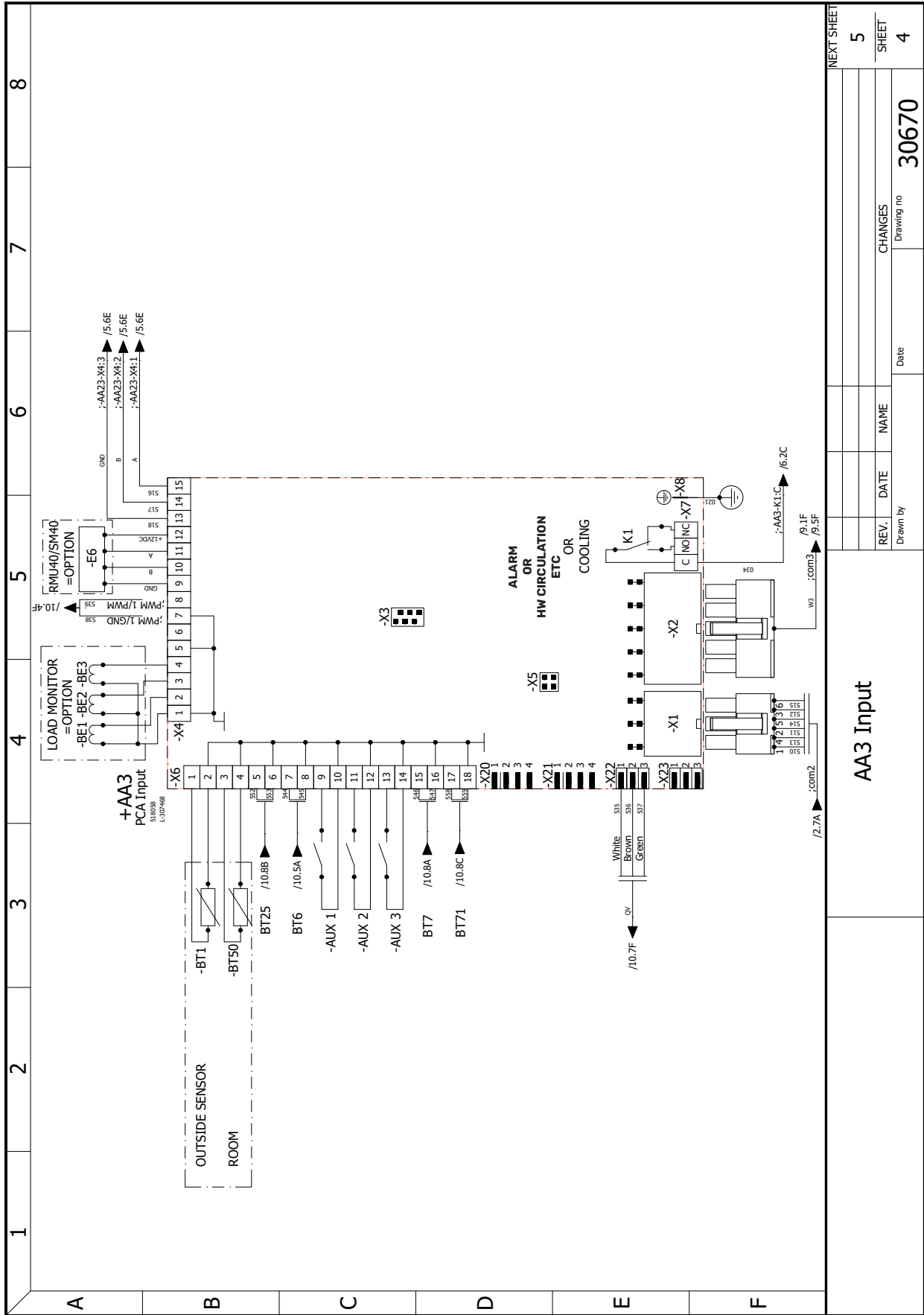

AA3 Input

REV.	DATE	NAME	Date
Drawn by			
CHANGES			Drawing no
			30670
NEXT SHEET			5
SHEET			4

1 2 3 4 5 6 7 8

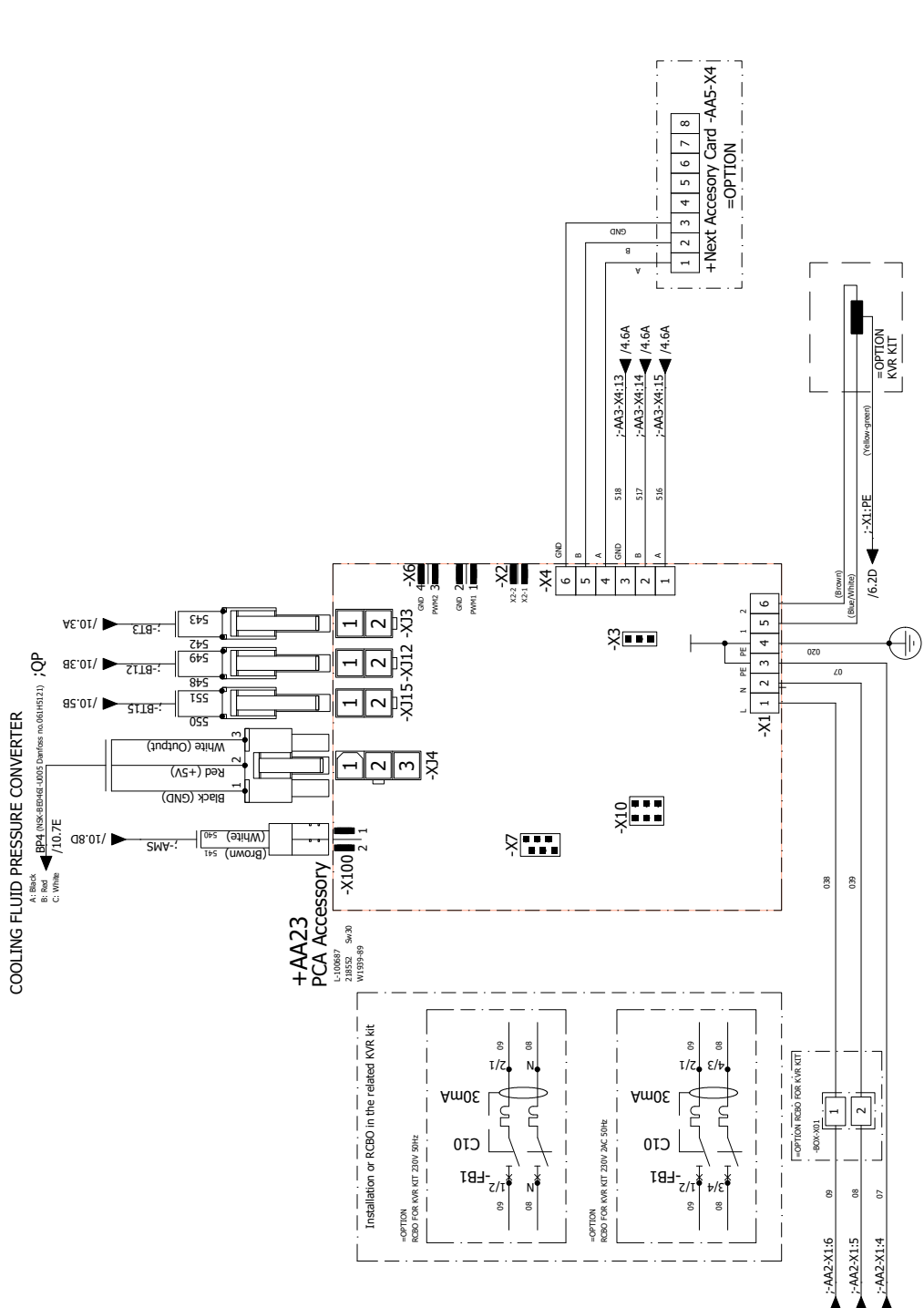

AA23 PCA Accessory		REV.	DATE	NAME	Date	Drawing no	30670
		CHANGES					
NEXT SHEET							6
SHEET							5

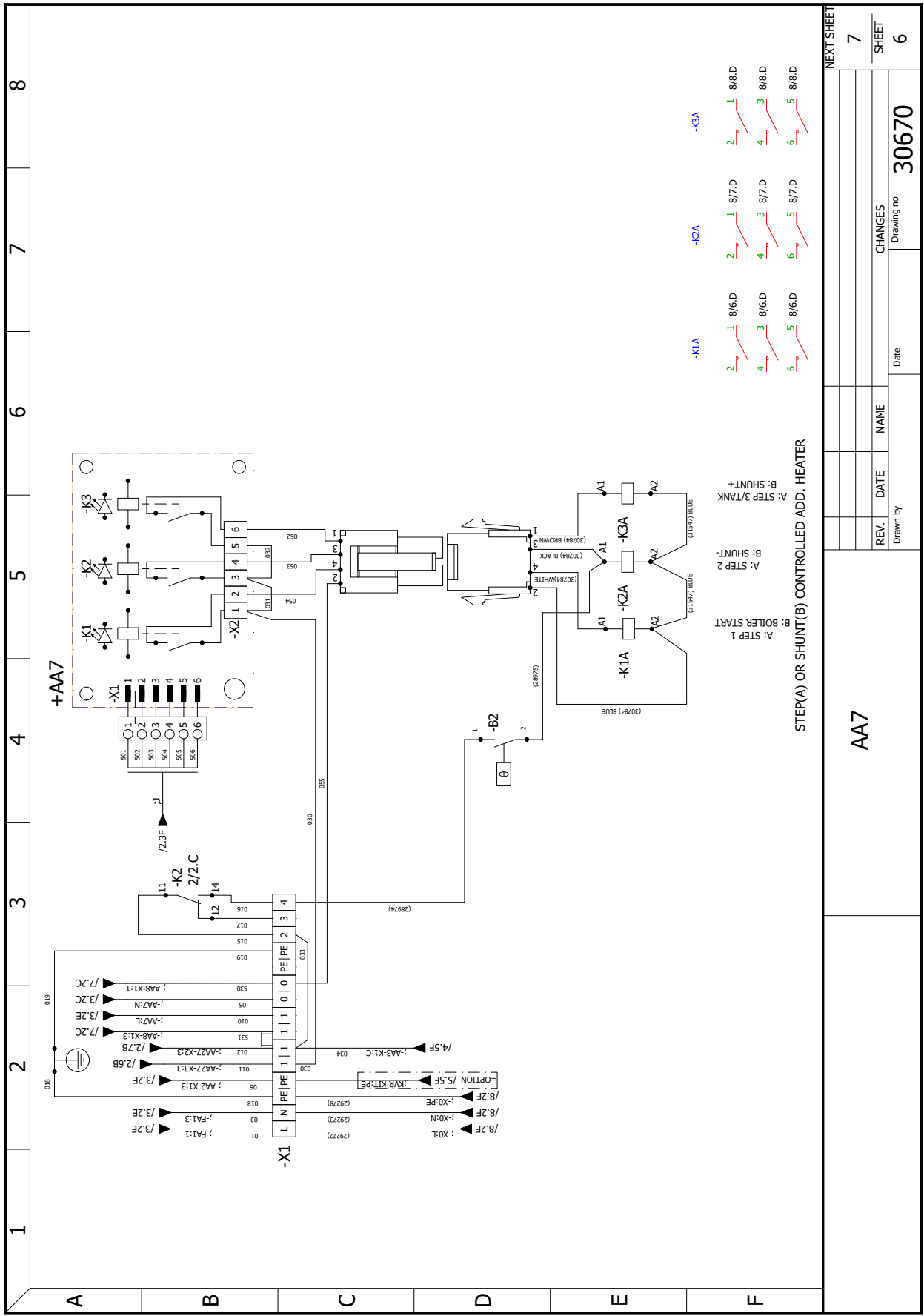

AA7		NEXT SHEET	
		7	SHEET
		6	
REV.	DATE	NAME	CHANGES
Drawn by		Drawing no	
		30670	
Date			

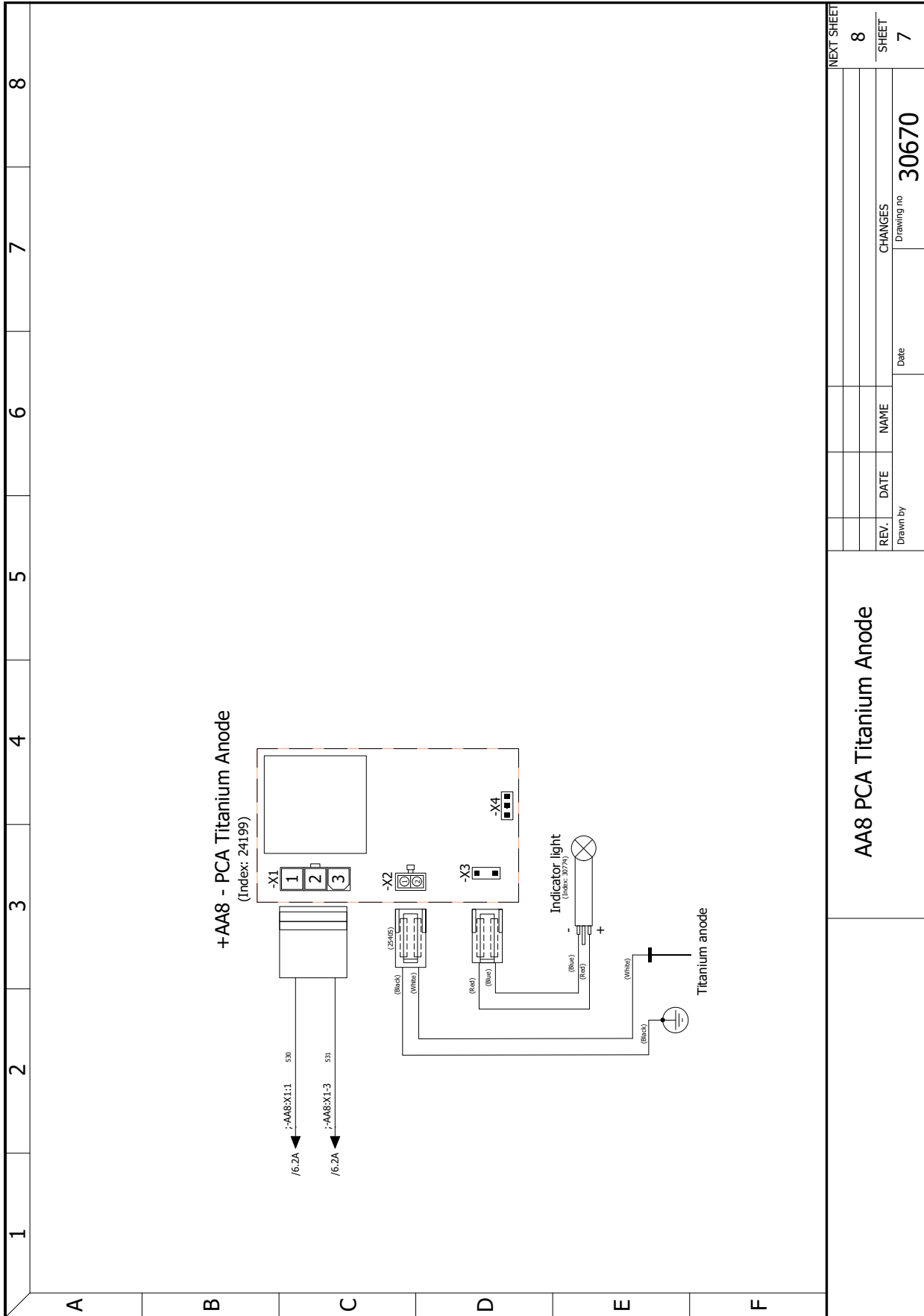

REV.	DATE	NAME	CHANGES	Drawing no
				30670
Drawn by				Date

AA8 PCA Titanium Anode				NEXT SHEET
				8
				SHEET
				7

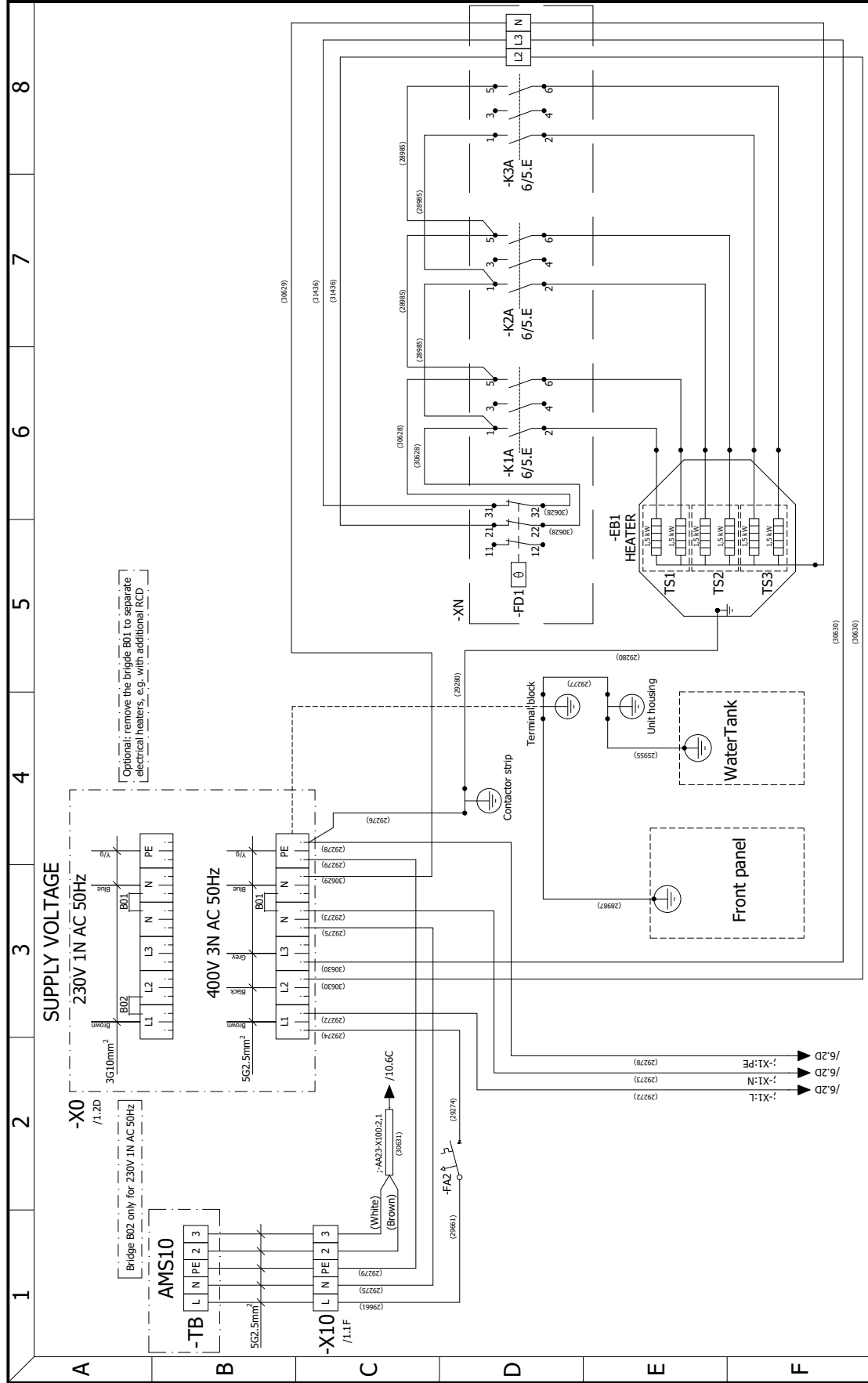

Optional: remove the bridge B01 to separate electrical heaters, e.g. with additional RCD.

NEXT SHEET			9
CHANGES			SHEET
Drawing no			30670
REV.	DATE	NAME	Date
Drawn by			

Power connection

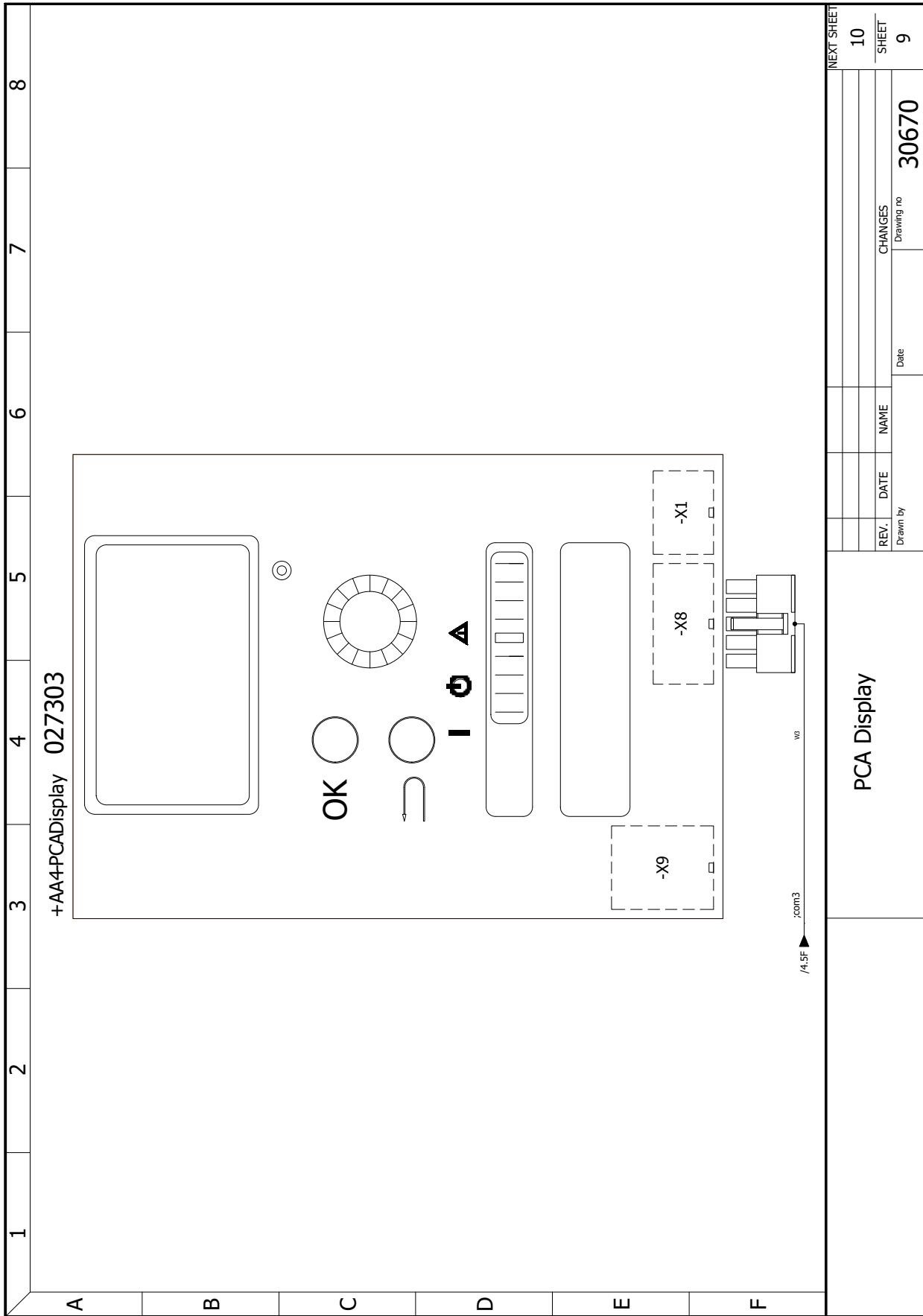

				NEXT SHEET	
				10	
				SHEET	
				9	
REV.	DATE	NAME	CHANGES	Drawing no	
				30670	
Drawn by			Date		
PCA Display					

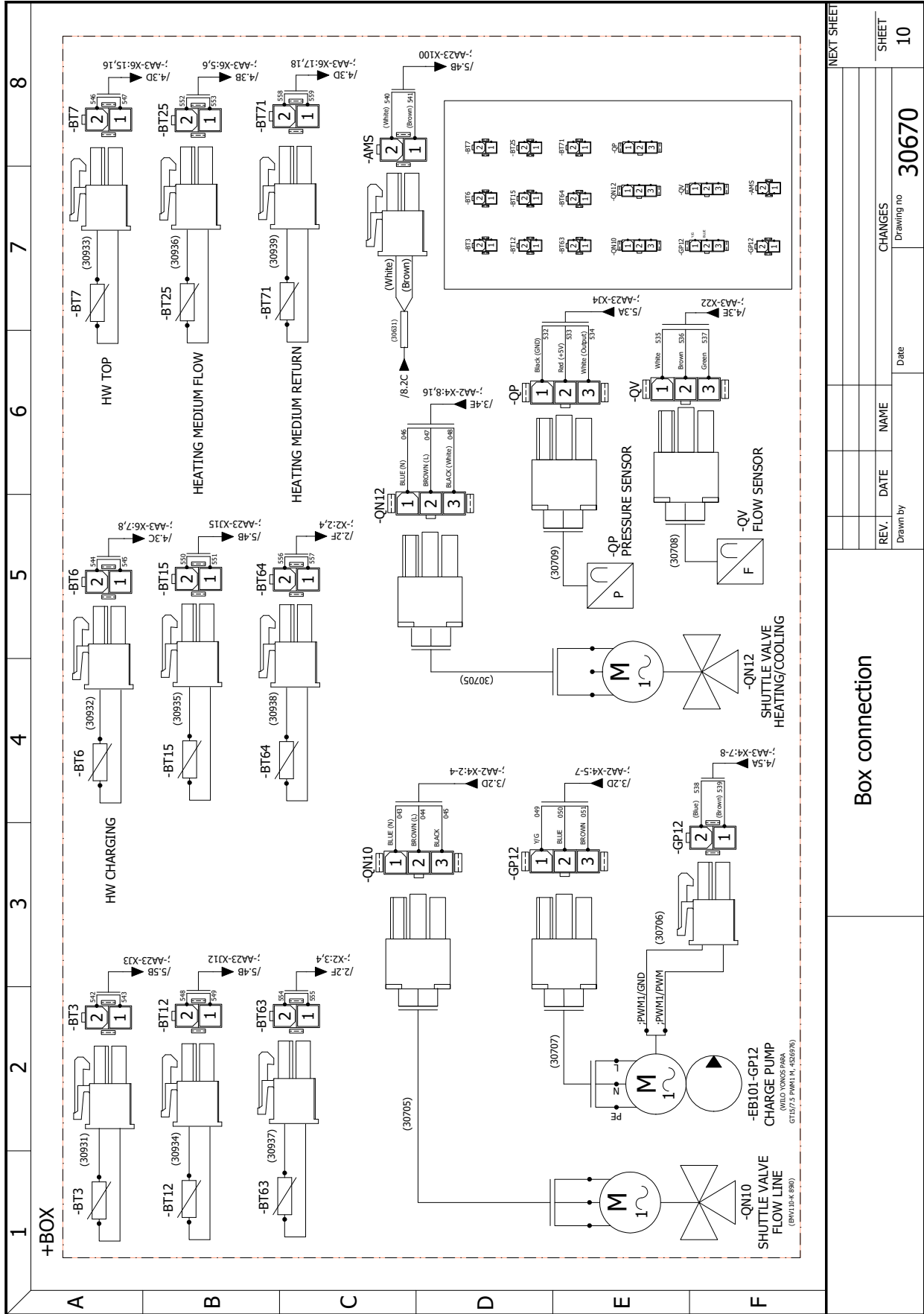

Box connection

REV.	DATE	NAME	Date

Drawn by: **30670**

CHANGES: Drawing no: **30670**

SHEET: **10**



METRO THERM A/S
RUNDINSVEJ 55
DK3200 HELSINGE
INFO@METROTHERM.DK
WWW.METROTHERM.DK

08:242-1909