

TMAX LOW VOLTAGE MOULDED-CASE CIRCUIT-BREAKERS
XT5

SACE Tmax XT

Operation and maintenance manual for Ekip Touch Trip Units



Glossary	3	Ekip Touch - Default	126
Introduction	4	1 - Ekip TOUCH default parameters.....	126
1 - Contents.....	4	Internal electronic accessories	127
2 - Safety.....	5	1 - Rating Plug.....	127
Trip unit Overview	6	2 - Measurement	128
1 - General characteristics	6	External electronic accessories	129
2 - Ekip Touch models and versions.....	7	1 - Introduction to the electronic accessories	129
3 - Accessories and software	13	2 - Ekip Cartridge.....	130
4 - Operating features	16	3 - Ekip Supply.....	131
Management operations	17	4 - Ekip Com Modbus RTU	132
1 - Putting into service.....	17	5 - Ekip Com Profibus DP.....	135
2 - Maintenance and troubleshooting	19	6 - Ekip Com DeviceNet™	138
Ekip Touch - Interface and menus	24	7 - Ekip Com Modbus TCP.....	141
1 - Presentation of interface.....	24	8 - Ekip Com Profinet.....	145
2 - Navigation	26	9 - Ekip Com EtherNet/IP™	148
3 - Graphic pages.....	28	10 - Ekip Com IEC 61850.....	151
4 - Menu.....	32	11 - Ekip Link	155
5 - Changing parameters and commands	37	12 - Ekip Com Hub	159
6 - PIN and security	39	13 - Ekip Signalling 2K.....	163
Protections	40	14 - Ekip Synchrocheck.....	167
1 - Protections - Introduction.....	40	15 - Ekip Signalling 3T	173
2 - Standard Protections.....	41	16 - Ekip CI.....	176
3 - Voltage protections.....	51	Internal accessories	179
4 - Voltage Advanced protections.....	54	1 - Ekip Com Modbus RTU.....	179
5 - Frequency protections.....	58	2 - Ekip Com Modbus TCP.....	181
6 - Power protections	61	3 - Ekip Com Profinet.....	184
7 - ROCOF protections.....	67	4 - Ekip Com EtherNet/IP™	186
8 - Protection Adaptive	68	5 - Ekip Com IEC 61850.....	189
9 - Motor protections	69	6 - Ekip Link	192
10 - Additional protections and functions.....	73	7 - Ekip Com Hub	196
11 - Logic selectivity	79	8 - Ekip Signalling 1K.....	200
12 - Performance table.....	81	9 - Ekip Maintenance.....	202
13 - Functions	84	10 - Micro I/O.....	204
Ekip Touch - Measurements	100	Other electronic accessories	205
1 - Standard Measurements	100	1 - Ekip Signalling 10K.....	205
2 - Measuring Measurements.....	104	2 - Ekip Signalling Modbus TCP	205
3 - Class 1 Power & Energy Metering.....	107	3 - Ekip Multimeter	206
4 - Datalogger	108	4 - External neutral.....	206
5 - Network Analyzer	110	5 - Testing and Programming	207
Ekip Touch - Settings	117		
1 - Main settings	117		
2 - Additional settings	122		
Ekip Touch - Test	124		
1 - Test.....	124		

Glossary

Term	Description
SACE Tmax XT5	New series of ABB SACE moulded-case circuit-breakers
CB	Circuit-breaker
Trip unit / Protection release	Electronic unit connected to the CB, which provides measuring, monitoring and protection functions for the CB if faulty operating conditions occur. In the event of an alarm, it commands a TRIP
Ekip Touch	Trip unit for SACE Tmax XT5 CB, equipped with touchscreen display and available in six different versions
Trip coil	CB opening actuator controlled directly by Trip unit
TRIP	Concluding action of protection timing or a test command which, except in special configurations applicable to the trip unit, coincides with activation of the trip coil, which instantly opens the bars of each pole and interrupts the circulating current
Vaux	Auxiliary power supply
4P / 3P / 3P + N	CB configuration: four-pole (4P), three-pole (3P) and three-pole with external neutral (3P + N)
I_f	Fault current measured by Trip unit, useful for calculating the trip time t_t

Introduction

1 - Contents

Overview This manual describes the characteristics of the Ekip Touch Trip units installed on SACE Tmax XT5 CB, among which:

1. general overview:
2. management operations: putting into service, maintenance, troubleshooting
3. operating conditions
4. consultation of menus for changing parameters and displaying measurements
5. accessories

Firmware This manual is updated to firmware version 3.12

recipients This manual refers to two user profiles, as defined by standard IEC 60050:

- skilled person, in the electrical field (IEV 195-04-01): person with relevant education, training, knowledge and experience to enable him or her to perceive risks and to avoid danger which electricity can create
- instructed person, in the electrical field (IEV 195-04-02): person adequately advised or supervised by electrically skilled persons to enable him or her to perceive risks and to avoid danger which electricity can create



IMPORTANT: operations which can be performed by persons trained on the subject of electricity are specifically indicated in this manual. All the remaining operations described in this manual must be performed by skilled persons, in the field of electricity. ABB declines all liability for damage to persons or property caused by failure to comply with the instructions in this document.

Specifications and supporting documents To ensure that Ekip Touch is installed and configured correctly, please read the information in this manual and in the technical documentation of the product, available in the website [ABB LIBRARY](#)

Document	Code	Description
Technical catalogue	1SDC210100D0201	CB SACE Tmax XT general catalogue
Wiring diagrams	1SDM000005A1001	CB SACE Tmax XT5 Wiring diagrams
Installation instructions	1SDH002011A1001 1SDH002011A1002	CB SACE Tmax XT5 Installation instructions
System Interface	1SDH002031A1002	Communication System Interface SACE Tmax XT CBs

Design notes The information in this manual was written in Italian and then translated into other languages to conform to the laws and/or commercial requirements concerning the product.

2 - Safety

Safety requirements



Figure 1



HAZARD! RISK OF ELECTRIC SHOCK! In accordance with the local laws in force, disconnect all the electricity supplies when Ekip Touch is being assembled, installed, serviced or decommissioned if persons who are not authorized to work in live installations are present.



WARNING!

- detailed descriptions of the standard installation, operation, maintenance procedures and principles for working safely are not included; it is important to note that this document contains indications about safety and caution, against certain methods (concerning installation, operation and maintenance) which could cause injuries to the personnel, damage devices or make them unsafe
- these warnings and alarms do not include all the conceivable methods of performing the installation, operation and maintenance operations recommended by ABB and others, which could be performed, or the possible consequences and complications of each conceivable method, neither will ABB investigate all those methods
- anyone who is implementing procedures or using maintenance devices recommended by ABB or not must check carefully that neither their personal safety nor the safety devices are endangered by the installation, operation, maintenance method or by the tools used; contact your nearest ABB representative for further information, explanations or specific problems
- this manual is written for qualified personnel only and is not intended to replace an adequate training course or experience concerning the safety procedures of this device
- regarding products equipped with communication systems, the purchaser, installer or end customer are responsible for applying all the IT security measures to prevent risks deriving from connection to communication networks; among others, these risks include use of the product by unauthorized persons, alteration of its normal operation, access to and modification of the information
- the purchaser, installer or end customer are responsible for ensuring that safety warnings and notices are affixed and moreover, that all points of access and operating devices are securely blocked when the switchgear is left even momentarily unattended
- all information in this document is based on the latest product data available at the time of printing. We reserve the right to make changes to the document at any time and without prior notice

Warnings



WARNING! READ THIS MANUAL WITH CARE BEFORE INSTALLING, OPERATING OR REPAIRING THE CIRCUIT-BREAKER

- file this manual with all the other available documents concerning the circuit-breaker
- to facilitate the work, these documents must be readily available when the CB is installed, operated and serviced
- the unit must be installed in accordance with the environmental, electrical and mechanical limitations described in the product documentation
- this circuit-breaker has been designed to operate with voltage and current values within the rating plate limits: do not install in systems that operate at values exceeding these rated limits
- comply with the safety procedures required by your Company.
- do not open covers or doors, do not work on devices before having disconnected all circuits from the electricity sources and after having made sure of this with a measuring instrument

Trip unit Overview

1 - General characteristics

Families SACE Tmax XT5 can be configured to operate with two Trip unit families:

- Ekip Dip with interface via DIP switches
- Ekip Touch with touchscreen display

Both families provide protection and measuring functions related to signals from the installation and are available in different models and versions.

There are six Ekip Touch models available:

- Ekip Touch
- Ekip Touch Measuring
- Ekip Hi-Touch
- Ekip G Touch
- Ekip M Touch
- Ekip G-Hi Touch

As mentioned previously, a description of Ekip Touch is given in this manual; consult the *Installation Instructions* for a description of Ekip Dip; references are given on page 4

Main functions The Ekip Touch Trip unit provides the following functions:

1. *Measurement*: measurement of different quantities, such as: current, voltage, power, energy
2. *Protection*: depending on the measurements made and the parameters configured by the user, the Trip unit checks for the presence of alarms and commands circuit-breaker opening if necessary
3. *Signalling*: management of contacts and communication networks to optimize plant efficiency, communication among different CB and other functions

The functions are provided both by transducers and actuators inside the circuit-breaker, and by means of a vast range of external accessories.

Presentation



Figure 2

Ekip Touch has a touchscreen display (1) for accessing the configuration menus and checking parameters, measurements and information (page 24).

The nominal size of the Rating plug (2) can be checked on the front (page 127) and access the battery compartment (4).

Connections to the internal and external electronic accessories are in the internal terminal box (3) (page 13 for an overview of the electronic accessories, refer to the Technical catalog and Circuit diagrams for all the other accessories).

The external connectors for zone selectivity are on the back (5) (page 73) and, with 3P CB, for the *External neutral* sensor (page 206) and for the external neutral voltage V0.

2 - Ekip Touch models and versions

Default functions and extensions

Every Ekip Touch module has default measurement and protection functions, which can be extended with the aid of additional software packages.

The extensions (additional SW packages) can be pre-engineered when the circuit-breaker is ordered or at a later date (in this case, via ABB Ability Marketplace™)

Ekip Touch



Figure 3

Ekip Touch is available in two versions: Ekip Touch LSI and Ekip Touch LSIG.

Both versions have default functions and can be configured with various different additional SW packages (extensions).

Default

Functionality	Page
Standard Protections	81
Standard Measurements	100

Additional SW packages

Functionality	Page
Voltage protections ⁽¹⁾	51
Voltage advanced protections ⁽¹⁾	54
Frequency protections ⁽¹⁾	58
Power protections ⁽¹⁾	61
ROCOF protections ⁽¹⁾	67
Adaptive protections	68
Measuring Measurements	104
Class 1 Power & Energy Metering ⁽²⁾	107
Datalogger ⁽¹⁾	108
Network Analyzer ⁽¹⁾	110

⁽¹⁾ package configurable if Measuring Measurements package is present

⁽²⁾ package only available at the time the circuit-breaker is ordered

Ekip Touch Measuring



Figure 4

Ekip Touch Measuring is available in two versions: Ekip Touch Measuring LSI and Ekip Touch Measuring LSIG.

Both versions have default functions and can be configured with various different additional SW packages (extensions).

Default

Functionality	Page
Standard Protections	81
Standard Measurements	100
Measuring Measurements	104

Additional SW packages

Functionality	Page
Voltage protections	51
Voltage advanced protections	54
Frequency protections	58
Power protections	61
ROCOF protections	67
Adaptive protections	68
Class 1 Power & Energy Metering ⁽¹⁾	107
Datalogger	108
Network Analyzer	110

⁽¹⁾ package only available at the time the circuit-breaker is ordered

Ekip Hi-Touch



Figure 5

Ekip Hi-Touch is available in two versions: Ekip Hi-Touch LSI and Ekip Hi-Touch LSI G.

Both versions have default functions and can be configured with various different additional SW packages (extensions).

Default

Functionality	Page
Standard Protections	81
Standard Measurements	100
Measuring Measurements	104
Voltage protections	51
Frequency protections	58
Power protections ⁽¹⁾	61
Adaptive protections	68
Class 1 Power & Energy Metering	107
Datalogger	108
Network Analyzer	110

Additional SW packages

Functionality	Page
Voltage Advanced protections	54
Power protections ⁽¹⁾	61
ROCOF protections	67

⁽¹⁾ Ekip Hi-Touch has certain protections of the complete package by default; the remaining protections in the package can be activated on request

Ekip M Touch



Figure 6

Ekip M Touch is available in a single version: Ekip G Touch LRIU has default functions that can be integrated by means of various different additional SW packages (extensions).

Default

Functionality	Page
Standard Protections	81
Standard Measurements	100
Measuring Measurements	104
Voltage protections	51
Frequency protections	58
Power protections ⁽¹⁾	61
Adaptive protections	68
Motor protections	69

Additional SW packages

Functionality	Page
Voltage advanced protections	54
Power protections ⁽¹⁾	61
ROCOF protections	67
Class 1 Power & Energy Metering ⁽²⁾	107
Datalogger	108
Network Analyzer	110

⁽¹⁾ Ekip M Touch has certain protections of the complete package by default; the remaining protections in the package can be activated on request

⁽²⁾ package only available at the time the circuit-breaker is ordered

Ekip G Touch



Figure 7

Ekip G Touch is available in a single version: Ekip G Touch LSIG has default functions that can be integrated by means of various different additional SW packages (extensions).

Default

Functionality	Page
Standard Protections	81
Standard Measurements	100
Measuring Measurements	104
Voltage protections ⁽¹⁾	51
Voltage advanced protections ⁽¹⁾	54
Frequency protections ⁽¹⁾	58
Power protections ⁽¹⁾	61
Datalogger	108

Additional SW packages

Functionality	Page
Voltage protections ⁽¹⁾	51
Voltage advanced protections ⁽¹⁾	54
Frequency protections ⁽¹⁾	58
Power protections ⁽¹⁾	61
ROCOF protections	67
Adaptive protections	68
Class 1 Power & Energy Metering	107
Network Analyzer	110

⁽¹⁾ Ekip G Touch has certain protections of the complete package by default; the remaining protections in the package can be activated on request

Ekip G Hi-Touch



Figure 8

Ekip G Hi-Touch is available in a single version: Ekip G Hi-Touch LSIG, and has all the functions of the Ekip Touch family by default.

Functionality	Page
Standard protections	81
Voltage protections	51
Voltage advanced protections	54
Frequency protections	58
Power protections	61
ROCOF protections	67
Adaptive protections	68
Standard Measurements	100
Measuring Measurements	104
Class 1 Power & Energy Metering	107
Datalogger	108
Network Analyzer	110

3 - Accessories and software

Internal modules Ekip Touch is always supplied with the following modules:

Name	Function	Page
Rating Plug ⁽¹⁾	Defines rated current In	127
Measurement ⁽²⁾	Measurement from installation voltage	128

⁽¹⁾ Assembled by default at the time equipment is ordered; can be replaced afterwards with a model of a different size

⁽²⁾ The functions of the module are available if the Measuring measures package is present

External accessories The functions of Ekip Touch can be expanded by further accessories and external modules, which differ as to function and assembly method.

The main external modules are:

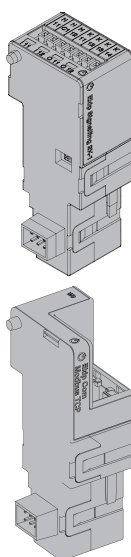

Name	Function	Page
Ekip Supply	Power supply	131
Ekip Com	Communication (with various protocols)	132
Ekip Link	Communication via intranet with ABB proprietary protocol	155
Ekip Signalling 2K	Signalling with inputs/outputs	163
Ekip Signalling 3T	Signalling with analog inputs	173
Ekip Synchrocheck	Voltage measurement and synchronism between two supply sources	167
Ekip CI	Command module for motor applications	176

These modules must always be connected to the Trip unit using the Ekip Cartridge DIN Rail accessory and only if there are no internal accessories present (page 130).

Other external modules and accessories, available with direct connections to the internal terminal box or rear connectors, are:

Name	Function	Page
Ekip Signalling 10K	Signalling with inputs/outputs	205
Ekip Multimeter	Panel front display	206
External neutral	Neutral protection with 3P CB	206

⁽¹⁾ Presence of auxiliary supply required and, for terminal box models, of Ekip Supply

In addition, the supervision, configuration and reporting functions are provided by further modules for temporary communication and supply:

Name	Function	Page
Ekip TT	Supply and tests	207
Ekip T&P	Supply, communication, programming and tests	
Ekip Programming	Supply, communication and programming	

Internal accessories The SACE XT5 circuit-breaker has a compartment for connection certain internal modules to the Trip unit:

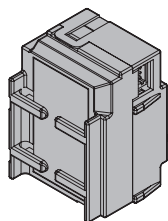

Name	Function	Page
Ekip Com	Communication (various protocols)	179
Ekip Signalling 1K	Signalling with inputs/outputs	200
Ekip Maintenance	Signalling with inputs/outputs	202
Micro I/O	CB status signaling	204

These modules connect to the Trip unit directly to the internal terminal box and only if there are no external accessories (with the exclusion of Ekip Signalling 10K, Ekip Multimeter and External neutral).

Additional functions Ekip Touch can be equipped with further software configurations compliant with different functional applications:

- Synchro reclosing

For details consult the *Technical catalog* (page 4) or the summary documents of each function.

Supporting software Different softwares and documents are available; the majority are free of charge and are designed to facilitate, optimize and extend the functions and configurations of Ekip Touch in your installation:



NOTE: some of the documents mentioned in the next table refer to SACE Emax 2, but can also be used with SACE Tmax XT5

Ekip Connect 3

ABB software to interface with Ekip Touch and other low voltage devices [\(LINK\)](#)

EPiC

ABB APP to interface with Ekip Touch using a smartphone / tablet via Bluetooth [\(LINK\)](#)

Ekip View

ABB software which supervises the communication network, analyzes the trend of the electricity values and monitors the plant conditions [\(LINK\)](#)



NOTE: the link launches the software package download, which requires about 1.3 Gb of space.

e-Design

ABB software suite [\(LINK\)](#) which includes the following tools:

- DOC, to design the single-line diagrams of low and medium voltage electrical installations, choose the operating and protection devices and check and coordinate the protections
- CAT, for technical / commercial cost estimating of ABB products
- Curves, for drawing, calibrating and printing the trip curves of the protection devices
- OTC, for assessing the thermal behavior of the switchgear and sizing its fans and air conditioners
- UniSec, for configuring medium voltage switchgear

Front CAD

Software comprising libraries of block graphics for ABB panel-making products to be used with the latest versions of AutoCAD, AutoCAD LT, IntelliCAD [\(LINK\)](#)



NOTE: the link launches the software package download, which requires about 190 MB of space.

Slide Rules

App for sizing low voltage electrical cables according to the installation methods specified by current regulations and installation practices.

Further information on the documentation is available on the Apple Store, in particular: [SLIDE RULES](#).

Further documents

Catalogue IEC

Tmax XT general catalogue IEC ([1SDC210100D0204](#))

Technical characteristics IEC

Tmax XT Technical characteristics IEC ([1SDC210099D0204](#))

Catalogue UL

Tmax XT general catalogue UL ([1SDC210200D0204](#))

Technical characteristics UL

Tmax XT Technical characteristics IEC ([1SDC210199D0204](#))

Product notes for Network Analyzer

Introduction to the *Network Analyzer* measuring and analysis system ([1SDC210106D0201](#))

Product notes for Motor Protection

Main features for motor protection ([1SDC210112D0201](#))

Handbook

General overview of electrical installations ([1SDC010002D0206](#))

Communication functions through Ekip architecture

Overview of communication functions using Ekip architecture ([1SDC210101D0201](#))

Protection against electric arc

General characteristics for arc protection ([1SDC210104D0201](#))

Generator protection for low-voltage applications

General characteristics for the protection of generators for low voltage applications ([1SDC210108D0201](#))

Ekip Signalling 3T Temperature monitoring module

General features of Ekip Signalling 3T module ([1SDC210109D0201](#))

How to tackle Cyber Security

General overview of how to deal with Cyber Security ([1SDC210111D0201](#))

4 - Operating features

Introduction Ekip Touch has been developed and certified to function in specific environmental, electrical and mechanical conditions; full details are available in the *Technical catalog* (page 4).

The following sections describe the electrical and power supply characteristics that enable Trip unit and the relative electronic accessories to operate correctly.

Electrical characteristics The Ekip Touch measurement and protection functions described in this document are provided with primary voltage and current values within the following nominal ranges:

Parameter	Operating limits
Primary current (line-to-line)	$0,004 \div 16 I_n^{(1)}$
Primary voltage (line-to-line)	$0 \div 690 \text{ V AC}$
Rated frequency	45 ... 55 Hz (with $f_n = 50 \text{ Hz}$) / 54 ... 66 Hz (with $f_n = 60 \text{ Hz}$)
Peak factor	Complying with standard IEC 60947-2

⁽¹⁾ based on each phase; I_n refers to the nominal size defined by the Rating plug installed on the Trip unit, available in models from 250 A to 400 A for CB with $I_u = 400 \text{ A}$ and from 250 A to 630 A for CB with $I_u = 630 \text{ A}$

Ekip Touch can self-supply itself directly from the internal current sensors:

Parameter	Operating limits
Minimum three-phase turn-on current	$> 0,2 I_n$

Auxiliary power supply Ekip Touch can be connected to an external auxiliary supply source, which is useful when certain functions such as communication via Local Bus, recording manual operations, certain measurements and the datalogger must if available.

The auxiliary supply can be provided by modules from the *Ekip Supply* range (further details about operation are given on page 131) or by direct connection to the internal terminal box.

Direct connection must guarantee the following operating conditions:

Parameter	Operating limits
Voltage	24 V DC galvanically isolated
Tolerance	$\pm 10\%$
Maximum ripple	$\pm 5\%$
Maximum inrush current @ 24 V	10 A per 5 ms
Maximum rated power @ 24 V	4 W
Connection cable	Insulated with grounding cable (same characteristics as Belden 3105A/B or higher)



IMPORTANT: if connection is direct, the power supply must be galvanically insulated and provide the insulation characteristics established by standard IEC 60950 (UL 1950) or equivalent.

Management operations

Life cycle The following operations are required to ensure that SACE Tmax XT functions correctly:

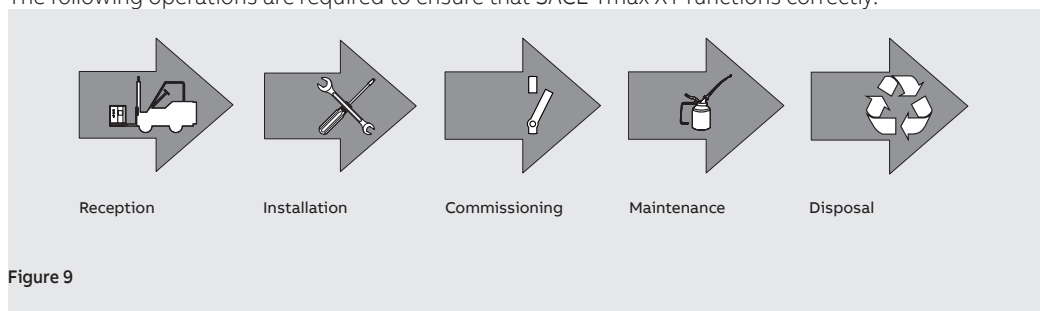

Operation	Description
Reception	Unpacking and inspection of materials received
Installation	Assembly operations
Putting into service	General pre-ignition inspections
Maintenance and faults	Routine inspections and cleaning, management of alarms or faults
Decommissioning	EOL treatment and disposal

This document describes the *Putting into service* and *Maintenance and faults* operations for Ekip Touch; consult the *Installation Instructions* and *Technical catalog* for the other operations (references on page 4).

1 - Putting into service

Wizard When powered up, Ekip UP displays the Wizard window, a user-friendly procedure for immediate adjustment of certain parameters: language, date, time, voltage of the installation, PIN (and RELT Wizard if RELT - Ekip Signalling 2K-3 module is present).

After the procedure has terminated, the window will no longer appear unless it is reset via Ekip Connect by the **Reset Wizard** command: in this case, Wizard will appear when the apparatus is powered up the next time.



NOTE: for security reasons, ABB strongly advises you to change the PIN right from the first access and to keep it in a safe place

General checks Perform the following inspections before putting into service:

Points to be checked	Checks
Main connections	Earth connections
	If present, connection and tightening to external voltage tap offs (V0)
	If present, connection of <i>Ekip Supply</i> supply/module
Alarm	If Ekip Touch is not on, connect an external supply device (example: <i>Ekip TT</i>) to the Trip unit and make sure there are no alarms present (details on page 19).
Parameters	Configure all the parameters of the unit as required

Check accessories The inspections to perform on the external and internal accessories, if present, before putting into service are indicated below:

Accessories	Checks
External modules	1. If <i>Ekip Cartridge</i> is present: check the connections of all modules to <i>Ekip Supply</i> and the connection between <i>Ekip Cartridge</i> and the lateral terminal box of the CB For <i>Ekip Signalling 10K</i> and <i>Ekip Multimeter</i> , in the absence of <i>Ekip Cartridge</i> : check the connection of the bus of the module (W3-W4) to the lateral terminal box of the CB
	2. Power up <i>Ekip Touch</i> (and the external modules if there is a separate supply) and make sure they are on
	3. Check that the Local bus is enabled (<i>Settings-Modules-Local Bus</i>)
	4. Check that the Power Led of each module is on like the Power Led of <i>Ekip Touch</i> (steady or synchronous flash)
	5. Check in the <i>About-Modules</i> menu to make sure that all installed modules are present and that there are no alarms
Internal modules	1. make sure that module is connected to the internal terminal box
	2. Make sure that the auxiliary supply is connected to the internal terminal box
	3. Power up the Trip unit and make sure it is on
	4. Check in the <i>About-Modules</i> menu to make sure that all installed modules are present and that there are no alarms
External neutral	1. Check that the sensor is connected to the lateral terminal box of the CB in the proper way and that the terminals are in the right direction ⁽¹⁾
	2. Power up the Trip unit and make sure it is on
	3. Check in the <i>Settings-Circuit-breaker</i> menu that <i>Configuration= 3P + N</i> ; otherwise change the parameter
	4. Make sure there are no alarms
Zone selectivity	1. Check selectivity connections (between <i>Ekip Touch</i> and the other units) as shown in circuit diagrams 1SDM000002A1001
	2. Provide <i>Ekip Touch</i> with auxiliary power and make sure that CB status is: Open
	3. Check that the protection of the selectivity concerned has been enabled (example: S protection)
	4. Select the <i>Zone Selectivity</i> menu and the submenu of the protection concerned; follow the instructions in points 5, 6, 7 and 8 for each protection activated
	 NOTE: for selectivity D, consider submenu S for the Forward connections and G for the Backward connections
	Check Output:
	5. Select the <i>Force Output</i> command and check, on the Trip unit connected to the <i>Ekip Touch</i> output, that the status of its <i>Input = ON</i>
	6. Select the <i>Release Output</i> command and check, on the Trip unit connected to the <i>Ekip Touch</i> output, that the status of its <i>Input = OFF</i>
Check Input:	
7. Select the <i>Force Output</i> command on the Trip unit connected to the <i>Ekip Touch</i> input and check on <i>Ekip Touch</i> that the status of its <i>Input = ON</i>	
8. Select the <i>Release Output</i> command on the Trip unit connected to the <i>Ekip Touch</i> input and check on <i>Ekip Touch</i> that the status of its <i>Input = OFF</i>	
MOE-E stored energy operating mechanism	1. Make sure that the <i>MOE-E</i> stored energy operating mechanism is correctly cabled as shown in circuit diagrams 1SDM000002A1001
	2. Set the circuit-breaker to the closed position
	3. Provide <i>Ekip Touch</i> with auxiliary power and supply the <i>MOE-E</i> device with rated voltage
	4. Perform an opening test from the <i>Test-Test CB</i> menu with the <i>Open CB</i> command and check that the CB has opened
	5. Repeat the test from the <i>Test-Test CB</i> menu with the <i>Close CB</i> command and check that the CB has closed
AUP circuit breaker status inputs, if CB is withdrawable version	1. Check that Trip unit reads status of withdrawable circuit breaker properly by means of <i>About-Circuit breaker-CB Status</i>
	2. Switch status of <i>AUP</i> device and make sure that Trip unit reads the status change properly by means of <i>About-Circuit breaker-CB status</i> menu

⁽¹⁾ for details consult document [1SDH001000R0506](#)

2 - Maintenance and troubleshooting

Introduction Correct maintenance of the unit and connected devices ensures they operate correctly over time. The maintenance operations must be performed by expert personnel, as required by the safety regulations and maintenance schedule (see recipients, Safety requirements and Maintenance schedule). If faults are discovered, find out what is causing them and eliminate them before putting the unit back into service.



WARNING! Detecting faults must only be managed by (electrically) skilled persons (IEV 195-04-01: person with relevant education and experience to enable him or her to perceive risks and to avoid hazards which electricity can create), as it may be necessary to perform insulation and dielectric tests on part or all the installation

Inspections and general cleaning Perform the following inspections:

- check to make sure that Ekip Touch is clean. Remove any dust and traces of other materials with a clean, dry cloth (use a mild detergent if necessary; a laminate thinner such as Henkel 273471 or Chemma 18 or equivalent can be used if there is a heavy coating of dirt)
- check that there are no foreign objects near the connectors or terminals

Inspection of Ekip Touch Perform the inspections described in chapter 1 - Putting into service, including an inspection of the state or the wiring, modules and accessories:

- verification of alarms
- check that the modules (internal and external modules) are present and connected
- check zone selectivity connections
- check the MOE-E stored energy operating mechanism
- check the circuit breaker status by means of AUP if the CB is a withdrawable version



NOTE: the limitations and notes given for each point in the respective paragraphs are applicable

Maintenance schedule The frequency with which Ekip Touch maintenance is scheduled differs, depending on the conditions in the installation site:

	Standard environments	Dusty environments (level of dust measured > 1 mg / m3)
Frequency of maintenance	One year or 2000 operations or after tripping due to short circuit	Every six months or 1000 operations or after a short-circuit trip

By activating and using Predictive Maintenance in ABB Ability (EDCS) on the specific switch, you can suggest a different maintenance frequency. ([LINK](#)).

Alarms displayed and suggestions A list of faults that may appear on the Ekip Touch display is given below along with suggestions on how to resolve them:

Signal	Suggestions
Numerical alarm (e.g. 30002)	Internal error; contact ABB if this type of error occurs
Battery low	Change the battery (See 1SDH001000R0509 kit sheet)
Local bus	Unit on with auxiliary supply, Local Bus parameter enabled but connection to modules not present, incorrect or communication lost (for more than five seconds); check: <ul style="list-style-type: none"> • connection and powering of modules in terminal box or external • that the modules connected are compatible with Ekip Touch

Continued on the next page

Signal	Suggestions
Trip fail command (BF)	CB has failed to open and/or current still present after a TRIP command: comply with the procedure proposed in the next chapter 'Faults, causes and remedies'
Configuration	Check: <ul style="list-style-type: none"> • <i>Rating plug</i> of model compatible with Ekip Touch and CB size • If present, protection parameters do not conflict with size of current of unit details on page 40) • In the absence of <i>Vaux</i> threshold I4 and/or I41 > 100 A • In the absence of <i>Vaux</i> time t4 and/or t41 > 100 ms
Invalid Date	Wrong date and time: set in <i>Settings-System-Date</i> and <i>Settings-System-Time</i>
Ekip CI	Ekip CI module not detected or absent, with Ekip M Touch and Open Mode configuration = Normal
Ekip Com Hub	Problem of Ekip Com Hub module with: certificates, connected devices, missing Com modules (RTU or with Ethernet connection), API TLS device, Hub events, parser configuration
Ekip Link Bus	Fault in <i>Ekip Link</i> module: check for loss of connection with one or more actors (modules) connected to Link Bus
Ekip Sign 3T connection	Alarm for connection of one or more analog inputs to <i>Ekip Signalling 3T</i> module
Ekip Sign 3T threshold	One or more thresholds of the <i>Ekip Signalling 3T</i> module has/have been exceeded
Internal error	Internal error; contact ABB if this type of error occurs
SNTP error	Fault with <i>Ekip Com</i> modules: synchronization problem of SNTP synchronization reference module
Ethernet disconnected	No external cable on one or more <i>Ekip Com</i> modules with Ethernet connection
IEEE 1588 synch	Synchronization problem of IEEE 1588 synchronization reference module
MAC Address	<i>Ekip Com</i> module detected with incorrect / not allowed MAC address, contact ABB.
Measuring installation	Install <i>Measurement</i> module (<i>Settings-Circuit breaker-Installation-Measuring-Install</i>) menu
RatingPlugInstallation	Install Rating Plug (<i>Settings-Circuit breaker-Rating Plug-Install</i> menu) and check connection if there are further faults
Maintenance	Maintenance alarm: carry out maintenance and then reset the alarm via Ekip Connect (see page 103)
Rating plug	<i>Rating plug</i> not present, value or size incompatible with Ekip Touch parameters
Zone Selectivity Diag	Error in zone selectivity connections (Hardware Selectivity)
Sensor L1/L2/L3/Ne	Fault in connection of sensors to Trip unit; check status of sensors, including external Neutral, or call ABB
Configuration Session	TFTP server enabled and/or configuration session open on module <i>Ekip Com IEC61850</i> or <i>Ekip Hub</i>
CB status	CB state incorrect (example: current present but CB in open state)
Switchboard Actor communication Error	Check configuration and connection of <i>Ekip Link</i> module
TC disconnected	Check Trip coil, status of the terminal and cables connecting to Ekip Touch
Contact Wear	Make sure that the contacts/poles are in good condition.

Continued on the next page

Protections

In the event of protection or measurement alarms, the associated signals are reported:

Signal	Type of alarm
Trip Test	Trip test performed signal. Press iTEST to reset the message
Protection timing (for example: L timing)	Specific protection in time delay mode
Protection prealarm (for example: Prealarm G)	Specific protection in prealarm
Protection (Trip off) [for example: S (Trip off)]	Specific protection, configured with trip disabled, in alarm state
2I Protection Active	2I Protection active
Load LC1 / Load LC2	Current threshold 1 I1 / 2 I1 exceeded and in alarm state
Iw1 Warning / Iw2 Warning	Current threshold Iw1 / Iw2 exceeded and in alarm state
Harmonic dist.	Harmonic Distortion protection in alarm state
Power factor	Power factor measurement ($\cos \varphi$) less than set threshold
Phase cycle	Phase sequence protection in alarm state
Frequency	Frequency measured off range (<30 Hz or >80 Hz)
5th harmonic above Th / I sopra Th / THD I above Th / THD V above Th	Single or total harmonic measurement above threshold

Faults, causes and remedies

A list of possible faulty situations for Ekip Touch, their possible causes and suggestions about how to resolve them are given below.



NOTE: check error messages on display before consulting the table; if the suggestions given fail to resolve the problem, call the ABB assistance service and provide the report produced by the Ekip Connect software if possible

Fault	Possible causes	Suggestions
Communication problems with modules in terminal box	Circuit-breaker in withdrawn position, Vaux absent or modules not inserted properly	Insert modules, set CB to Connected position, connect Vaux
CB status not aligned with CB position	Absence of terminal box modules or of contact S75I	Check for presence of terminal box modules and connect contact S75/I
Circuit-breaker fails to react to opening/closing command from Ekip Touch	The connections or supplies of the opening/closing actuators are not correct	Check connections and supplies.
	Absence of auxiliary power supply to Ekip Touch	Check supplies and status of Power LEDs
	Circuit-breaker is in a condition which fails to enable the selected command	Check circuit-breaker documentation and cases that fail to enable command
Display off and/or not backlit	No auxiliary supply or currents lower than minimum turn-on values	Correct operating condition.
	Temperature outside range	Correct operating condition.
Measurements incorrect or absent (current, voltage, etc)	Current below the minimum threshold that can be displayed	Correct operating condition.
	Incorrect frequency setting	Set frequency
	Harmonic distortion and/or crest factor off range	Correct operating condition.
	Rated Voltage parameter setting error	Set the correct parameters

Continued on the next page

Fault	Possible causes	Suggestions
The PIN is not required	The PIN has been disabled or has already been entered in the same programming session	Operating condition correct; consult chapter relating to the PIN
PIN error	PIN wrong or lost	Contact ABB or consult document 1SDH001501R0001
It is not possible to perform the trip test	Trip coil is not connected properly	Check Trip coil connection and messages on display
	CB trip signal has not been reset	Press the reset pushbutton
	The busbar current is greater than zero	Correct operating condition.
TRIP fail signaling: <i>Trip Fail command (BF)</i>	<p>One or more of the following conditions:</p> <ul style="list-style-type: none"> • Trip coil not working • status contacts not working • faulty internal wiring 	<p>1. If closed, open CB in the manual mode and check changed status.</p> <p>2. Press iTest, check that the signal has disappeared from the display and the general status of the alarms.</p> <p>3. Check the conditions of the wiring and internal contacts</p> <p>4. Working in safety conditions, close the CB and perform a trip test via the trip unit</p> <p>Contact ABB if problems persist</p>
The expected trip does not occur	Trip excluded	Operating condition correct; enable trip if necessary
Trip times different than expected	Wrong threshold/time/curve selected	Correct parameters
	Thermal memory enabled	Disable it if it is not necessary
	Zone selectivity enabled	Disable it if it is not necessary
	Incorrect neutral selection	Modify the neutral selection
Rapid trip with I3=Off	Inst trip	Correct operating condition with short circuit at high current
High ground-fault current, but no trip occurs	Incorrect selection of the sensor	Set internal or external sensor
	Function G inhibited owing to high current	Operating condition correct (see protection description chapter)
Opening data not displayed	No auxiliary power supply and/or battery low	Correct operating condition.

Programming errors

If during the programming of the parameters an attempt is made to violate certain limitations, the trip unit blocks the saving procedure and signals the error:

Type of error	Error description
30006	Parameter change not completed on display within five minutes
30007	Attempt at remote control with Trip unit configuration in the local mode
30008	Attempt at local control with Trip unit configuration in the remote mode
30011	Error in Ekip Link list of actors
30012	More than one Time Sync source (IEEE 1588 or SNTP) on one single module or between different modules
30013	Network Analyzer parameter control unsuccessful
Active Power Fail	Threshold P23 (protection UP) \geq Threshold P26 (protection OP)
DLog not stopped	Modification of datalogger parameters not allowed with datalogger function not stopped
D Th \geq I Th	Threshold I7 (protection D) \geq Threshold I3 (protection I)
Zone Sel Config = On while S / S2 / I / G = On	Zone selectivity enabling of protection D not allowed with zone selectivity already active for one among protections S, S2, I or G
G FT time = 50 ms is not valid	Trip time I4 (protection G) = 50 ms
Gext FT time = 50 ms isn't valid	Trip time I41 (protection G) = 50 ms
High priority alarm	Modification of parameters not allowed during protection times
I and MCR enabled together	Protections I and MCR are mutually exclusive
L Th \geq S Th	Threshold I1 (protection L) \geq Threshold I2 (protection S)
L Th \geq S2 Th	Threshold I1 (protection L) \geq Threshold I5 (protection S2)
L Th > 980 A	Threshold I1 (protection I) > 980 A with CB in standard configuration UL
Neutral configuration error	Configuration of neutral protection must conform to formula: $I1 (A) \geq Iu (A) \times Ne \text{ config} / 100$
OV Threshold > 828 V	Threshold U9 (Protection OV) > 828 V (690 x1.2)
RC toroid error	Activation of toroid Rc is not allowed without the presence of a model Rc rating plug
RQ Q24 \geq Q25	Threshold Q24 \geq Threshold Q25 (Protection RQ)
S Th \geq I Th	Threshold I2 (Protection S) \geq Threshold I3 (Protection I)
S2 Th \geq I Th	Threshold I5 (Protection S2) \geq Threshold I3 (Protection I)
S Time > 400 ms	Trip time t2 (protection S) > 400 ms with CB in standard configuration UL
S2 Time > 400 ms	Trip time t5 (protection S2) > 400 ms with CB in standard configuration UL
S(V) or S2(V) parameters	Error in configuration of parameters of protection S (V) or S2 (V); consult user manual of Trip unit for the limits
SYNCHRO parameters error	Inconsistency of Synchrocheck protection parameters: $\Delta \text{ phase} \geq 180 \times \Delta \text{ freq} \times [\text{minimum correspondence time} + 0.0023]$
V DIR Th > 690*1.2	Protection threshold VDIR > 828 V (690 x1.2)
VS Th > 690*1.2	One of the two thresholds of protection VS Warning > 828 V (690 x1.2)

Ekip Touch - Interface and menus

1 - Presentation of interface

- Functions** The Ekip Touch operator interface allows you to:
- display signals and measurements of the functions in progress or recorded events
 - configure the parameters, the protections present and other functions of the unit
 - set parameters concerning the accessory modules connected
 - perform tests

Components The Ekip Touch interface includes a touchscreen, short-cut push-buttons, status leds and a service connector for certain external accessories:



Figure 10



Pos.	Description
A	Single-touch color touchscreen display
B	Power led
C	Warning led
D	Alarm led
E	HOME push-button
F	iTEST push-button
G	Service connector

Display The touchscreen display of Ekip Touch is the single-touch, color type.
The touchscreen function is active when the unit is on.



LEDs





LEDs	Colour	Description
 Power Green	Green	Indicates the on status of Ekip Touch: <ul style="list-style-type: none"> • off: no power and unit off • on, steady (<i>Power mode</i>) or flashing (<i>Alive mode</i>): unit on and self-supplied by external <i>Vaux</i> or service connector The <i>Power mode</i> or <i>Alive mode</i> can be selected via Ekip Connect: if the <i>Alive mode</i> has been selected and external modules are connected, the Power leds of Ekip Touch and the modules flash in the synchronized mode. More details are given in the chapter on Ekip Connect additional functions on page 123
 Warnings Yellow	Yellow	Signals that certain alarms are present: <ul style="list-style-type: none"> • off: no alarm • on steady: prealarm of an active protection or status contacts error • two fast flashes every 0.5 s: trip unit parameter configuration error • fast flash: <i>Rating Plug</i> or <i>Measurement</i> module installation error
 Alarm Red	Red	Signals that an alarm is present: <ul style="list-style-type: none"> • off: no alarm • on steady: on steady signals a TRIP due to a protection • two fast flashes every 2 seconds: <i>Rating Plug</i> error • on with fast flashing: protection timing tripped or alarm due to disconnection of a current sensor

If on and flashing at the same time, the Warning and Alarm leds signal an alarm caused by a hardware error inside the Trip unit.

This case requires assistance from ABB.

Push-buttons



Push-button	Description
 HOME	Allows different areas of the menu to be accessed: <ul style="list-style-type: none"> • from pages: <i>HOME</i>, <i>Histograms</i>, <i>Measuring instruments</i>, <i>Measurements</i>, <i>Main measurements</i> -> open: <i>Main page</i> • from pages: <i>Main page</i>, <i>Alarm list</i>, at any point of the menu area -> open: <i>HOME</i> page
 iTEST	Allows certain pages of information about the unit to be rapidly consulted; press the button in succession to display the following pages: <ul style="list-style-type: none"> • <i>Alarm list</i>, if messages are present • <i>Info</i>, if Customer Page option is active (page 123) • <i>Protection unit</i>, with information about Ekip Touch • <i>Circuit breaker</i>, with information about the CB • <i>Last trip</i>, with information about the last trip, if available Consultation is active from pages: <i>HOME</i> , <i>Histograms</i> , <i>Measuring instruments</i> , <i>Measurements</i> , <i>Main measurements</i> <p>NOTE: with <i>Ekip Touch</i> off and the internal battery charged, press iTEST to temporarily switch on the Power led and, in the case of a trip, the display with information about the trip protection and the Alarm led</p>

Service connector



The service connector enables Ekip Touch to be connected to *Ekip TT*, *Ekip T&P* and *Ekip Programming*, allowing the unit to be temporarily supplied, parameter configuration prior to putting into service, tests and extension of the configuration functions.

IMPORTANT: only use cables supplied by ABB or with ABB accessories

2 - Navigation

Levels and pages The Ekip Touch menu is divided into several levels, all accessible using the touchscreen display and buttons available in the units:

Level 1 (HOME)

Page shown on power up; appears when push-button of the same name appears, as described on page 25; from here you can:

1. access the *MAIN PAGE* (level 2), by pressing the **HOME** button
2. access the *Alarm list*, by selecting the diagnostic bar at the bottom
3. access the *Summary pages* of some of the measurements by pressing on the edges

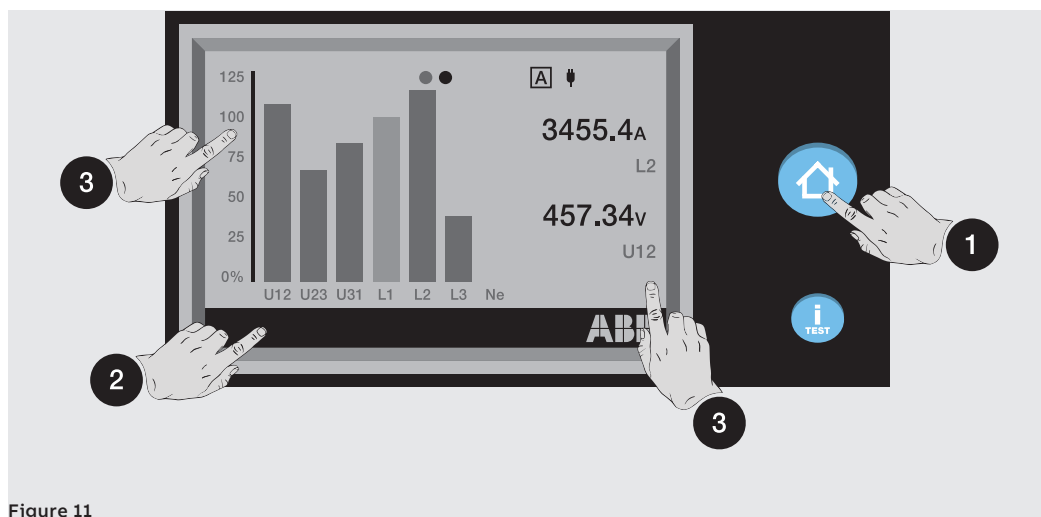

Figure 11



NOTE: Ekip Touch is supplied with the **Histograms** page configured as **HOME**; if the configuration is different, the **Histograms** can be set as the main page by pressing and holding the **HOME** key for five seconds and confirming the message on the display

Level 2 (MAIN PAGE)

This page allows you to:

4. access one of the graphic pages: *Histograms*, *Measuring instruments* and *Measurements*
5. access the **MENU AREA** (level 3)



Figure 12

Continued on the next page

Level 3 (MENU AREA):

You can access all the configuration menus and consult the parameters in this page

6. Protections and Advanced
7. Measures
8. Settings
9. Test
10. About

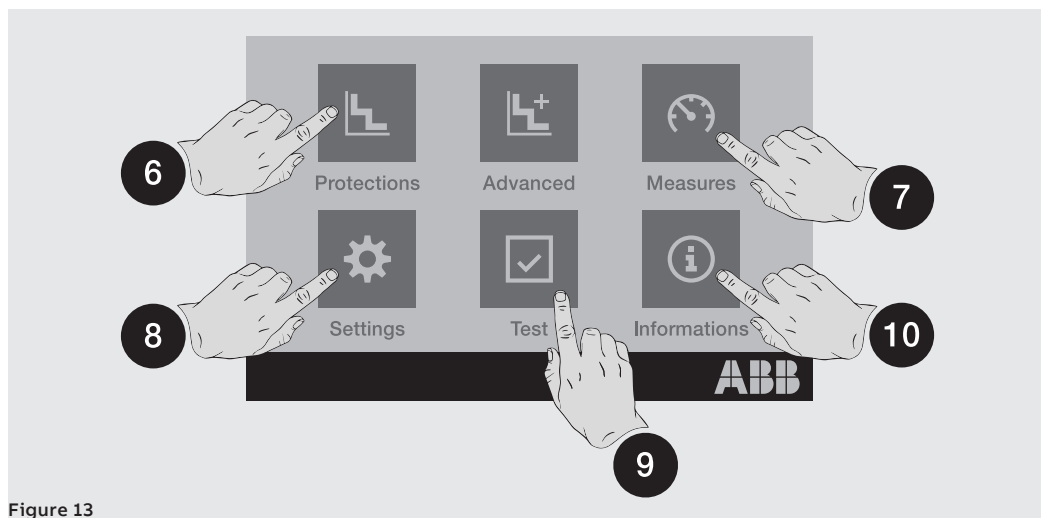

Figure 13

Level 4 (MENUS and SUBMENUS)

Selection of one of the level 3 menus accesses a set of submenus with the list of available options, which are organized into several levels through to details of the specific parameter.

Each submenu has a command for returning to the previous menu (11); if the list contains more than five options, there is also a scroll bar (12) for full consultation.

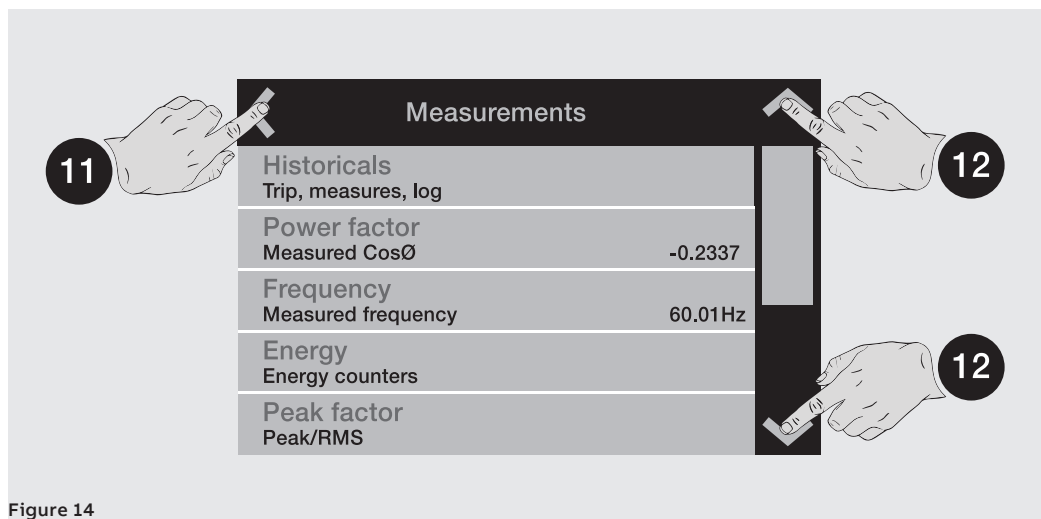

Figure 14

To consult a parameter, it just needs to be selected.

Consult the dedicated section for instructions on how to configure and save the parameters (page 37).

3 - Graphic pages

Histograms The page displays the histograms of the current and voltage measurements acquired in real time and certain status information:

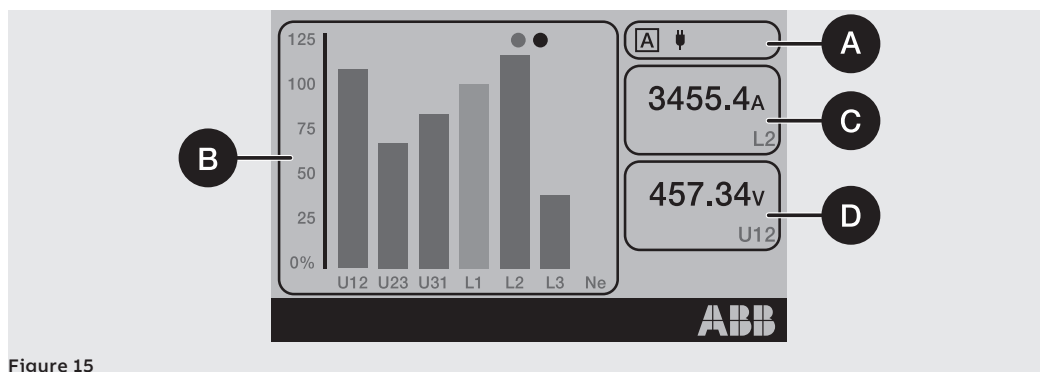











Figure 15

Pos.	Description
	Up to four information icons are available:
A	 The letter corresponding to the active configuration is displayed if <i>Adaptive Protections</i> package is present and with <i>Dual Set enabled</i> ; more details on page 68
	 External power supply present (<i>Vaux</i> or through a service connector); the plug icon indicates <i>Vaux</i>
	 Remote parameter writing configuration active, modules <i>Ekip Com</i> connected, <i>Vaux</i> present
	 Bluetooth antenna state; four options available, see next chapter for details
	 Datalogger active
B	<p>Histograms of the voltage and current measurements acquired in real time. The bar of each signal is represented in scale 0 to 125 % with reference to the rated current and voltage values of the, and can be of three colors:</p> <ul style="list-style-type: none"> • light blue: no protection in alarm status • yellow: one of the tripped protections is in prealarm status with respect to set thresholds • red: one of the tripped protections is in alarm status with respect to set thresholds <p> NOTE: <i>Histogram Ne is available with 4P or 3P + N configurations</i></p>
C	Maximum phase current measured in real time
D	Maximum line-to-line voltage measured in real time

The Bluetooth icon changes, depending on the state of the antenna and the wireless communication:

Icon	Description
	Antenna off or being powered (approx. two seconds from being enabled via the menu)
	Antenna on but no device connected
	Pairing in progress (Pairing command executed via menu)
	External device connected to Trip unit

Summary page Press on the sides of the display (1) from the Home page to access further summary pages for certain measurements:

- *Main measurements* page: maximum phase current, maximum line-to-line voltage, power factor, total active/reactive/apparent powers
- *Ekip Synchrocheck main measurements* page (when module is present): Int and Ext frequencies and voltages, phase difference, synchronism status (page 34)

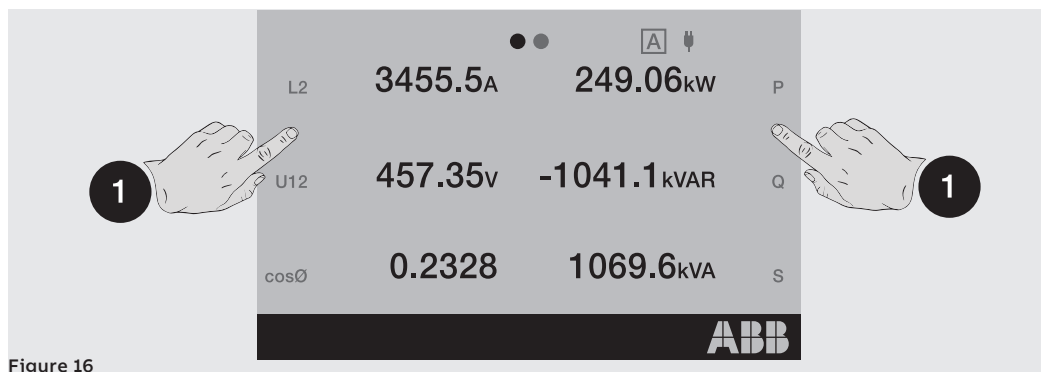

Figure 16



NOTE: both pages can be set as the main page by pressing **HOME**, holding it for five seconds and confirming the message on the display

Measuring instruments

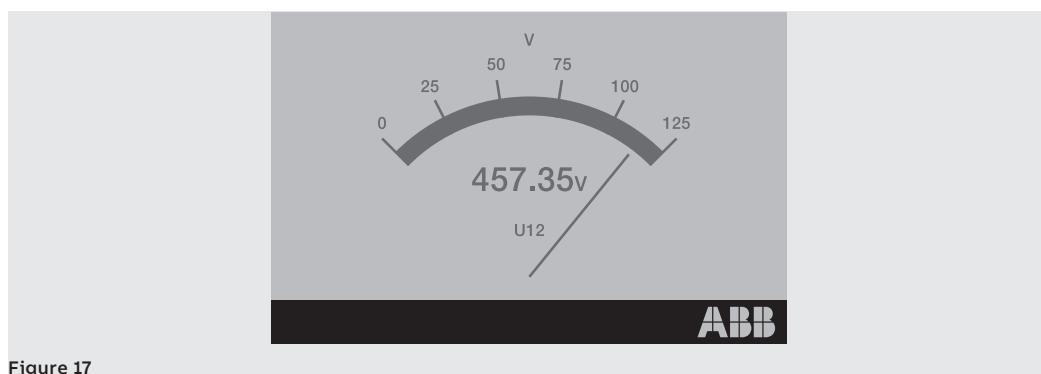

Figure 17

Depending on the Trip unit model, certain measurements acquired in real time are shown on these pages by means of a pointer; each page displays a specific measurement:

Page	Measurement type page	Unit of measurement/indicator
1	Maximum phase current	A
2	Maximum line-to-line voltage	V
3	Total active power	kW
4	Total reactive power	kVAR
5	Total apparent power	kVA

The scale of values ranges from 0 to 125 % and refers to the rated values set (for powers: rated current x rated voltage x $\sqrt{3}$).

Press on the sides of the display to browse the pages; quit the *Measurement tools* section with the **HOME** key.

Page orientation (horizontal by default) can be changed in the *Settings* menu (page 120).



NOTE: each page can be set as the main page by pressing **HOME**, holding it for five seconds and confirming the message on the display

Measurements

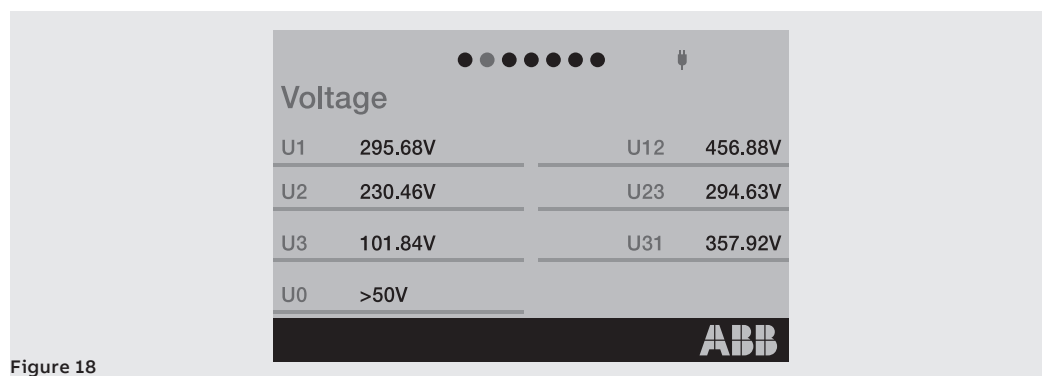

Figure 18

If provided for by Trip unit model, the **Measurements** pages contain a list of measurements acquired in real time, expressed in absolute value:

Page	Name	Measurements
1	Current	Currents: phase, earth fault
2	Voltage	Voltages: line-to-line, phase, neutral
3	Active power	Phase and total active powers
4	Reactive power	Phase and total reactive powers
5	Apparent power	Phase and total apparent powers
6	Energy counters	Total active, reactive and apparent energies
9	Ekip Signalling 3T	Summary of <i>Ekip Signalling 3T</i> module measurements, if installed

Ekip Touch configuration involves certain exceptions:

- the Ne current measurements are available with 4P and 3P + N configurations
- the phase voltage measurements are available with the 4P and 3P + active external neutral voltage configuration
- with the 3P configuration, pages: *Active Power*, *Reactive Power* and *Apparent Power* are replaced by the *Powers* page with the total active, reactive and apparent power measurements

Press the sides of the display to browse the pages; press the **HOME** key to quit.



NOTE: each page can be set as the main page by pressing HOME, holding it for five seconds and confirming the message on the display

Diagnosis bar and Alarm list

The Diagnosis bar lists the faults detected by the unit. It shows a detail of each alarm for about two seconds.



Figure 19

Select the bar to access the *Alarm List* page, with the list of alarms present.

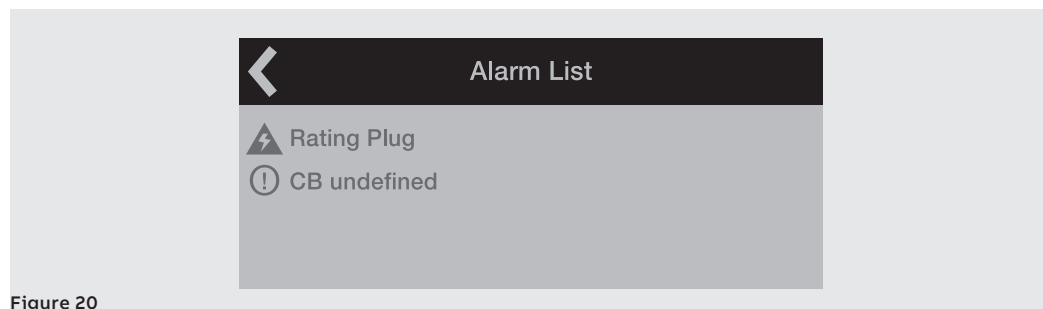

Figure 20



NOTE: the *Alarm List* page also appears when the *iTEST* button is pressed in the cases provided for and described on page 25

Each signal is followed by an icon that identifies the type of alarm:

Icon	Alarm type
	Alarm
	Warning, error or prealarm
	About
	Timing due to tripped protection

The complete list of alarms is given on page 19.

4 - Menu

Introduction Press **Enter** or **ESC** from the main page to access the different menus of the Trip unit.

The menus are the 4th level pages that can be displayed and comprise list of:

- submenus
- settable parameters
- information and measurements
- commands that can be executed

Selection of each menu item enables: access to submenus, consultation of information in detail, configuration of a parameter, execution of a command.

Elements of each item The items in each list consist of:

- main name (white color)
- additional description or set value (light blue color)

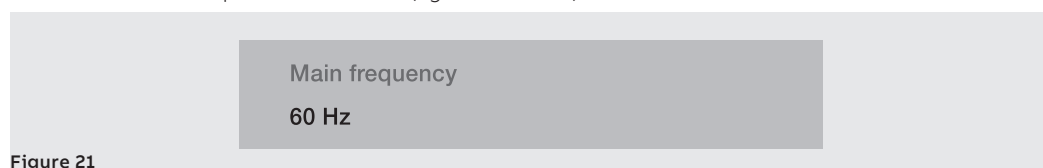

Figure 21

Protections Menu The *Protections* menu can be used to configure the following protections ⁽¹⁾:



Name	Parameters	SW package	Page
L	List and description in dedicated chapter	Standard Protections	42
S	List and description in dedicated chapter		43
S2	List and description in dedicated chapter		44
I	List and description in dedicated chapter		45
G ⁽²⁾	List and description in dedicated chapter		46

⁽¹⁾ if the *Adaptive Protections* package is available and *Dual set* has been activated, an intermediate menu where the set can be selected (*Set A / Set B*) will be available before the list of protections page 68

⁽²⁾ available for *LSIG* versions

Advanced menus

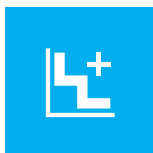

The *Advanced* menu can be used to configure the following protections ⁽¹⁾:

Name	Parameters	SW package	Page
MCR	List in dedicated chapter		47
2I	List in dedicated chapter	Standard Protections	48
IU	List in dedicated chapter		49
UV ⁽²⁾	List in dedicated chapter	Voltage protections	51
OV ⁽²⁾	List in dedicated chapter		52
UV2 ⁽²⁾	List in dedicated chapter		52
OV2 ⁽²⁾	List in dedicated chapter		53
VU ⁽²⁾	List in dedicated chapter		53
S(V) ⁽²⁾	List in dedicated chapter	Voltage Advanced protections	54
S2(V) ⁽²⁾	List in dedicated chapter		55
RV ⁽²⁾	List in dedicated chapter		57
UF ⁽²⁾	List in dedicated chapter	Frequency protections	58
OF ⁽²⁾	List in dedicated chapter		59
UF2 ⁽²⁾	List in dedicated chapter		59
OF2 ⁽²⁾	List in dedicated chapter		60
RP ⁽²⁾	List in dedicated chapter	Power protections	61
D ⁽²⁾	List in dedicated chapter		62
RQ ⁽²⁾	List in dedicated chapter		65
OQ ⁽²⁾	List in dedicated chapter		64
UP ⁽²⁾	List in dedicated chapter		65
OP ⁽²⁾	List in dedicated chapter		64
ROCOF ⁽²⁾	List in dedicated chapter	ROCOF protections	67
R STALL ⁽²⁾	List in dedicated chapter	Motor protections	70
R JAM ⁽²⁾	List in dedicated chapter		70
UC ⁽²⁾	List in dedicated chapter		71
U ⁽²⁾	List in dedicated chapter		71
PTC ⁽²⁾	List in dedicated chapter		72
Signallings	Threshold 1 I1, Threshold 2 I1, Threshold Iw1, Threshold Iw2, Phase Sequence ⁽²⁾ , Cos φ ⁽³⁾	Standard Protections	81
Functions	External Trip, Trip Reset, Switch On SET B ⁽⁴⁾		81
Synchrocheck	List in dedicated chapter	⁽⁵⁾	78

⁽¹⁾ if the *Adaptive Protections* package is available and *Dual set* has been activated, an intermediate menu where the set can be selected (*Set A / Set B*) will be available before the list of protections (page 68); The only menu always present via *Advanced* is *Functions*

⁽²⁾ available if provided for by Trip unit model or if the relative SW package has been activated, where possible (page 6)

⁽³⁾ Cos φ available if provided for by Trip unit model or if the *Power Protections* package has been activated

⁽⁴⁾ *SET B* available when *Adaptive Protections* package is present

⁽⁵⁾ available when *Ekip Synchrocheck* is present

Measurements Menu



Menu	Submenus	Description	Page
Historicals	Trip	Description in dedicated chapter	101
	Events	List of events recorded	101
	Measurements	List and description in dedicated chapter	101
Power factor ⁽¹⁾	-	Power factor measurement	104
Frequency ⁽¹⁾	-	Frequency measured	104
Energy ⁽¹⁾	Energy counters	Measurement of energies	104
	Reset counters	Meter reset command	
	Energy RESET	List and description in dedicated chapter	104
Peak factor ⁽¹⁾	-	Peak factor of each phase	104
Harmonic dist.	-	Activation command for current harmonic distortion monitoring	50
Ekip Synchrocheck ⁽²⁾	-	Description in dedicated chapter	171
Network Analyzer ⁽³⁾	V Sequences	Measurements associated with Network Analyzer function: list and description in dedicated chapter	110
	3s V Sequences		
	THD Current		
	THD Voltages		
	Counters		
	Waveforms		
Maintenance	Contact Wear	Installation and maintenance dates and commands	120
	LastServiceContactWear		
	Installation		
	Last Maintenance		
	Service RESET		

⁽¹⁾ available if provided for by Trip unit model or if SW Measuring Measurements package has been activated

⁽²⁾ available when Ekip Synchrocheck module is present

⁽³⁾ available if provided for by Trip unit model or if Network Analyzer SW package has been activated

Settings Menu



Menu	Submenus	Description and parameters	Page
Bluetooth Low Energy	Enable ⁽⁵⁾	Enabling and configuration of Bluetooth Low Energy communication	118
	-		
Circuit Breaker	Configuration ⁽¹⁾	Phase number selection	117
	Hardware Trip	Protection activation command	50
	T Protection	Protection activation command	50
	Neutral Protection ⁽²⁾	Enable, Neutral threshold	50
	Installation	Installation of modules	36
Main Frequency	-	Grid frequency configuration	117
Phase Sequence	-	Phase sequence configuration	53
Modules	Local/Remote	Parameter writing configuration	118
	Local Bus	Configuration of local bus presence	118
	Modul x ⁽³⁾	Details in chapters of each module	118
	Functions	Switch On LOCAL, Signalling RESET	118
Monitor time	-	Measuring range configuration	102
Test Bus	-	Test bus activation	120
Network Analyzer ⁽⁶⁾	Enable ⁽⁵⁾	Function enabling and parameters: see details in dedicated chapter	110
	-		110
Datalogger ⁽⁶⁾	Enable ⁽⁵⁾	Function enabling and parameters: see details in dedicated chapter	108
	-		108
Dual Set ⁽⁶⁾	Enable ⁽⁵⁾	Function enabling and parameters: see details in dedicated chapter	68
	Default set		68
System	Date	Configuration of unit date	120
	Time	Configuration of unit time	120
	Language	Configuration of menu language	120
	New PIN	PIN Configuration	120
View	-	Representation parameters of menus and measurements: see details in dedicated chapter	120
Functions	YO Command	Function, Delay	78
	YC Command		78
Maintenance	Alarms	Activation of maintenance signals	103
MLRIU ⁽⁷⁾	-	Motor protection parameters: see details in dedicated chapter	68

⁽¹⁾ with CB in 3P configuration

⁽²⁾ available with CB in 4P or 3P with neutral configuration

⁽³⁾ the menu populates with the list of modules detected with the Local Bus activated and in the envisaged connection and supply conditions

⁽⁴⁾ available if the function has been installed in the Trip unit

⁽⁵⁾ the list of the specific submenu populates when enabled function (=On)

⁽⁶⁾ available if provided for by Trip unit model or if relative SW package has been activated

⁽⁷⁾ available with Ekip M Touch

Installation menu

If Ekip Touch detects that *Rating Plug* or *Measurement* module have not been installed properly, it signals an alarm (page 19) and completes *Settings* menu with the specific installation section:

Menu	Submenus 1	Submenus 2	Commands
Circuit Breaker	Installation	Rating Plug	Install
		Ekip Measuring	Install

Correct installation is confirmed by a message on the display and disappearance of the alarm signal and installation menu.



NOTE: availability of submenus depends on the module, which appears to have not been installed

Test Menu

Menu	Submenus	Description, parameters and Commands	Page
Autotest	-	Autotest command	124
Trip Test	-	TRIP command	124
Test CB	-	Close CB, Open CB	124
Ekip CI ⁽⁵⁾	-	Autotest command	125
Ekip Signalling 2K ⁽¹⁾	Ekip Signalling 2K-1 ⁽¹⁾	Module autotest command	125
	Ekip Signalling 2K-2 ⁽¹⁾		
	Ekip Signalling 2K-3 ⁽¹⁾		
ZoneSelectivity ⁽²⁾	S Protection ⁽³⁾	Input, Force Output, Release Output	125
	G Protection ⁽⁴⁾		

⁽¹⁾ available if one or more Ekip Signalling modules are connected and detected by Ekip Touch

⁽²⁾ available if Ekip Touch is on with auxiliary supply

⁽³⁾ available with S and/or S2 and/or D protection enabled, for S protection the set curve must be t=k

⁽⁴⁾ available with G and/or D protection enabled and curve t=k

⁽⁵⁾ available if the Ekip CI module is connected and detected by Ekip Touch

About Menu

Menu	Submenus	Information provided
Protection Unit	-	Information about Ekip Touch: Trip unit serial number, type, version, standard, SW version, date and time, language
Circuit Breaker	-	CB information: TAG name, CB name, rated current, number of poles, CB status and position, total operations, CB serial number
IEC 61557-12 ⁽¹⁾	-	Status of 1% measurements (from <i>Class 1 Power & Energy Metering</i> package), serial number of assembly and current sensors connected
Feature Collection	-	List of tripped protections in Trip unit
Modules	Modul x ⁽²⁾	Module information: serial number, SW version, status of inputs/outputs/contacts (if present)

⁽¹⁾ available if *Class 1 Power & Energy Metering* SW package is provided for by Trip unit module or if it has been previously activated

⁽²⁾ available if one or more modules are connected and detected by unit

5 - Changing parameters and commands

Changing parameters



Comply with the following procedure to change one or more parameters:

IMPORTANT: parameters can be changed with Trip unit in the Local mode and in the absence of timing alarms

1. Select parameter and enter PIN, if required
2. Select new value from list or with the aid of page commands
3. Select Confirm command if present:

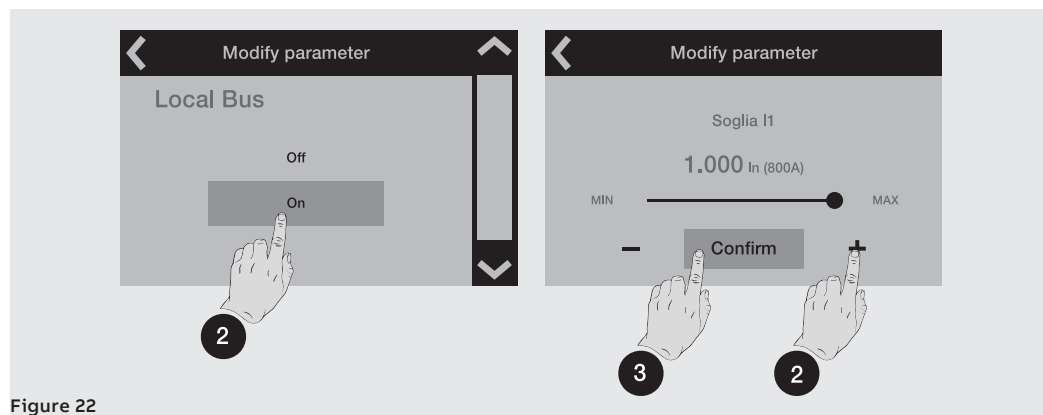

Figure 22

4. When the new value has been selected/confirmed, the menu of the parameter is accessed automatically, the changed item presents the new value in light blue and a tick to confirm:

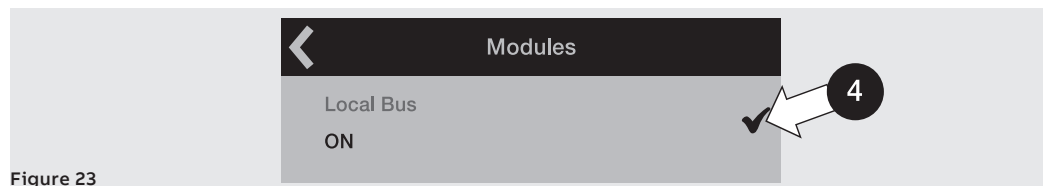

Figure 23

Now proceed by confirming the programming (Step 5) and make further changes (Step 1).

or access other parameters

Select the arrow at the top left to access the top menu until the *Programming* page appears:

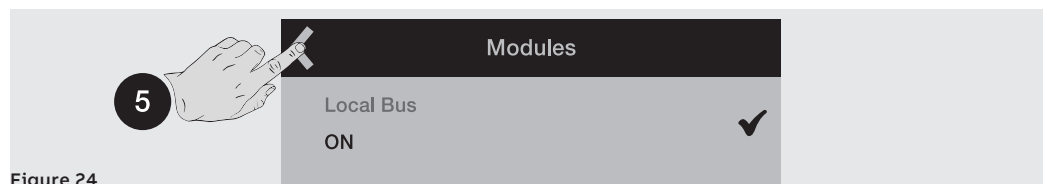

Figure 24

6. Various commands are enabled in the programming page:

- *Confirm* to validate the new parameters and conclude the programming procedure
- *Abort* to interrupt the save data process
- *Modify* to go back to the menus and change the parameter or others

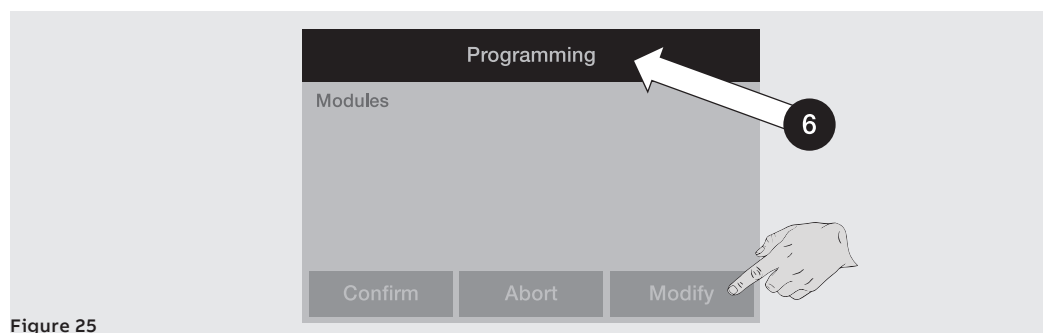

Figure 25

Commands



Selection of a command implies its immediate execution or opening of an intermediate confirm window. Correct execution is indicated by a confirm window, which disappears automatically from the display.

Certain commands, selection of which immediately activates the respective test sequences without any confirm window, are an exception to this rule:

- *Auto Test*
- *Ekip Signalling 2K* module commands



IMPORTANT: confirmation on the display refers to launching the command, not to verification of the operation required, which is at the user's charge whichever type of command is concerned: reset parameters, display, open/close contacts

Exceptions



Before validating a change to a parameter, the Trip unit checks all its parameters to make sure there is no conflict or incorrect condition:

- if the Trip unit detects an incorrect condition, the relative details appear on the display and parameter modification is annulled.

Before executing a command, the Trip unit checks all its parameters to ensure there is no conflict or incorrect condition:

- if the Trip unit detects an incorrect condition, the relative details appear on the display and command execution is annulled.



WARNING! aborting the programming affects all the parameters modified during the same session

6 - PIN and security

Safety  **WARNING! the user is responsible for security against unauthorized access and modification: configure all Trip unit access points (display menu and, if present, Ekip Connect and remote communication systems) using the access PIN and controlled and authorized connection systems**

Function The PIN code enables access to certain areas of the Trip unit and prevents unintentional setting errors from being entered via the display.

However, parameters can still be modified without having to enter the PIN via:

- service connector, using *Ekip T&P* or *Ekip Programming* and the Ekip Connect application
- bus, in the presence of Ekip Com modules and with Trip unit configured as Remote (page 119).

To ensure your unit is in secure conditions, the Wizard window immediately asks you to change the PIN code on first power up; this is strongly recommended by ABB (page 17).

Description The PIN code is a number formed by five digits, each of which can be given a value from 0 to 9; the default value is: **00001** and can be changed in the *Settings-New PIN* menu.

The PIN code must be entered to:

- change a parameter (including the PIN code itself)
- access the *Test* menu

Once the PIN code has been entered, all menus can be browsed for two minutes: once two minutes have elapsed, the PIN code must be entered again (depending on the case in question).

 **NOTE:** the PIN code must also be entered again if a programming session has been annulled (page 37).

Entry The following page will appear when the PIN code is requested: change **(1)** and confirm **(2)** each digit to complete the entry process.

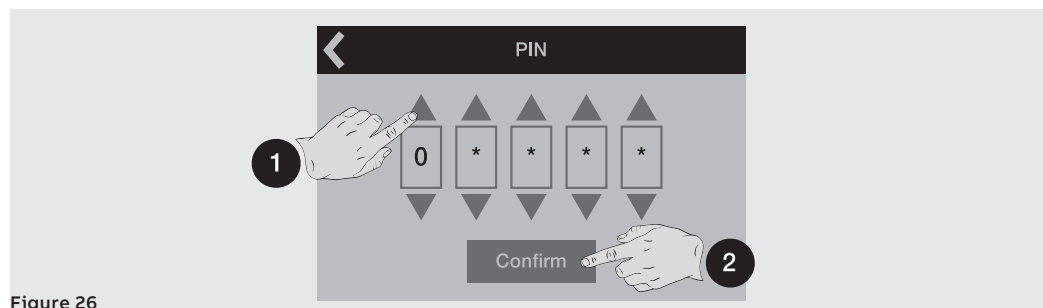



Figure 26

 **NOTE:**

- if the PIN is wrong, "Wrong PIN" will appear for three seconds after which the entry page will be displayed again; use the command at the top left to quit
- there is no limit to the number of wrong PIN that can be entered

Disabling The PIN code can be disabled by entering its value as: 00000; In this case, the PIN is only required to change the PIN itself in the *Settings* menu.

Recovery Contact ABB directly if PIN code is lost.

Protections

1 - Protections - Introduction

Operating principle The protection functions are available with all Ekip Touch models and versions.

Each protection is associated with a different signal (current, voltages, frequencies, powers, etc) but the operating principle is the same:

1. If the signal measured exceeds the set **threshold**, the specific protection activates (prealarm and/or **alarm**).
2. The **alarm** appears on the display and, after a period of time (timing t_p), depending on the protection parameters set, can convert into a **trip command (TRIP)** transmitted to the internal Trip coil of the CB.



NOTE:

- if the signal measured drops below the set threshold before the trip time has elapsed, Ekip Touch quits the alarm and/or timing status and returns to the normal operating condition
- all protections have a default configuration: check the parameters and change to suit the installation requirements before putting into service

TRIP When the Ekip CI module is present, Ekip M Touch allows a different TRIP configuration to be selected so that, if a trip occurs, a contact of the Ekip CI module connected to an external remote control switch is commanded (Normal mode).



NOTE: TRIP is always controlled by a command to the Trip Coil for protections I and G

Consult the parameters used with Ekip Touch MLRIU for further details (page 121).

References Many of the protection thresholds are displayed in two different quantities: absolute value and relative value.

The relative value depends on the type of measurement:

Type of protection	Reference	Description
Current	I_n	Nominal current of the <i>Rating plug</i>
Voltage	U_n	Line-to-line voltage setting
Frequency	f_n	Frequency setting
Power	S_n	$\sqrt{3} \times I_n \times U_n$

Protections packages The protections described in the following chapters are grouped into packages, the availability of which depends on the model and version of the Trip unit, and on their ability to be installed as additional package:

Package	Page
Standard Protections	41
Voltage protections	51
Voltage Advanced protections	54
Frequency protections	58
Power protections	61
ROCOF protections	67
Adaptive protections	68
Motor protections	69
Additional protections and functions	73

2 - Standard Protections

List The Standard protections available for all Ekip Touch models, are:

Name	Type of protection	Page
L	Overload with inverse long-time delay	42
S	Selective short-circuit	43
S2	Short-circuit with adjustable delay	44
I	Instantaneous short-circuit	45
G ⁽¹⁾	Earth fault with adjustable delay	46
MCR	Instantaneous short-circuit on circuit-breaker closing	47
2I	Instantaneous short-circuit programmable	48
IU	Current unbalance	49
Neutral ⁽³⁾	Different protection on neutral phase	49
Harmonic distortion	Distorted waveforms	50
T	Abnormal temperatures	50
Hardware Trip	Internal connection errors	50
Inst ⁽²⁾	Instantaneous short-circuit at high currents	50

⁽¹⁾ not available with LSI version of Ekip Touch

⁽²⁾ protection cannot be deactivated; its trip parameters are set by ABB and cannot be edited

⁽³⁾ not available with Ekip M Touch

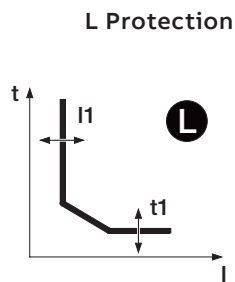

Function

If the current of one or more phases exceeds threshold I_1 , the protection trips and, after a time established by the value read and by the parameter settings, transmits the TRIP command.

To check and simulate the trip times in relation to all the parameters, please consult:

- the summary table of the protections with the calculation formulas (page 81)
- the graph with trip curve (from page 84)

Parameters



NOTE: the limitations and default parameters of the Ekip M Touch Trip unit are different from those of the other models. Details are given after the table

Parameter	Description	Default
Curve	Establishes curve dynamics and trip time calculation: <ul style="list-style-type: none"> • $t = k / I^2$ according to IEC 60947-2. • IEC 60255-151 SI • IEC 60255-151 VI • IEC 60255-151 EI • $t = k / I^4$ according to 60255-151 	$t = k/I^2$
Threshold I_1	Establishes the value that activates the protection and contributes towards calculating the trip time. The value is given as both absolute value (A) and relative value (I_n) and can be set within the range: 0.4 I_n to 1 I_n , in 0.001 I_n steps	1 I_n
Time t_1	Contributes towards calculating the trip time. The value is given in seconds and can be set within the range: 3 s .. 48 s (for curve $t = k / I^2$) or 3 s .. 9 s (for the other curves), in 1 s steps	48 s
Thermal memory	Activates/deactivates the thermal memory function (page 73) NOTE: the function is always ON with Ekip M Touch and available with curve $t = k / I^2$ for all the other trip unit models	OFF
Prealarm I_1	Warns that the measured current is near to protection activation threshold I_1 . The value is given in percentage of threshold I_1 and can be set within the range: 50% I_1 to 90% I_1 , in 1% steps. NOTA: the prealarm condition deactivates in two cases: <ul style="list-style-type: none"> • current lower than prealarm threshold I_1 • current higher than threshold I_1 	90 % I_1

Ekip M Touch

With Ekip M Touch, L protection features the following differences compared to the other models:

- *Curve*: non-editable; specific for Ekip M Touch (page 87)
- *Time t_1* : non-editable; determined by the Trip class (page 69)
- *Thermal memory*: always enabled, functions according to standard IEC 60255-8; thermal memory reset time is established by the *Trip class* (page 69)
- Different default parameters: $I_1 = 0.4 I_n$; $t_1 = 45$ s (Class = 20E)

Limitations and additional functions

- threshold I_1 must be lower than threshold I_2 (if S protection is activated)
- the trip time of the protection is forcibly set at 0.5 s if the calculation results give a lower theoretical value and/or if the current reading is more than 12 I_n
- with CB in UL standard configuration, the only available curve is $t = k/I^2$

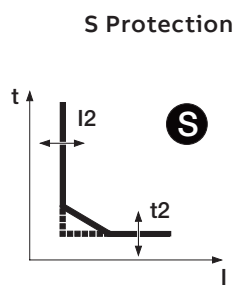
**Function**

If the current of one or more phases exceeds threshold I_2 , the protection trips and, after a time established by the value read and by the parameter settings, transmits the TRIP command.

To check and simulate the trip times in relation to all the parameters, please consult:

- the summary table of the protections with the calculation formulas (page 81)
- the graph with trip curve (page 87)

Parameters

Parameter	Description	Default
<i>Enable</i>	Activates/deactivates the protection and its availability in the parameters menu.	OFF
<i>Trip Enable</i>	Activates/deactivates transmission of the open command. if disabled, the alarm and exceedance of protection time are only managed as information.	ON
<i>Curve</i>	Establishes curve dynamics and the threshold or trip time calculation: <ul style="list-style-type: none"> • $t = k$: fixed time trip • $t = k/I^2$: inverse time-delay dynamic trip 	$t = k$
<i>Threshold I_2</i>	Establishes the value that activates the protection and contributes towards calculating the trip time. The value is given as both absolute value (A) and relative value (In) and can be set within the range: 0.6 In to 10 In, in 0.1 In steps	2 In
<i>Time t_2</i>	It is the trip time or contributes towards timing calculation, depending on the type of curve selected. The value is given in seconds and can be set within the range: 0.05 s to 0.8 s, in 0.01 s steps	0.1 s
<i>Thermal memory</i>	Activates/deactivates the thermal memory function (page 73) i NOTE: the function is only available with curve $t=k/I^2$	OFF
<i>ZoneSelectivity</i>	Activates/deactivates the function and selectivity time availability on the display (page 73) i NOTE: the function is only available with curve $t=k$	OFF
<i>Selectivity time</i>	This is the trip time of the protection with the zone selectivity function activated and selectivity input not present (page 73) The value is given in seconds and can be set within the range: 0.04 s to 0.2 s, in 0.01 s steps	0,04 s
<i>StartUp enable</i>	Activates/deactivates the function and availability of the associated parameters on the display (page 76)	OFF
<i>StartUp Threshold</i>	Protection threshold valid during Startup time, in the conditions in which the function is activated (page 76) The value is given as both absolute value (A) and relative value (In) and can be set within the range: 0.6 In to 10 In, in 0.1 In steps	0,6 In
<i>StartUp Time</i>	This is the time for which the StartUp threshold remains activated, as calculated from the moment the activation Threshold is exceeded (page 76) The value is given in seconds and can be set within the range: 0.1 s to 30 s, in 0.01 s steps	0.1 s

Limitations and additional functions

- threshold I_2 must be higher than threshold I_1 (if S protection is activated)
- in the presence of curve $t = k/I^2$, the protection trip time is forced to t_2 if the calculation results give a theoretical value lower than t_2 itself
- the block functions and type of selectivity can also be accessed by means of the service connector (via Ekip Connect) or communication via system bus (page 73)
- with CB in UL standard configuration, the maximum value of t_2 is 400 ms

S2 Protection Function

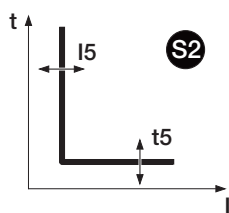

S2 protection functions in the same way as S protection: if the current of one or more phases exceeds threshold I_5 for longer than time t_5 , the protection activates and sends a TRIP command.



NOTE: unlike S protection, S2 protection only has one fixed time trip curve and has no thermal memory

It is independent of S protection, thus thresholds and functions of the two protections can be programmed so as to take advantage of different plant solutions (example: signaling with S and open command with S2 or vice versa, or both S and S2 for signaling or tripping).

To check and simulate the trip times in relation to all the parameters, please consult:

- the summary table of the protections with the calculation formulas (page 81)
- the graph with trip curve (page 88)

Parameter	Description	Default
<i>Enable</i>	Activates/deactivates the protection and its availability in the parameters menu.	OFF
<i>Trip Enable</i>	Activates/deactivates transmission of the open command. if disabled, the alarm and exceedance of protection time are only managed as information.	ON
<i>Threshold I5</i>	Establishes the value that activates the protection and contributes towards calculating the trip time. The value is given as both absolute value (A) and relative value (In) and can be set within the range: $0.6 I_n$ to $10 I_n$, in $0.1 I_n$ steps	$2 I_n$
<i>Time t5</i>	This is the trip time of the protection. The value is given in seconds and can be set within the range: 0.05 s to 0.8 s, in 0.01 s steps	0,05 s
<i>ZoneSelectivity</i>	Activates/deactivates the function and selectivity time availability on the display (page 73) NOTE: if at least two of the selectivity S, S2, I, 2I and MCR are enabled, the input and output are shared with the OR function; it is sufficient that even a selectivity is activated to stimulate inputs and outputs	OFF
<i>Selectivity time</i>	This is the trip time of the protection with the zone selectivity function activated and selectivity input not present (page 73) The value is given in seconds and can be set within the range: 0.04 s to 0.2 s, in 0.01 s steps	0,04 s
<i>Startup enable</i>	Activates/deactivates the function and availability of the associated parameters on the display (page 76)	OFF
<i>Startup Threshold</i>	Protection threshold valid during Startup time, in the conditions in which the function is activated (page 76) The value is given as both absolute value (A) and relative value (In) and can be set within the range: $0.6 I_n$ to $10 I_n$, in $0.1 I_n$ steps	$2 I_n$
<i>Startup Time</i>	This is the time for which the Startup threshold remains activated, as calculated from the moment the activation Threshold is exceeded (page 76) The value is given in seconds and can be set within the range: 0.1 s to 30 s, in 0.01 s steps	0.1 s

Limitations and additional functions

- threshold I_5 must be higher than threshold I_1 (if S2 protection is activated)
- the block functions and type of selectivity can also be accessed by means of the service connector (via Ekip Connect) or communication via system bus (page 75)
- with CB in UL standard configuration, the maximum value of t_5 is 400 ms

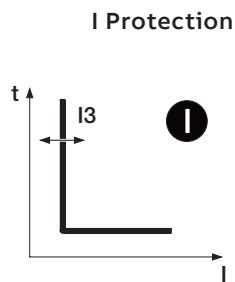
**Function**

If the current of one or more phases exceeds threshold I_3 , the protection trips and, after a non-programmable fixed time, transmits the TRIP command.

To check and simulate the trip times in relation to all the parameters, please consult:

- summary table of the protections with the operating characteristics (page 81)
- the graph with trip curve (page 89)

Parameters

Parameter	Description	Default
<i>Enable</i>	Activates/deactivates the protection and its availability in the parameters menu.	ON
<i>Threshold I3</i>	Establishes the value that activates the protection. The value is given as both absolute value (A) and relative value (I_n) and can be set within the range: $1.5 I_n$ to $15 I_n$, in $0.1 I_n$ steps	$4 I_n$
<i>ZoneSelectivity</i>	Activates/deactivates the function i NOTE: if at least two of the selectivity S, S2, I, 2I and MCR are enabled, the input and output are shared with the OR function; it is sufficient that even a selectivity is activated to stimulate inputs and outputs	OFF
<i>Startup enable</i>	Activates/deactivates the function and availability of the associated parameters on the display (page 75)	OFF
<i>Startup Threshold</i>	Protection threshold valid during Startup time, in the conditions in which the function is activated (page 75) The value is given as both absolute value (A) and relative value (I_n) and can be set within the range: $1.5 I_n$ to $15 I_n$, in $0.1 I_n$ steps	$1,5 I_n$
<i>Startup Time</i>	This is the time for which the Startup threshold remains activated, as calculated from the moment the activation Threshold is exceeded (page 75) The value is given in seconds and can be set within the range: 0.1 s to 30 s, in 0.01 s steps	0.1 s

Ekip M Touch

With Ekip M Touch, I protection is inhibited for 100 ms if the currents detected by the Trip unit cross zero when at least one is present ($0.25 I_n$ fixed control threshold).

Limitations and additional functions

- protection cannot be deactivated in “Non-defeatable instantaneous protection” version; consult catalog for further details ([1SDC200023D0209](#))
- threshold I_3 must be higher than threshold I_2 (if S and I protections are activated)
- I protection can be activated with MCR protection disabled
- the block functions can also be accessed by means of the service connector (via Ekip Connect) or communication via system bus (page 76)

**Function**

Ekip Touch calculates the vector sum of the phase currents (L1, L2, L3, Ne) and obtains the internal earth fault current (I_g): if current I_g exceeds threshold I_4 , the protection trips and, after a time established by the value read and by the parameter settings, transmits the TRIP command.

To check and simulate the trip times in relation to all the parameters, please consult:

- the summary table of the protections with the calculation formulas (page 81)
- the graph with trip curve (page 90)

Parameters

Parameter	Description	Default
<i>Enable</i>	Activates/deactivates the protection and its availability in the parameters menu.	OFF
<i>Trip Enable</i>	Activates/deactivates transmission of the open command. if disabled, the alarm and exceedance of protection time are only managed as information.	ON
<i>Curve</i>	Establishes curve dynamics and the threshold or trip time calculation: <ul style="list-style-type: none"> • $t = k$: fixed time trip • $t = k/I^2$: inverse time-delay dynamic trip 	$t = k$
<i>Threshold I_4</i>	Establishes the value that activates the protection and contributes towards calculating the trip time. The value is given as both absolute value (A) and relative value (I_n) and can be set within the range: 0.1 I_n to 1 I_n , in 0.001 I_n steps	0,2 I_n
<i>Time t_4</i>	It is the trip time or contributes towards timing calculation, depending on the type of curve selected. The value is given in seconds and can be set within the range: 0.1 s to 1 s, in 0.05 s steps <i>i</i> NOTE: in the presence of curve: $t = k$, t_4 can also be configured as: instantaneous; in this mode, the trip time is comparable to that given for I protection (page 81)	0.1 s
<i>Prealarm I_4</i>	Warns that the measured current is near to the protection activation threshold. The value is given in percentage of threshold I_1 and can be set within the range 50% I_4 to 90% I_4 , in 1% steps. The prealarm condition deactivates in two cases: <ul style="list-style-type: none"> • current lower than prealarm threshold I_4 • current higher than threshold I_4 	90 % I_4
<i>ZoneSelectivity</i>	Activates/deactivates the function and selectivity time availability on the display (page 73) <i>i</i> NOTE: the function is only available with curve $t = k$	OFF
<i>Selectivity time</i>	This is the trip time of the protection with the zone selectivity function activated and selectivity input not present (page 73) The value is given in seconds and can be set within the range: 0.04 s to 0.2 s, in 0.01 s steps	0,04 s
<i>StartUp enable</i>	Activates/deactivates the function and availability of the associated parameters on the display (page 76)	OFF
<i>StartUp Threshold</i>	Protection threshold valid during Startup time, in the conditions in which the function is activated (page 76) The value is given as both absolute value (A) and relative value (I_n) and can be set within the range: 0.2 I_n to 1 I_n , in 0.02 I_n steps	0,2 I_n
<i>StartUp Time</i>	This is the time for which the StartUp threshold remains activated, as calculated from the moment the activation Threshold is exceeded (page 76) The value is given in seconds and can be set within the range: 0.1 s to 30 s, in 0.01 s steps	0.1 s

Continued on the next page

Ekip M Touch

With Ekip M Touch, G protection features the following differences compared to the other models:

- Block *BlockOnStartup* enabled and non-editable (page 76)
- *Startup Time* non-editable and set with the Motor start-up value, depending on the trip class (page 121)
- curve set as $t=k$, non-editable

Limitations and additional functions

- in the presence of curve $t= k/I^2$, the protection trip time is forced to t_4 if the calculation results give a theoretical value lower than t_4 itself
- in the absence of *Vaux*, the minimum threshold is $0.25 I_n$ (for $I_n = 300$ A) or $0.2 I_n$ (for all the other sizes); if lower values are set, the Trip unit forces the threshold to the minimum admissible value and the "Configuration" error appears
- depending on the I_4 threshold setting, the protection deactivates for an I_g higher than: $8 I_n$ with threshold $I_4 \geq 0.8 I_n$; $6 I_n$ with $0.8 I_n > I_4 \geq 0.5 I_n$; $4 I_n$ with $0.5 I_n > I_4 \geq 0.2 I_n$; $2 I_n$ with $I_4 > 0.2 I_n$
- operation with $t_4 =$ instantaneous requires the presence of *Vaux*; in self-supply, the Trip unit forces the time to 100 ms and the "Configuration" error appears
- the block functions and type of selectivity can also be accessed by means of the service connector (via Ekip Connect) or communication via system bus (page 73)
- with CB in UL standard configuration, the maximum value of t_4 is 400 ms

Protection MCR Function

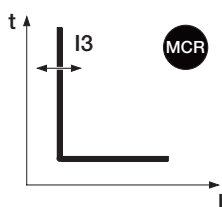

The protection remains activated for a time interval running from the open - closed change of status of the CB, after which it deactivates.

If, during this time interval, the current of one or more phases exceeds threshold I_3 , the protection transmits the TRIP command after a non-programmable fixed time.

The MCR protection only functions with *Vaux*.

To check and simulate the trip times in relation to all the parameters, please consult:

- summary table of the protections with the operating characteristics (page 81)
- the graph with trip curve (page 89)



NOTE: to activate MCR, protection I must be disabled

Parameter	Description	Default
<i>Enable</i>	Activates/deactivates the protection and its availability in the parameters menu.	OFF
<i>Threshold I3</i>	Establishes the value that activates the protection. The value is given as both absolute value (A) and relative value (I_n) and can be set within the range: $1.5 I_n$ to $10 I_n$, in $0.1 I_n$ steps	$6 I_n$
<i>Monitor Time</i>	Defines the time interval in which the MCR protection remains activated, as calculated from the open - closed change of status. The value is given in seconds and can be set within the range: 0.04 s to 0.5 s, in 0.01 s steps	0,04 s
<i>ZoneSelectivity</i>	Activates/deactivates the function NOTE: if at least two of the selectivity S, S2, I, 2I and MCR are enabled, the input and output are shared with the OR function; it is sufficient that even a selectivity is activated to stimulate inputs and outputs	OFF

Limitations and additional functions

The block functions can also be accessed by means of the service connector (via Ekip Connect) or communication via system bus (page 73)

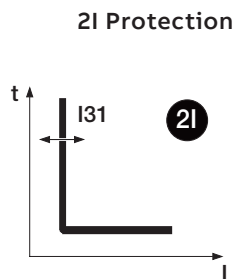

Function

If the current of one or more phases exceeds threshold I31 and a trip event is present, the protection transmits the TRIP command after a non-programmable fixed time.

To check and simulate the trip times in relation to all the parameters, please consult:

- summary table of the protections with the operating characteristics (page 81)
- the graph with trip curve (page 89)

Parameter	Description	Default
<i>Enable</i>	Activates/deactivates the protection and its availability in the parameters menu.	OFF
<i>Threshold I31</i>	Establishes the value that activates the protection. The value is given as both absolute value (A) and relative value (In) and can be set within the range: 1.5 In to 10 In, in 0.1 In steps	1,5 In
<i>ZoneSelectivity</i>	Activates/deactivates the function i NOTE: if at least two of the selectivity S, S2, I, 2I and MCR are enabled, the input and output are shared with the OR function; it is sufficient that even a selectivity is activated to stimulate inputs and outputs	OFF

Protection enabling renders *2I Mode* section available in *Advanced - Functions* menu, where the protection activation event can be configured:

Parameter	Description	Default
<i>Activation</i>	Two alternative modes are available: <ul style="list-style-type: none"> • Dependent function: the protection is activated if the programmed activation event has occurred; this configuration makes the function and delay parameters available • Activated: the protection is always activated 	Dependent function
<i>Function</i>	The activation event between the input contacts of Ekip Signalling 2K, the statuses of the unit (open/closed) and the Custom function can be selected i NOTE: Ekip Connect allows the Custom function to be customized so as to associate the activation event with up to eight statuses in AND or OR configuration	Disabled
<i>Delay ON</i>	Protection activation delay calculated from the presence of the activation event onwards. The value is given in seconds and can be set within range: 0 s to 100 s, in 0.01 s steps i NOTE: the protection trips if the event is present for longer than the set time lag	0 s
<i>Delay OFF</i>	Protection deactivation delay calculated from disappearance of activation event onwards. The value is given in seconds and can be set within range: 0 s to 100 s, in 0.01 s steps i NOTE: protection deactivates if event is not present for longer than set delay	15 s

RELT - Ekip signalling 2K-3

If the RELT module is present a dedicated command (RELT Wizard) will be displayed. This will program the 2I protection and other related parameters; for details see page 163.

Commands by remote control

Two further temporary protection activation/deactivation commands are available when the unit is connected to one or more Ekip Com modules:

- **2I ON Mode:** activates the protection
- **2I OFF Mode:** deactivates the protection

For further details consult the document [1SDH002031A1101](#).

i **NOTE:** if the protection has been activated by command *2I ON Mode*, it is deactivated by command *2I OFF Mode* or when the unit shuts down

Signallings

When protection 2I is activated, the message “2I active” appears in the diagnostic bar and in the Alarm List page, and the alarm led will be on steady.

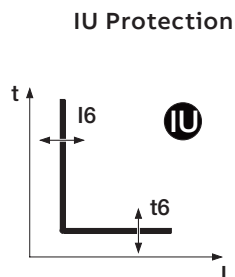
**Function**

The protection trips if the current readings are unbalanced; the protection sends a TRIP command if the detected unbalance exceeds threshold I_6 for longer than t_6 .

The protection is automatically self-excluding in two cases:

- the measurement of at least one current exceeds $6 I_n$
- the maximum current value between all the phases is less than $0.25 I_n$ (in I Avg configuration) or $0.3 I_n$ (in I Max configuration)

To check and simulate the trip times in relation to all the parameters, please consult:

- summary table of the protections with the operating characteristics (page 81)
- the graph with trip curve (page 91)

Parameters

Parameter	Description	Default
<i>Enable</i>	Activates/deactivates the protection and its availability in the parameters menu	OFF
<i>Trip Enable</i>	Activates/deactivates transmission of the open command: if disabled, the alarm and exceedance of protection time are only managed as information	OFF
<i>Algorithm</i>	Allows the unbalance calculation mode to be selected: <ul style="list-style-type: none"> • With respect to I_{max}: % Sbil = $100 \times (I_{max} - I_{min}) / I_{max}$ • With respect to: I_{Avg}: % Sbil = $100 \times (\max I_{Avg}) / I_{Avg}$ NOTE: $\max I_{Avg}$: maximum deviation among the measured currents, calculated by comparing each current with the mean value; I_{Avg} : mean value of the current readings	With respect to I_{max}
<i>Threshold I_6</i>	Establishes the unbalance value that trips the protection. Unbalance is given in percentage value within the range: 2% to 90% with 1% steps.	50 %
<i>Time t_6</i>	This is the trip time of the protection; the value is given in seconds and can be set within a range: 0.5 s to 60 s, in 0.5 s steps	5 s

Ekip M Touch

With Ekip M Touch, IU protection features the following differences compared to the other models:

- version set as With respect to I_{Avg} , cannot be edited
- protection is inhibited if the rms value of at least one of the phase currents is less than $0.25 I_n$.

Neutral Protection**Function**

Neutral protection characterizes protections L, S and I differently on the neutral phase by introducing a different control factor from the other phases.

The protection is available with the 4P and 3P + N configuration; the configuration parameters can be accessed via the Settings menu (page 35).

Parameters

Parameter	Description	Default
<i>Enable</i>	Activates/deactivates the protection	OFF
<i>Neutral threshold</i>	Defines the multiplicative factor applied to the trip thresholds and curves of the protections for the current read on phase Ne: <ul style="list-style-type: none"> • 50 %: lowest trip thresholds for the neutral current • 100 %: same trip thresholds for all phases • 150 %: highest trip thresholds for the neutral current • 200 %: highest trip thresholds for the neutral current 	50 %

Limitations and additional functions

Ekip Touch rejects modification of thresholds I_1 and I_n in the absence of the following limitation: $(I_1 \times I_n) \leq I_u$

- I_1 is the threshold of L protection in amperes (example: $I_n = 400$ A and $I_1 = 0.6$ becomes $I_1 = 240$ A)
- I_n is the neutral threshold expressed as multiplicative factor (example: $I_n = 200\%$ becomes $I_n = 2$)
- I_u is the size of the CB



WARNING! With 150% and 200% threshold; if the measured neutral current exceeds $16 I_n$, the Trip unit resets the protection to 100% by itself

Harmonic Distortion Protection

Allows an alarm to be activated in the case of distorted waveforms.

The protection can be enabled in the *Measurements* menu; if enabled an alarm is activated (page 34).



IMPORTANT: the protection does not handle the trip, just the signal

T Protection

T protection protects against abnormal temperatures measured and transmitted to the sensor inside the unit; temperature verification is always active and includes three operating states:

State	Temperature range [°C]	Ekip Touch actions
Standard	$-25 < t < 70$	Normal operation; display on ⁽¹⁾
Warnings	$-40 < t < -25$ or $70 < t < 85$	Warning led @ 0.5 Hz; display on ⁽¹⁾
Alarm	$t < -40$ or $t > 85$	Display off; Alarm and Warning leds @ 2 Hz; TRIP if Trip enable is activated

⁽¹⁾ the display remains on within range: $-20\text{ °C} / +70\text{ °C}$

All protections enabled in the unit are active in all operating states.

The Trip Enabling parameter can be enabled in the *Settings - Circuit breaker* menu in order to handle an open command if an alarm occurs (page 35).

Hardware Trip Protection

Hardware Trip protects against connection errors in Ekip Touch and is available in the *Settings - Circuit breaker - Hardware Trip* menu (page 34).

If enabled, with the CB closed, if one or more of these events are detected:

- current sensors disconnected (phase or external if enabled)
- *Rating Plug* disconnected.
- *Trip Coil* disconnected
- faults inside the unit

the alarm is signaled and a TRIP command is transmitted.



IMPORTANT:

- the protection trips if the error statuses persist for more than one second
- the signal is activated in the case of an alarm due to Trip coil disconnection and, in the presence of Vaux, output YO is commanded until the Trip unit detects the CB Open state (make sure that YO, Ekip Actuator, YO coil supply are present)

Inst

The purpose of this protection is to maintain the integrity of the circuit-breaker and installation in the case of particularly high current values requiring shorter reaction times than those provided by the instantaneous short-circuit-protection.

The protection cannot be disabled, the tripping threshold and time are defined by ABB.

3 - Voltage protections

List The Voltage protections, available by default for the Ekip Hi-Touch, Ekip G Touch, Ekip G-Hi Touch and Ekip M Touch models and configurable in the remaining models as additional SW package, are:

Name	Type of protection	Page
UV	Minimum voltage	51
OV	Maximum voltage	52
UV2 ⁽¹⁾	Minimum voltage	52
OV2 ⁽¹⁾	Maximum voltage	53
Phase Sequence	Phase sequence error	53
VU	Voltage unbalance	53

⁽¹⁾ protections UV2 and OV2 are not available by default with Ekip G Touch. However, they can be integrated by requesting the relative SW package

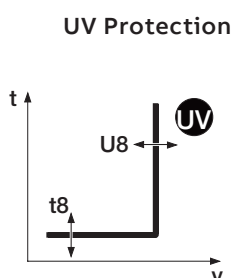

The protection sends a TRIP command if one or more line-to-line voltages detected by the unit drop below threshold $U8$ for longer than $t8$.

To check and simulate the trip times in relation to all the parameters, please consult:

- summary table of the protections with the operating characteristics (page 82)
- the graph with trip curve (page 91)

Parameters

Parameter	Description	Default
<i>Enable</i>	Activates/deactivates the protection and its availability in the parameters menu	OFF
<i>Trip Enable</i>	Activates/deactivates transmission of the open command: if disabled, the alarm and exceedance of protection time are only managed as information	OFF
<i>Threshold $U8$</i>	Establishes the value that activates the protection. Value is given as both absolute value (Volts) and relative value (U_n) and can be set within range: $0.05 U_n$ to $1 U_n$ in $0.001 U_n$ steps	$0,9 U_n$
<i>Time $t8$</i>	This is the trip time of the protection; the value is given in seconds and can be set within a range: $0.05 s$ to $120 s$, in $0.01 s$ steps	$5 s$

Limitations and additional functions

The block functions can also be accessed by means of the service connector (via Ekip Connect) or by connection to the system bus (page 76).

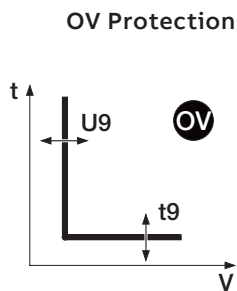
**Function**

The protection sends a TRIP command if one or more line-to-line voltages detected by the unit exceed threshold U_9 for longer than t_9 .

To check and simulate the trip times in relation to all the parameters, please consult:

- summary table of the protections with the operating characteristics (page 82)
- the graph with trip curve (page 92)

Parameters

Parameter	Description	Default
<i>Enable</i>	Activates/deactivates the protection and its availability in the parameters menu	OFF
<i>Trip Enable</i>	Activates/deactivates transmission of the open command: if disabled, the alarm and exceedance of protection time are only managed as information	OFF
<i>Threshold U_9</i>	Establishes the value that activates the protection. The value is given as both absolute value (Volts) and relative value (U_n) and can be set within the range: $1 U_n$ to $1.5 U_n$ in $0.001 U_n$ steps	$1,05 U_n$
<i>Time t_9</i>	This is the trip time of the protection; the value is given in seconds and can be set within a range: $0.05 s$ to $120 s$, in $0.01 s$ steps	$5 s$

Limitations and additional functions

The block functions can also be accessed by means of the service connector (via Ekip Connect) or by connection to the system bus (page 73).

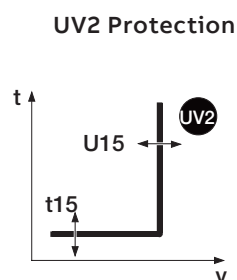
**Function**

UV2 protection functions in the same way as UV protection: the protection sends a TRIP command if one or more line-to-line voltages detected by the unit drop below threshold U_{15} for longer than t_{15} .

It is independent of UV protection, thus thresholds and functions of the two protections can be programmed so as to take advantage of different plant solutions (example: signaling with UV and open command with UV2 or vice versa, or both for signaling or tripping).

To check and simulate the trip times in relation to all the parameters, please consult:

- summary table of the protections with the operating characteristics (page 82)
- the graph with trip curve (page 91)

Parameters

Parameter	Description	Default
<i>Enable</i>	Activates/deactivates the protection and its availability in the parameters menu	OFF
<i>Trip Enable</i>	Activates/deactivates transmission of the open command: if disabled, the alarm and exceedance of protection time are only managed as information	OFF
<i>Threshold U_{15}</i>	Establishes the value that activates the protection. Value is given as both absolute value (Volts) and relative value (U_n) and can be set within range: $0.05 U_n$ to $1 U_n$ in $0.001 U_n$ steps	$0,9 U_n$
<i>Time t_{15}</i>	This is the trip time of the protection; the value is given in seconds and can be set within a range: $0.05 s$ to $120 s$, in $0.01 s$ steps	$5 s$

Limitations and additional functions

The block functions can also be accessed by means of the service connector (via Ekip Connect) or by connection to the system bus (page 73).

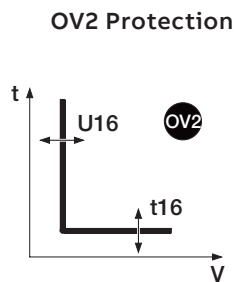
**Function**

OV2 protection functions in the same way as OV protection: the protection sends a TRIP command if one or more line-to-line voltages detected by the unit exceed threshold U16 for longer than t16.

To check and simulate the trip times in relation to all the parameters, please consult:

- summary table of the protections with the operating characteristics (page 82)
- the graph with trip curve (page 92)

Parameters

Parameter	Description	Default
<i>Enable</i>	Activates/deactivates the protection and its availability in the parameters menu	OFF
<i>Trip Enable</i>	Activates/deactivates transmission of the open command: if disabled, the alarm and exceedance of protection time are only managed as information	OFF
<i>Threshold U16</i>	Establishes the value that activates the protection. The value is given as both absolute value (Volts) and relative value (Un) and can be set within the range: 1 Un to 1.5 Un in 0.001 Un steps	1,05 Un
<i>Time t16</i>	This is the trip time of the protection; the value is given in seconds and can be set within a range: 0.05 s to 120 s, in 0.01 s steps	5 s

Limitations and additional functions

The block functions can also be accessed by means of the service connector (via Ekip Connect) or by connection to the system bus (page 76).

Phase sequence protection

The *Phase Sequence* protection enables an alarm to be activated when the sequence of line-to-line voltages is not aligned with the sequence set by the user.

The required sequence can be set in the *Settings* menu and the protection activated in the *Advanced* menu (page 35 and page 33).

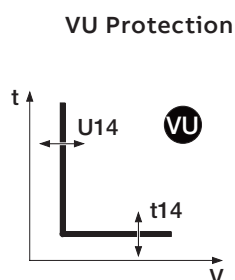
**Function**

The protection trips if the line-to-line voltages read by the unit are unbalanced; the protection sends a TRIP command if the detected unbalance exceeds threshold U14 for longer than t14.

The protection excludes itself if the maximum value of the line-to-line voltage is less than 0.3 Un

To check and simulate the trip times in relation to all the parameters, please consult:

- summary table of the protections with the operating characteristics (page 82)
- the graph with trip curve (page 92)

Parameters

Parameter	Description	Default
<i>Enable</i>	Activates/deactivates the protection and its availability in the parameters menu	OFF
<i>Trip Enable</i>	Activates/deactivates transmission of the open command: if disabled, the alarm and exceedance of protection time are only managed as information	OFF
<i>Threshold U14</i>	Establishes the unbalance value that trips the protection. Unbalance is expressed in percentage value and is calculated in the following way: % Unba = 100 x ($\Delta\max U_{mi}$) / U_{mi} in range: 2% to 90% in 1% steps. i NOTE: $\Delta\max U_{mi}$: maximum deviation among the three voltages calculated by comparing each line-to-line voltage with the mean value; U_{mi} : mean value of the line-to-line voltages	50 %
<i>Time t14</i>	This is the trip time of the protection; the value is given in seconds and can be set within a range: 0.5 s to 60 s, in 0.5 s steps	5 s

Limitations and additional functions

The block functions can also be accessed by means of the service connector (via Ekip Connect) or by connection to the system bus (page 76).

4 - Voltage Advanced protections

- List** The Advanced Voltage protections, available by default for the Ekip G Touch and Ekip G Hi-Touch models and configurable in the remaining models as additional SW package, are:

Name	Type of protection	Page
S(V)	Short-circuit with voltammetric control	54
S2(V) ⁽¹⁾	Short-circuit with voltammetric control	55
RV	Residual voltage	57

⁽¹⁾ S2(V) protection is not available by default with Ekip G Touch. However, it can be integrated by requesting the relative SW package

S(V) Protection Function

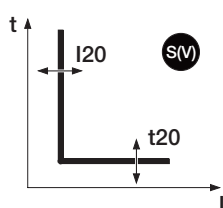

S(V) protection protects against short circuits, with a threshold sensitive to the value of the voltage.

If the current of one or more phases exceeds threshold I_{20} for longer than time t_{20} , the protection activates and sends a TRIP command.

Following a voltage drop, the I_{20} threshold varies according to two different modes:

- **Step** provides for a stepped variation, depending on parameters U_I and K_s .
- **Lin** (linear) provides for a dynamic variation, depending on parameters U_I , U_h and K_s .

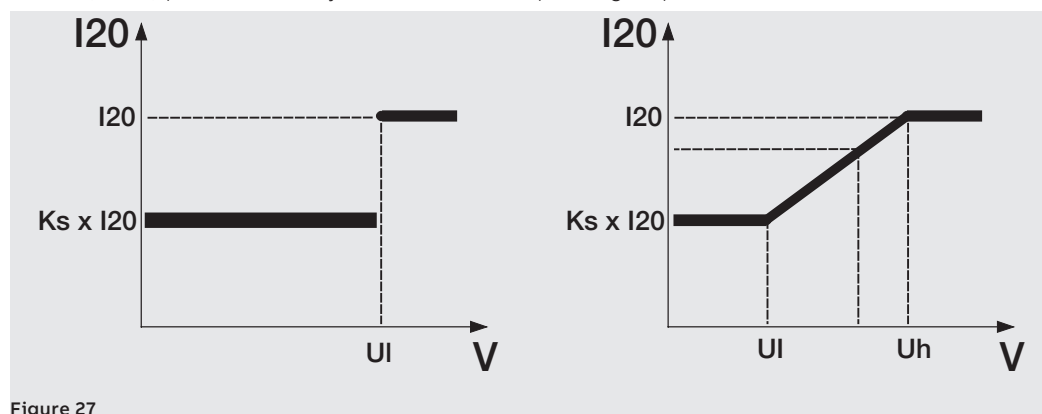

Figure 27

To check and simulate the trip times in relation to all the parameters, please consult:

- the summary table of the protections with the calculation formulas (page 82)
- the graph with trip curve (page 93)

Parameters

Parameter	Description	Default
<i>Enable</i>	Activates/deactivates the protection and its availability in the parameters menu	OFF
<i>Trip Enable</i>	Activates/deactivates transmission of the open command: if disabled, the alarm and exceedance of protection time are only managed as information	OFF
<i>Curve</i>	Allows the operating mode, Step or Lin, to be selected	Scal
<i>Threshold I20</i>	Establishes the value that activates the protection and contributes towards calculating the trip time. The value is given as both absolute value (amperes) and relative value (I_n) and can be set within the range: $0.6 I_n$ to $10 I_n$, in $0.1 I_n$ steps	$1 I_n$

Continued on the next page

Parameter	Description	Default
Threshold U_I	This is the voltage that determines the change in trip threshold I_{20} ; the behavior differs, depending on the mode selected ⁽¹⁾ The value is given as both absolute value (V) and relative value (U_n) and can be set within the range: $0.2 U_n$ to $1 U_n$ in $0.01 U_n$ steps	$1 U_n$
Threshold U_h	The parameter is shown by the Lin curve and contributes towards I_{20} trip threshold calculation: • with voltage reading $< U_h$ (and $\geq U_I$), the threshold changes gradually ⁽¹⁾ • with voltage reading $\geq U_h$, the threshold is I_{20} The value is given as both absolute value (V) and relative value (U_n) and can be set within the range: $0.2 U_n$ to $1 U_n$ in $0.01 U_n$ steps	$1 U_n$
Threshold K_s	I_{20} threshold calculation constant. The value is given as percentage of threshold I_{20} and can be set within the range: $0.1 I_{20}$ to $1 I_{20}$, in 0.01 steps	$0,6 I_{20}$
Time t_{20}	This is the trip time of the protection. The value is given in seconds and can be set within the range: 0.05 s to 30 s, in 0.01 s steps	0.1 s

(1) Trip threshold (depending on the operating curve)

Mode	Voltage reading	Trip threshold
Scal	$< U_I$	$K_s \times I_{20}$
	$\geq U_I$	I_{20}
Lin	$< U_I$	$K_s \times I_{20}$
	$\geq U_I$ ($e < U_h$)	$((I_{20} \times (1 - K_s) \times (U_{mis} - U_h)) / (U_h - U_I)) + I_{20}$

Limitations and additional functions

The block functions can also be accessed by means of the service connector (via Ekip Connect) or by connection to the system bus (page 76).

S(V) Protection Function

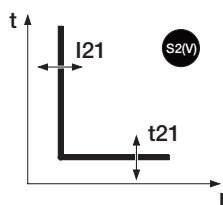

$S_2(V)$ protection functions in the same way as $S(V)$ protection and protects against short-circuits, with threshold sensitive to the voltage value.

It is independent of $S(V)$ protection, thus thresholds and functions of the two protections can be programmed so as to take advantage of different plant solutions (example: signaling with $S(V)$ and open command with $S_2(V)$ or vice versa, or both $S(V)$ and $S_2(V)$ for signaling or tripping).

If the current of one or more phases exceeds threshold I_{21} for longer than time t_{21} , the protection activates and sends a TRIP command.

Following a voltage drop, the I_{21} threshold varies according to two different modes:

- **Step** provides for a stepped variation, depending on parameters U_{I2} and K_{s2} .
- **Lin** (linear) provides for a dynamic variation, depending on parameters U_{I2} , U_{h2} and K_{s2} .

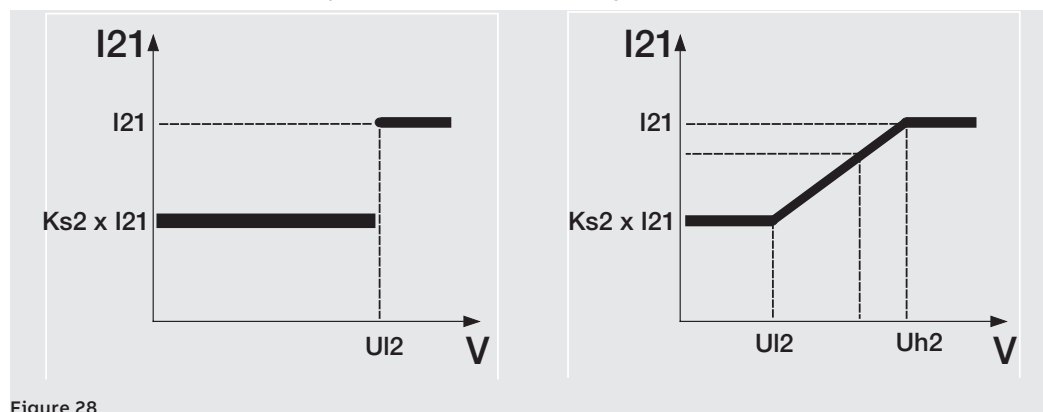

Figure 28

To check and simulate the trip times in relation to all the parameters, please consult:

- the summary table of the protections with the calculation formulas (page 82)
- the graph with trip curve (page 93)

Parameters

Parameter	Description	Default
<i>Enable</i>	Activates/deactivates the protection and its availability in the parameters menu	OFF
<i>Trip Enable</i>	Activates/deactivates transmission of the open command: if disabled, the alarm and exceedance of protection time are only managed as information	OFF
<i>Curve</i>	Allows the operating mode, Step or Lin, to be selected	Scal
<i>Threshold I21</i>	Establishes the value that activates the protection and contributes towards calculating the trip time. The value is given as both absolute value (amperes) and relative value (In) and can be set within the range: 0.6 In to 10 In, in 0.1 In steps	1 In
<i>Threshold UI2</i>	It is the voltage that determines the change in trip threshold I21; the behavior differs, depending on the mode selected ⁽¹⁾ The value is given as both absolute value (V) and relative value (Un) and can be set within the range: 0.2 Un to 1 Un in 0.01 Un steps	1 Un
<i>Threshold Uh2</i>	The parameter is shown by the Lin curve and contributes towards I21 trip threshold calculation: • with voltage reading < Uh2 (and ≥ UI2), the threshold changes gradually ⁽¹⁾ • with voltage reading ≥ Uh2, the threshold is I21 The value is given as both absolute value (V) and relative value (Un) and can be set within the range: 0.2 Un to 1 Un in 0.01 Un steps	1 Un
<i>Threshold Ks2</i>	I21 threshold calculation constant. The value is given as percentage of threshold I21 and can be set within the range: 0.1 I21 to 1 I21, in 0.01 steps	0,6 I21
<i>Time t21</i>	This is the trip time of the protection. The value is given in seconds and can be set within the range: 0.05 s to 30 s, in 0.01 s steps	0.1 s

(1) Trip threshold (depending on the operating curve)

Mode	Voltage reading	Trip threshold
Scal	< UI2	$Ks2 \times I21$
	≥ UI2	I21
Lin	< UIs	$Ks2 \times I21$
	≥ UI2 (e < Uh2)	$((I21 \times (1 - Ks2) \times (U_{mis} - Uh2)) / (Uh2 - UI2)) + I21$

Limitations and additional functions

The block functions can also be accessed by means of the service connector (via Ekip Connect) or by connection to the system bus (page 76).

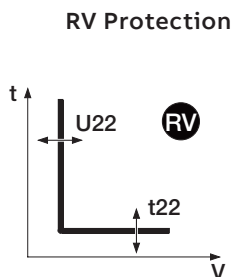

Function

The protection trips if loss of insulation occurs (verification of residual voltage U_0); the protection sends a TRIP command if voltage U_0 exceeds threshold U_{22} for longer than t_2 .

The protection is always available in the 4P configuration; if presence of neutral voltage is activated in *Measurement* module (page 128). protection is also available for 3P and 3P + N configurations.

To check and simulate the trip times in relation to all the parameters, please consult:

- summary table of the protections with the operating characteristics (page 82)
- the graph with trip curve (page 93)

Parameters

Parameter	Description	Default
<i>Enable</i>	Activates/deactivates the protection and its availability in the parameters menu	OFF
<i>Trip Enable</i>	Activates/deactivates transmission of the open command: if disabled, the alarm and exceedance of protection time are only managed as information	OFF
<i>Threshold U_{22}</i>	Establishes the value that activates the protection. The value is given as both absolute value (V) and relative value (U_n) and can be set within the range: 0.05 U_n to 0.5 U_n in 0.001 U_n steps	0,15 U_n
<i>Time t_{22}</i>	This is the trip time of the protection; the value is given in seconds and can be set within a range: 0.05 s to 120 s, in 0.01 s steps	15 s
<i>Reset Time</i>	This is the time the alarm is retained after the protection has quit the alarm condition; it can be useful for keeping the timing activated when the protection is temporarily deactivated. The value is given in seconds and can be set within the range: 0 s to 0.2 s, in 0.02 s steps	0 s

Limitations and additional functions

The block functions can also be accessed by means of the service connector (via Ekip Connect) or by connection to the system bus (page 76).

5 - Frequency protections

List The Frequency protections, available by default for the Ekip Hi-Touch, Ekip G Touch, Ekip G-Hi Touch and Ekip M Touch models and configurable in the remaining models as additional SW package, are:

Name	Type of protection	Page
UF	Minimum frequency	58
OF	Maximum frequency	59
UF2 ⁽¹⁾	Minimum frequency	59
OF2 ⁽¹⁾	Maximum frequency	60

⁽¹⁾ protections UF2 and OF2 are not available by default with Ekip G Touch. However, they can be integrated by requesting the relative SW package

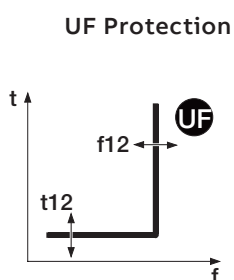

Function

The protection sends a TRIP command if the grid frequency read by the unit drops below threshold f_{12} for longer than t_{12} .

The protection excludes itself if the maximum value of the line-to-line voltage is less than 30 V.

To check and simulate the trip times in relation to all the parameters, please consult:

- summary table of the protections with the operating characteristics (page 82)
- the graph with trip curve (page 94)

Parameters

Parameter	Description	Default
<i>Enable</i>	Activates/deactivates the protection and its availability in the parameters menu	OFF
<i>Trip Enable</i>	Activates/deactivates transmission of the open command: if disabled, the alarm and exceedance of protection time are only managed as information	OFF
<i>Threshold f_{12}</i>	Establishes the value that activates the protection. The value is given as both absolute value (Hertz) and relative value (Fn) and can be set within the range: 0.9 Fn to 1 Fn in 0.001 Fn steps	0,9 Fn
<i>Time t_{12}</i>	This is the trip time of the protection; the value is given in seconds and can be set within a range: 0.06 s to 300 s, in 0.01 s steps	3 s

Limitations and additional functions

The block functions can also be accessed by means of the service connector (via Ekip Connect) or by connection to the system bus (page 76).

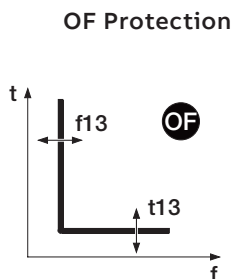
**Function**

The protection sends a TRIP command if the grid frequency read by the unit exceeds threshold f_{13} for longer than t_{13} .

The protection excludes itself if the maximum value of the line-to-line voltage is less than 30 V.

To check and simulate the trip times in relation to all the parameters, please consult:

- summary table of the protections with the operating characteristics (page 82)
- the graph with trip curve (page 94)

Parameters

Parameter	Description	Default
<i>Enable</i>	Activates/deactivates the protection and its availability in the parameters menu	OFF
<i>Trip Enable</i>	Activates/deactivates transmission of the open command: if disabled, the alarm and exceedance of protection time are only managed as information	OFF
<i>Threshold f_{13}</i>	Establishes the value that activates the protection. The value is given as both absolute value (Hertz) and relative value (Fn) and can be set within the range: 1 Fn to 1.1 Fn in 0.001 Fn steps	1,1 Fn
<i>Time t_{13}</i>	This is the trip time of the protection; the value is given in seconds and can be set within a range: 0.06 s to 300 s, in 0.01 s steps	3 s

Limitations and additional functions

The block functions can also be accessed by means of the service connector (via Ekip Connect) or by connection to the system bus (page 76).

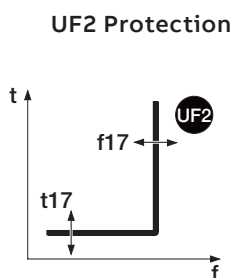
**Function**

UF2 protection functions in the same way as UF protection: the protection sends a TRIP command if the grid frequency read by the unit drops below threshold f_{17} for longer than t_{17} .

It is independent of UF protection, thus thresholds and functions of the two protections can be programmed so as to take advantage of different plant solutions (example: signaling with UF and open command with UF2 or vice versa, or both for signaling or tripping).

The protection excludes itself if the maximum value of the line-to-line voltage is less than 30 V.

To check and simulate the trip times in relation to all the parameters, please consult:

- summary table of the protections with the operating characteristics (page 81)
- the graph with trip curve (page 94)

Parameters

Parameter	Description	Default
<i>Enable</i>	Activates/deactivates the protection and its availability in the parameters menu	OFF
<i>Trip Enable</i>	Activates/deactivates transmission of the open command: if disabled, the alarm and exceedance of protection time are only managed as information	OFF
<i>Threshold f_{17}</i>	Establishes the value that activates the protection. The value is given as both absolute value (Hertz) and relative value (Fn) and can be set within the range: 0.9 Fn to 1 Fn in 0.001 Fn steps	0,9 Fn
<i>Time t_{17}</i>	This is the trip time of the protection; the value is given in seconds and can be set within a range: 0.06 s to 300 s, in 0.01 s steps	3 s

Limitations and additional functions

The block functions can also be accessed by means of the service connector (via Ekip Connect) or by connection to the system bus (page 76).

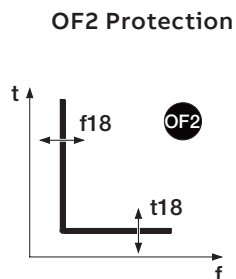

Function

OF2 protection functions in the same way as OF protection: the protection sends a TRIP command if the grid frequency read by the unit exceeds threshold f_{18} for longer than t_{18} .

It is independent of OF protection, thus thresholds and functions of the two protections can be programmed so as to take advantage of different plant solutions (example: signaling with OF and open command with OF2 or vice versa, or both for signaling or tripping).

The protection excludes itself if the maximum value of the line-to-line voltage is less than 30 V.

To check and simulate the trip times in relation to all the parameters, please consult:

- summary table of the protections with the operating characteristics (page 82)
- the graph with trip curve (page 94)

Parameters

Parameter	Description	Default
<i>Enable</i>	Activates/deactivates the protection and its availability in the parameters menu	OFF
<i>Trip Enable</i>	Activates/deactivates transmission of the open command: if disabled, the alarm and exceedance of protection time are only managed as information	OFF
<i>Threshold f_{18}</i>	Establishes the value that activates the protection. The value is given as both absolute value (Hertz) and relative value (Fn) and can be set within the range: 1 Fn to 1.1 Fn in 0.001 Fn steps	1,1 Fn
<i>Time t_{18}</i>	This is the trip time of the protection; the value is given in seconds and can be set within a range: 0.06 s to 300 s, in 0.01 s steps	3 s

Limitations and additional functions

The block functions can also be accessed by means of the service connector (via Ekip Connect) or by connection to the system bus (page 76).

6 - Power protections

List The Power protections, available by default for the Ekip Hi-Touch, Ekip G Touch, Ekip G-Hi Touch and Ekip M Touch models and configurable in the remaining models as additional SW package, are:

Name	Type of protection	Page
RP	Reverse active power	61
D ⁽²⁾	Directional short-circuit with adjustable delay	64
OQ ⁽¹⁾	Maximum reactive power	64
OP ⁽¹⁾	Active overpower	64
UP ⁽¹⁾	Active underpower	65
RQ ⁽¹⁾⁽²⁾	Reverse reactive power	65
Cos φ	Minimum Cos φ	66

⁽¹⁾ protection not available by default with Ekip Hi-Touch and Ekip M Touch. However, it can be integrated by requesting the relative SW package

⁽²⁾ protection not available by default with Ekip G Touch. However, it can be integrated by requesting the relative SW package



WARNING! The Power flow parameters effect the sign of the power and power factor values measured by the unit. Power flow must be configured and verified on the basis of your installation to ensure that all the protections of the Power Protections package function correctly

RP Protection Function

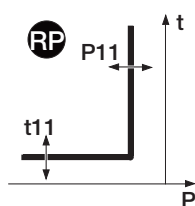

The protection sends a TRIP command if the reverse total active power exceeds threshold P11 for longer than t1.

To check and simulate the trip times in relation to all the parameters, please consult:

- summary table of the protections with the operating characteristics (page 82)
- the graph with trip curve (page 95)

Parameters

Parameter	Description	Default
<i>Enable</i>	Activates/deactivates the protection and its availability in the parameters menu	OFF
<i>Trip Enable</i>	Activates/deactivates transmission of the open command: if disabled, the alarm and exceedance of protection time are only managed as information	OFF
<i>Threshold P11</i>	Establishes the value that activates the protection. The value is given as both absolute value (kW) and relative value (Sn) and can be set within the range: -0.05 Sn to -1 Sn in 0.001 Sn steps  NOTE: the threshold expressed in Sn is preceded by the "-" sign to indicate that inverse power is involved	0,1 Sn
<i>Time t11</i>	This is the trip time of the protection; the value is given in seconds and can be set within a range: 0.05 s to 120 s, in 0.01 s steps	10 s

Limitations and additional functions

The block functions can also be accessed by means of the service connector (via Ekip Connect) or by connection to the system bus (page 76).

D Protection Function

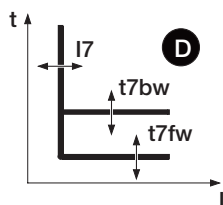

D protection is very similar to S protection, with the additional capability of recognizing the direction of the current during a fault.

The current direction allows the user to find out whether the fault is on the supply side or load side of the device controlled by Ekip Touch.

In ring type distribution systems, D protection allows the distribution section in which the fault has occurred to be identified and disconnected without affecting the rest of the installation (using zone selectivity).

Depending on the direction of the fault, if the current of one or more phases exceeds threshold $I7$ ($I7fw$ or $I7bw$) for longer than time $t7$ ($t7fw$ or $t7bw$), the protection activates and sends a TRIP command.

The **fault direction** is established by comparing the **detected fault current** with the **reference direction**.

i **NOTE:** the reference direction is calculated considering the set value of the power flow direction and the phase sequence (cyclic direction of the phases):

Phase sequence (set)	Power flow (set)	Phase sequence (detected)	Reference direction (forward direction)
123	High-->Low	123	High-->Low
123	Bottom --> Top	123	Bottom --> Top
123	High-->Low	321	Bottom --> Top
123	Bottom --> Top	321	High-->Low
321	High-->Low	123	Bottom --> Top
321	Bottom --> Top	123	High-->Low
321	High-->Low	321	High-->Low
321	Bottom --> Top	321	Bottom --> Top

To check and simulate the trip times in relation to all the parameters, please consult:

- the summary table of the protections with the calculation formulas (page 81)
- the graph with trip curve (page 95)

Parameter	Description	Default
<i>Enable</i>	Activates/deactivates the protection and its availability in the parameters menu	OFF
<i>Trip Enable</i>	Activates/deactivates transmission of the open command: if disabled, the alarm and exceedance of protection time are only managed as information	ON
<i>Threshold I7 Fw</i>	Establishes the value that activates the protection with forward direction. The value is given as both absolute value (amperes) and relative value (I_n) and can be set within the range: $0.6 I_n$ to $10 I_n$, in $0.1 I_n$ steps	$2 I_n$
<i>Threshold i7 Bw</i>	Establishes the value that activates the protection with backward direction. The value is given as both absolute value (amperes) and relative value (I_n) and can be set within the range: $0.6 I_n$ to $10 I_n$, in $0.1 I_n$ steps	$2 I_n$
<i>Time t7 Fw</i>	This is the trip time in the case of forward direction. The value is given in seconds and can be set within the range: 0.1 s to 0.8 s, in 0.01 s steps	0,2 s
<i>Time t7 Bw</i>	This is the trip time in the case of backward direction. The value is given in seconds and can be set within the range: 0.1 s to 0.8 s, in 0.01 s steps	0,2 s
<i>ZoneSelectivity</i> ⁽¹⁾	Activates/deactivates the function and selectivity time availability on the display. i NOTE: configure selectivities S, S2, I, 2I, MCR and G OFF to ensure that selectivity D functions correctly	OFF
<i>Selectivity time Fw</i> ⁽¹⁾	This is the trip time of the protection with the zone selectivity function activated, forward direction and selectivity input Fw not present. The value is given in seconds and can be set within the range: 0.1 s to 0.8 s, in 0.01 s steps	0,13 s
<i>Selectivity time Bw</i> ⁽¹⁾	This is the trip time of the protection with the zone selectivity function activated, backward direction and selectivity input Bw not present. The value is given in seconds and can be set within the range: 0.1 s to 0.8 s, in 0.01 s steps	0,13 s

Continued on the next page

Parameter	Description	Default
<i>StartUp enable</i>	Activates/deactivates the function and availability of the associated parameters on the display	OFF
<i>StartUp Threshold Fw⁽²⁾</i>	Protection threshold valid during Startup time, in the conditions in which the function is activated and with forward current direction ⁽²⁾ . The value is given as both absolute value (amperes) and relative value (In) and can be set within the range: 0.6 In to 10 In, in 0.1 In steps	2 In
<i>StartUp Threshold Bw⁽²⁾</i>	Protection threshold valid during Startup time, in the conditions in which the function is activated and with backward current direction. The value is given as both absolute value (amperes) and relative value (In) and can be set within the range: 0.6 In to 10 In, in 0.1 In steps	2 In
<i>StartUp Time⁽²⁾</i>	This is the time for which the StartUp threshold remains activated and is calculated from the moment the activation Threshold is exceeded. The value is given in seconds and can be set within the range: 0.1 s to 30 s, in 0.01 s steps	0.1 s
<i>Direction Min Angle</i>	Ekip Touch calculates the phase displacement angle between active and apparent power measured: when phase displacement exceeds the set Direction Min Angle parameter, the unit considers the fault direction to have been identified. The value is given in degrees and can be set within a range of 15 values from 3.6° to 69.6°	3,6 °

⁽¹⁾ details on page 74

⁽²⁾ details on page 76

Limitations and additional functions

the functions blocking the type of selectivity and the *Trip only Forward* and *Trip Only Backward* parameters can also be accessed by means of the service connector (via Ekip Connect) or communication via system bus (page 76).

Notes

- activation of D directional protection automatically activates the alarm that monitors phase sequence (which can also be excluded and activated in the manual mode): note how, in the case of a cyclic sequence of phases that differs from the set value, in the event of a fault the directional protection inverts the reference direction with respect to the expected direction; details of the phase sequence protection are available on page 53
- in the case of small overcurrents, the behavior of the directional protection is influenced by the type of load: to prevent the direction of the fault current from being incorrectly interpreted in the case of capacitive loads, it is advisable for the setting of that protection to be made on the basis of real fault conditions and not overloads

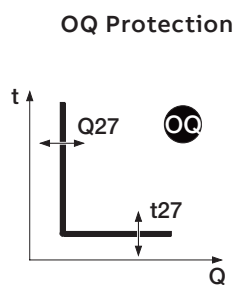
**Function**

The protection sends a TRIP command if one or more of the reactive power values detected by the unit exceed threshold Q27 for longer than t27.

To check and simulate the trip times in relation to all the parameters, please consult:

- summary table of the protections with the operating characteristics (page 82)
- the graph with trip curve (page 96)

Parameters

Parameter	Description	Default
<i>Enable</i>	Activates/deactivates the protection and its availability in the parameters menu	OFF
<i>Trip Enable</i>	Activates/deactivates transmission of the open command: if disabled, the alarm and exceedance of protection time are only managed as information	OFF
<i>Threshold Q27</i>	Establishes the value that activates the protection. The value is given as both absolute value (kVAR) and relative value (Sn) and can be set within the range: 0.4 Sn to 2 Sn in 0.001 Sn steps	1 Sn
<i>Time t27</i>	This is the trip time of the protection; the value is given in seconds and can be set within a range: 0.5 s to 100 s, in 0.5 s steps	1 s

Limitations and additional functions

The block functions can also be accessed by means of the service connector (via Ekip Connect) or by connection to the system bus (page 76).

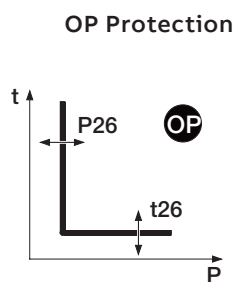
**Function**

The protection sends a TRIP command if one or more of the active power values detected by the unit exceed threshold P26 for longer than t26.

To check and simulate the trip times in relation to all the parameters, please consult:

- summary table of the protections with the operating characteristics (page 82)
- the graph with trip curve (page 96)

Parameters

Parameter	Description	Default
<i>Enable</i>	Activates/deactivates the protection and its availability in the parameters menu	OFF
<i>Trip Enable</i>	Activates/deactivates transmission of the open command: if disabled, the alarm and exceedance of protection time are only managed as information	OFF
<i>Threshold P26</i>	Establishes the value that activates the protection. The value is given as both absolute value (kW) and relative value (Sn) and can be set within the range: 0.4 Sn to 2 Sn in 0.001 Sn steps	1 Un
<i>Time t26</i>	This is the trip time of the protection; the value is given in seconds and can be set within a range: 0.5 s to 100 s, in 0.5 s steps	1 s

Limitations and additional functions

The block functions can also be accessed by means of the service connector (via Ekip Connect) or by connection to the system bus (page 76).

UP Protection Function

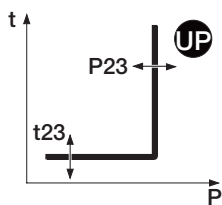

The protection sends a TRIP command if one or more of the active power values detected by the unit drop below threshold P23 for longer than t23.

The protection is active also for negative (reverse) active power, but is independent from the RP protection (Reverse active power protection).

The protection excludes itself if the maximum value of the line-to-line voltage is less than 30 V.

To check and simulate the trip times in relation to all the parameters, please consult:

- summary table of the protections with the operating characteristics (page 82)
- the graph with trip curve (page 97)

Parameter	Description	Default
<i>Enable</i>	Activates/deactivates the protection and its availability in the parameters menu	OFF
<i>Trip Enable</i>	Activates/deactivates transmission of the open command: if disabled, the alarm and exceedance of protection time are only managed as information	OFF
<i>Threshold P23</i>	Establishes the value that activates the protection. The value is given as both absolute value (kW) and relative value (Sn) and can be set within the range: 0.1 Sn to 1 Sn in 0.001 Sn steps	1 Sn
<i>Time t23</i>	This is the trip time of the protection; the value is given in seconds and can be set within a range: 0.5 s to 100 s, in 0.5 s steps	1 s
<i>StartUp enable</i>	Activates/deactivates the function and availability of the StartUp Time parameter in the menu	OFF
<i>StartUp Time</i>	This is the time for which the threshold remains disabled and is calculated from the moment the activation Threshold is exceeded. The value is given in seconds and can be set within the range: 0.1 s to 30 s, in 0.01 s steps	0.1 s

Limitations and additional functions

The block functions can also be accessed by means of the service connector (via Ekip Connect) or by connection to the system bus (page 76).

RQ Protection Function

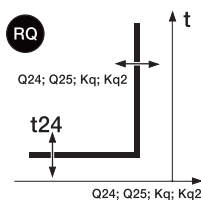

RQ protection protects against reactive power reversal; the threshold can be adjusted on the basis of the active power.

The protection sends a TRIP command when inverse reactive power enters the TRIP area, determined by the protection parameters and power value readings, for longer than t24.

Adjustment of constants Kq and Kq2 allows the trip threshold of the protection (determined by the intersection of the two TRIP areas, whose limits depend on the parameters configured in the unit) to be changed.

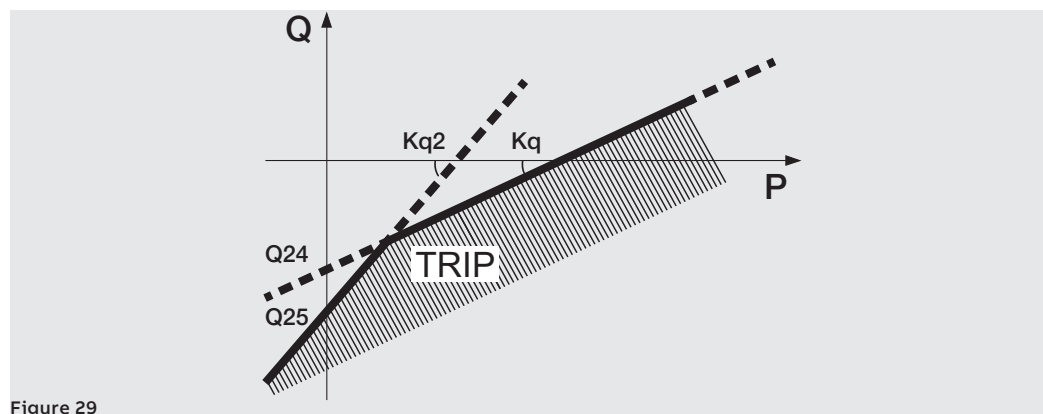



Figure 29

To check and simulate the trip times in relation to all the parameters, please consult:

- summary table of the protections with the operating characteristics (page 82)
- the graph with trip curve (page 97)

Continued on the next page

Parameters

Parameter	Description	Default
<i>Enable</i>	Activates/deactivates the protection and its availability in the parameters menu	OFF
<i>Trip Enable</i>	Activates/deactivates transmission of the open command: if disabled, the alarm and exceedance of protection time are only managed as information	OFF
<i>Threshold Kq</i>	Defines the gradient of the line relating to threshold Q24. The value is given as absolute value (slope of the line) and can be set within the range: -2 to 2 in 0.01 steps	-2
<i>Threshold -Q24</i>	This is the reactive power required to define the trip line and relative TRIP area. The value is given as both absolute value (kVAR) and relative value (Sn) and can be set within the range: 0.1 Sn to 1 Sn in 0.001 Sn steps  NOTE: the threshold expressed in Sn is not preceded by the “-” sign, but should still be understood as inverse reactive power	0,1 Sn
<i>Threshold Kq2</i>	Defines the gradient of the line relating to threshold Q25. The value is given as absolute value (slope of the line) and can be set within the range: -2 to 2 in 0.01 steps	2
<i>Threshold -Q25</i>	Defines the reactive power value at which the protection trips and is required for the purpose of defining the relative TRIP area The value is given as both absolute value (kVAR) and relative value (Sn) and can be set within the range: 0.1 Sn to 1 Sn in 0.001 Sn steps  NOTE: the threshold expressed in Sn is not preceded by the “-” sign, but should still be understood as inverse reactive power	0,11 Sn
<i>Time t24</i>	This is the trip time of the protection; the value is given in seconds and can be set within a range: 0.5 s to 100 s, in 0.1 s steps	100 s
<i>Threshold Vmin</i>	It is the minimum voltage for activation of the protection. If there is at least one line-to-line voltage present below the Vmin threshold, the protection is not active. The value is given as both absolute value (V) and relative value (Un) and can be set within the range: 0.5 Un to 1.2 Un in 0.01 Un steps	0.5 Un

Limitations and additional functions

- Ekip Touch accepts parameters in accordance with the following limitations: $Q24 < Q25$ and $Kq < Kq2$
- the block functions can also be accessed by means of the service connector (via Ekip Connect) or by connection to the system bus (page 76).

Cos φ Protection The protection activates an alarm when the total Cos φ value drops below the set threshold.
Total cos φ is calculated as ratio between total active power and total apparent power.

Parameters

The parameters are available in the *Advanced - Signaling menu* (page 33)

Parameter	Description	Default
<i>Enable</i>	Activates/deactivates the protection and availability of the threshold in the menu	OFF
<i>Threshold</i>	Defines the value that activates the protection; can be set within the range: 0.5 to 0.95 in 0.01 steps	0,95

7 - ROCOF protections

The ROCOF Protection package is available by default for Ekip G Hi-Touch and configurable in the remaining models as additional SW package

The protection is described below:

ROCOF Protection

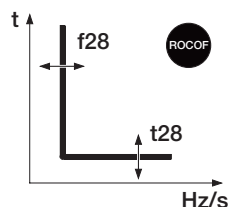

Function

ROCOF protection protects against rapid frequency variations: the protection sends a TRIP command if the frequency changes faster than control variation f_{28} set in the unit for longer than t_{28} .

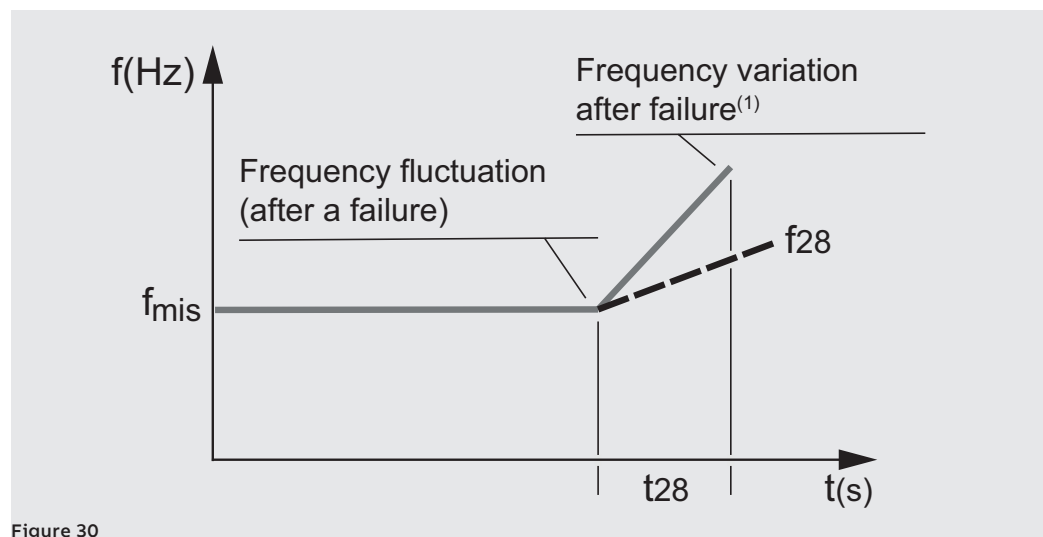

Figure 30

⁽¹⁾ example with positive linear variation of the higher frequency of the set f_{28} value; the protection also manages negative variations

The protection excludes itself if the maximum value of the line-to-line voltage is less than 30 V.

To check and simulate the trip times in relation to all the parameters, please consult:

- summary table of the protections with the operating characteristics (page 83)
- the graph with trip curve (page 98)

Parameters

Parameter	Description	Default
<i>Enable</i>	Activates/deactivates the protection and its availability in the parameters menu	OFF
<i>Trip Enable</i>	Activates/deactivates transmission of the open command: if disabled, the alarm and exceedance of protection time are only managed as information	OFF
<i>Threshold f_{28}</i>	establishes the maximum admissible frequency variation rate over time; the protection trips if this rate is exceeded. The value is given as absolute value (Hz/s) F_n and can be set within the range: 0.4 Hz/s to 10 Hz/s in 0.2 Hz/s steps	0,6 Hz/s
<i>Trip Direction</i>	Establishes whether the protection monitors an increase (Up), a decrease (Down) or both variations (Up and Down)	Up or Down
<i>Time f_{28}</i>	This is the trip time of the protection; the value is given in seconds and can be set within a range: 0.06 s to 300 s, in 0.01 s steps	0,5 s

Limitations and additional functions

The block functions can also be accessed by means of the service connector (via Ekip Connect) or by connection to the system bus (page 76).

8 - Protection Adaptive

The Adaptive Protection package is available by default for Ekip Hi-Touch, Ekip M Touch and Ekip G Hi-Touch and configurable in the remaining models as additional SW package.

The protection is described below:

Dual Set The function enables two different protection configurations to be made, one as an alternative to the other, by means of a set change with programmable events.

The function can be activated in the *Settings-Dual Set* menu (page 35)

Parameter	Description	Default
<i>Enable</i>	Activates/deactivates the function	OFF
<i>Default Set</i>	Defines the sets of main and secondary protections (which activate in the presence of the programmed event)	Set A

The event that determines set change (from default to secondary) can be programmed in the *Advanced-Functions* menu, see the paragraph Programmable Functions and Commands (page 78).

9 - Motor protections

List The Motor Protection package, available by default and only for Ekip M Touch, comprises protections:

Name	Type of protection	Page
R JAM	Motor block (post startup)	70
R STALL	Motor block (always activated)	70
UC	Under-current	71
U	Phase loss	71
PTC	Maximum temperature	72

The Motor protections conform to standard IEC 60947-4-1 and relative annex 2.

Trip class and parameters The trip class mentioned in standard IEC 60947-4-1 is available in Trip units with Motor Class parameter (page 121).

Its value establishes:

- the trip time of L protection (*Time t1*)
- the start-up time (*Motor start-up*), calculated from the moment that at least one phase exceeds the fixed threshold of $0.25 \times I_1$, during which some protections are inhibited
- the thermal memory L reset time after a TRIP (*tmem res*)

Motor Class	t1 (s)	Motor start-up (s)	tmem res (min)
5E	12	3	5
10E	22	5	10
20E	45	10	20
30E	72	20	33

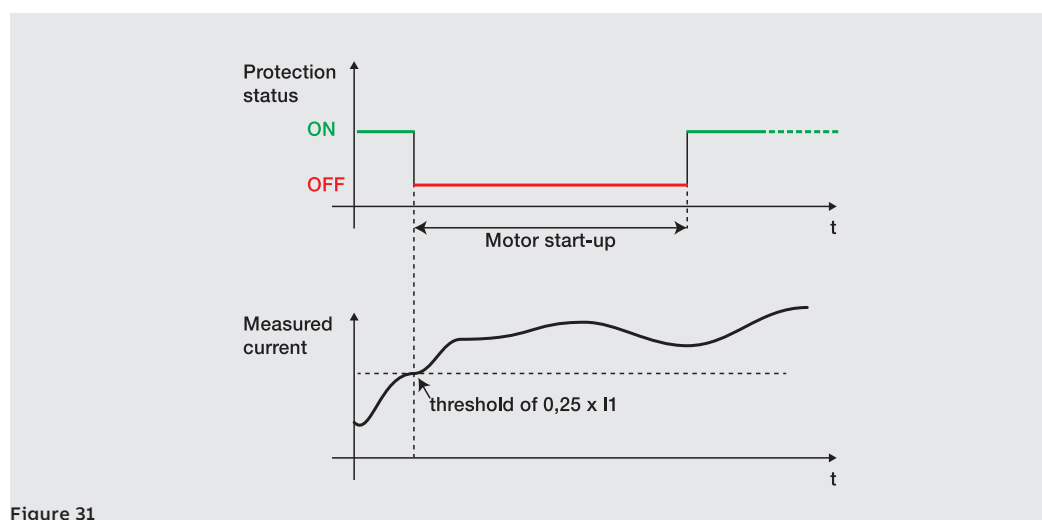

Figure 31

i **NOTE:** temporary switch-off during Motor Start-up is valid and activated for protections G, R Jam and U if enabled; if the protections are disabled they remain off before and after Motor Start-up.

Thresholds Unlike the other current protections, the R Stall, R Jam and UC thresholds are not related to I_n , but to threshold I_1 (L protection), given as I_r in the respective configuration menus;

Example

Rating plug = 400 A, Threshold $I_1 = 0.8 I_n$ (--> 320 A); Threshold $I_j = 2.5 I_r$ (--> $2.5 \times 320 \text{ A} = 800 \text{ A}$)

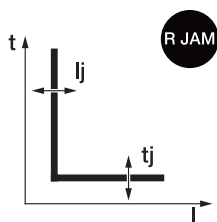
Protection R JAM**Function**

R Jam is a protection against motor block: if the current of one or more phases exceeds threshold I_j for longer than time t_j , the protection activates and sends a TRIP command.

The R Jam protection is inhibited during *Motor start-up*.

To check and simulate the trip times in relation to all the parameters, please consult:

- the summary table of the protections with the calculation formulas (page 83)
- the graph with trip curve (page 98)

Parameters

Parameter	Description	Default
<i>Enable</i>	Activates/deactivates the protection and its availability in the parameters menu	OFF
<i>Trip Enable</i>	Activates/deactivates transmission of the open command: if disabled, the alarm and exceedance of protection time are only managed as information	OFF
<i>Threshold I_j</i>	Establishes the value that activates the protection. The value is given as both absolute value (amperes) and relative value (I_r) and can be set within the range: 1 I_r to 10 I_r in 0.1 I_r steps	1,0 I_r
<i>Time t_j</i>	This is the trip time of the protection; the value is given in seconds and can be set within a range: 2 s to 10 s, in 0.5 s steps	2 s

Limitations and additional functions

The block functions can also be accessed by means of the service connector (via Ekip Connect) or by connection to the system bus (page 76).

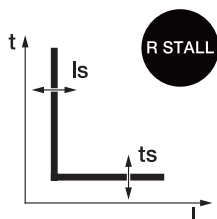
Protection R STALL**Function**

R Stall protects against motor block, but unlike R Jam, it is not inhibited during *Motor startup-up*: if the current of one or more phases exceeds threshold I_s for longer than time t_s , the protection activates and sends a TRIP command.

To check and simulate the trip times in relation to all the parameters, please consult:

- the summary table of the protections with the calculation formulas (page 83)
- the graph with trip curve (page 99)

Parameters

Parameter	Description	Default
<i>Enable</i>	Activates/deactivates the protection and its availability in the parameters menu	OFF
<i>Trip Enable</i>	Activates/deactivates transmission of the open command: if disabled, the alarm and exceedance of protection time are only managed as information	OFF
<i>Threshold I_s</i>	Establishes the value that activates the protection. The value is given as both absolute value (amperes) and relative value (I_r) and can be set within the range: 2 I_r to 10 I_r in 0.1 I_r steps	2,0 I_r
<i>Time t_s</i>	This is the trip time of the protection; the value is given in seconds and can be set within a range: 1 s to 10 s, in 0.5 s steps	1 s

Limitations and additional functions

The block functions can also be accessed by means of the service connector (via Ekip Connect) or by connection to the system bus (page 76).

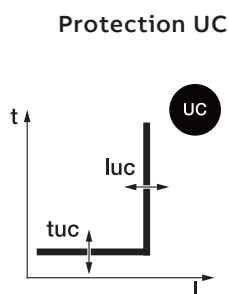
**Function**

UC protects the motor in reduced or no load conditions: the protection sends a TRIP command if all the current values detected by the unit drop below threshold I_{uc} for longer than time t_{uc} .

To check and simulate the trip times in relation to all the parameters, please consult:

- summary table of the protections with the operating characteristics (page 83)
- the graph with trip curve (page 99)

Parameters

Parameter	Description	Default
<i>Enable</i>	Activates/deactivates the protection and its availability in the parameters menu	OFF
<i>Trip Enable</i>	Activates/deactivates transmission of the open command: if disabled, the alarm and exceedance of protection time are only managed as information	OFF
<i>Threshold I_{uc}</i>	Establishes the value that activates the protection. The value is given as both absolute value (amperes) and relative value (I_r) and can be set within the range: $0.5 I_r$ to $0.9 I_r$ in $0.1 I_r$ steps	$0,5 I_r$
<i>Time t_{uc}</i>	This is the trip time of the protection; the value is given in seconds and can be set within a range: 1 s to 20 s, in 0.5 s steps	1 s

Limitations and additional functions

The block functions can also be accessed by means of the service connector (via Ekip Connect) or by connection to the system bus (page 76).

Protection U**Function**

U protects the motor in the event of phase loss: the protection sends a TRIP command if the rms value of at least one phase drops below the $0.1 I_n$ threshold and, at the same time, a current exceeds $0.25 I_n$ for longer than time t_u ; the protection is inhibited during *Motor start-up*.

If an alarm due to U protection occurs during *Motor start-up*, the trip unit calculates the trip time of the protection using whichever is the lowest value between: t_u and half of *Motor start-up*



IMPORTANT: in this case, if the alarm occurs on start-up and the calculated TRIP time is sufficiently long to last even until the Motor start-up window closes, the trip unit still considers the previously calculated minimum value as TRIP time

To check and simulate the trip times in relation to all the parameters, please consult the summary table of the protections with the operating characteristics (page 83)

Parameters

Parameter	Description	Default
<i>Enable</i>	Activates/deactivates the protection and its availability in the parameters menu	OFF
<i>Trip Enable</i>	Activates/deactivates transmission of the open command: if disabled, the alarm and exceedance of protection time are only managed as information	OFF
<i>Time t_u</i>	This is the trip time of the protection; the value is given in seconds and can be set within a range: 1 s to 10 s, in 0.5 s steps	1 s

Limitations and additional functions

The block functions can also be accessed by means of the service connector (via Ekip Connect) or by connection to the system bus (page 76).

PTC Protection Function

PTC protects the motor against overtemperatures.

The Trip unit receives the alarm from the *Ekip CI* module to which a thermocouple can be connected for the purpose of monitoring the temperature of the motor: the protection sends a TRIP command if the temperature measured exceeds 120 °C for more than one second.

Parameters

Parameter	Description	Default
<i>Enable</i>	Activates/deactivates the protection and its availability in the parameters menu	OFF
<i>Trip Enable</i>	Activates/deactivates transmission of the open command: if disabled, the alarm and exceedance of protection time are only managed as information	OFF

10 - Additional protections and functions

Introduction Some protections have additional functions which extend their characteristics and performance:

Name	Type of protection	Page
Thermal Memory	overheating of the cables	73
Zone selectivity	management of trip commands in a network of circuit-breakers	73
Blocks	blocking of protection on the basis of programmable events	76
Startup	different thresholds on the basis of monitoring thresholds	76
Current thresholds	Current control with programmable thresholds	77
Programmable Commands	Programmable commands with trip unit events or statuses	78

The presence of *Ekip Synchrocheck* allows the protections of the module to be activated (page 78)

Thermal Memory Protection The function, which is available for L and S protections, allows overheating in the cables connected to the circuit-breaker to be prevented: in the case of trips within brief intervals, the unit considers the time between commands and the entity of the faults so as to reduce opening time.



IMPORTANT: for the S protection the function can be activated if the selected curve is time-dependent.



NOTE: the function also reduces the trip time in the case of overloads which have not led to the open command (longer than 100 ms)

S, S2, I, 2I, MCR, G zone selectivity Protection The function, which can be activated for S, S2, I, 2I, MCR and G protections (if available and enabled), allows several devices belonging to the same installation (including Ekip Touch) to be interconnected, so as to handle trip commands in the best possible way in the case of S, S2, I, 2I, MCR and G protections.

The function allows the devices to be coordinated so that, if a fault occurs:

- the device nearest to the fault trips
- the other devices are blocked for a programmable time



NOTE: connection can be made between ABB devices that have the zone selectivity function

Characteristics

Ekip Touch has five selectivity connections, located on the rear connectors of the CB:

Name	Type	Description	Connection
Szi	Input	S, S2, I, 2I and MCR protection selectivity input	From devices on the load side
Szo	Output	S, S2, I, 2I and MCR protection selectivity output	To devices on the supply side
Gzi	Input	G protection selectivity input	From devices on the load side
Gzo	Output	G protection selectivity output	To devices on the supply side
Szc	Common	Common connection of selectivity network	The entire selectivity network

Continued on the next page

Configuration

To correctly configure the selectivity network of one or more protections:

1. Connect zone selectivity outputs of the same type (example: Szo) of devices belonging to the same zone, to the zone selectivity input of the device immediately upstream (example: Szi).
2. Connect all the Szc of devices in the same network together.
3. Time t2 must be configured at t2 sel + 50 ms or more, with the exclusion of the device further along its network.

Logic table

The table includes all cases in which, with zone selectivity enabled in the device, an alarm condition occurs or a zone selectivity signal is received from another device.



NOTES:

- the table gives the S protection cases, but is also valid for the other protections: G, S2, I, 2I and MCR, each with its respective connections
- if the selectivities of protections that share the same connections are active at the same time (example: S, S2, I, 2I and MCR), the inputs/outputs are managed with OR logic

Condition	Szi	Szo	Tripping time	Remarks
If < I2	0	0	No TRIP	TRIP II device not in alarm status
If < I2	1	1	No TRIP	The device is not in the alarm status, but sends the selectivity signal received from the device upstream
If > I2	0	1	t2 sel ⁽¹⁾	The device is in the alarm status and is the first to detect the fault: trips within time t2 sel ⁽¹⁾
If > I2	1	1	t2 ⁽²⁾	The device is in the alarm status but is not the first to detect the fault: trips within time t2 ⁽²⁾

D zone selectivity Protection Foreword

This function, which can be activated for D protection (if available and enabled), enables devices belonging to the same installation (including Ekip Touch) to be connected together so as to handle the trip commands in a better way in the case of D protection.

It is especially useful in ring and grid type systems where, besides the zone, it is essential to also define the direction of the power flow that supplies the fault.

The function allows the devices to be coordinated so that, if a fault occurs:

- The device nearest to the fault trips
- The other devices are blocked for a programmable time



NOTES:

- connection can be made between ABB devices that have the zone selectivity function
- disable the zone selectivities of protections S, S2, I, 2I, MCR and G to correctly use the selectivity D function

Characteristics

Ekip Touch has five selectivity connections, located on the rear connectors of the CB:

Name	Type	Description	Denomintion for D
Szi	Input	Forward direction selectivity input	DFin
Szo	Output	Forward direction selectivity output	DFout
Gzi	Input	Backward direction selectivity input	Dbin
Gzo	Output	Backward direction selectivity output	Dbout
Szc	Common	Common connection of selectivity network	SZc

Continued on the next page

Configuration

To correctly configure selectivity D in a ring system:

1. Connect the zone selectivity outputs of each device (example: DFin) to the selectivity input of the same direction as the device immediately after (example: DFout).
2. Connect all the Szc of devices in the same network together.

Logic table

The table includes all cases in which, with zone selectivity enabled in the device, an alarm condition occurs or a zone selectivity signal is received from another device.

The Forward output is activated if the **fault direction** coincides with the **reference direction** otherwise, if it is in the opposite direction, the Backward output is activated (page 62)

Fault direction	Condition	DFin	Dbin	Dfout	Dbout	Tripping time	Remarks
Forward	If < I7 Fw	0	x	0	x	No TRIP	Device not in alarm status
Backward	If < I7 Bw	x	0	x	0		
Forward	If < I7 Fw	1	x	1	x	No TRIP	The device is not in the alarm status, but sends the selectivity signal received to the output of the reference direction
Backward	If < I7 Bw	x	1	x	1		
Forward	If > I7 Fw	0	x	1	x	t7 Fw sel	The device is in the alarm status and is the first to detect the fault: trips within time t7 Fw sel or t7 Bw sel
Backward	If > I7 Bw	x	0	x	1	t7 Bw sel	
Forward	If > I7 Fw	1	x	1	x	t7 Fw	The device is in the alarm status but is not the first to detect the fault: trips within time t7 Fw (or t7 Bw)
Backward	If > I7 Bw	x	1	x	1	t7 Bw	



NOTE: when zone selectivity is active and the direction of the fault cannot be established, the unit trips by considering the first threshold to be exceeded between I7 Fw and I7 Bw, without activating any output (DFout or Dbout); if both the thresholds have been exceeded (for example, if they have been set with the same value), the unit trips after the shortest time between t7 Fw and t7 Bw.

Trip Only Forward and Backward

D protection can be configured (if available and enabled) with 2 additional parameters via the service connector (via Ekip Connect) or via system bus communication:

- *Trip only Forward:* if activated, D protection only controls open commands if forward direction is detected
- *Trip only Backward:* if activated, D protection only controls open commands if backward direction is detected

faults in the opposite direction are only handled as alarm information.

Type of selectivity

The zone selectivity inputs and certain of the outputs can be configured via service connector (via Ekip Connect) or via system bus communication for protections S, S2, I, 2I, MCR, G and D (if available and enabled):

- *Standard:* operation as by zone selectivity standard logic (default configuration)
- *Customized:* the event that activates the zone selectivity input or output can be selected in this mode.



IMPORTANT: in the Customized configuration, the only zone selectivity activation event is the one set and standard selectivity operation is therefore not active (changes should only be made by expert technical personnel).

Startup Protection The function, which can be activated for protections S, I, G, S2, D and UP (if available and enabled), allow the protection threshold (*Startup threshold*) to be changed for a period that can be set by the user (Startup time).

i **NOTE:** for UP protection, startup means the time for which the protection is disabled

The period begins after a threshold has been exceeded (activation threshold), user-programmable via Ekip Connect or system bus, valid and verified for all phase currents.

The Startup condition elapses after Startup time and re-activates the next time the activation threshold is exceeded

i **NOTE:** startup does not occur again until at least one current remains above activation threshold level

A graphic representation with S protection follows:

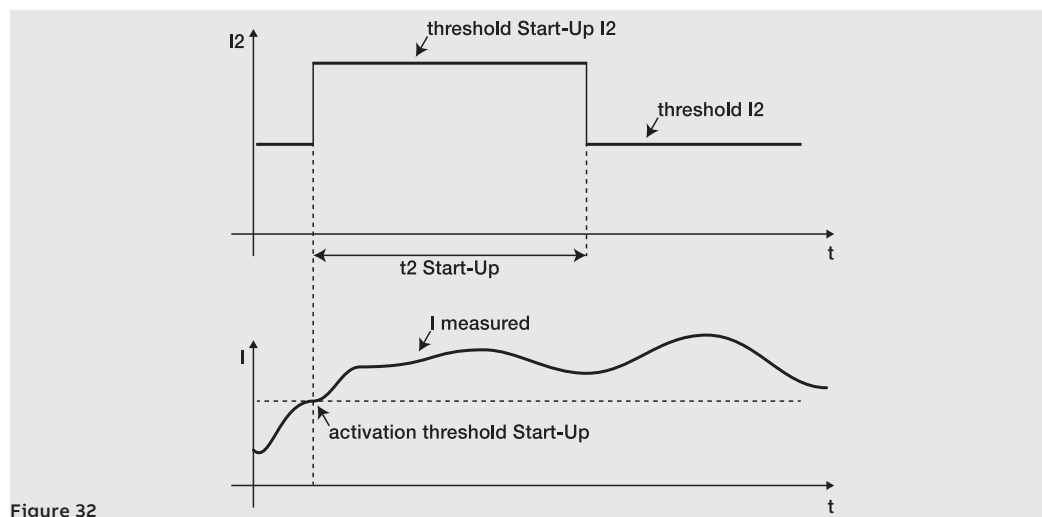

Figure 32

Block functions Six blocks can be configured for certain protections by means of the service connector (via Ekip Connect) or communication via system bus. These blocks are useful for deactivating the protections relating to programmable events:

Block name	Description
BlockOnProgStatusA	Block active if programmable status A is true
BlockOnProgStatusB	Block active if programmable status B is true
BlockOnProgStatusC	Block active if programmable status C is true
BlockOnProgStatusD	Block active if programmable status D is true
BlockOnStartup	Block active during StartUp time (if StartUp for the specific protection is available and activated)
BlockOnOutOfFrequency	Block active if frequency measured is not within 30 Hz to 80 Hz range

Each block is independent and has its own activation command (Block On); however, each protection can be configured with several block conditions (operation in OR logic condition).

The protections which have blocks are: S, I, G, MCR, S2, D, S(V), S2(V), UV, OV, VU, UV2, OV2, UP, OP, RP, RQ, OQ, RV, UF, OF, UF2, OF2, ROCOF, UC, U, R Jam, R Stall.

! **IMPORTANT: the blocks can cause:**

- increase of protection trip times (max: + 30 ms), owing to verification of the event itself (example: (frequency check))
- undesired deactivation of the protection, if the block is associated with statuses or signals to modules via local bus and auxiliary power supply is absent. In this case, it may be useful to also consider the status of the auxiliary power supply (Supply from Vaux) when programming the event
- undesired deactivation of the protection, if the block is associated with frequency measurements and the voltage is less than the minimum calculation threshold

! **IMPORTANT: if the function is activated, the blocks are deactivated during startup (except for BlockOnStartup, which functions during this period)**

Current thresholds Function

The Current thresholds allow checks to be set along the current lines, to be associated with the programmable contacts of the *Ekip Signalling* modules (in all versions).

Two pairs of programmable contacts are available:

- Threshold 1 I1 and Threshold 2 I1, with control relating to I1
- Threshold Iw1 and Threshold Iw2, with control relating to In

The thresholds can be enabled and set in the Advanced - Signaling menu (page 33).



IMPORTANT:

- the current thresholds do not handle the trip, just the signal
- the function is activated if the trip unit is powered by auxiliary voltage

Parameters

Threshold	Available parameters	Default
Threshold 1 I1	<i>Enable</i> : Activates the protection and availability of the threshold in the menu	OFF
	<i>Threshold</i> : The value is given in percentage of threshold I1 and can be set within the range: 50% I1 to 100% I1, in 1% steps.	50 % I1
Threshold 2 I1	<i>Enable</i> : Activates the protection and availability of the threshold in the menu	OFF
	<i>Threshold</i> : The value is given in percentage of threshold I1 and can be set within the range: 50% I1 to 100% I1, in 1% steps.	75 % I1
Threshold Iw1	<i>Enable</i> : Activates the protection and availability of the threshold in the menu	OFF
	<i>Direction</i> : allows the user to choose whether to have the signal when the current is higher (Up) or lower (Down) than the threshold.	Down
	<i>Threshold</i> : The value is given as both absolute value (amperes) and relative value (In) and can be set within the range: 0.1 In to 10 In, in 0.01 In steps	3 In
Threshold Iw2	<i>Enable</i> : Activates the protection and availability of the threshold in the menu	OFF
	<i>Direction</i> : allows the user to choose whether to have the signal when the current is higher (Up) or lower (Down) than the threshold.	Up
	<i>Threshold</i> : The value is given as both absolute value (amperes) and relative value (In) and can be set within the range: 0.1 In to 10 In, in 0.01 In steps	3 In

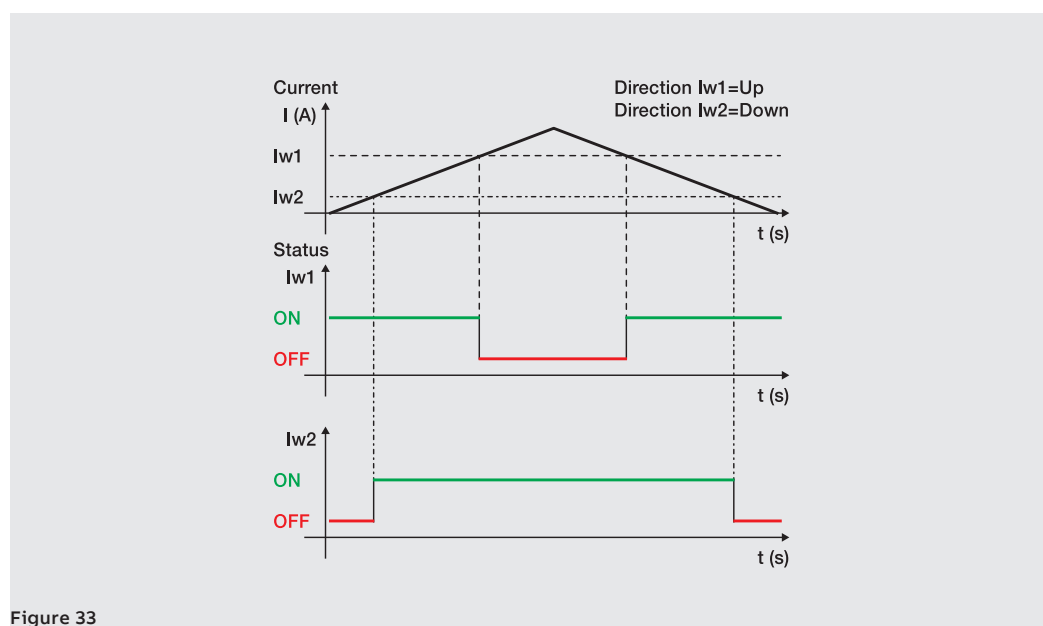

Figure 33

Synchrocheck With regard to closing the interconnection switch, the *Ekip Synchrocheck* module recognizes and reports whether there are synchronism conditions between two independent voltage sources (example: generator + grid).

A description of the module, the protection function and performance is given in the chapter dedicated to the modules (page 167).

Programmable Functions and Commands Eight commands are available, with activation that can be programmed on the basis of signals or events. Distributed among different Ekip Touch menus, the commands are:

Name	Description	Path (page)
External Trip	Sends a TRIP command	Advanced - Functions (33)
Trip RESET	Reset of the trip signal	
Turn on SET B	Changes the protections set, from Set A to Set B	
2I Mode	It activates 2I protection, if configured for this function	Advanced - Functions - 2I Menu (48)
RESET Energy	Resets the energy meters	Measurements - Energy (34)
YO Command	Sends an open command ⁽¹⁾	Settings - Functions (35)
YC Command	Sends a close command ⁽¹⁾	
LOCAL Switch On	Changes the configuration, from Remote to Local	Settings - Modules - Functions (35)
Signaling RESET	Reset the contacts of the signalling modules	

⁽¹⁾ the MOE-E storage command must be present

Parameters

Each command provides two programming parameters:

Parameter	Description	Default
Function	Event or several command activation events (up to eight, in AND or OR logic configuration). The Custom configuration can be programmed via Ekip Connect.	Deactivated
Delay	This is the minimum time the expected event must be present in order to activate the command; the value is given in seconds and can be set within a range: 0 s to 100 s, in 0.1 s steps	0 s



IMPORTANT: the commands are sent if all the operating conditions expected by the unit are present (connections, power supplies, alarms, etc.)

11 - Logic selectivity

Presentation Zone Selectivity via Link Bus is indicated as Logic Selectivity.

Logic Selectivity can be actuated for up to 12 of 15 actors that can be associated with Ekip Touch via Link Bus (see *Ekip Link* module, page 155).

Parameters

The function enabling parameter, available from among the parameters that can be set for the protection, must be set for each protection for which Zone Selectivity must be activated.

In this case, in addition to these parameters, Selectivity time is also activated for the setting.

Otherwise, Zone Selectivity can only be set up via the Ekip Connect software.



NOTE: *all the following parameters and configurations are available via Ekip Connect, with Ekip Link connected and on*

Setting Certain parameters can be configured in the *Ekip Link configuration* page:

- selection of selectivity type: hardware or mixed (hardware and logic)
- entry of the IP address of each actor present; entry of the address enables the configuration parameters and status indicators to be displayed in the various pages
- the function must be enabled for each actor associated with Ekip Touch via Link Bus and for which logic selectivity must be actuated (the *Actor Selectivity* parameter must be given value: *True*)

selectivity masks are available in the *Ekip Link advanced selectivity* page for each actor present: the mask allows the protections of the actors (S, I, 2I, MCR, G, D-Forward, D-Backward, S2) that activate the selectivity input of Ekip Touch to be selected (example: actor 1, protection mask S= S2: selectivity S of Ekip Touch will be active in the presence of signals S2 of actor 1).

In this configuration, if the function is enabled for S protection and is in the alarm status, the S/D-Forward hardware block signal and the logic selectivity S bit are activated on the output; depending on the block signals:

- if, on the input, the S/D-Forward hardware block signal and the logic selectivity S2 bit of actor 1 is not activated, the open command is sent in accordance with the selectivity time set for S protection
- a time equal to the trip time of S protection is waited if, on the input, the S/D-Forward hardware block signal is activated or mixed selectivity has been selected and the S2 logic selectivity bit of actor 1 is activated (and the open command is only sent if S protection is still in the alarm status once this time has elapsed)



NOTES:

- *the logic selectivity bits on the output and on the input are those in the data packages shared by the releases via Link Bus*
- *the S/D-Forward (G/D-Backward) hardware output is only activated if the S or D-Forward (G or D-Backward) protections are in the alarm status, and the S/DForward (G/D-Backward) hardware input only acts as a block for the S and D-Forward (G and D-Backward) protections, regardless of whether solely hardware or mixed selectivity has been selected*



IMPORTANT: if solely hardware selectivity has been selected, the logic selectivity bits are ignored on the input, but are still activated on the output

Selectivity masks

Remote Programmable States A and B are also included in the **selectivity masks**: these 2 parameters, which are available in the *Ekip Link configuration* page, enable the event (or combination of several events) and reference actor that activates the selectivity input to be selected.

2 further states are available, *C* and *D*, but they cannot be configured for Zone Selectivity. All 4 programmable states are used for the Programmable Logic function (see *Ekip Link* module on page 155).



NOTE: *the Programmable Logic function is independent from that of Zone Selectivity*

Repetition The **Repeat Configuration mask** parameter is available in the *Ekip Link advanced selectivity* page. It enables the selection of protections whose logic selectivity bit, if present on the input, must be propagated regardless of the status of the protection on the current unit.



NOTE: *the parameter only acts on the selectivity bits. It does not involve the outputs*

Diagnostic In the presence of both hardware and logic *Selectivity*, the *diagnosis* highlights any errors in the hardware *Selectivity* cabling by checking its continuity.

The *Ekip Link diagnosis configuration* page allows you to: enable diagnosis, configure the interval of time between one inspection and the next, select the inputs to be checked for each active actor (S/D_Forward, G/D_Backward).

Then:

- the hardware inputs are checked at regular intervals
- if, in Ekip Touch, the input of an actor is configured for diagnosis (e.g. input S of actor 3) and this input is not active when the test is performed, the actor stimulates its output (e.g. actor 3 activates output S) for a short time: Ekip Touch considers the test result to be positive if it receives the signal correctly at its input, otherwise it will signal error
- the diagnosis check will not be performed if the hw input is active: if the input configured for diagnosis is active when the test is performed, diagnosis check will not be performed and the **Detection state** parameter in the *Ekip Link state* page will indicate: Unknown

Errors and inconsistencies Regardless of the diagnosis, if a hardware input is active and none of the logic selectivity bits of the associated actors is active, a line inconsistency for this input is reported in the *Ekip Link state* page.



NOTE: *line inconsistency is ascertained by checking all the actors associated with the unit, even those for which the function has not been enabled (the Selectivity Actor parameter has not been assigned value: True)*

A line inconsistency (independent of diagnosis) is indicative of a possible configuration error (example: a hardware input of the release is connected to the hardware output of a device not associated via Link Bus, or of an actor for which the function has not been enabled).

- to prevent a line inconsistency from being signaled, devices whose hardware outputs are connected to the hardware inputs of Ekip Touch must also be connected to the Link Bus and associated with Ekip Touch, while the function need not be enabled for them (the Selectivity Actor parameter need not be assigned value: *True*)
-

12 - Performance table

- General notes:**
- The performance values given in the next table are valid with $\Delta 100$ ms trip time, temperature and signals within the operating limits; failure to comply with these limitations could lead to an increase in the tolerances.
 - Ekip Touch sends the TRIP command if the signal read exceeds the threshold for longer than the set time (or the time resulting from the calculation formula)
 - With an inverse time-delay trip curve, the calculation refers to a signal with a constant value throughout the timing; variation of the alarm signal causes a different trip time
 - The additional notes are given after all the tables

Standard Protections

Protection [ANSI code]	Trip time t_t ⁽¹⁾	Trip threshold tolerance ⁽³⁾	Trip time tolerance ⁽³⁾
L [49]	$t_t = \frac{t1 \times 9}{\left(\frac{If}{I1}\right)^2}$ (with curve $t = k / I^2$) $t_t = \frac{t1 \times a \times b}{\left(\left(\frac{If}{I1}\right)^k - 1\right)}$ (with curves 60255-151)	Activation for I_f within range: $(1.05 \text{ to } 1.2) \times I1$	with $I_f \leq 6 I_n$: $\pm 10\%$ / with $I_f > 6 I_n$: $\pm 20\%$
S [50TD / 51]	$t_t = t2$ (with curve $t = k$) $t_t = \frac{t2 \times 100}{If^2}$ (with curve $t = k / I^2$)	with $I_f \leq 6 I_n$: $\pm 7\%$ / with $I_f > 6 I_n$: $\pm 10\%$	The best between $\pm 10\%$ and 40 ms with $I_f \leq 6 I_n$: $\pm 15\%$ / with $I_f > 6 I_n$: $\pm 20\%$
S2 [50TD]	$t_t = t5$	with $I_f \leq 6 I_n$: $\pm 7\%$ / with $I_f > 6 I_n$: $\pm 10\%$	The best between $\pm 10\%$ and 40 ms
I [50]	$t_t \leq 30$ ms	$\pm 10\%$	--
G [50N TD / 51N]	$t_t = t4$ (with curve $t = k$) $t_t = \frac{2}{\left(\frac{If}{I4}\right)^2}$ (with curve $t = k / I^2$)	$\pm 7\%$	The best between $\pm 10\%$ and 40 ms ⁽²⁾ $\pm 15\%$
MCR	$t_t \leq 30$ ms	$\pm 10\%$	--
2I [50]	⁽¹⁰⁾	$\pm 10\%$	--
IU [46]	$t_t = t6$	$\pm 10\%$	with $t6 \geq 5$ s: ± 100 ms / with $t6 < 5$ s the best between $\pm 10\%$ and ± 40 ms

Startup

Protection [ANSI code]	Trip time t_t	Trip threshold tolerance ⁽³⁾	Trip time tolerance
S StartUp	$t_t = t2$ startup	with $I_f \leq 6 I_n$: $\pm 7\%$ / with $I_f > 6 I_n$: $\pm 10\%$	The best between $\pm 10\%$ and 40 ms
I StartUp	$t_t \leq 30$ ms	$\pm 10\%$	--
G StartUp	$t_t = t4$ startup	$\pm 7\%$	The best between $\pm 10\%$ and 40 ms
S2 StartUp	$t_t = t5$ startup	with $I_f \leq 6 I_n$: $\pm 7\%$ / with $I_f > 6 I_n$: $\pm 10\%$	The best between $\pm 10\%$ and 40 ms

Voltage protections

Protection [ANSI code]	Trip time t_t	Trip threshold tolerance ⁽³⁾	Trip time tolerance
UV [27] / UV2 [27]	$t_t = t8$ (t15)	$\pm 2\%$ ⁽⁴⁾	with $t8 \geq 5$ s: ± 100 ms / with $t8 < 5$ s: the best between $\pm 10\%$ and ± 40 ms
OV [59] / OV2 [59]	$t_t = t9$ (t16)	$\pm 2\%$ ⁽⁴⁾	with $t9 \geq 5$ s: ± 100 ms / with $t9 < 5$ s: the best between $\pm 10\%$ and ± 40 ms
VU [47]	$t_t = t14$	$\pm 5\%$ ⁽¹¹⁾	with $t14 \geq 5$ s: ± 100 ms / with $t14 < 5$ s: the best between $\pm 10\%$ and ± 40 ms

Voltage Advanced protections

Protection [ANSI code]	Trip time t_t	Trip threshold tolerance ⁽³⁾	Trip time tolerance
S(V) [51V] / S2(V) [51V]	$t_t = t20$ (t21)	$\pm 10\%$	with $t20 \geq 5$ s: ± 100 ms / with $t20 < 5$ s: the best between $\pm 10\%$ and ± 40 ms
RV [59N]	$t_t = t22$	$\pm 10\%$	with $t22 \geq 5$ s: ± 100 ms / with $t22 < 5$ s: the best between $\pm 10\%$ and ± 40 ms

Frequency protections

Protection [ANSI code]	Trip time t_t	Trip threshold tolerance ⁽³⁾	Trip time tolerance
UF [81L] / UF2 [87L]	$t_t = t12$ (t17)	$\pm 1\%$ ⁽⁵⁾	with $t12 \leq 5$ s: ± 100 ms / with $t12 < 5$ s: the best between $\pm 10\%$ (min = 30 ms) and ± 40 ms
OF [81H] / OF2 [87H]	$t_t = t13$ (t18)	$\pm 1\%$ ⁽⁵⁾	with $t13 \geq 5$ s: ± 100 ms / with $t13 < 5$ s: the best between $\pm 10\%$ and ± 40 ms

Power protections

Protection [ANSI code]	Trip time t_t	Trip threshold tolerance ⁽³⁾	Trip time tolerance
UP [32LF]	$t_t = t23$	$\pm 10\%$	with $t23 \geq 5$ s: ± 100 ms / with $t23 < 5$ s: the best between $\pm 10\%$ and ± 40 ms
OP [32OF]	$t_t = t26$	$\pm 10\%$	with $t26 \geq 5$ s: ± 100 ms / with $t26 < 5$ s: the best between $\pm 10\%$ and ± 40 ms
RQ [40 o 32R]	$t_t = t24$	$\pm 10\%$	with $t24 \geq 5$ s: ± 100 ms / with $t24 < 5$ s: the best between $\pm 10\%$ and ± 40 ms
OQ [32OF]	$t_t = t27$	$\pm 10\%$	with $t27 \geq 5$ s: ± 100 ms / with $t27 < 5$ s: the best between $\pm 10\%$ and ± 40 ms
D [67]	$t_t = t7$	with $I_f \leq 6$ In: $\pm 7\%$ / with $I_f > 6$ In: $\pm 10\%$	with $t7 \geq 400$ ms: ± 40 ms / with $t7 < 400$ ms: ± 20 ms and $\pm 10\%$, whichever is the highest
RP [32R]	$t_t = t11$	$\pm 10\%$	with $t11 \geq 5$ s: ± 100 ms / with $t11 < 5$ s: the best between $\pm 10\%$ and ± 40 ms

Startup

Protection [ANSI code]	Trip time t_t	Trip threshold tolerance ⁽³⁾	Trip time tolerance
S StartUp	$t_t = t7$ startup	$\pm 10\%$	The best between $\pm 10\%$ and 40 ms
UP StartUp	$t_t = t23$ startup	$\pm 10\%$	with $t23 \geq 5$ s: ± 100 ms / with $t23 < 5$ s: the best between $\pm 10\%$ and ± 40 ms

ROCOF Protection

Protection [ANSI code]	Trip time t_t	Trip threshold tolerance ⁽³⁾	Trip time tolerance
ROCOF [81R]	$t_t = t_{28}$	$\pm 10\%$ ⁽⁶⁾	the best between $\pm 20\%$ and 200 ms

Motor protections

Protection [ANSI code]	Trip time t_t	Trip threshold tolerance ⁽³⁾	Trip time tolerance
R JAM [51LR]	$t_t = t_j$	$\pm 10\%$	with $I_f \leq 6 I_n$: $\pm 7\%$ / with $I_f > 6 I_n$: $\pm 10\%$
R STALL [51LR]	$t_t = t_s$	$\pm 10\%$	$\pm 10\%$
UC [37]	$t_t = t_{uc}$	$\pm 15\%$	$\pm 20\%$
U	$t_t = t_u$ ⁽⁸⁾	$\pm 15\%$	$\pm 20\%$

Note on protections

⁽¹⁾ use trip and threshold current values expressed in I_n for calculating t_t (example: $I_f = 0.8 I_n$, $I_1 = 0.6 I_n$)

⁽²⁾ with $t_4 =$ instantaneous, the maximum tolerance is 50 ms

⁽³⁾ Tolerance values valid with Trip unit at steady state or on with auxiliary power supply, trip time ≥ 100 ms, temperature and signals within operating limits; the tolerances in the table after the notes are applicable if the conditions are not guaranteed

⁽⁴⁾ the trip unit considers 3% hysteresis for quitting alarm condition

⁽⁵⁾ tolerance valid for frequencies within range: $f_n \pm 2\%$. A $\pm 5\%$ tolerance is applicable for off range frequencies

⁽⁶⁾ $\pm 20\%$ for threshold 0.4 Hz / s

⁽⁷⁾ time to be considered valid after Motor start-up

⁽⁸⁾ time to be considered valid with protection in alarm status after Motor start-up; if the alarm appears during Motor start-up, the trip unit calculates and uses the lowest value between t_u and the half of Motor start-up

⁽¹⁰⁾ with $I_f \geq 18$ kA, $t_t \leq 3$ ms;

with $I_f < 18$ kA and $I_f \geq I_{31} * 3$, $t_t \leq 7$ ms (If three-phase) or $t_t \leq 9$ ms (If single-phase);

with $I_f < 18$ kA and $I_f < I_{31} * 3$, $t_t \leq 15$ ms.

(operating parameters guaranteed with Vaux auxiliary power supply)

⁽¹¹⁾ tolerance valid with threshold $U_{14} > 10\%$; with $U_{14} \leq 10\%$ (and $> 6\%$), the tolerance is 10%; with $U_{14} < 5\%$, the tolerance is 15%

Performance guaranteed in all operating conditions

Protection	Trip threshold tolerance	Trip time tolerance
L	Activation within range: $(1.05 \text{ to } 1.2) \times I_1$	$\pm 20\%$
S	$\pm 10\%$	$\pm 20\%$
I / 2I	$\pm 15\%$	≤ 60 ms
G	$\pm 15\%$	$\pm 20\%$ (60 ms with $t_4 =$ instantaneous)
UF / UF2 / OF / OF2	$\pm 2\%$	$\pm 20\%$
RV	$\pm 10\%$	$\pm 20\%$; in the case of single-phase self-supply: the highest between $\pm 20\%$ and 30 ms
Other	--	$\pm 20\%$

13 - Functions

Introduction This chapter includes the trip curves of the protections, which are shown in different point charts:

- The curves are represented considering the maximum and minimum values of the parameters of each protection, including the TRIP functions provided (current, time).
- Protections with several curves (example: S protection), are shown in several graphs.
- The curves do not take account of the effects of special parameters, such as thermal memory and startups.



NOTE: it is advisable to always use the mathematical function in the summary table of the protections to calculate the trip time (page **81**)

Function L ($t = k/I^2$)

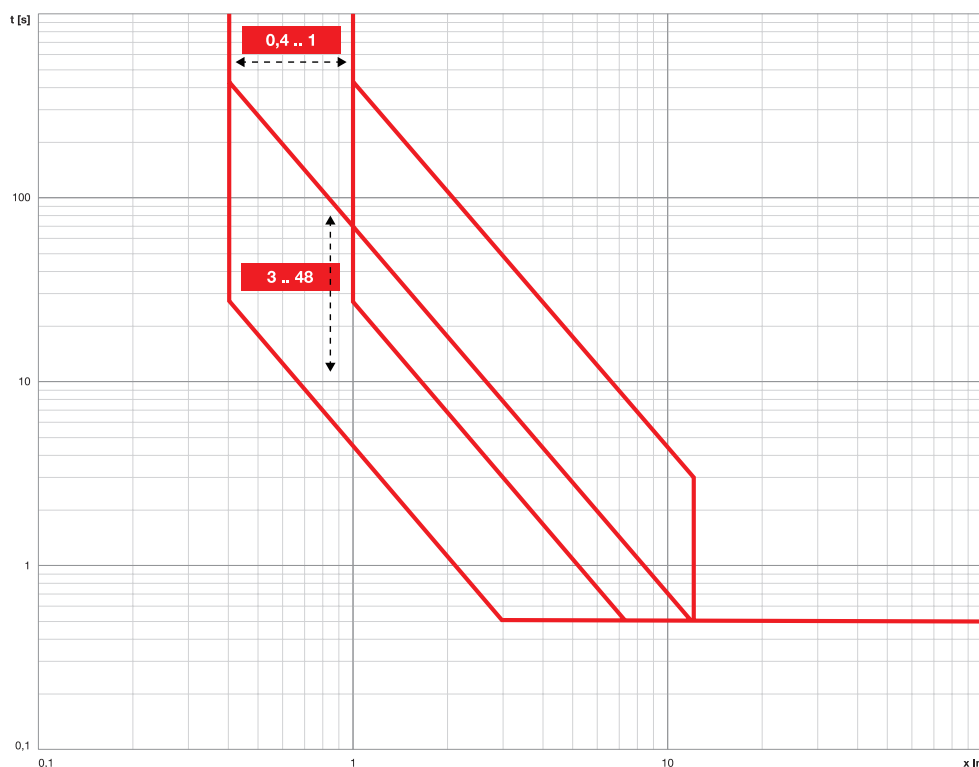

Function L (IEC 60255-151 SI)

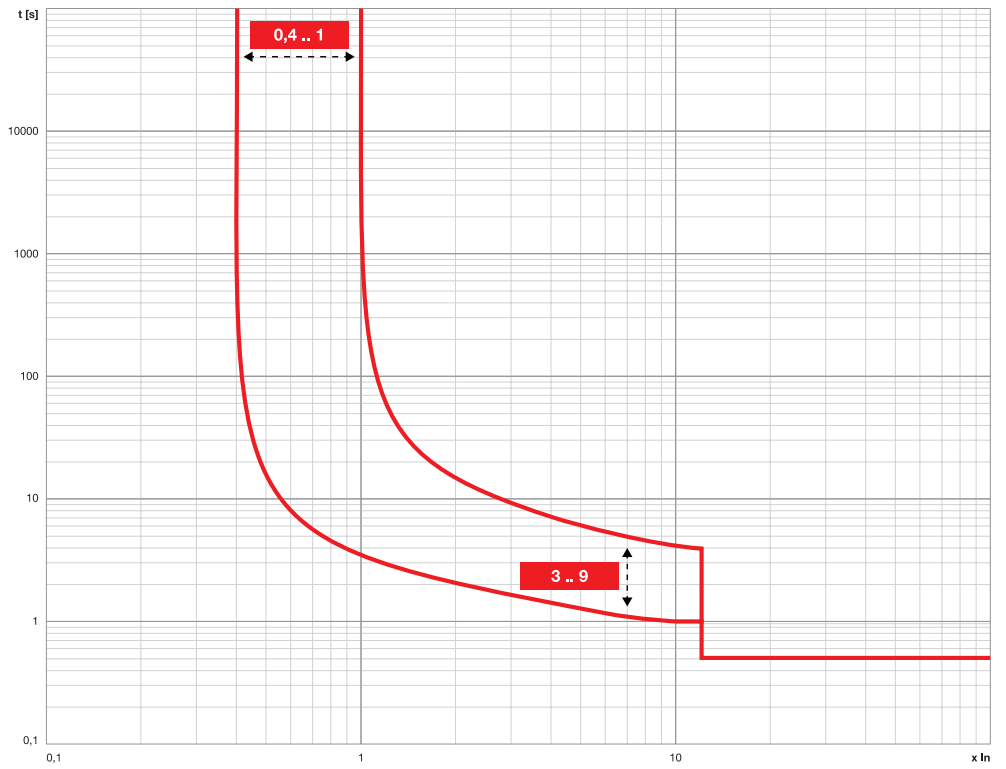

Function L (IEC 60255-151 VI)

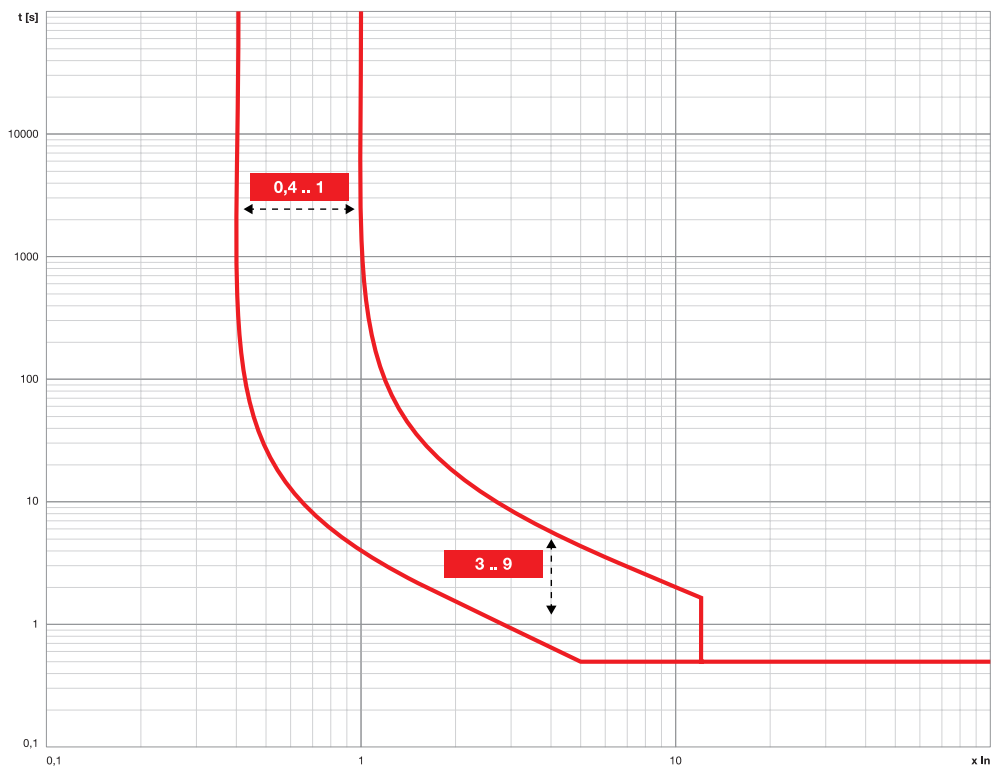

Function L (IEC 60255-151 EI)

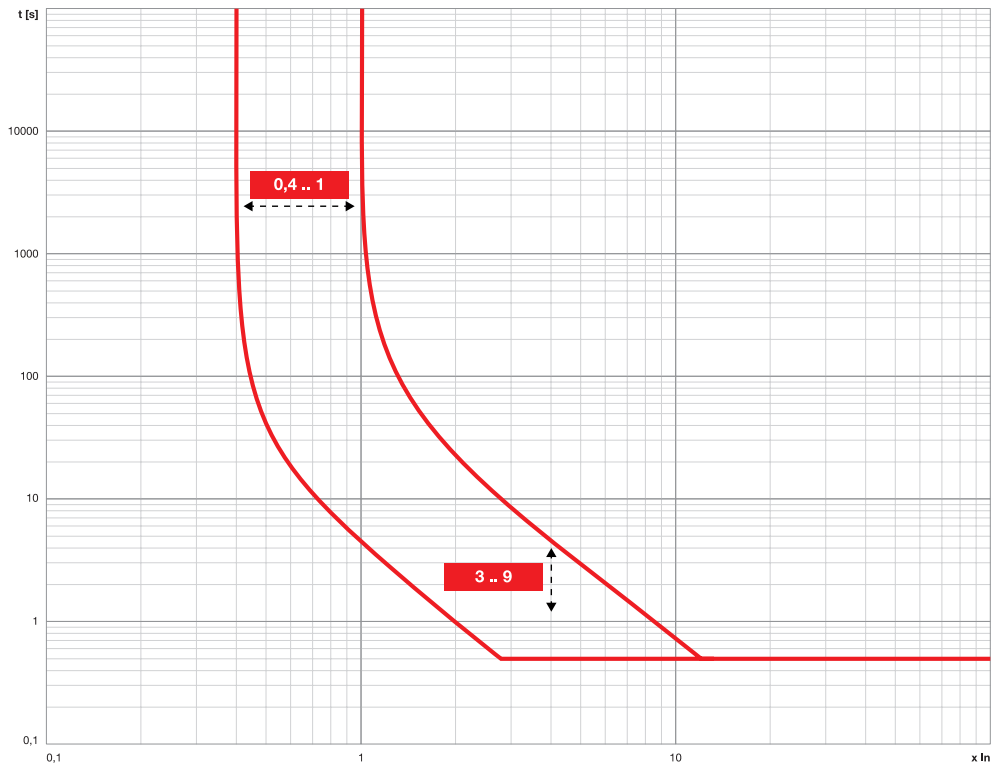

Function L ($t = k/I^4$)

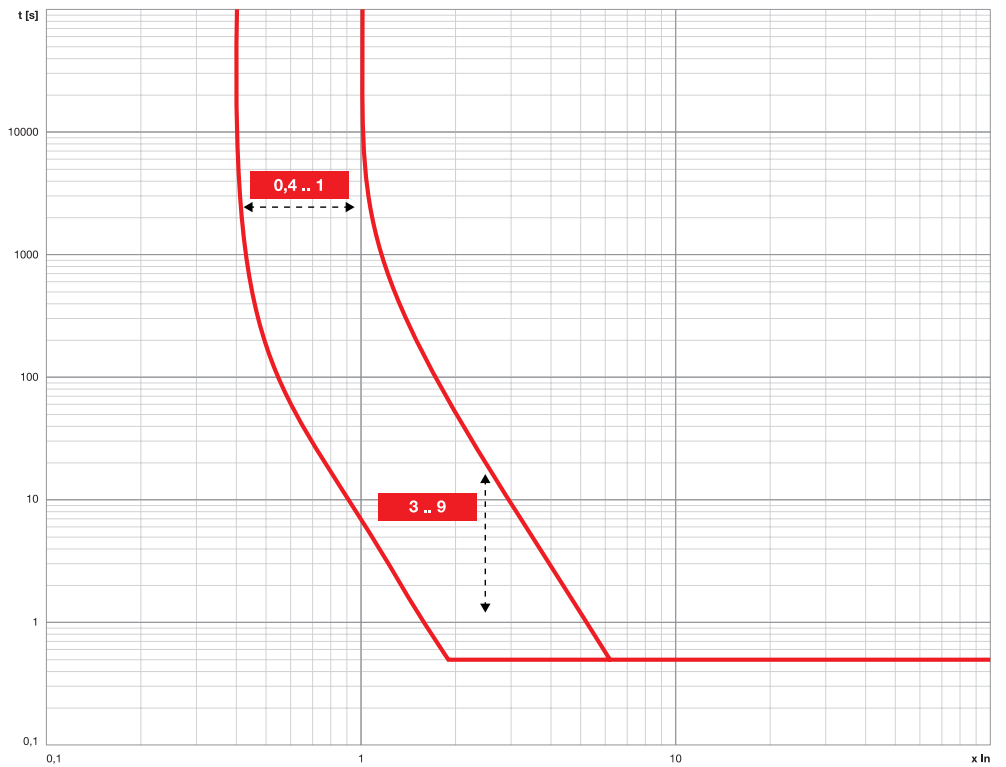

Function L (Ekip M Touch)

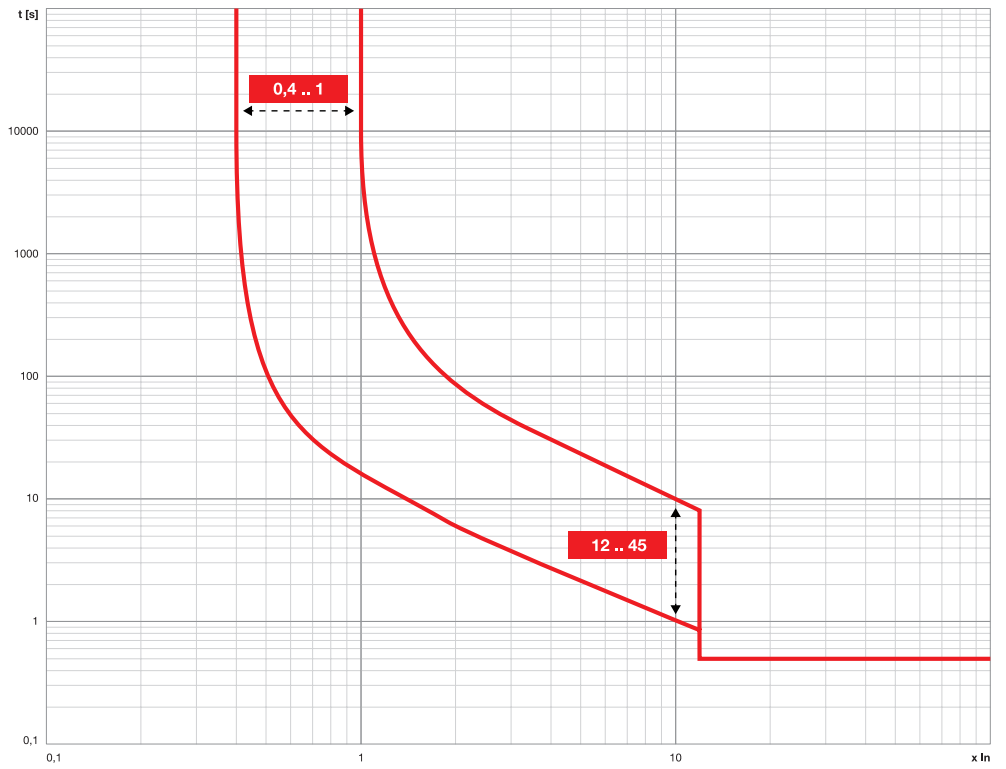

Function S ($t = k/I^2$)

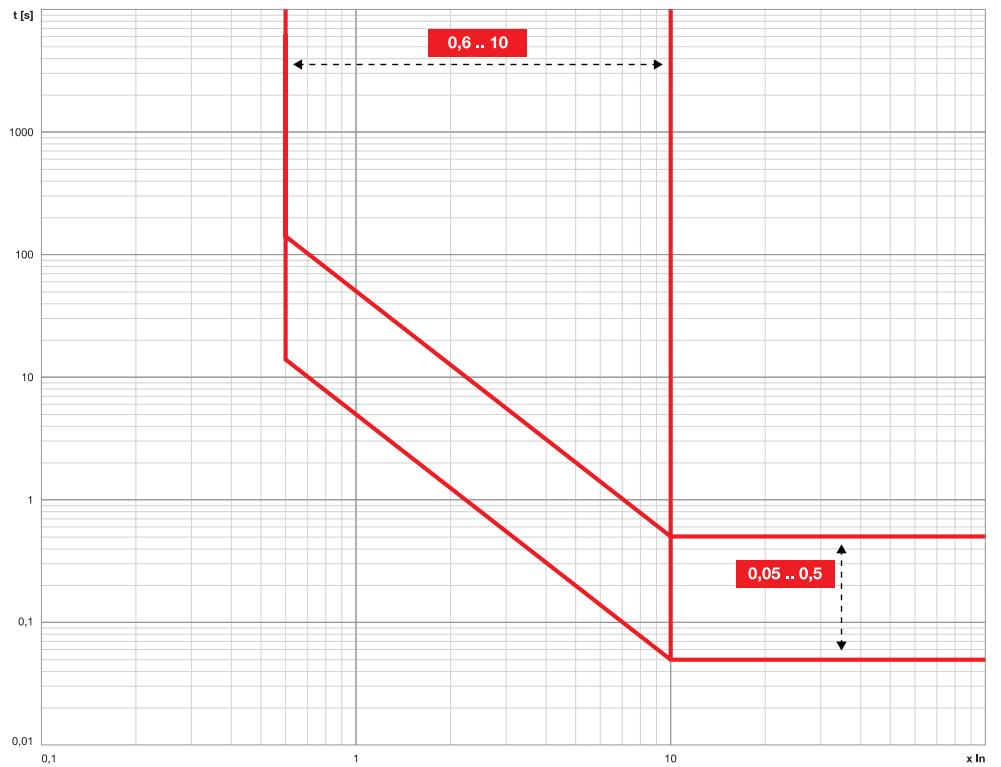

Function S (t = k) \ Function S2

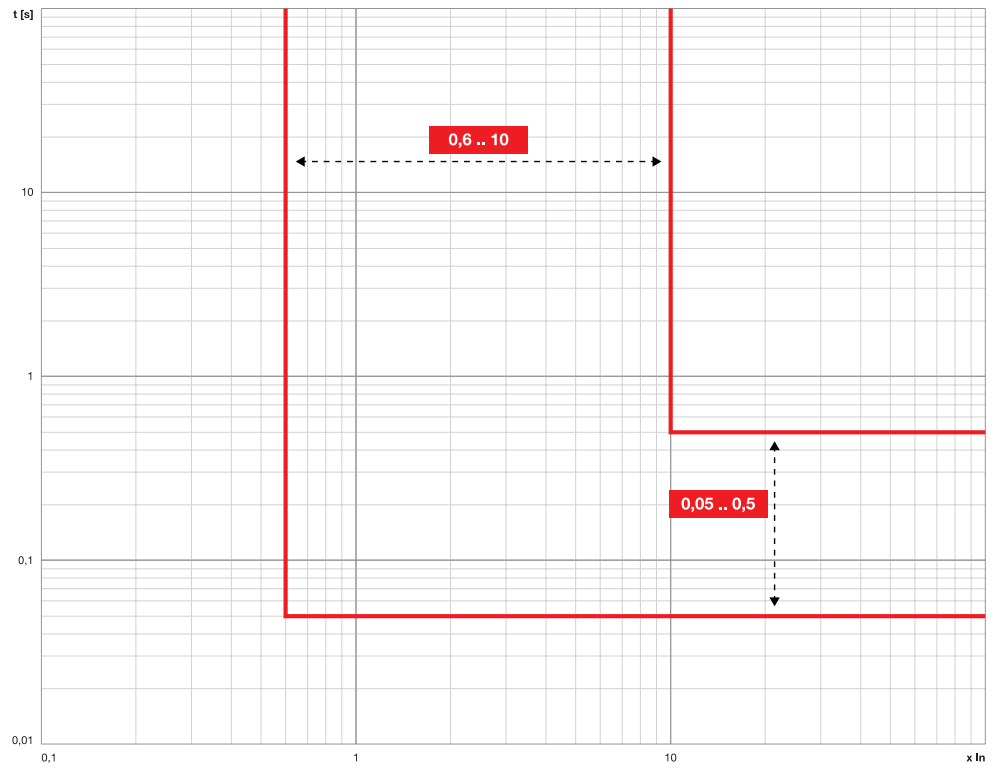

Function I \ Function MCR

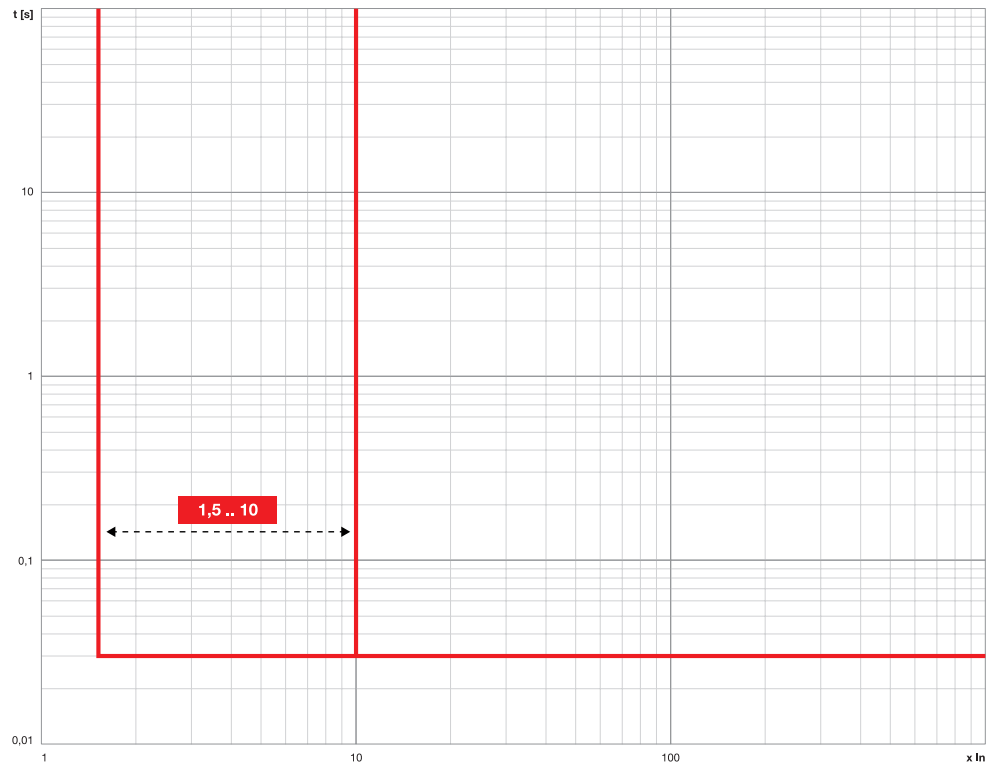

Function 2I

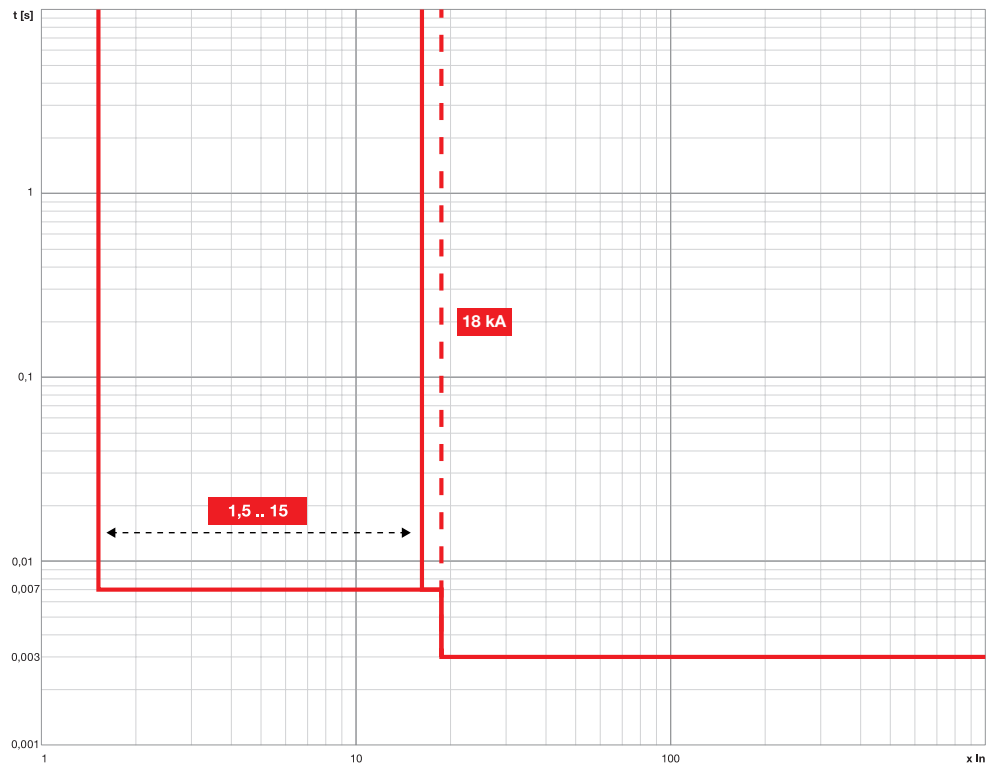

Function G ($t = k/I^2$)

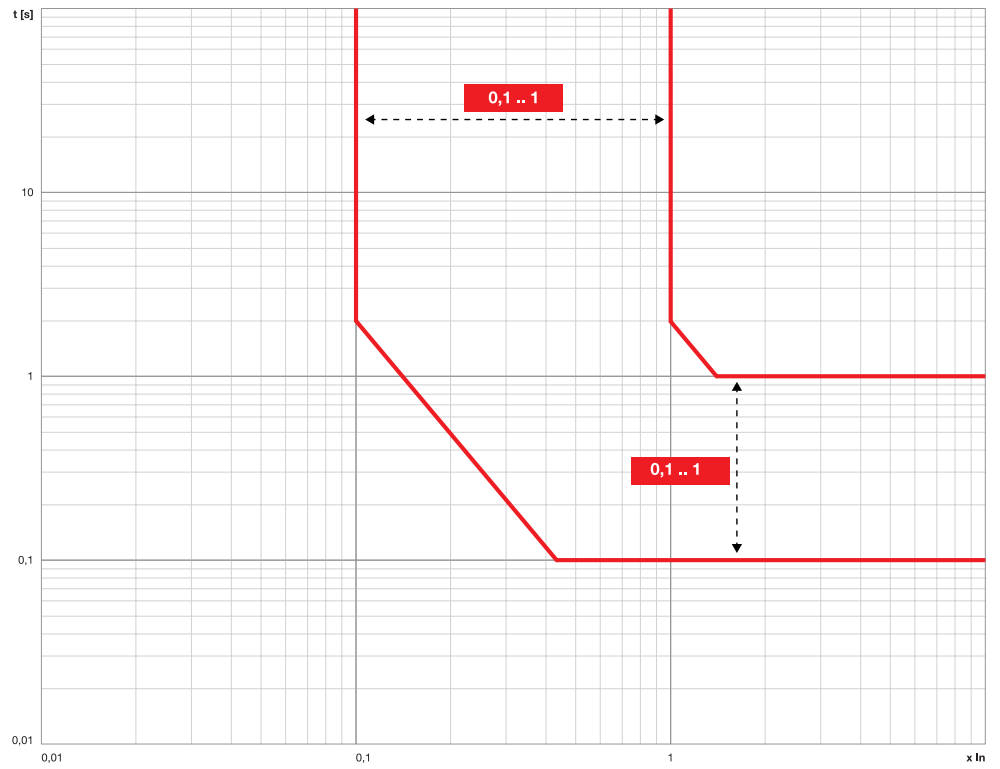

Function G ($t = k$)

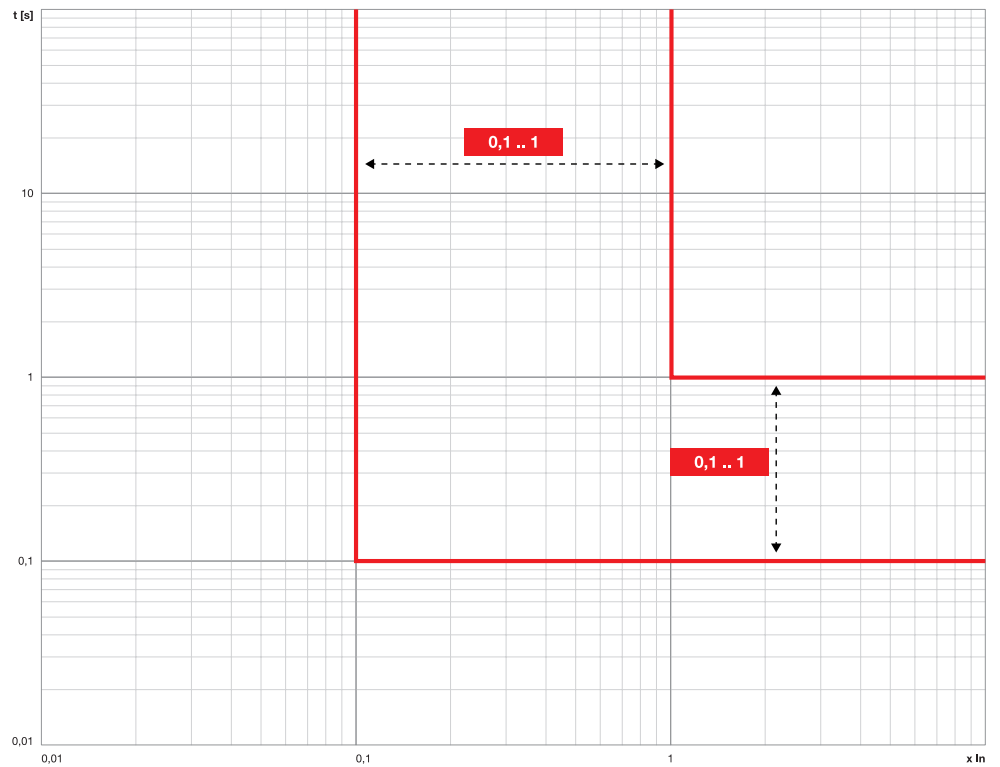

Function IU

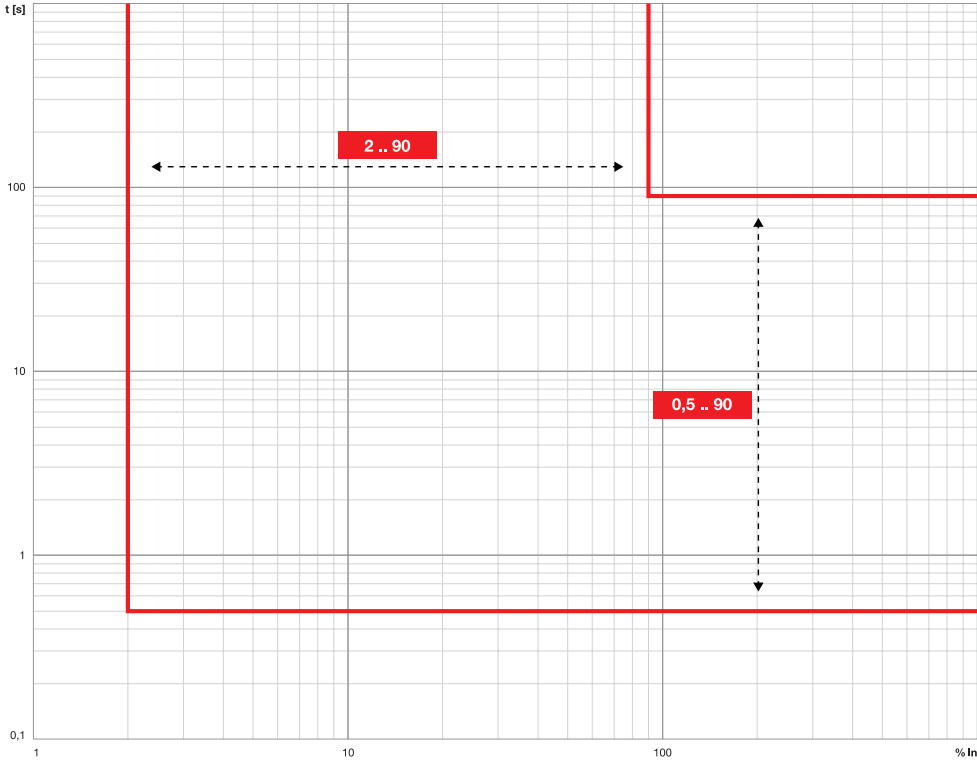

Function UV \ Function UV2

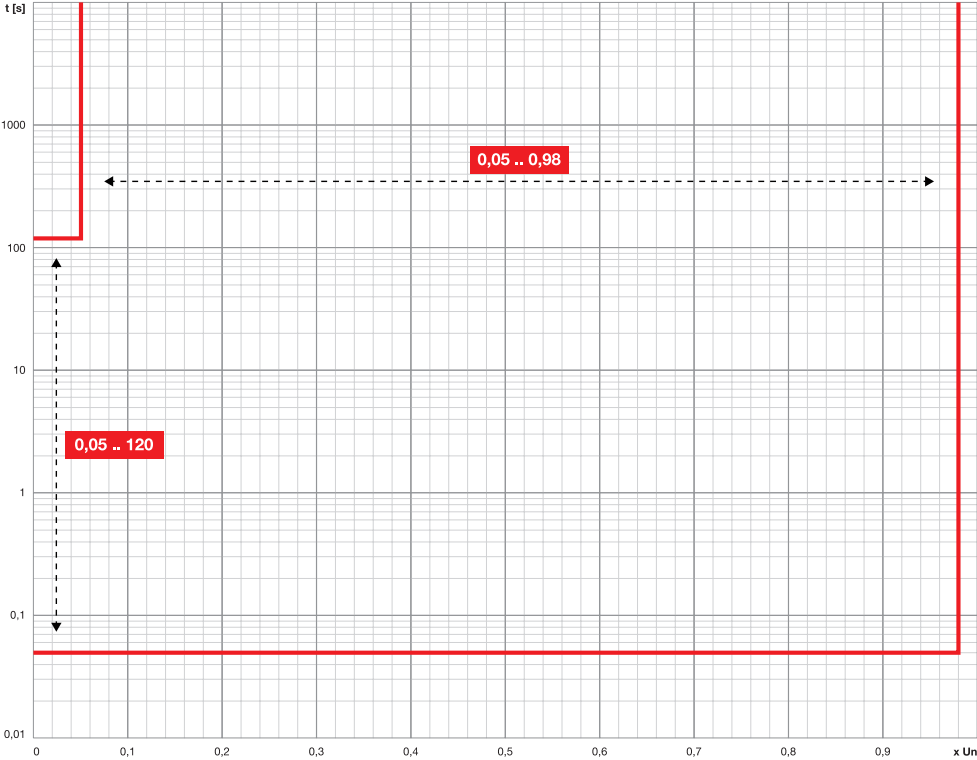

Function OV \ Function OV2

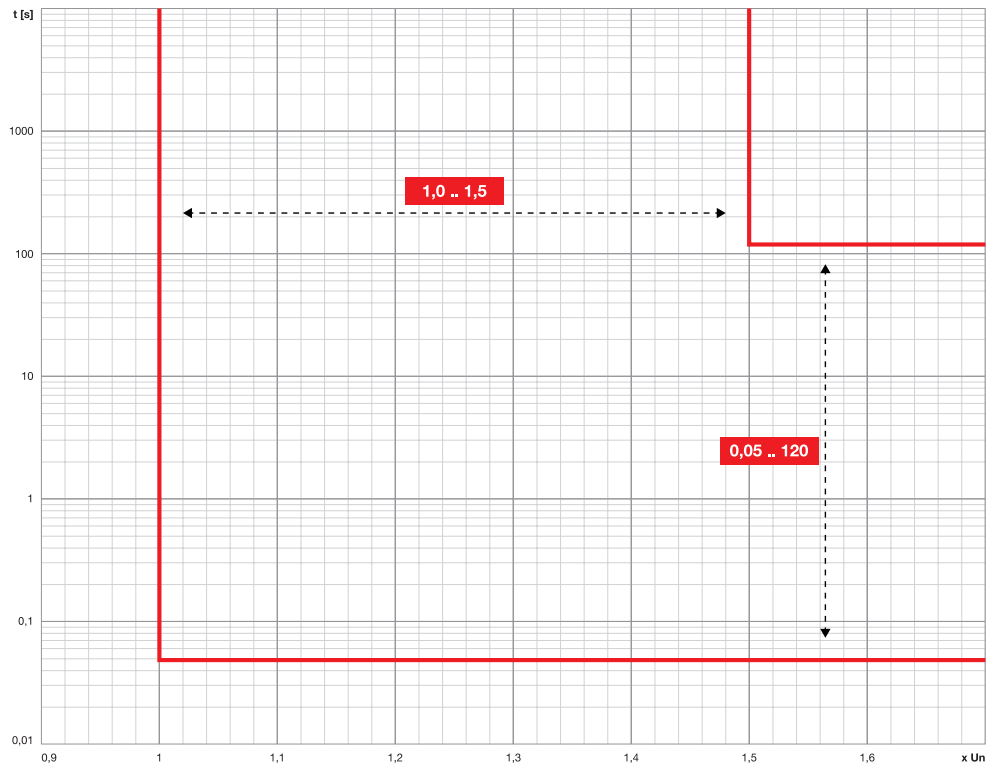

Function VU

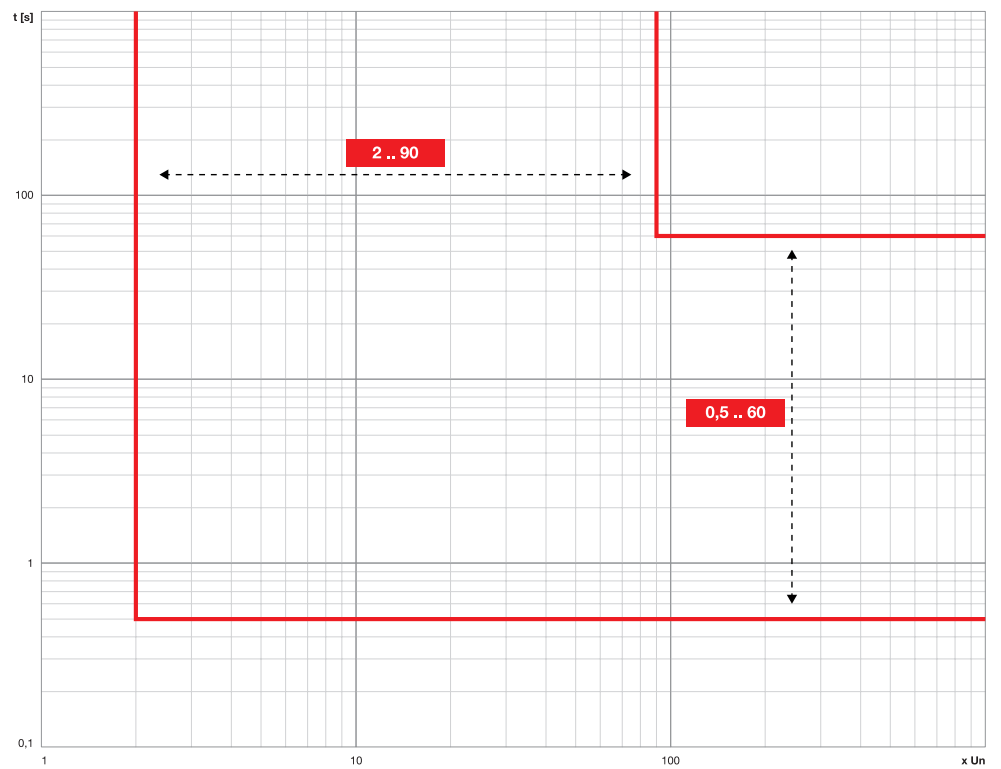

Function S(V) \ Function S2(V)

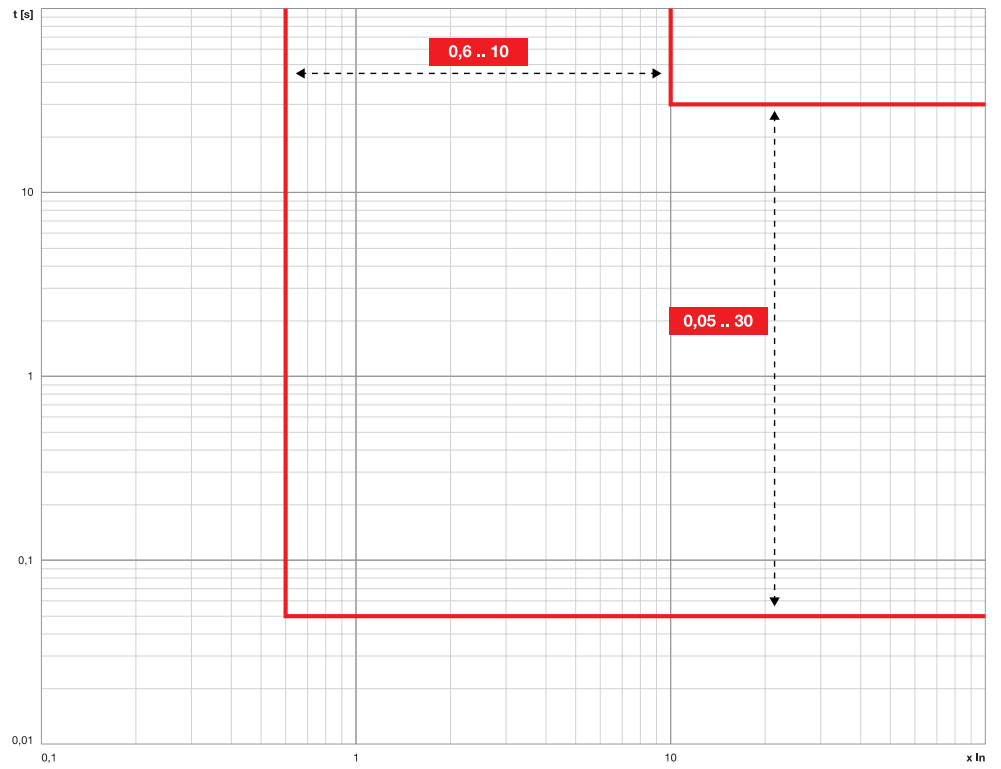

Function RV

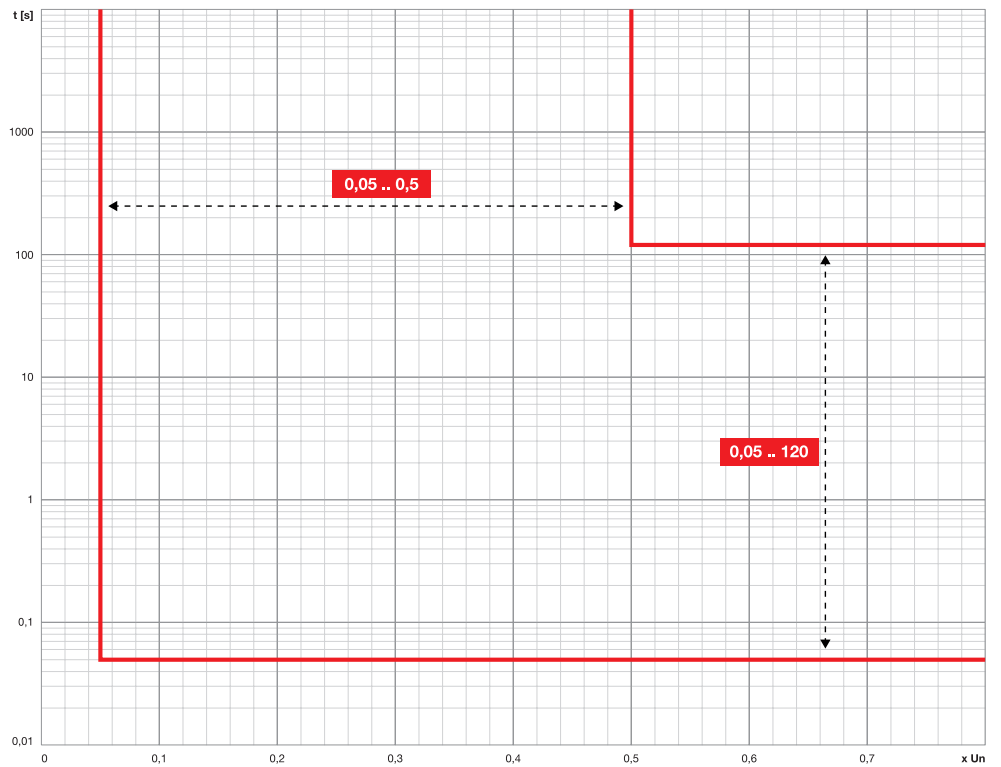

Function UF \ Function UF2

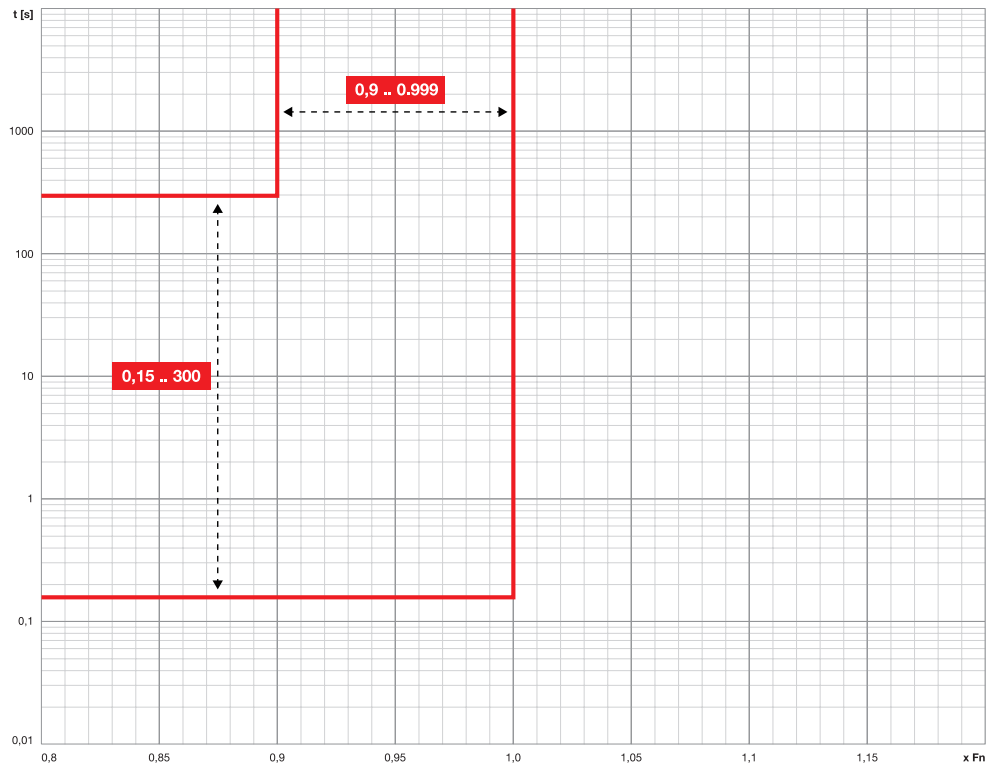

Function OF \ Function OF2

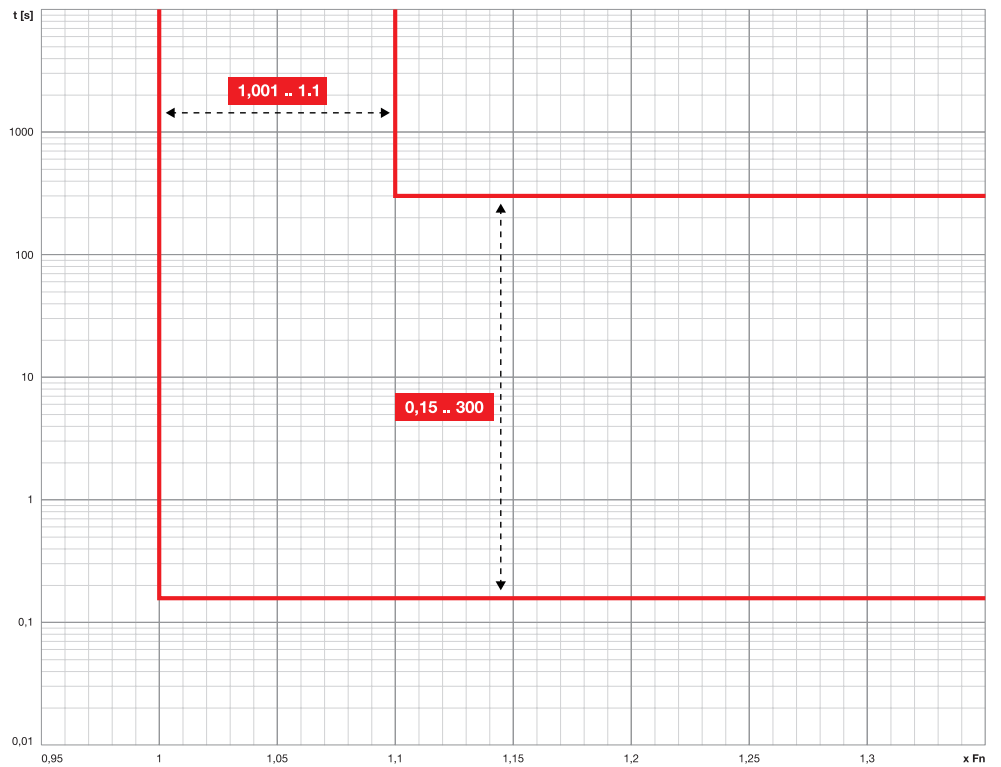

Function RP

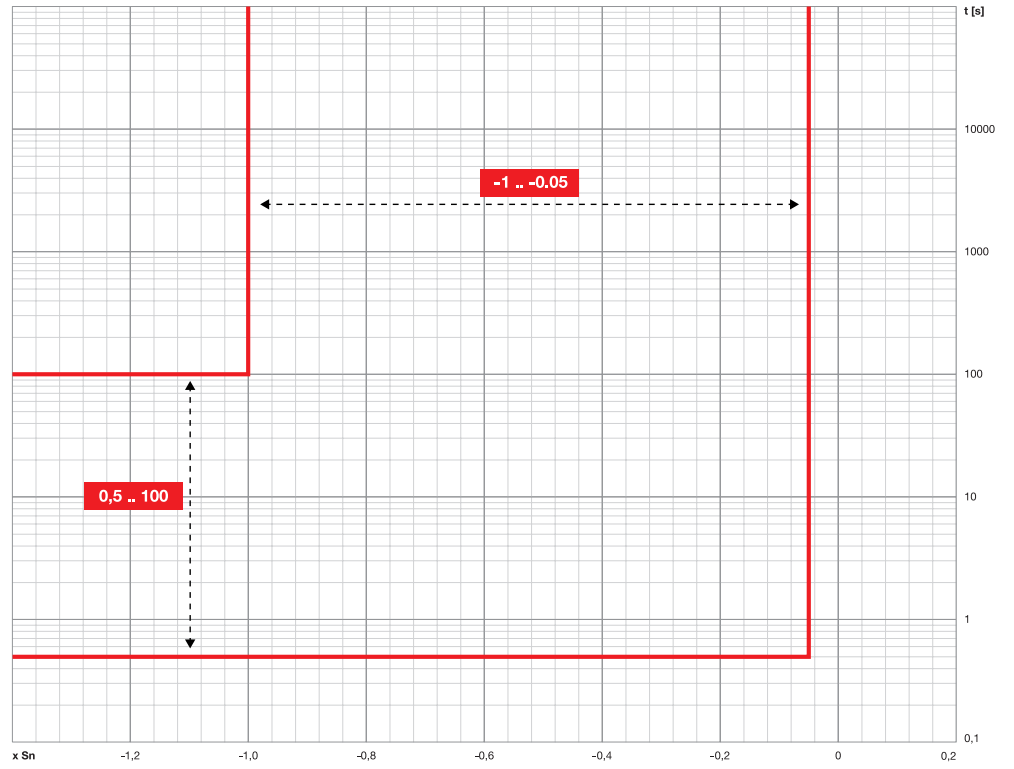

Function D

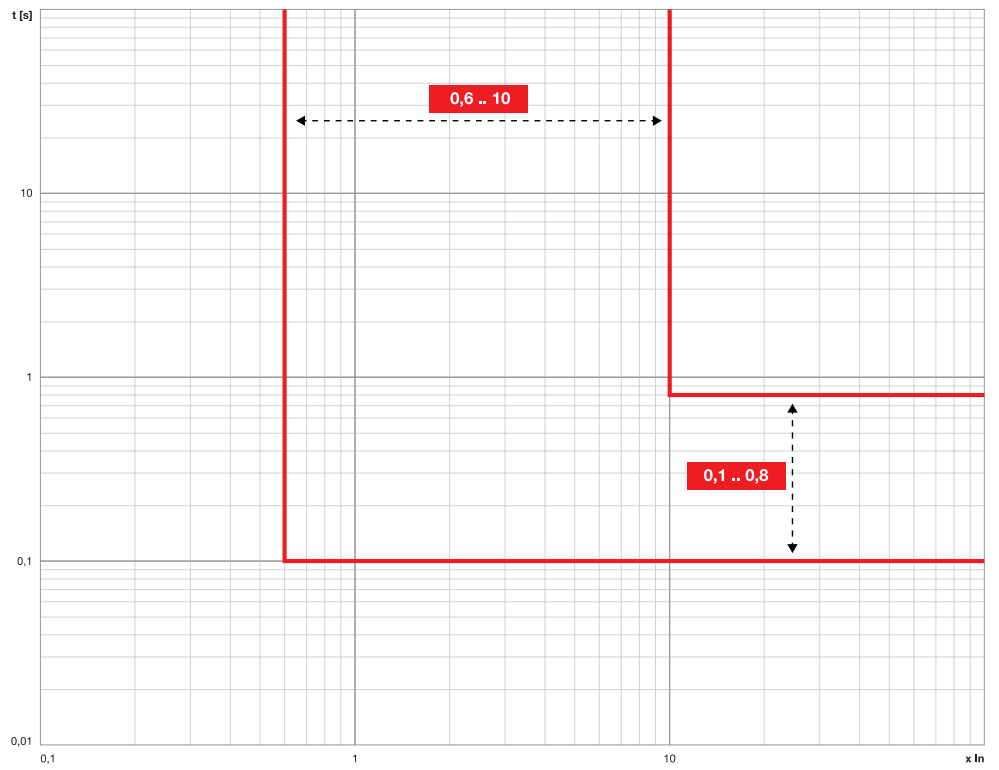

Function OQ

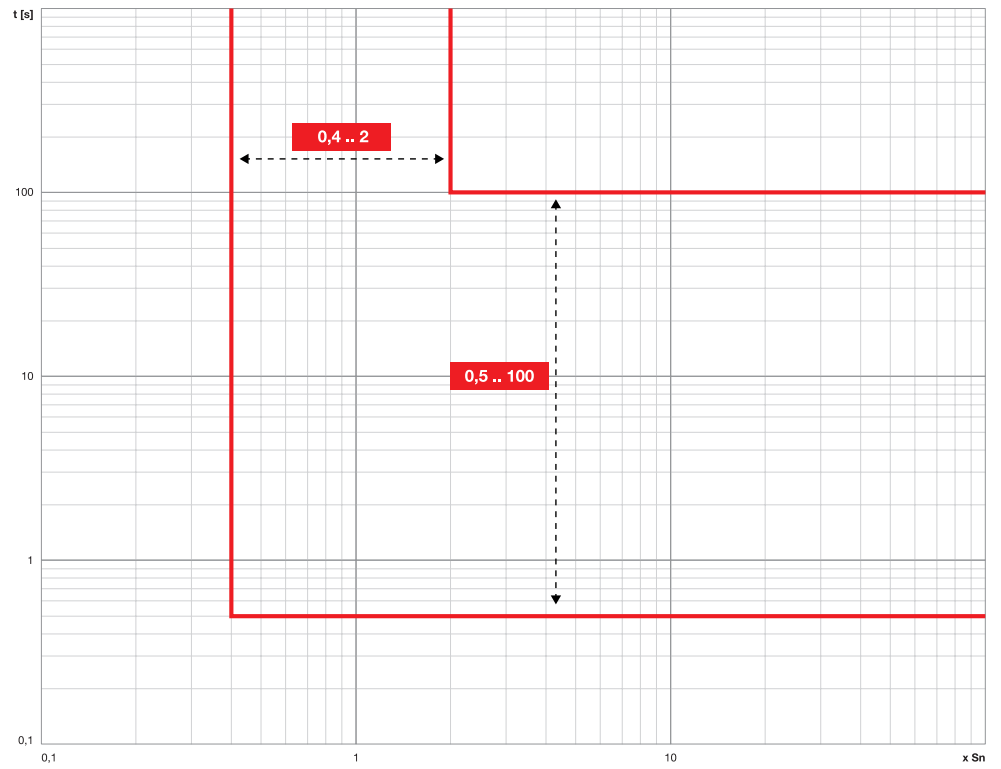

Function OP

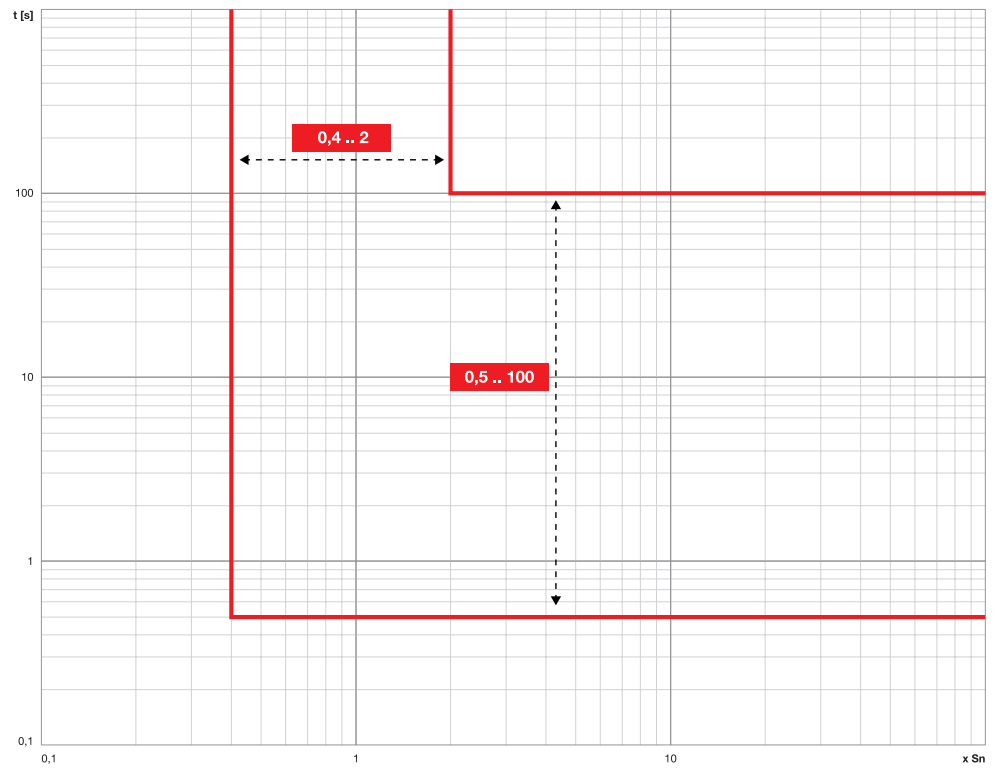

Function UP

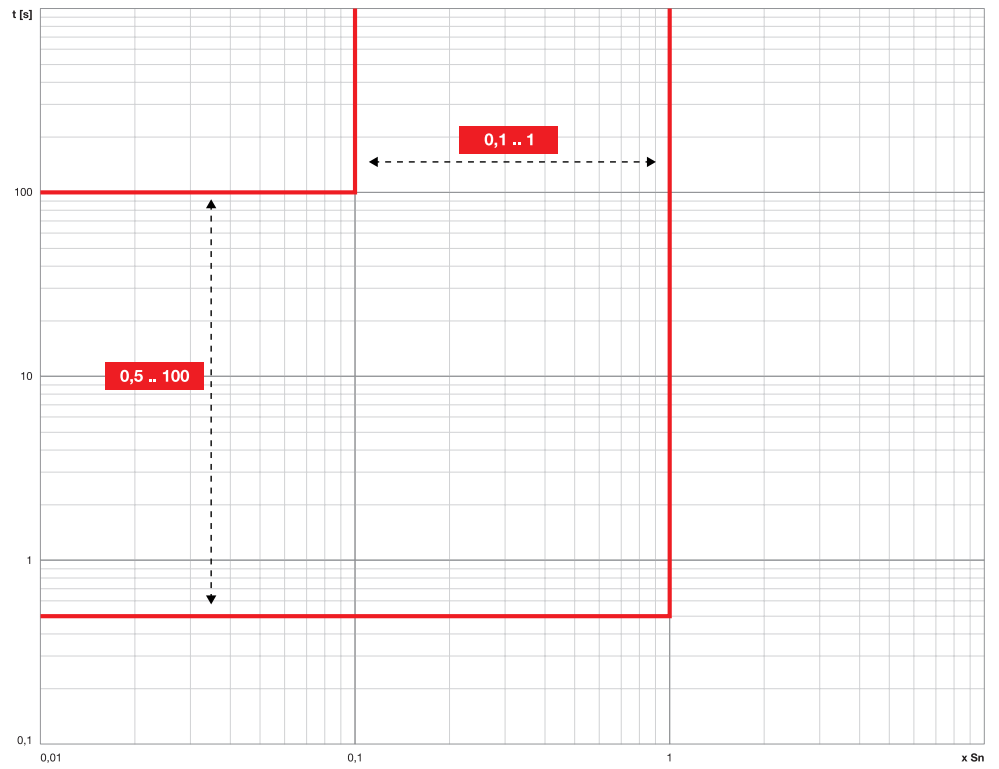

Function RQ

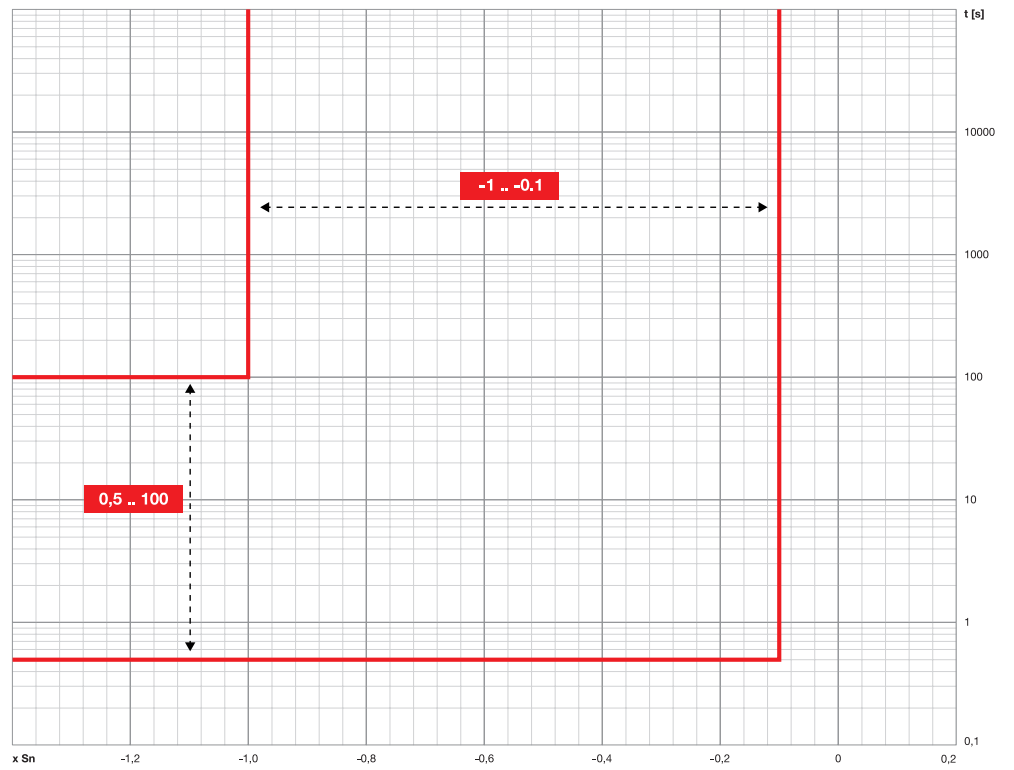

Function ROCOF

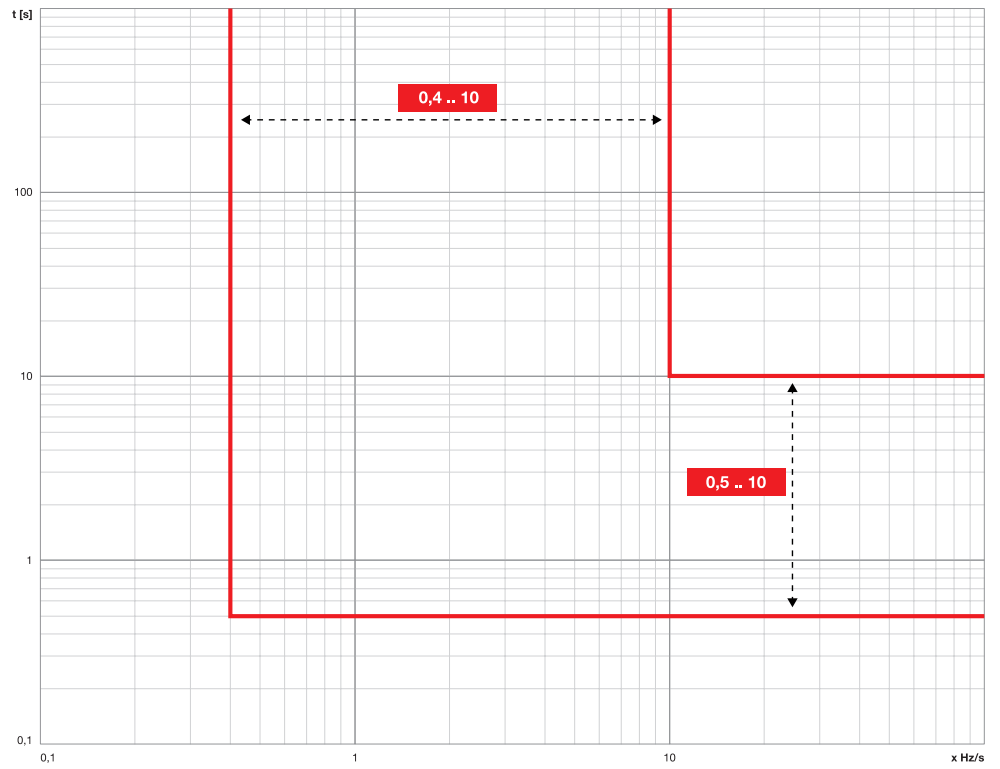

Function R JAM

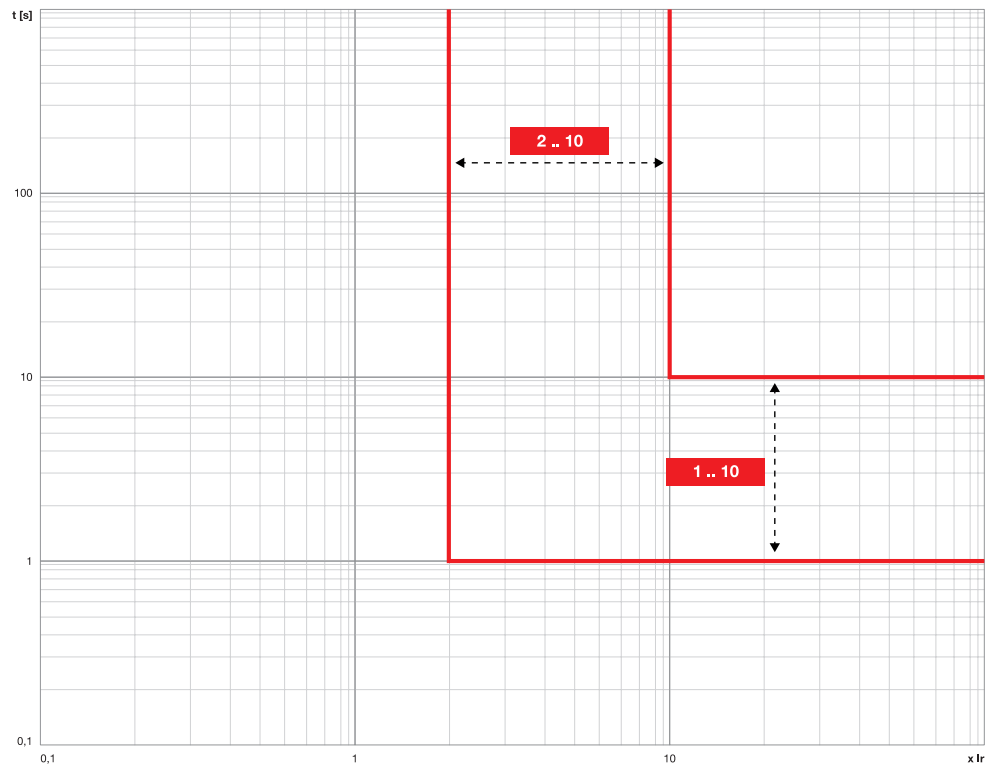

Function R STALL

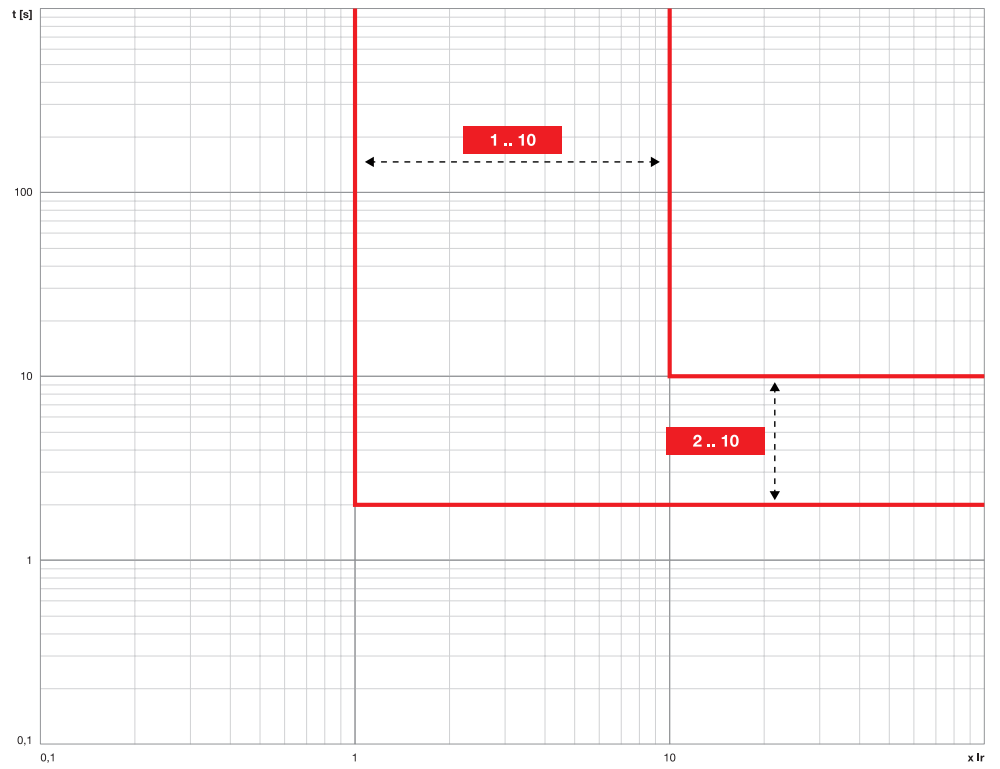

Function UC

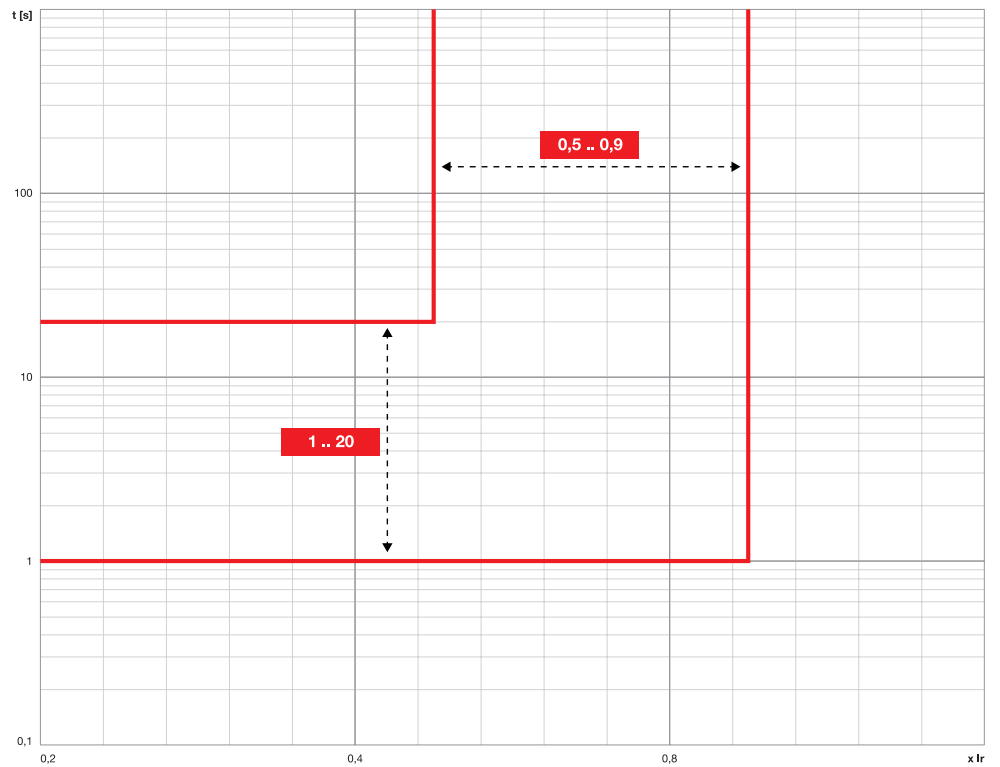

Ekip Touch - Measurements

1 - Standard Measurements

List The Standard measurements are:

Parameter	Description	Page
<i>Instantaneous currents</i>	Phase current and earth fault measurements in real time	100
<i>Events</i>	List of events, status changes, alarms, recorded by the Trip unit	100
<i>Trip</i>	List of current protection trips (TRIP)	100
<i>Min-Max measurements</i>	History of minimum and maximum currents, recorded at a settable interval	102
<i>Maintenance</i>	CB status: contact wear and last maintenance	103
<i>Operation counters</i>	Number of mechanical and electrical operations	103

Instantaneous currents The instantaneous currents, available in the *Measurements* pages, are real time measurements of the phase and earth fault currents expressed in root mean square value; the monitor time and performance depend on the rated current defined by the Rating plug (In):

Measurement	Monitor time (min-max)	Normal operating range	Accuracy of value read ⁽¹⁾
<i>Phase currents</i> ⁽⁴⁾	0,004 ÷ 64 In	0,2 ÷ 1,2 In	1% ⁽³⁾
<i>Internal earth fault current</i> ⁽²⁾	0,08 ÷ 64 In	0,2 ÷ 1,2 In	2 % ⁽³⁾

⁽¹⁾ the accuracies refer to normal operating ranges, as established by IEC 61557-12

⁽²⁾ available with LSIG versions

⁽³⁾ accuracies based on Ekip Touch and Ekip Touch Measuring without Class 1 Power & Energy Metering package; if the Class 1 Power & Energy Metering package is present and for all other trip unit models, check the indicated performance values from page 107

⁽⁴⁾ the higher phase currents are also available in the Histograms, Measuring instruments and Measurement summary pages

Special representations

Type of measurement	Measurement < min value	Measurement < max value	"_ _ _" displayed: (not available) due to
Internal earth fault and phase currents	[64 In] ⁽¹⁾	Sensors disconnected

⁽¹⁾ gives the value nearest to the theoretic maximum threshold considering the measurement resolution; example: if In=1000 A the value given is 63999 A

Events Ekip Touch can record the last 200 events, mainly concerning variations in the status and operation of the unit; in particular:

- configuration status of the bus, operating mode, active set, auxiliary supply
- connection statuses or alarms: current sensors, *Trip Coil*
- connection statuses or alarms: current sensors, *Rating Plug, Trip unit, Trip Coil*
- protections: timing in progress or alarm
- trip: status of open command, signaling of trips due to protection



NOTE: *the first event available in the list is the most recent one; having reached the 200-events threshold, the oldest events will be progressively overwritten*

The complete list is available in the *Measurements - Historicals - Events* menu, where a set of information is given for each event: icon of the type of event, name of event, date and time recorded.

There are 4 icons that identify the type of event:

Icon	Description
	Event reported for information purposes
	Timing of a protection in progress, trip expected
	Alarm referring to a non-dangerous condition
	Alarm concerning operation, a fault or connection failure

Tripping Ekip Touch is able to record the last 30 TRIPs.

The complete list is available in the *Measurements - Historicals - Trips* menu, where useful information is given for each trip:

- the protection that caused the trip
- the consecutive number of the trip
- the date and time of the trip (with reference to the internal clock)
- the measurements associated with the tripped protection



NOTE: *once the 30-TRIP threshold has been exceeded, the oldest trips are progressively overwritten*

Correlated measurements

The type of protection involved determines the measurements recorded at the moment of tripping:

Protection	Measurements recorded	Notes
Current	L1, L2, L3, Ne, Ig Currents	Ne is available with CBs type 4P and 3P + N; Ig is available in the case of trips due to G protection
Temperature	L1, L2, L3, Ne Currents	The temperature cannot be displayed

Access to most recent trips

Besides being available in the *Historicals* menu, information about the most recent trips can be accessed in three different ways, depending on the conditions of Ekip Touch:

Condition	Access
Trips that have just occurred with Ekip Touch on	The main page is temporarily replaced by a trip information page; press the iTEST button to reset and go back to the normal screen page
Trips that have just occurred with Ekip Touch off	Press the iTEST button to display the trip information page for a few seconds
Rapid consultation in all the other conditions	Press the iTEST button four times from any page other than a menu, or a page accessed via a menu

Min-Max measurements Ekip Touch records the maximum and minimum phase currents in the *Measurements - Historicals - Measurements* menu

The recording interval between one measurement and the next can be set via the Monitor time parameter, available in the *Settings* menu (page 35).

Representation

Select one of the measurements to access the graph page containing the records

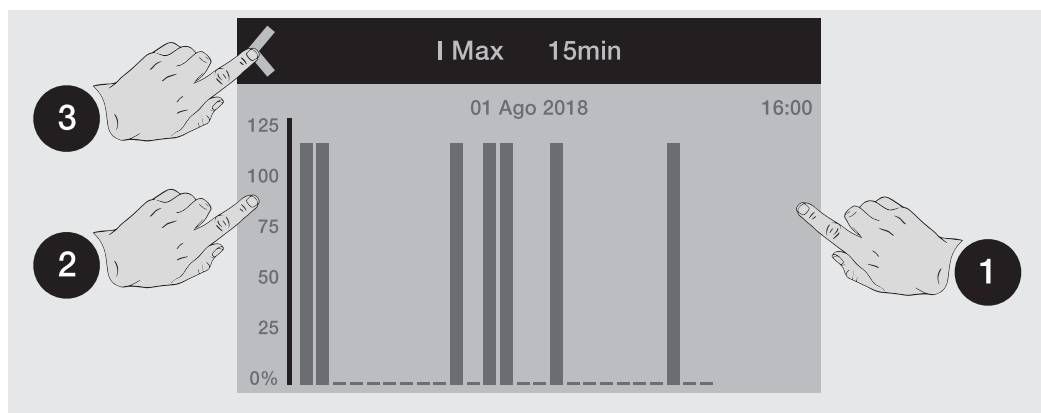

Each measurement allows up to 25 recordings, each shown in a bar chart (graphic full scale equal to 125% of the rated value).

The selected recording flashes, to distinguish it from the others.

Touch the sides of the display to select the recordings after **(1)** and before **(2)** the selected recording. The command for quitting the page **(3)** is in the top left corner.

Use the **Enter**, **ESC**, **Right/Up** and **Left/Down** to scroll all the recorded measurements.

The selected recording flashes, to distinguish it from the others.

- phase and value of measurement
- date and time of recording



NOTES:

- if the value is less than the minimum viewable threshold, “...” is indicated instead of the value
- graphic representation is in relation to 1 In, with 1.25 In as maximum value
- the trip unit immediately makes a recording when the “Monitor time” parameter is changed

Reset measurements

The Reset measurements command is available in the *Measurements - Historicals - Measurements* menu, for the purpose of resetting all the recordings

Maintenance Certain information about the status of the CB is available in the *Measurements-Maintenance* menu.

Contact Wear

Contact wear provides an estimation of the state of wear of the main contacts of the circuit-breaker. The value is given in percentage form and is 0% if there is no wear and 100% if the contacts are completely worn

It is calculated automatically by the Trip unit whenever a trip is caused by a protection or, in the presence of auxiliary power supply, whenever the circuit-breaker is opened in the manual mode.



NOTES:

- the percentage is no longer increased once 100% has been reached
- 80% wear is signaled by a prealarm, while 100% is signaled by an alarm



IMPORTANT: 100% wear does not impose any functional limit on the Trip unit; however, the state of the circuit-breaker must be checked as soon as possible

Maintenance

The *Maintenance* function allows the user to be alerted by a Warning that:

one year has elapsed since maintenance was last performed

contact wear has increased by over 10% with respect to the last maintenance value

Two areas are available in the Trip unit menu:

- Activation area (*Settings - Maintenance* menu): allows the *Maintenance* function to be activated
- Measurement and reset area (*Measurements - Maintenance* menu): only appears if the *Maintenance* function is activated; provides information about maintenance (contact wear and dates) and the command for confirming that maintenance has been performed (confirming records the actual date and contact wear values, and resets the alarm signal).

The reference date is that of the internal clock and the time elapsed is calculated with the trip unit both on and off (so long as the internal battery functions).



NOTE: manual modification of the date may cause variations to the elapsed time calculation, thus to the next maintenance date



NOTE: the maintenance signal due to increased contact wear is given for values exceeding 20%

Operation counters The CB operations (total manual operations and TRIPs) are recorded by the Trip unit in the presence of auxiliary power supply and are available in the *About-Circuit breaker* menu.

The following counters are also available when communication with the Trip unit is activated:

- number of mechanical operations
 - number of trips due to protection trips (TRIP)
 - number of trips due to failed protection trips (TRIP)
 - number of trip tests performed
-

2 - Measuring Measurements

List The Measuring measurements are

Condition	Access	Page
<i>Instantaneous voltages</i>	Phase and line-to-line voltage measurements in real time	104
<i>Instantaneous powers</i>	Real time measurements of the active, reactive, apparent phase and total powers	104
<i>Instantaneous frequency</i>	Measurement of the line frequency	104
<i>Trip</i>	List of trips (TRIP) due to voltage, frequency, power protections	105
<i>Min-Max-Med measurements</i>	History of minimum, maximum and mean voltages and powers recorded within a settable range	105
<i>Peak factor</i>	Real time measurement of the peak factor of the currents	105
<i>Power factor</i>	Real time measurement of the power factor	105
<i>Energy counters</i>	Measurement of active, reactive, apparent energy	105

The relative associated measurements are activated by means of the *Ekip Synchrocheck* module (page 167).

Instantaneous measurements

Instantaneous currents, available in the *Summary pages*, are real time measurements of the line-to-line and phase voltages expressed in root-mean-square value.

Representation, measuring range and performance depend on the set rated voltage (U_n).

Available in the *Summary pages*, the instantaneous powers are real time measurements of the phase and total active powers.

Representation, measuring range and performance depend on the set rated voltage (U_n) and on the rated current defined by the rated size of the Trip unit (I_n); in addition, the reference changes on the basis of the type of measurement:

- S_n for total powers ($S_n = I_n \cdot U_n \cdot \sqrt{3}$).
- P_n for phase powers ($P_n = I_n \cdot U_n / \sqrt{3}$).



NOTE: the phase powers and voltages are available with 4P and 3P + N CBs

Measurement	Monitor time (min-max)	Normal operating range	Accuracy of value read ⁽¹⁾
Line-to-line voltages ⁽⁶⁾	5 V ÷ 900 V	100 ÷ 690 V	0.5 %
Phase voltages	5 V ÷ 900 V	50 ÷ 400 V	0.5 %
Line frequency	30 ÷ 80 Hz ⁽²⁾	f -10 % ÷ f +10 % ⁽⁴⁾	0,1 % ⁽³⁾
Total active, reactive and apparent power ⁽⁷⁾	Pmin ÷ Pmax ⁽⁵⁾	0,3 ÷ 1,2 S_n	2 % ⁽³⁾
Active, reactive and apparent phase power	Pmin ÷ Pmax ⁽⁵⁾	0,3 ÷ 1,2 P_n	2 % ⁽³⁾

⁽¹⁾ the accuracies refer to normal operating ranges, as established by IEC 61557-12

⁽²⁾ available for voltage values of over 30 V (with $U_n < 277$ V) or 60 V (with $U_n > 277$ V)

⁽³⁾ accuracies based on *Ekip Touch* and *Ekip Touch Measuring without Class 1 Power & Energy Metering* package; if the *Class 1 Power & Energy Metering* package is present and for all other trip unit models, check the indicated performance values from page 107

⁽⁴⁾ 45 to 55 Hz with set frequency = 50 Hz; 54 to 66 Hz with f = 60 Hz

⁽⁵⁾ $P_{min} = 0,5 I_n \times 5$ V; $P_{max} = 3 \times 16 I_n \times 900$ V

⁽⁶⁾ the higher line-to-line voltages are also available in the *Histograms*, *Measuring instruments* and *Measurement summary pages*

⁽⁷⁾ the higher total powers are also available in the *Measuring instruments* and *Measurement summary pages*

Continued on the next page

Special representations

Type of measurement	Measurement < min value	Measurement < max value	“_ _ _” displayed: (not available) due to
Line-to-line and phase voltages	899,97 V	Measurement module not detected
Line frequency	30 Hz	80 Hz	Measurement module not present, $V < 5\text{ V}$
Active, reactive and apparent total and phase power	$> [P_n \times 1,25]$	Sensors disconnected, Measurement module not present, $V < 5\text{ V}$, $I < 0.03\text{ In}$
Voltage U0		$> [U_n \times 1,25]$	

Tripping The *Measuring Measurements* page adds to the range of TRIPs that Ekip Touch is able to record (page 105).

The voltage, frequency or power protection that trips determines the measurements recorded the moment the trip occurs

Protection	Measurements recorded	Notes
Voltage	Currents L1, L2, L3, Ne, voltages U12, U23, U31, U0	Ne is available with CBs type 4P and 3P + N; U0 is available in the case of trips due to RV protection
Frequency	Currents L1, L2, L3, Ne and grid frequency	Ne is available with CBs type 4P and 3P + N
Power	Currents L1, L2, L3, Ne and total power	Ne is available with CBs type 4P and 3P + N; Active or apparent total power depending on which protection tripped

Min-Max-Med measurements

The *Measuring Measurements* package adds to the range of measurements that Ekip Touch is able to record (page 101):

- Maximum and medium voltage
- Active, reactive and apparent maximum and medium powers

The type of information given, the available commands and notes are the same as those described for the current measurements.

**NOTES:**

- compared to the current measurements, graphic representation is with respect to $1 U_n$ (with maximum value $1.25 U_n$) for the voltage recordings and with respect to $1 S_n$ (with maximum value $1.25 S_n$) for the power recordings
- if the power measurement is negative, the color of the corresponding bar is different from those with a positive value

Peak factor

The peak factors are real time measurements of the ratio between the peak and RMS values of the phase current; the measurement is supported by the *Harmonic distortion* protection function (page 50).

Measurement	Monitor time	Accuracy	Notes
Peak factor	$0,3 \div 6\text{ In}$	1,5%	“_ _ _” (not available) is indicated for currents outside the range and disconnected sensors

Power factor The power factor is the real time measurement of the ratio between total active power and total apparent power, expressed as $\cos \varphi$.

Measurement	Monitor time	Accuracy	Notes
Power factor	0,5 ÷ 1	2,5% ⁽¹⁾	"_ _ _" (not available) is indicated for: active and/or reactive power not available or outside the admissible ranges

⁽¹⁾ accuracy based on Ekip Touch and Ekip Touch Measuring without Class 1 Power & Energy Metering package; if the Class 1 Power & Energy Metering package is present and for all other Trip unit models, check the indicated performance values from page 107

Energy counters The energy counters are the measurements of the total reactive and apparent active energy, updated every minute.

Measurement	Monitor time	Accuracy
Total active, reactive and apparent energy	1 kWh ÷ 2 TWh; 1 kVARh ÷ 2 TVARh; 1 kVAh ÷ 2 TVAh	2 % ⁽¹⁾

⁽¹⁾ accuracy based on Ekip Touch and Ekip Touch Measuring without Class 1 Power & Energy Metering package; if the Class 1 Power & Energy Metering package is present and for all other Trip unit models, check the indicated performance values from page 107

Reset measurements

The *Energy RESET* command is available in the *Energy* menu for the purpose of resetting the energy counters (page 34).

3 - Class 1 Power & Energy Metering

List and performance Presence of the *Class 1 Power & Energy Metering* package allows higher measuring accuracy to be obtained for the following quantities:

Measurement	Monitor time (min-max)	Normal operating range	Accuracy of read value
Phase currents ⁽⁶⁾ ⁽⁸⁾	0,004 ÷ 64 In	Standard IEC 61557-12, tables 20-22	0,5 % ⁽¹⁾
Internal earth fault current ⁽²⁾	0,08 ÷ 64 In	Standard IEC 61557-12, table 20	0,5 % ⁽¹⁾
Line frequency	30 ÷ 80 Hz ⁽³⁾	$f_n \pm 10\%$ ⁽⁴⁾	$\pm 0,02$ Hz
Total active and apparent power ⁽⁷⁾	$ P_{min} \div P_{max} $ ⁽⁵⁾	Standard IEC 61557-12, tables 8-11-14	1 % ⁽¹⁾
Active and apparent phase power	$ P_{min} \div P_{max} $ ⁽⁵⁾	Standard IEC 61557-12, tables 8-11-14	1 % ⁽¹⁾
Total active and apparent energy	1 kWh ÷ 2 TWh; 1 kVARh ÷ 2 TVARh; 1 kVAh ÷ 2 TVAh	Standard IEC 61557-12, tables 8-11-14	1 % ⁽¹⁾
Power factor	0,5 ÷ 1	Standard IEC 61557-12, table 27	1% ⁽¹⁾

⁽¹⁾ the accuracy values refer to the normal operating intervals and conditions established by IEC 61557-12, for each quantity and class declared

⁽²⁾ available with LSIG versions

⁽³⁾ available for voltage values of over 30 V (with $U_n < 277$ V) or 60 V (with $U_n \geq 277$ V)

⁽⁴⁾ 47 ÷ 55 Hz with $f_n = 50$ Hz; 54 ÷ 66 Hz with $f_n = 60$ Hz

⁽⁵⁾ $P_{min} = 0,5 I_n \times 5$ V; $P_{max} = 3 \times 16 I_n \times 900$ V

⁽⁶⁾ the higher phase currents are also available in the Histograms, Measuring instruments and Measurement summary pages

⁽⁷⁾ the higher total powers are also available in the Measuring instruments and Measurement summary pages

⁽⁸⁾ internal phase current; in the presence of an external Neutral, the accuracy of current I_n is 1%

Functional characteristics The measuring performance of the *Class 1 Power & Energy Metering* package is guaranteed in the following conditions (from table 43 of standard IEC 61557-12):

Characteristic	Value
Classification of performance measuring and monitoring device (PMD) in accordance with chapter 4.3 of the standard	PMD-DD
Temperature	Operating: T = -25°C to +70°C; Storage: T = -30°C to +70°C; Class: K70
humidity and altitude	Up to 90% relative humidity without condensation; From 0 to 2000 meters
Performance class for active energy and power	1

Information page Presence of the *Class 1 Power & Energy Metering* package activates the IEC 61557-12 information page, which can be consulted in the *About* menu



Figure 34

The page shows the activation state of the *Class 1 Power & Energy Metering* package (*Activated/Deactivated*) and the serial numbers of certain accessories installed on the CB for the specific purpose of conforming to the characteristics of the package (electronic units and internal current sensors)

4 - Datalogger

Presentation



The datalogger is a function which allows data associated with a trigger event to be recorded. The following data are recorded:

- Analog measurements: line-to-line voltages and phase currents
- Digital events: protection events or alarms, circuit-breaker status signals, protection trips.

One or two independent recordings can be configured and, via Ekip Connect, all the associated information can be downloaded, displayed and saved.

Function

When the datalogger is enabled and activated (**RESTART**), Ekip Touch continuously acquires data by filling and emptying an internal buffer (**B**).

If a trigger event (**A**) occurs, Ekip Touch interrupts acquisition (**STOP**) immediately or after a time that can be set by the user (**C**) and stores all the data of the window (**D**), which can then be downloaded to a PC for reading and analysis.



IMPORTANT: the function requires an auxiliary voltage supply

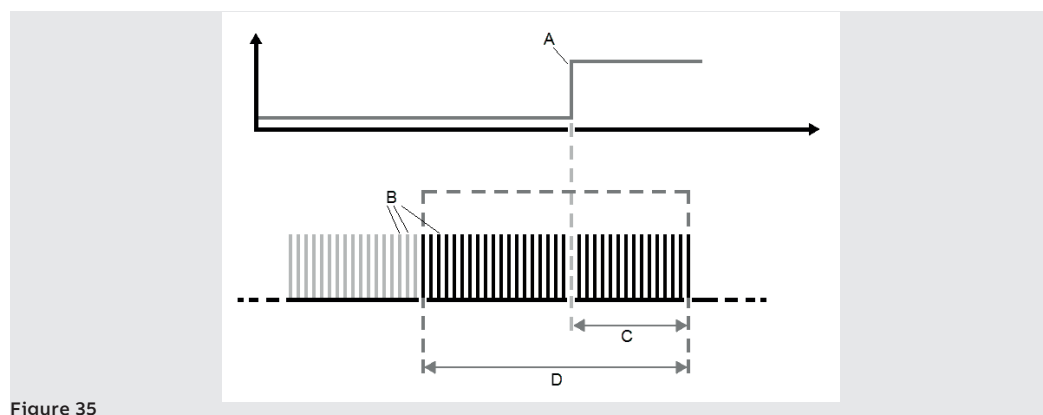

Figure 35

Parameters 1

The parameters and commands of the function are available in the *Settings* menu (page 35).

Parameter	Description	Default
Enable	Activates/deactivates the function and its availability in the parameters menu i NOTE: <i>if the enable command is hidden when at least one datalogger is activated</i>	Off
Num. of Datalogger	Determines the number of recordings (1 or 2) i NOTE: <i>the recordings share the settings of the sampling frequency and type of memory</i> ! IMPORTANT: Change the parameter with interrupted or not started recording	1
Sampling frequency	Establishes the number of samples acquired per second and the recording window. Four options are available: 1200 Hz (window= 13.6 s), 2400 Hz (6.8 s), 4800 Hz (3.4 s), 9600 Hz (1.7 s) i NOTE: • A high frequency allows the data to be analyzed more accurately • if there are two dataloggers, the recording window of each recording is halved	9600 Hz
Datalogger 1 and 2	Menu with the parameters of each Datalogger: trigger event, recording delay and Restart/Stop commands	
Restart and Stop Both	Synchronized start and stop commands of the two dataloggers, valid and available with Num. of Datalogger = 2	

Parameters 2 The *Datalogger 1* and *Datalogger 2* submenus (available if the number of dataloggers selected is: 2) contain the following options:

Parameter	Description	Default
Stop Event	Trigger event at which the recording is to be interrupted; the main protection options (trips, timings, alarms) and the actuator status (open/closed) are displayed. The Custom option can be configured via Ekip Connect	None
Stop delay	Recording interruption delay, calculated from the trigger; the value is given in seconds and can be set within a range: 0 s to 10 s, in 0.01 s steps	0.01 s
Restart	Recording start command	
Stop	Manual recording stop command	

Memory Type

Ekip Connect enables the *Memory Type* (Non volatile/Volatile) to be selected:

- *Non volatile*: Ekip Touch maintains the registration even when off; the life of the internal battery of the unit can be sensibly less than the declared value in the absence of auxiliary power supply.
- *Volatile*: Ekip Touch loses the recording if it is switched off; when the unit is switched on again, the datalogger automatically restarts, losing the previously stored data.

The parameter is configured by default as Non volatile.

Signallings If there is a recording present, Ekip Touch provides the information on the diagnosis bar (DLog1 available).



NOTE: *In the configuration with two dataloggers, the specific indication of the available recording is shown (DLog1 available or DLog2 available)*

Ekip Connect Ekip Connect 3 has two specific areas for the Datalogger function:

- **Datalogger** for configuring the recording parameters with a user-friendly interface, and for downloading the recordings
- **Data Viewer** for opening and consulting the recordings

Both areas are available in the Tools menu of Ekip Connect.

5 - Network Analyzer

Presentation The Network Analyzer function allows you to set voltage and current controls over a long period, in order to analyze your system.

To this purpose, voltages and currents are monitored, so as to find:

- voltage sequences (Over, Under, Pos and neg)
- unbalance between voltages (Unbalance)
- short voltage drops (Interruption) and slow sags (Sag)
- short voltage increases (Spikes) and slow swells (Swell)
- harmonic distortion of voltages and currents (THD)

Each monitoring is associated with control parameters set by the user and updated each time the set control conditions occur.

Parameters The configuration parameters of the counters are available in the *Settings - Network Analyzer* menu (page 35).

The Monitor time parameter, which defines the length of each monitoring session, can also be set in the *Settings* menu.

 **NOTE:** *the parameter is the one used for measuring the maximum currents and voltages*

Main Menu

Parameter	Description	Default
Enable	Activates/deactivates the function and its availability in the parameters menu	Off
I Harmonic Analysis	Activates harmonic analysis of the currents	Off
V Harmonic Analysis	Activates harmonic analysis of the voltages	Off
V Threshold Low	Control threshold of the <i>Under V Th</i> counter The value is given as a percentage of rated voltage U_n and can be set within the range: 75% to 95%, in 5% steps.	85 % U_n
V Threshold High	Control threshold of the <i>Over V Th</i> counter The value is given as a percentage of rated voltage U_n and can be set within the range: 105, 110, 115 % U_n	110 % U_n
Unbalance V Th	Alarm threshold for the <i>Unbalance</i> counter. The value is given as a percentage of rated voltage U_n and can be set within the range: 2% to 10% U_n , in 1% steps.  NOTE: <i>0% =symmetrical and balanced system</i>	3 % U_n
V microinterr. Th	Control threshold of the <i>V microinterr</i> counter. The value is given as a percentage of rated voltage U_n and can be set within the range: 10% to 95% U_n , in 5% steps	95 % U_n
V Spike Threshold	Control threshold of the <i>Spike</i> counter. The value is given as a percentage of U_n and can be set within the range: 105% to 125% U_n , in 5% steps	105 % U_n
Sags	Menu with the control parameters of the voltage sags	
Swells	Menu with the control parameters of the voltage swells	
Harmonics	The submenu, which becomes available by enabling the harmonic current and/or voltage analysis, allows the harmonic control parameters to be configured	

Continued on the next page

Sags Menu

All the thresholds are given as a percentage of rated voltage U_n and can be set from 10% to 95% U_n , in 5% steps.

All the times are given in seconds and can be set within the range: 0.04 s to 60 s, in variable steps

Parameter	Description	Default
V sag Th Short	Control threshold of <i>Sags Short</i> counter	10 % U_n
V sag dur Short	Minimum duration of sag below the Short threshold to validate the count of the <i>Sags Short</i> counter	0,8 s
V sag Th Middle	Control threshold of <i>Sags Middle</i> counter	45 % U_n
V sag dur Middle	Minimum duration of sag below the <i>Middle</i> threshold to validate the count of the <i>Sags Middle</i> counter	0,8 s
V sag Th Long	Control threshold of <i>Sags Long</i> counter	95 % U_n
V sag dur Long	Minimum duration of sag below the Long threshold to validate the count of the <i>Sags Long</i> counter	0,8 s



NOTE: *Ekip Touch* accepts changes to the parameters subject to compliance with the following limitations: $V \text{ sag dur Long} \geq V \text{ sag dur Middle} \geq V \text{ sag dur Short}$

Swells Menu (Swell)

All the thresholds are given as a percentage of rated voltage U_n and can be set from 105% to 125% U_n , in 5% steps.

All the times are given in seconds and can be set within the range: 0.04 s to 60 s, in variable steps

Parameter	Description	Default
V swell Th Short	Control threshold of the <i>Swell Short</i> counter	125 % U_n
V swell dur Short	Minimum duration of swell above the <i>Short</i> threshold to validate the count of the <i>Swell Short</i> counter	0,8 s
V swell Th Long	Control threshold of the <i>Swells Long</i> counter	105 % U_n
V swell dur Long	Minimum duration of swell above the Long threshold to validate the count of the <i>Swells Long</i> counter	0,8 s



NOTE: *Ekip Touch* accepts changes to the parameters subject to compliance with the following limitations: $V \text{ sag dur Long} \geq V \text{ sag dur Middle} \geq V \text{ sag dur Short}$

Harmonics (Current and Voltage)

All the thresholds are given as a percentage and can be set within the range: 5% to 20% (total THD) or: 3% to 10% (single harmonics) in 1% steps.

Menu	Parameter	Description	Default
Current	THD Threshold	Control threshold of the <i>THD Voltages</i> counter	5 %
	Single harmonic th	Control threshold of the single harmonics counters of the voltages	5 %
Voltage	THD Threshold	Control threshold of the <i>THD Current</i> counter	5 %
	Single harmonic th	Control threshold of the single harmonics counters of the currents	5 %

Counters - introduction

The main counters of the function are available in the *Measurements – Network Analyzer* menu, distributed among several sections (page 34).

The extended list of all the measurements is available via Ekip Connect or by connecting to the bus system



NOTE: *the Additional List item in the following paragraphs contains the additional counters that are only present via Ekip Connect; the type of reference counter is given in the heading of the additional tables*

V Sequences and V 3s Sequences

Submenus **V Sequences** and **V 3s Sequences** have the following counters:

Menu	Parameter	Description
V Sequences	V seq pos	Positive sequence of period in progress [V]
	V seq neg	Negative sequence of period in progress [V]
	Last V pos seq	Positive sequence of period preceding the one in progress [V]
	Last V neg seq	Negative sequence of period preceding the one in progress [V]
V 3s Sequence	V seq pos	Positive sequence calculated during the last three seconds [V]
	V seq neg	Negative sequence calculated during the last three seconds [V]
	Unbalance	Voltage unbalance calculated during the last three seconds [%]

Additional List

Counters (Sequences)	Description
Last time stamp	Date and time of last recording of the sequences
Counters (Sequences)	Description
Last value	Voltage unbalance relating to the period in progress [%]
Actual unbalance value	Voltage unbalance relating to the period preceding the one in progress [%]
Last time stamp	Date and time of last recording of the unbalances
Actual number of U.	Counts the number of times that the average value of the ratio between the positive on negative sequence (with direction of rotation 3-2-1) and negative on positive sequence (1-2-3) exceeds the <i>Unbalance V Th</i> threshold; the count refers to the actual day
Actual [day -1 ... day -7] number of U.	Counters relating to the number of unbalances detected in the last seven days of activity, calculated using the internal clock of the unit
Cumulative number of U.	Cumulative counter of all the unbalances detected by the unit (sum of the other counters or to be increased also for the previous days?)



NOTE: *all measurements of unbalances (Not balanced and Unbalance value) saturate at 200%*

THD Current and THD Voltages

The *THD Current* and *THD Voltages* submenus have the following counters:

Menu	Counters	Description
THD Current	L1, L2, L3, Ne	Instantaneous harmonic distortion value of each current phase
THD Voltages	U12, U23, U31	Instantaneous harmonic distortion value of each line-to-line voltage

Over V Th and Under V Th

Certain counters relating to the sequence measurements are available in the *Counters - Day -1* and *Counters - Cumulative* submenus:

Counters	Description
Over V Th	Counts the number of times that the average value of the positive sequence (in the set direction of rotation of the phases: 1-2-3) or negative sequence (in the set direction of rotation of the phases: 3-2-1) exceeds the <i>V Threshold High</i> threshold. The count refers to the reference menu interval (previous day or cumulative)
Under V Th	Counts the number of times that the average value of the positive sequence (in the set direction of rotation of the phases: 1-2-3) or negative sequence (in the set direction of rotation of the phases: 3-2-1) falls below the <i>V Threshold Low</i> threshold. The count refers to the reference menu interval (previous day or cumulative)

Additional List

Counters (Over Voltage)	Description
Last time stamp	Date and time of last recording of the <i>Over V Th</i> counter
Last value	Value of the last swell above the <i>Over V Th</i> [V] threshold
Actual number of O.	<i>Over V Th</i> count for the current day
Actual [day -2 ... day -7] number of O.	<i>Over V Th</i> count of the last seven days of activity, calculated using the internal clock of the unit

Counters (Under Voltage)	Description
Last time stamp	Date and time of last recording of the <i>Under V Th</i> counter
Last value	Value of the last sag below the <i>Under V Th</i> [V] threshold
Actual number of O.	<i>Under V Th</i> count for the current day
Actual [day -2 ... day -7] number of O.	<i>Under V Th</i> count of the last seven days of activity, calculated using the internal clock of the unit

V microinterr. (Interruption)

The *V microinterr* counter should be understood as reduction of the RMS value of the line-to-line voltage below the *V microinterr. Th* set threshold for less than 40 ms (short time voltage sag).

The counter is available in the two submenus *Counters - Day -1* and *Counters - Cumulative* (previous day or cumulative)

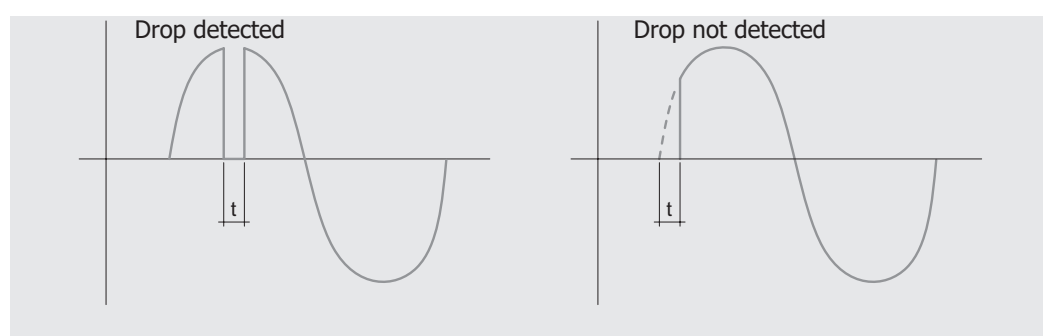

NOTE: Since the counter is based on the RMS value calculation, two rapid voltage sags of equal duration may be evaluated differently, depending on when they occur:

**Additional List**

Counters (Interruptions)	Description
Last instant	Date and time of last recording of the <i>V microinterr</i> counter
Last value	Value of last sag below the <i>V microinterr</i> [V] threshold
Last duration	Value of last sag below the <i>V microinterr</i> [ms] threshold
Actual number of I.	<i>V microinterr</i> count for the current day
Actual [day -2 ... day -7] number of I.	<i>V microinterr</i> count of the last seven days of activity, calculated using the internal clock of the unit

Spikes The *Spikes* counter should be understood as increase of the RMS value of the line-to-line voltage above the set *V Spike Threshold* threshold for less than 40 ms (short time voltage spike).

The counter is available in the two submenus *Counters - Day -1* and *Counters - Cumulative* (previous day or cumulative)



NOTE: Since the counter is based on the RMS value calculation, two rapid voltage spikes of equal duration may be evaluated differently, depending on their amplitude:

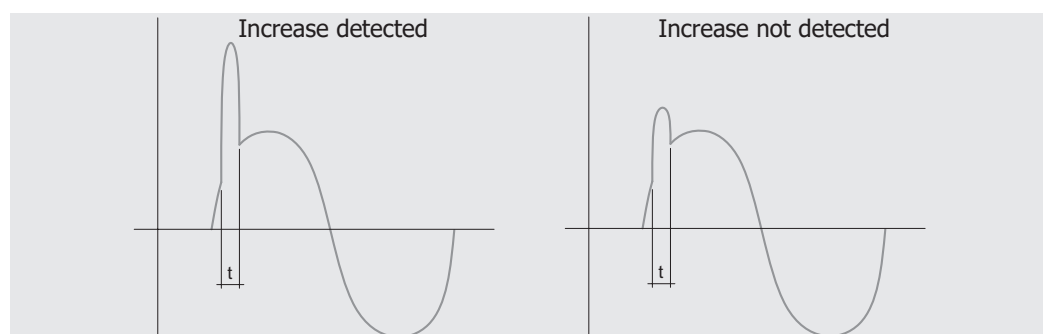

Additional List

Counters (Interruptions)	Description
Last time stamp	Date and time of last recording of the <i>Spikes</i> counter
Last value	Value of last swell above <i>Spikes</i> [V] threshold
Last duration	Duration of last swell above <i>Spikes</i> [ms] threshold
Actual number of S.	<i>Spikes</i> count for the current day
Actual [day -2 ... day -7] number of S.	<i>Spikes</i> count of the last seven days of activity, calculated using the internal clock of the unit

Sags Certain counters relating to sags are available in the *Counters - Day -1* and *Counters - Cumulative* submenus:

Counters (Interruptions)	Description
Sags Short	Counts the number of times that any line-to-line voltage falls below the <i>V sag Th Short</i> threshold for longer than <i>V sag dur Short</i>
Sags Middle	Counts the number of times that any line-to-line voltage falls below the <i>V sag Th Middle</i> threshold for longer than <i>V sag dur Middle</i>
Sags Long	Counts the number of times that any line-to-line voltage falls below the <i>V sag Th Long</i> threshold for longer than <i>V sag dur Long</i>

The count refers to the reference menu interval (previous day or cumulative)



NOTE: since an event may fall under more than one category, only the counter of the main type (Long > Middle > Short) is increased

Additional List

Counters (Interruptions)	Description
Last time stamp	Date and time of last recording of the <i>Sags Short</i> counter
Sags Middle	Value of last sag below the <i>Sags Short</i> [V] threshold
Sags Long	Duration of last sag below the <i>Sags Short</i> [ms] threshold
Actual number of S.	<i>Sags Short</i> count for the current day
Actual [day -2 ... day -7] number of S.	<i>Sags Short</i> count of the last seven days of activity, calculated using the internal clock of the unit

Continued on the next page

Counters (Sags Middle)	Description
Last time stamp	Date and time of last recording of the <i>Sags Middle</i> counter
Sags Middle	Value of last sag below the <i>Sags Middle [V]</i> threshold
Sags Long	Duration of last sag below the <i>Sags Middle [ms]</i> threshold
Actual number of S.	<i>Sags Middle</i> count of the current day
Actual [day -2 ... day -7] number of S.	<i>Sags Middle</i> count of the last seven days of activity, calculated using the internal clock of the unit

Counters (Sags Middle)	Description
Last time stamp	Date and time of last recording of the <i>Sags Long</i> counter
Sags Middle	Value of last sag below the <i>Sags Long[V]</i> threshold
Sags Long	Duration of last sag below the <i>Sags Long[ms]</i> threshold
Actual number of S.	<i>Sags Long</i> count of the current day
Actual [day -2 ... day -7] number of S.	<i>Sags Long</i> count of the last seven days of activity, calculated using the internal clock of the unit

Swells Certain counters relating to swells are available in the *Counters - Day -1* and *Counters - Cumulative* submenus:

Counters (Sags Middle)	Description
Swells Short	Counts the number of times that any line-to-line voltage exceeds the <i>V swell Th Short</i> threshold for longer than <i>V swell dur Short</i>
Swells Long	Counts the number of times that any line-to-line voltage exceeds the <i>V swell Th Long</i> threshold for longer than <i>V swell dur Long</i>

The count refers to the reference menu interval (previous day or cumulative)



NOTE: since an event may fall under more than one category, only the counter of the main type (long > short) is increased

Additional List

Counters (Swells Short)	Description
Last time stamp	Date and time of last recording of the <i>Swells Short</i> counter
Last value	Value of last swell above <i>Swells Short [V]</i> threshold
Last duration	Duration of last swell above <i>Swells Short [ms]</i> threshold
Actual number of S.	<i>Swells Short</i> count for the current day
Actual [day -2 ... day -7] number of S.	<i>Swells Short</i> count of the last seven days of activity, calculated using the internal clock of the unit

Counters (Swells Long)	Description
Last time stamp	Date and time of last recording of the <i>Swells Long</i> counter
Last value	Value of last swell above <i>Swells Long[V]</i> threshold
Last duration	Duration of last swell above <i>Spikes[ms]</i> threshold
Actual number of S.	<i>Swells Long</i> count for the current day
Actual [day -2 ... day -7] number of S.	<i>Swells Long</i> count of the last seven days of activity, calculated using the internal clock of the unit

THD Voltages and Currents

Certain counters relating to harmonic distortion are available in the *Counters - Day -1* and *Counters - Cumulative* submenus:

Counters (Swells Long)	Description
THD Voltages	Counts the total number of minutes in which total distortion exceeds current threshold <i>THD Threshold</i>
THD Current	Counts the total number of minutes in which total distortion exceeds voltage threshold <i>THD Threshold</i>



NOTE: the counters saturate at 65535 minutes (45 days); they can be reset by a service connector command (via Ekip Connect) or via communication from the system bus

Additional List

Counters (Swells Long)	Description
Actual minutes	<i>THD Current</i> count for the current day [min]
Actual [day -2 ... day -7] number of THD C.	<i>THD Current</i> count of the last seven days of activity, calculated using the internal clock of the unit

Counters (Swells Long)	Description
Actual minutes	<i>THD Voltages</i> count for the current day [min]
Actual [day -2 ... day -7] number of THD C.	<i>THD Voltages</i> count of the last seven days of activity, calculated using the internal clock of the unit

Waveforms

The *Network Analyzer - Waveforms* menu provides graphic representations of:

- phase currents L1, L2, L3, Ne (for units configured with 4 phases)
- line-to-line voltages V12, V23, V31

When one of the available quantities is selected, Ekip Touch acquires and displays the waveform

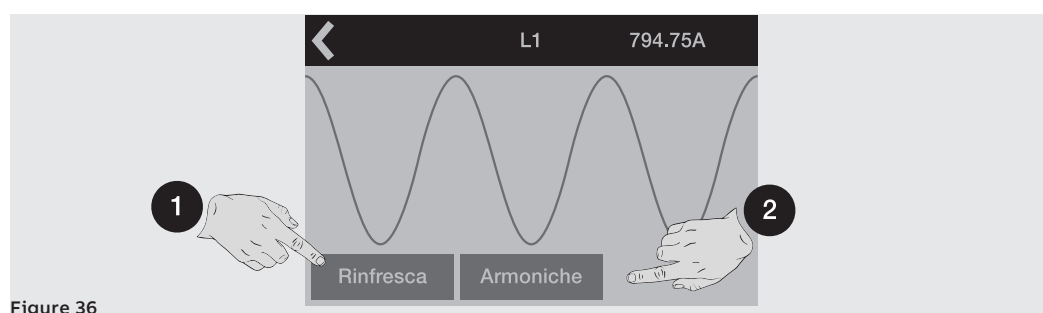

Figure 36

The detected waveform and the value at the time of selection are displayed in the window that appears. A new waveform and the relative measurement can be acquired with the Refresh command (1).

Harmonics

The waveform window will propose the *Harmonics* (2) command if harmonic analysis of currents and/or voltages has been selected. This command accesses the histogram of the harmonics (relating to the grid frequency set in the menu) that make up the waveform.

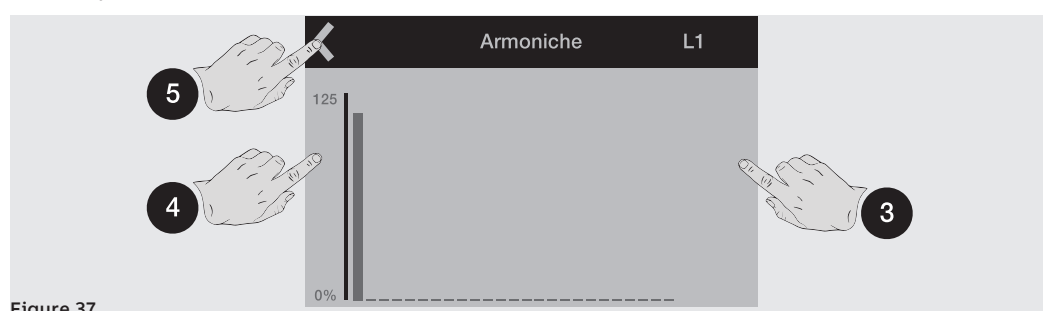

Figure 37

Touch the sides of the display to scroll the harmonics after (3) and before (4) the selected harmonic, displayed on a flashing graph with value shown in the center of the page. The command for exiting the page is at the top left (5).

Ekip Touch - Settings

1 - Main settings

Foreword All the following parameters are available either directly, or from the *Settings* menu, in the conditions established by Ekip Touch on the basis of the version and configuration described.

To correctly address parameters which are present in the menu but not described below:

- Circuit-breaker: Hardware Trip, T Protection, Neutral Protection
- Phase Sequence
- Monitor time
- Network Analyzer
- Datalogger
- Dual Set
- Functions

please consult the *Settings* menu overview (page 35).



WARNING! changes to the settings must be made in the absence of protection alarms

Bluetooth Low Energy - Connection security

The Bluetooth antenna on the Trip unit can be activated in the *Bluetooth Low Energy* menu. This is useful for launching a communication with an external device (tablet, smartphone) according to the Bluetooth Low Energy protocol, via the *EPiC* APP (page 14).

Activation of Bluetooth Low Energy communication requires the Trip unit to be pre-engineered for a wireless connection: security of the data and Bluetooth Low Energy connection between the Trip unit and its device is guaranteed thanks to the *ABB EPiC* application and the pairing configuration described in the next paragraph.



WARNING! It is the customer's sole responsibility to provide and continuously ensure a secure connection between his device and the Trip unit. The plant manager must establish and maintain appropriate measures (such as but not limited to the installation of malware prevention systems, application of authentication measures, his own system and interface against any kind of security breach, unauthorized access, interference, intrusion, loss and/or theft of data or information. ABB and its affiliates are not liable for damages and/or losses related to such security breaches, unauthorized accesses, interference, intrusion, loss and/or theft of data or information, use of APPs other than those allowed.

ABB recommends a few general configurations to strengthen the access of data into the Trip unit:

- activate the access PIN code in the Trip unit configure it with a value differing from the default value
- if parameters need not be written, configure the Trip unit only for parameter readout via bus (*Test bus* parameter = *Off*)
- switch off the Bluetooth Low Energy antenna (*Bluetooth Low Energy-Enable* parameter = *Off*) after use



IMPORTANT: communications via wireless and via service connector function alternatively: if Bluetooth Low Energy is activated there can be no communication with other accessories via the service connector

Bluetooth Low Energy - Parameters

The following parameters are available

Parameter	Description	Default
Enable	Enables/disables Bluetooth Low Energy antenna switch-on and availability of the other parameters in the menu: <ul style="list-style-type: none"> • if <i>On</i>, the antenna comes on, on the basis of the <i>Battery Mode</i> parameter configuration • if <i>Off</i>, the antenna is off 	Off
Battery mode	Defines the switch-on mode of the Bluetooth Low Energy antenna, based on the presence of the devices on the service connector (Ekip T&P, Ekip Programming, Ekip TT); can have two values: <ul style="list-style-type: none"> • --- ; with this option, the state of the antenna depends exclusively on the presence of devices: on if not present; off if present • ON ; with this option, the antenna is switched off for 15 seconds when a device is connected, after which: it remains off if communication with the device has been activated; it comes on if no communication has been activated <p>! IMPORTANT: the typical scenario in which Battery mode should be configured = On is: Ekip Touch + Ekip TT + communication with smartphone activated; in all other cases, including System Update, configure Battery mode = ---</p>	---
Start Pairing	Command which starts Pairing between Trip unit and external device. To perform the operation correctly: <ol style="list-style-type: none"> 1. Press Connect on EPiC APP, select the Trip Unit from among the units in the list and then select Connect again 2. Press Start Pairing in the Trip unit menu, enter the PIN, then press Start Pairing again 3. Press Start Pairing on EPiC APP and confirm the operations until the code request appears 4. Check that the pop up with the Passkey appears on the display of the Trip unit (about 20 seconds) and enter it in EPiC APP 5. The Trip unit will be connected to the external device from this moment on; for the successive re-connections, it will be sufficient to just repeat point 1 <p>i NOTES:</p> <ul style="list-style-type: none"> • execute the procedure within 120 seconds • the command is not available if communication with a device is activated 	---
Decouple devices	Command that deletes the list of devices coupled to the Trip unit <p>i NOTE: the command is not available if communication with a device is activated</p>	---
Version	FW version of the Bluetooth Low Energy module installed on board	---



IMPORTANT: when Bluetooth Low Energy antenna is on, communication on the service connector is not available



IMPORTANT: if Bluetooth is disabled during the order (with the extracode) or disabled by a Service L3 authorized person, the dedicated menu will neither be present, nor visible nor usable. The icons will not be shown on the screen if Bluetooth is disabled

Configuration The *Circuit breaker-Configuration* menu, allowing the presence of the *External neutral* sensor to be activated, is available for the 3P CB (page 206).

Activation of the configuration with *External neutral* (3P + N) enables:

- histograms of phase Ne in the *Histograms* page
- neutral current measurements
- submenu for configuring the Neutral protection (*Neutral Protection*)
- neutral current recording in the case of TRIP

With 3P CB, the parameter is set by default as: 3P.

Line frequency Frequency adjustment is performed to set the installation frequency; the choice is between 50 Hz and 60 Hz.



NOTE: *the measurements are taken on the basis of the set grid frequency: incorrect configuration of the parameter may lead to abnormal measurements and protection*

Ekip Touch is supplied with the parameter setting that suits the ordered configuration.

Modules The *Modules* menu provides various options:

Parameter	Description	Default
Local/Remote	<p>The parameter defines the mode in which the parameters are written in the unit:</p> <ul style="list-style-type: none"> • <i>Local</i>: parameter editing only via the display or service connector • <i>Remote</i>: parameter editing only remotely (Ekip Com modules) <p>NOTES:</p> <ul style="list-style-type: none"> • <i>the Remote mode requires the presence of auxiliary power supply and Ekip Com modules, otherwise it disables automatically</i> • <i>However, the Local/Remote parameter can still be edited in the Remote mode</i> 	Local
Local bus	<p>The parameter enables communication between the Trip unit and modules installed via terminal box or outside the unit to be activated.</p> <p>Correct communication between unit and modules is confirmed by:</p> <ul style="list-style-type: none"> • population of the <i>Modules</i> menu with all the modules connected • Power Leds of the modules on and synchronized like the power led of Ekip Touch • absence of Local Bus alarm in the diagnosis bar 	Off
Ekip Signalling 1K	Menu with the parameters of the module (page 200)	
Ekip Measuring	Menu with the parameters of the module <i>Measurement</i> (page 128)	
-	Menu of every module connected and detected (from page 132)	
Functions	Access to the <i>LOCAL Switch On</i> and <i>RESET signaling</i> functions (from page 78)	

Test Bus The parameter allows parameter editing via the service connector to be enabled/disabled, thereby limiting the possibility of configuring all the options on the display (in the Local mode) or via modules *Ekip Com* (in the Remote mode).

Disabling the parameter, Local mode and using the PIN allow security against undesired modification by unauthorized persons to be increased.



NOTE: with Test Bus= Off, communication via service connector is still guaranteed (reading enabled)

Ekip Touch is supplied with the parameter set to: On.

System The *System* menu provides various options:

Parameter	Description	Default
Date	Setting the current date	
Time	Setting the current time	
Language	Setting the language in display menus	English
PIN	PIN setting (page 39)	00001



IMPORTANT: setting and checking Date and Time is important for all the recording functions (trips or measurements); in the event of date and time glitches, reset and if necessary replace the battery inside Ekip Touch (page 19).

View The *View* menu provides various options:

Parameter	Description	Default
<i>TFT orientation</i>	Enables the orientation of the <i>Alarms List</i> , <i>Measuring Instruments</i> and <i>Main Measurements</i> pages to be set. The options are: Horizontal, Vertical clockwise, Vertical counter-clockwise	Horizontal
<i>Customer page</i>	Allows you to activate a supplementary information page, which can be accessed by pressing the iTEST button twice from any page with a diagnosis bar. The information on the new page can be configured via Ekip Connect (page 123)	Off
<i>Ammeter Phase</i>	Allows the current to be displayed in the <i>Measuring instruments</i> page to be set from among the following options: I _{max} , I ₁ , I ₂ , I ₃ , N _e (only in the 4P or 3P + N configuration)	I _{max}
<i>Voltmeter Phase</i>	Allows the voltage to be displayed in the <i>Measuring instruments</i> page to be set from among the following options: V _{max} , V ₁₂ , V ₂₃ , V ₃₁	V _{max}

Maintenance The parameter allows an alarm, concerning maintenance of the unit, to be enabled/disabled. (page 103). Ekip Touch is supplied with the parameter set to: On.

MLRIU The *MLRIU* parameters are available with Ekip M Touch for the *Motor Protections* functions (page 69).



NOTE: to ensure correct operation, check where applicable: presence and status of the outgoing connections, those towards the Trip unit of Ekip CI and the relative output contact (O61)

Parameters

Parameter	Description	Default
<i>Open Mode</i>	<p>Allows the TRIP mode to be set (page 40):</p> <ul style="list-style-type: none"> • <i>Heavy</i>: in the event of a TRIP, it is controlled by the Trip coil of the CB • <i>Normal</i>: contact O61 of the <i>Ekip CI</i> module is opened in the event of a TRIP <p>NOTES:</p> <ul style="list-style-type: none"> • the TRIP for protections <i>G</i> or <i>I</i> always involves the Trip coil command, regardless of the <i>Open Mode</i> configuration • in the <i>Normal</i> mode, if the Trip unit detects the presence of a fault even after the open command sent to O61, a command is also sent to the Trip coil of the CB 	Standard
<i>Autoreclosure Enabled</i>	When <i>Open Mode</i> = <i>Normal</i> , allows re-closing of contact O61 to be activated after a TRIP due to protection L (On)	Off
<i>Motor Class</i>	Allows the trip class of the motor to be selected from among: 5E, 10E, 20E, 30E (page 69)	30E
<i>Contactors Delay</i>	Defines the time waited, after the open command of contact O61, before the fault is considered to be still present and action is taken by sending a command to the Trip coil of the CB. The value is given in seconds and can be set within the range: 0.1 s to 1 s, in 0.1 s steps	0,1
<i>Autoreclosure Time</i>	Defines the time waited after the open command of contact O61, before this latter is closed. The value is given in seconds and can be set within the range: 1 s to 1000 s, in 1 s steps	60

2 - Additional settings

Presentation Via the service connector (via Ekip Connect) or system bus communication, you can:
A description of the different functions is given below.

Programmable States There are sixteen independent programmable states identified by the letters A, B, C, D, E, F, G, H, I, L, M, N, O, P, Q, R, offering different solutions for event control.

Each programmable status can have two values: True or False. There are also various configuration parameters available:

- *Trigger*: event or combination of several status activation events (up to 24, in AND or OR logic configuration).
- *On Delay*: status activation delay calculated from trigger presence onwards.
- *Off Delay*: status de-activation delay calculated from trigger absence onwards.



NOTE: the status activates if the trigger is present for longer than the On delay setting and de-activates if the trigger is absent for longer than the Off delay setting

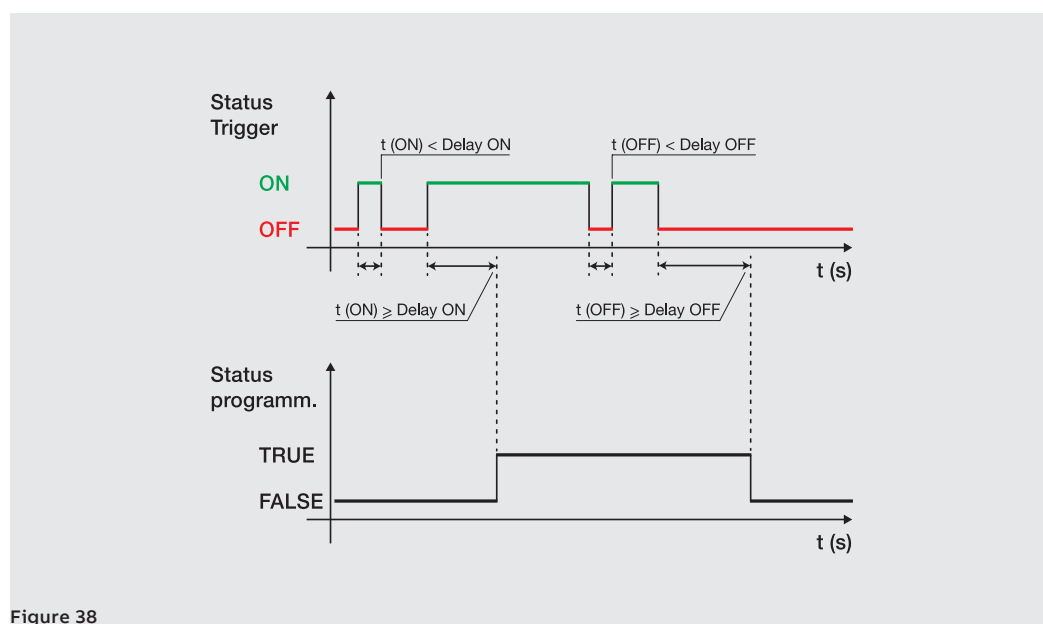

Figure 38

The statuses can be used with external module *Ekip Signalling 10K*, on Link Bus or with the programmable functions, so as to convey the required signaling combination to the contacts.

Filters A measuring filter (*V0 filter*) can be activated with V0 external neutral connection

If the filter is activated, the measurements and specific protections of V0 are dealt with differently: Ekip Touch applies a pass-band filter to the signal so as to measure the fundamental component only (50 or 60 Hz).

TAG Name, User data Tags that can be programmed by the user to facilitate remote identification of units.



NOTE: the Name TAG and communication address form the identification used by Ekip Connect for the connected devices

Customers Page	Enabling and fields for editing the Customers page (5 information lines) that can be viewed on the display of the unit (page 120).
Installation	Date of installation of unit
Load Profile Time	The counter indicates the time that has elapsed since the last reset of the energy measurements. It is active and updated in the presence of at least one of the following: auxiliary supply or supply by Ekip T&P.
Led Alive	<p>The parameter enables the behavior of the Power led of the Trip unit and of all the connected modules to be modified; if activated (<i>Alive Mode on</i>), the Power leds act in the following way:</p> <ul style="list-style-type: none"> • <i>Ekip Touch</i>: flashes at 0.5 Hz frequency • <i>Modules</i>: if there are no communication errors, they synchronize with the led of Ekip Touch. <p>If deactivated, the Power leds on the respective devices come on with a steady light.</p>
Open/Close Remote Direct Command	<p>The parameter controls 2 different command packages for remote opening and closing:</p> <ul style="list-style-type: none"> • <i>Enabled</i>: command 7 and 8 valid (direct Open and Close commands). • <i>Disabled</i>: commands 7 and 8 not valid: in this case, remote opening and closing can still be obtained using the programmable YC COMMAND and YO COMMAND functions and the <i>Request circuit-breaker opening</i> and <i>Request circuit-breaker closing</i> commands
Change Double Set of parameters always	<p>If activated, enables the set of parameters (<i>Adaptive Protections</i>) to be changed even when timing alarms are in progress.</p> <p>Disabled by default.</p>
Repeat zone selectivity S/I/2I/MCR/G HW	<p>If Enabled, zone selectivity HW signals propagation logic applies in accordance with the table in the QT1 technical application notes. 1SDC007100G0205</p> <p>If Disabled, the HW selectivity signal is not propagated by Ekip Touch</p>
Zone selectivity input functions	<p>The zone selectivity inputs and certain of the outputs can be configured in this section:</p> <ul style="list-style-type: none"> • <i>Standard</i>: input or output operation as per standard zone selectivity logic; all selectivity functions are set as Standard. (1SDC007100G0205 or 1SDC007401G0201) • <i>Customized</i>: the event that activates the zone selectivity input or output can be selected. <p> IMPORTANT: in the Customized configuration, the only zone selectivity activation event is the one set and standard selectivity operation is therefore not active (changes should only be made by expert technical personnel).</p>
Glitch	The commands of Glitches 16 to 23 activate the respective glitch registers, which can be used for customizing programmable functions or output contacts.
Wizard Reset	Reset Wizard: the Wizard window appears on Ekip Touch when powered-up the next time and allows some of the parameters of the unit to be entered.

Ekip Touch - Test

1 - Test

Presentation The test area can be accessed on the display; the commands available in this area allow certain functions of the Trip unit to be checked; details of all the commands available in the Test menu are given below (page 36).

Ekip T&P with Ekip Connect has a *Test Protections* section where the presence of current or voltage alarm signals can be simulated and times and trips can be checked.

Autotest The Autotest command starts an automatic sequence of the display and leds so as to enable their operation to be checked.

The sequence comprises the following test phases:

1. Screen with message "www.abb.com".
2. Darkening of the display.
3. Color sequence with red, green, blue bands, with gradual increase of backlighting
4. Lighting up, for one second, of the Warning and Alarm leds.



NOTE: *auxiliary power supply must be present in order to check the gradual increase of backlighting*

Trip Test Selection of the *Trip test* command accesses the dedicated page where the operator is asked to press the **iTEST** key to confirm the test operation.

An open command is transmitted to the Trip coil of the CB when the key is released.



IMPORTANT:

- **the open command is sent with the circuit-breaker closed and in the absence of current**
- **following a command, the user is responsible for checking the effective change in status of the actuator and the information displayed: make sure that there are no alarms on the diagnosis bar before performing the test**



NOTE: *to reset the TRIP signal, go back to the HOME page and press the iTEST key or transmit a TRIP RESET command (via Ekip Connect or remotely)*

Test CB Selection of the *Test CB* command accesses a submenu with the *Open CB* and *Close CB* commands. The commands allow opening coil YO and closing coil YC to be activated, respectively: a window with the message "Test Executed" confirms that the command has been transmitted correctly.

Correct operation of the entire command system (Trip unit and opening and closing coils) is checked by opening and closing the circuit-breaker.



IMPORTANT:

- **the open and close commands of the coils only function when the Trip unit is on and powered by an auxiliary supply**
 - **make sure that the coils are connected to the supply source**
 - **release operation is checked by the commands: coil faults are not detected by the test**
-

Ekip CI The menu activates in the presence of module *Ekip CI*, auxiliary power supply and local bus enabled. The *Autotest* command is available in the menu; its selection activates the test of the leds and output contact O61 in sequence:

1. Led reset and closing of contact O61 (if open)
2. Lighting up of all leds in sequence and successive switch-off
3. Opening of the O61 contact, switching on and off of the O61 led
4. Re-closing of O61 contact



IMPORTANT:

- **the autotest sequence also includes transmission of the open command of the output contact: the user is responsible for checking that it has opened correctly**
- **the test sequence always ends with the closing of the O61 contact, regardless of the starting condition: verify that the change of status following the test does not create problems in your installation.**

Ekip Signalling 2K The menu activates in the presence of module *Ekip Signalling 2K*, auxiliary power supply and local bus enabled.



NOTE: a menu is available for each *Ekip Signalling 2K* module present, up to a maximum of three

The *Autotest* command is available in each submenu; it activates the automatic output test (Contacts and leds), input test (leds) and provides for the following operations:

1. Resetting of output contacts (= open) and leds (= off).
2. Lighting up of all leds in sequence (output and input)
3. Closing and switch-off in sequence of the two output contacts while the relative leds come on.
4. Reset initial conditions



IMPORTANT: the Autotest command closes the contacts regardless of the configuration set by the user: the user is responsible for making the devices connected to the Ekip Signalling 2K modules secure, checking that the contacts have closed properly and that the leds have come on

Ekip Signalling 1K The menu includes the *Autotest* command which, in the presence of *Ekip Signalling 1K / MM* and auxiliary power supply, commands an automatic open-close-open sequence of the module contact.



IMPORTANT: the command closes the contact regardless of the configuration set by the user: the user is responsible for making the devices connected to the *Ekip Signalling 1K* module secure and checking that the contact has closed properly

ZoneSelectivity The menu has one or two sections, visibility of which depends on the protections available and enabled:

Submenus	Reference selectivity	Outputs/Inputs managed
S Selectivity	S, S2, D (Forward)	SZi (DFi), SZo (DFo)
G Selectivity	G, Gext, MDGF, D (Backward)	GZi (DBi), GZo (DBo)

Each submenu has three fields for checking selectivity inputs and outputs:

Field	Description
Input	Provides the status of the selectivity input (On/Off)
Force output	Selectivity output activated
Force Output	Selectivity output deactivated

Consult the description of the putting into service procedure when checking the selectivity contacts (page 17).

Ekip Touch - Default

1 - Ekip TOUCH default parameters

Foreword Given the number of parameters available with Ekip Touch, each chapter describing their characteristics also includes their default value settings.

The configurations of the main parameters are given below.

Protections All Ekip Touch models are supplied with the protections (and relative correlated functions) off, with the exception of the protections listed below:

Protection	Configuration
L (excluding Ekip M Touch)	I1= 1 In; t1= 48 s; curve= t= k/I ² ; prealarm: 90% I1
L (only Ekip M Touch)	I1= 0,4 In; t1= 45 s (Class= 20E); Thermal Memory= On; Prealarm: 90 % I1
I	I3= 4 In; startup= OFF
Harmonic distortion	On

Parameters Unless different specifications are requested when ordering, all Ekip Touch models are supplied with the following configurations:

Parameters	Configuration
Frequency	50 Hz (IEC) / 60 Hz (UL)
Configuration	3P (3P circuit-breaker) / 4P (4P circuit-breaker)
Neutral	Off (3P circuit-breaker) / 50% (4P circuit-breaker)
Rated voltage	400 V
Power flow	Bottom → Top
Phase Sequence	1-2-3
Local bus	Off
Mode	Local
Language	English
Bluetooth Low Energy	Off
Password	00001
Home page	Histograms
Led Alive	Disabled
View	Horizontal
Maintenance	On
Test Bus	On
Modbus RTU par	Address: 247; baudrate: 19.2 kbit/s
Profibus	Address: 125
DeviceNet™	MAC ID: 63; baudrate: 125 kbit/s
Modbus TCP/IP	Static IP: 0.0.0.0

Internal electronic accessories

1 - Rating Plug

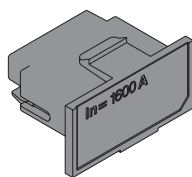

The *Rating Plug*, supplied with the trip unit establishes the rated current I_n required by the measuring range and for setting the current protections (with reference to I_n).

It is installed on a dedicated front connector which can be accessed by the user.

The trip unit continuously checks for the presence of the *Rating Plug* and signals its absence or any assembly or installation errors.

If a new model is installed, the Trip unit displays the request for installation when first powered.

In Ekip Touch, field *Nom.Curr* in the *About-Circuit breaker* menu displays the I_n quantity read by the unit.

Replacement

The module can be replaced by the user; any *Rating Plug* with maximum rated current equal to the current of the sensor in the unit can be installed.



WARNING!

- with original Rating Plug less than or equal to 400 A it is possible to mount models up to 400 A
- models up to 250 A at 630 A can be installed if the original Rating Plug is 500 A or 630 A

Further details about assembly and the Rating Plug installation procedure are available in ABB Library, particularly in document [1SDH002011A1505](#).



IMPORTANT: to avoid alarms or undesired trips, the Rating Plug must be replaced when Trip unit is off, the CB open and in the absence of primary currents and voltages.

2 - Measurement

- Presentation** The *Measuring* module allows the following measurements to be taken:
- Voltage (RMS measurement of line-to-line voltages and phase voltages in the applicable cases)
 - Frequency of the voltages
 - Power and energy, also using the phase current measurements.



NOTE: *measurement performance is described on page 104 and 107.*

If used in conjunction with *Ekip Synchrocheck*, it is also able to recognize whether the synchronization conditions between external sockets and external contacts are able to allow the synchronization contact to close (see chapter dedicated to *Ekip Synchrocheck* from page 167).

- Configurations available** The module is connected directly to the internal sockets of the CB.
- In the 3P + N configuration, the external neutral voltage (V0) can be connected to the trip unit so as to measure and protect the residual voltage. Consult circuit diagrams [1SDM000005A1001](#).

- Electrical characteristics** The *Measurement* module works correctly in the electrical conditions described on page 16.

- Menu** The module parameters are available in the menu *Settings - Modules - Ekip Measuring*:

Parameter	Description	Default
<i>Un Setting Mode</i>	Selects the rated voltage value selection mode: <ul style="list-style-type: none"> • Table: value editable in preset steps • Volt: value editable within the range in 1 V steps 	Table
<i>Secondary voltage</i>	Available in the presence of a transformer; defines the secondary voltage of the transformer. The value is expressed in absolute value (volt) and can be set within the 100 V to 230 V range, in steps that depend on the Un Setting Mode parameter setting.	100 V
<i>Positive Power flow</i>	Defines the power flow required for D protection; there are 2 options available (page 62): <ul style="list-style-type: none"> • High → Low: power flows from high terminals to low terminals (load connected low) • Low → High: power flows from low terminals to high terminals (load connected high) 	Bottom → Top
<i>Neutral connection</i>	Available with 3P CB; allows the presence of the external Neutral to be enabled. <p> NOTE: <i>presence of the neutral activates phase voltage measurement</i></p>	Absent

When Un Setting Mode is set according to Table the voltage parameters can have the following values:

Parameter	Voltage values with adjustment in steps
<i>Rated voltage</i>	100 V, 115 V, 120 V, 190 V, 208 V, 220 V, 230 V, 240 V, 277 V, 347 V, 380 V, 400 V, 415 V, 440 V, 480 V, 500 V, 550 V, 600 V, 660 V, 690 V

- About** The *About-Modules* menu contains the specific menu of the module with the serial number and version of the module itself.

- Test** The dielectric test is described in the Installation instructions [1SDH002011A1001](#), [1SDH002011A1002](#).

External electronic accessories

1 - Introduction to the electronic accessories

Operating conditions Ekip Synchrocheck, *Ekip Com*, *Ekip Signalling* and *Ekip CI* function correctly:

- In the presence of auxiliary supply voltage
- With the circuit-breaker in the Racked-in position (if the CB version is withdrawable)

The limitations listed below apply in all the other cases:

Modul / Condition	Ekip Synchrocheck	Ekip Com	Ekip Signalling	Ekip CI
Module power supply absent	Synchronization contact: open	Communication: absent	Output contacts: open	Output contact: maintains previous position
CB in Test ⁽¹⁾⁽²⁾ position	Synchronism: not available ⁽⁴⁾	Communication: active	Inputs and output contacts: available	Inputs and output contact: functioning
CB in DISCONNECTED ⁽¹⁾⁽³⁾ position	Synchronism: not available ⁽⁴⁾	Communication: partially active ⁽⁵⁾	Inputs and output contacts: partial available ⁽⁶⁾	Output contact: maintains previous position

⁽¹⁾ the description refers to the module when correctly on and with the CB in the indicated position

⁽²⁾ in the Test position, the Trip unit is connected to the modules and all information is available on the display or via external communication

⁽³⁾ in the Racked-out position, connection and communication between Trip unit and modules is interrupted. Information is not available/valid

⁽⁴⁾ due to voltage not connected to the internal sockets

⁽⁵⁾ see System Interface, INFORMATION WITH PROTECTION TRIP UNIT DISCONNECTED section (next page)

⁽⁶⁾ the outputs only function correctly if configured as: input status (of module itself) or non-communication with Trip unit. For all other configurations, the module forces the Outputs as per Contact Type parameter (NO, NC).

System Interface Document 1SDH002031A1101.zip, describing how to use the Ekip Com communication modules correctly, is available in ABB library; the file contains:

Document	Description
1SDH002031A1101.pdf	Guidelines with details about how to put the communication modules into service, with reference to the protocols and supporting documents
1SDH002031A1101.xlsx	Table with the references of all the registers for parameters, controls, measurements, etc.

The .zip file contains the files for supplementing Ekip Touch in the available communication networks, with the specific Ekip Com module and an IMPORTANT file with notes on how to use the files:

File ⁽¹⁾⁽²⁾	Protocol / Ekip Com module
ABBS0E7F.gsd + EkiDPB.bmp	File .gsd and module image for configuring <i>Ekip Com Profibus DP</i>
Ekip_COM_EtherNetIP_M4_vx_xx.eds	File .eds for configuring <i>Ekip Com EtherNet/IP™</i>
Ekip_COM_DeviceNet_vx_xx.eds	File .eds for configuring <i>Ekip Com DeviceNet™</i>
ABBECxxxx_Ed1.icd ABBECxxxx_Ed2.icd	File .icd for configuring <i>Ekip Com IEC 61850</i>
GSDML-Vx.xx.xml	File .xml for configuring <i>Ekip Com Profinet</i>

⁽¹⁾ The files are also valid for the respective Redundant versions.

⁽²⁾ Check the Firmware version of your module so as to choose the file with the correct configuration.

2 - Ekip Cartridge

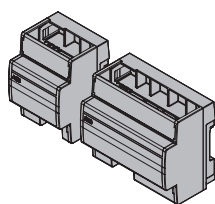

Ekip Cartridge is an external accessory. It can be installed on standard 35 mm DIN rail (DIN EN 50022 type TS 35x15 mm) and allows Ekip Touch to be connected to other external accessories:

- all cartridge modules (e.g.: Ekip Supply, Ekip Com, etc)
- contact for signaling racked-in/racked-out state, in the case of withdrawable CBs

Models The two different models available allow two or four modules to be connected, respectively.



IMPORTANT: one of the modules must always be Ekip Supply

Connections Ekip Cartridge has two terminal boxes:

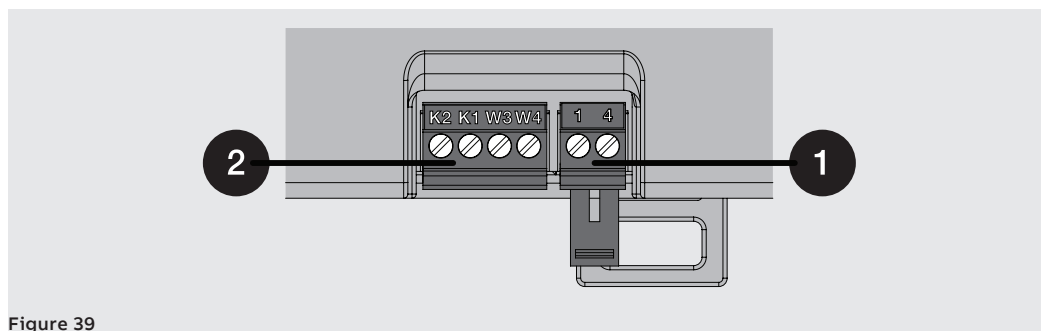



Figure 39

Connector	Description
1	Terminal for connecting the racked-in/racked-out status contact (AUP).  NOTE: <i>Ekip Cartridge is supplied by default with a jumper on the terminal</i> To use the racked-in/racked-out status signal, remove the jumper in the connector and connect the cables from the fixed part of the CB.
2	Terminal for connecting Ekip Cartridge to Ekip Touch. A list and description of the Pins is given below: <ul style="list-style-type: none"> • K2: Supply output for Ekip Touch (-) • K1: Supply output for Ekip Touch (+) • W3: CAN Bus • W4: CAN Bus

Access to all the external connections is available in the respective modules, on the upper side of *Ekip Cartridge*.

Mounting To connect the module to Ekip Touch, please consult document [1SDH002009A1503](#).

3 - Ekip Supply

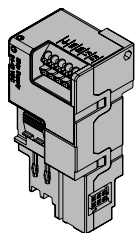

Ekip Supply is an accessory supply module. It is available in two models, depending on the incoming voltage to be provided.

It performs three functions:

- supplies auxiliary power to Ekip Touch
- allows the modules installed inside *Ekip Cartridge* to be connected to Ekip Touch
- acts as a bridge for the Local Bus between Ekip Touch and the external electronic accessories (e.g. *Ekip Signalling 10K* and *Ekip Multimeter*)

The module has a Power led to signal the presence of incoming power supply:

- off: no supply
- on (steady): supply present

Electrical characteristics

Model	Ekip Supply 24-48VDC	Ekip Supply 110-240 VAC/DC
Power supply voltages	21,5 ÷ 53 VDC	105 ÷ 265 VAC/DC
Frequency	--	45 ÷ 66Hz
Maximum power consumption without modules ⁽¹⁾	3 W	3 VA/W
Maximum power consumption with modules ⁽²⁾	10 W	10 VA/W
Maximum inrush current	2 A for 20 ms	2 A for 20 ms

⁽¹⁾ *Ekip Touch* with just *Ekip Supply*

⁽²⁾ *Ekip Touch* with three modules connected

Connections

The module must be assembled in the first slot of *Ekip Cartridge*.

For references about the connection and terminals, please consult document [1SDM000005A1001](#); use AWG 22-16 cables with 1.4 mm maximum outer diameter for the external cabling.

To connect the module to *Ekip Cartridge*, please consult document [1SDH002009A1503](#).

4 - Ekip Com Modbus RTU

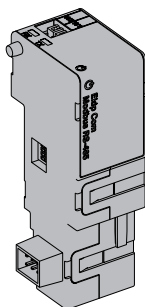

Ekip Com Modbus RTU is a communication accessory which allows Ekip Touch to be integrated into an RS-485 network with Modbus RTU communication protocol, remote supervision and monitoring functions, in two different modes, master and slave.

You can perform the following operations remotely:

- read Ekip Touch measurements and information
- manage certain controls, including opening and closing the actuator (MOE-E)
- access information and parameters not available on the display
- If connected to a withdrawable version of the circuit-breaker, the allows the racked-in/racked-out status to be detected



NOTE: *the remote open and close commands of the circuit-breaker can only be executed if Ekip Touch is in the Remote configuration*

The System Interface document is available for mapping the module in its communication network. All the required communication and command details are listed in the document (page 129).

Accessories *Ekip Cartridge* and *Ekip Supply* are required in order to connect *Ekip Modbus RTU* to Ekip Touch (page 130 ,131).

Models Two different modules compatible with the Modbus RTU protocol are available: *Ekip Com Modbus RTU* and *Ekip Com Modbus RTU Redundant*.

The modules are identical in terms of characteristics and installation methods, except for: display menus, cabling and addresses for system communication, which are specific for each module.



NOTE: *if different indications are not given, the information in the next chapter is valid for both models*

The two modules can be connected at the same time to Ekip Touch so as to expand the potential of the unit (e.g. for applications where high grid reliability is required).



IMPORTANT: *each Ekip Touch can be fitted with only one module per type. The configuration with two modules of the same model is not allowed (example: two Ekip Com Modbus RTU Redundant)*

Connections To connect the module to its communication network and for references about the terminals, please consult document [1SDM000005A1001](#); use Belden 3105A type cables or equivalent for the external cabling.

To connect the module to *Ekip Supply* and *Ekip Cartridge*, please consult document [1SDH002009A1503](#).

Power supply *Ekip Com Modbus RTU* is supplied directly by the *Ekip Supply* module to which it is connected.



NOTE: *communication between Ekip Touch and the module is interrupted in the absence of auxiliary power supply*

Interface the module has three signaling leds:

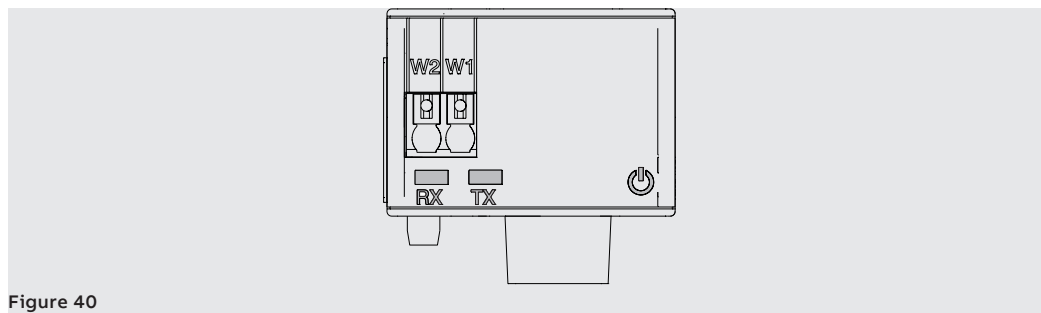

Figure 40

LEDs	Description
Power	<p>Signals the on status and correct communication with Ekip Touch:</p> <ul style="list-style-type: none"> • off: module off • on steady or flashing synchronized with the Power led of Ekip Touch: module on and communication with Trip unit present. • flashing not synchronized with the Power led of Ekip Touch (2 fast flashes per second): module on and communication with Trip unit absent
Rx	<p>Indicates the status of the communication between network master and module (slave):</p> <ul style="list-style-type: none"> • off: Modbus RTU communication not activated • on with fast flashes: Modbus RTU communication activated
Tx	<p>Indicates the status of the communication between network master and module (slave):</p> <ul style="list-style-type: none"> • off: communication between Modbus RTU not activated • on with fast flashes: Modbus RTU communication activated

Configurations

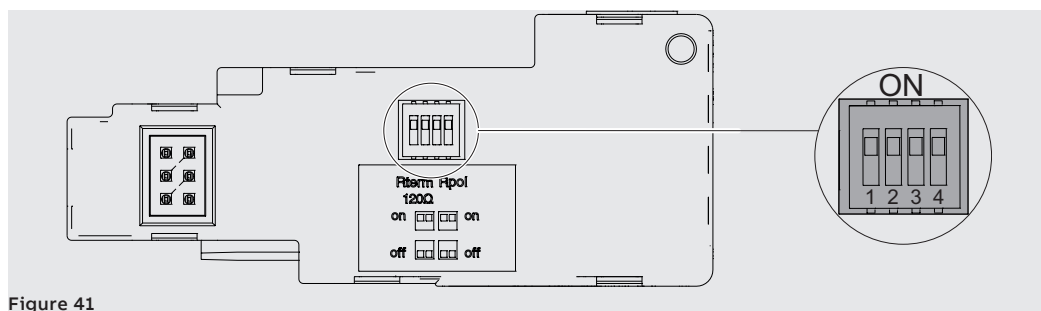

Figure 41

Resistor	Dip	Description	Default
Rterm	1 and 2	120 Ω termination resistor Move dip-switches 1 and 2 to the ON position to connect Rterm	Off
Rpol	3 and 4	220 Ω pull-up or pull-down resistor Move dip-switches 3 and 4 to the ON position to connect Rpol	Off

! **IMPORTANT: move the dip-switches before connecting the module to Ekip Supply and the communication network**

Configurations via menu Local bus activation, which is essential for starting the communication between module and Ekip Touch, is available in the *Settings* menu (page 120).

Two areas are activated if Ekip Touch detects the module correctly:

- information area in the About-Modules menu, containing the software version and serial number of the module
- specific configuration area in the Settings-Modules menu, where the following communication parameters can be configured

Parameter	Description	Default
<i>Serial address</i>	Module address; 1 to 247 range available  IMPORTANT: devices connected to the same network must have different addresses	247 / 246 ⁽¹⁾
<i>Baudrate</i>	Data transmission speed; 3 options are available: 9600 bit/s, 19200 bit/s, 38400 bit/s	19200 bit/s
<i>Physical protocol</i>	Defines the stop and parity bit; 4 options are available: <ul style="list-style-type: none"> • 8,E,1 = 8 data bits, 1 EVEN parity bit, 1 STOP bit • 8,O,1 = 8 data bits, 1 ODD parity bit, 1 STOP bit • 8,N,2 = 8 data bits, no parity bit, 2 STOP bits • 8,N,1 = 8 data bits, no parity bit, 1 STOP bit 	8,E,1

⁽¹⁾ 247 default of the Ekip Com Modbus RTU module; 246 default of the Ekip Com Modbus RTU Redundant module

Remote configurations The operating configuration can be changed from slave to master via the service connector (via Ekip Connect) or via system bus communication so as to integrate the module into an interactive data exchange network (see description of Ekip Com Hub, page 159).



IMPORTANT:

- **In the Master configuration, the module does not allow data exchange as in the normal Slave function**
- **the presence of several masters in the same network can cause faulty operation**

Remote information Certain additional information concerning the version and status of the module is available via the service connector (via Ekip Connect) or by communication via system bus; the information includes: HW and Boot version, CRC status (correctness of the SW in the module).

5 - Ekip Com Profibus DP

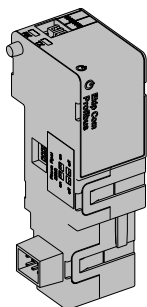

Ekip Com Profibus DP is a communication accessory which allows Ekip Touch to be integrated into an RS-485 network with Profibus communication protocol, with remote supervision and monitoring functions.

The module is configured as a Slave and remotely, you can:

- read Ekip Touch measurements and information
- manage certain controls, including opening and closing the actuator
- access information not available on the display
- If connected to a withdrawable version of the circuit-breaker, the allows the racked-in/racked-out status to be detected



NOTE: *the remote open and close commands of the circuit-breaker can only be executed if Ekip Touch is in the Remote configuration*

The System Interface document is available for mapping the module in its communication network. All the required communication and command details are listed in the document (page 129).

Accessories *Ekip Cartridge* and *Ekip Supply* are required in order to connect *Ekip Com Profibus DP* to Ekip Touch (page 130, 131).

Models Two different modules compatible with the Profibus protocol are available: *Ekip Com Profibus DP* and *Ekip Com Profibus DP Redundant*.

The modules are identical in terms of characteristics and installation methods, except for: display menus, cabling and addresses for system communication, which are specific for each module.



NOTE: *if different indications are not given, the information in the next chapter is valid for both models*

The two modules can be connected at the same time to Ekip Touch so as to expand the potential of the unit (e.g. for applications where high grid reliability is required).



IMPORTANT: *each Ekip Touch can be fitted with only one module per type. The configuration with two modules of the same model is not allowed (example: two Ekip Com Profibus DP Redundant)*

Connections For references about the connection and terminals, please consult document [1SDM000005A1001](#); use Belden 3079A type cables or equivalent for the external cabling.

To connect the module to *Ekip Supply* and *Ekip Cartridge*, please consult document [1SDH002009A1503](#).

Power supply *Ekip Com Profibus DP* is supplied directly by the *Ekip Supply* module to which it is connected.



NOTE: *communication between Ekip Touch and the module is interrupted in the absence of auxiliary power supply*

Interface the module has three signaling leds:

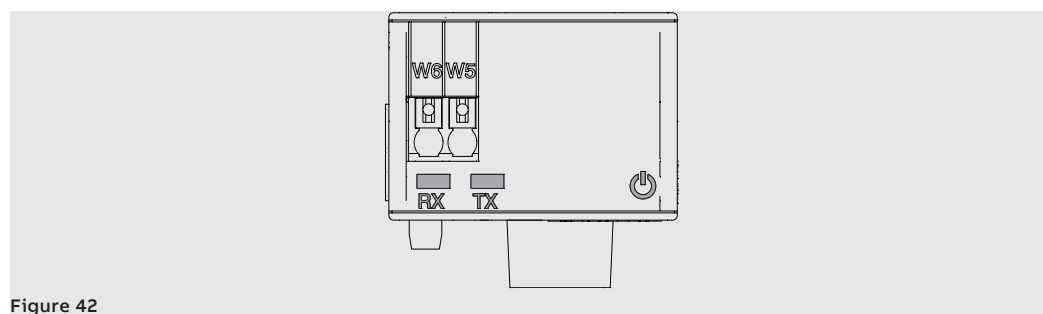

Figure 42

Continued on the next page

LEDs	Description
Power	Signals the on status and correct communication with Ekip Touch: <ul style="list-style-type: none"> • off: module off • on steady or flashing synchronized with the Power led of Ekip Touch: module on and communication with Trip unit present. • flashing not synchronized with the Power led of Ekip Touch (2 fast flashes per second): module on and communication with Trip unit absent
Rx	Indicates the status of the communication between network master and module (slave): <ul style="list-style-type: none"> • off: communication between master and module not activated • on steady: communication between master and module activated
Tx	Indicates the status of the communication between network master and module (slave): <ul style="list-style-type: none"> • off: communication between master and module not activated • on flashing: communication between master and module activated

Configurations Resistors can be connected to the RS-485 bus by configuring the dip-switches at the side of the module:

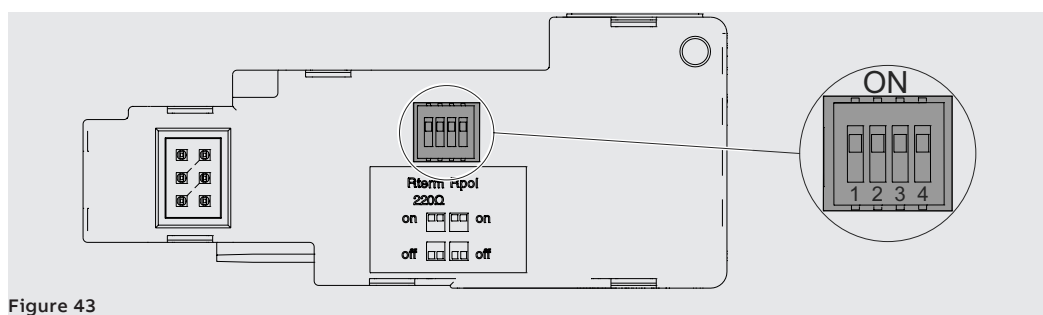

Figure 43

Resistor	Dip	Description	Default
Rterm	1 and 2	220 Ω termination resistor Move dip-switches 1 and 2 to the ON position to connect Rterm	Off
Rpol	3 and 4	390 Ω pull-up or pull-down resistor Move dip-switches 3 and 4 to the ON position to connect Rpol	Off



IMPORTANT: move the dip-switches before connecting the module to Ekip Supply and the communication network

Configurations via menu Local bus activation, which is essential for starting the communication between module and Ekip Touch, is available in the *Settings* menu (page 35).

Two areas are activated if Ekip Touch detects the module correctly:

- information area in the *About - Modules* menu, containing the software version and serial number of the module
- specific configuration area in the *Settings - Modules* menu, where the following communication parameters can be configured:

Parameter	Description	Default
Serial address	Module address; 1 to 126 range available IMPORTANT: devices connected to the same network must have different addresses	125 / 124 ⁽¹⁾

⁽¹⁾ 125 default of the Ekip Com Profibus DP module; 124 default of the Ekip Com Profibus DP Redundant module

Remote configurations Additional parameters can be accessed via the service connector (via Ekip Connect) or via a system bus communication:

Parameter	Description	Default
<i>Data access mode</i>	Defines Dataset (acyclic data) access mode <ul style="list-style-type: none"> • each individual acyclic register can be accessed in the Legacy mode, using Slot and Index fields • <i>_IX _</i> only complete blocks can be accessed in the Dataset mode; Slot is fixed at 0 and Index defines the block reference See System Interface for details.	Legacy access
<i>Cyclic data endianness</i>	Establishes whether the register of the cyclic data item is configured in Big endian or Little endian.	Little endian
<i>Acyclic data endianness</i>	Establishes whether the register of the acyclic data item is configured in Big endian or Little endian.	Big endian

Remote information Certain additional information concerning the version and status of the module is available via the service connector (via Ekip Connect) or by communication via system bus; the information includes: HW and Boot version, CRC status (correctness of the SW in the module).

6 - Ekip Com DeviceNet™

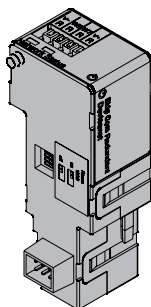

Ekip Com DeviceNet™ is a communication accessory which allows Ekip Touch to be integrated into a CAN network with DeviceNet™ communication protocol, with remote supervision and monitoring functions.

The module is configured as a Slave and remotely, you can:

- read Ekip Touch measurements and information
- manage certain controls, including opening and closing the actuator
- access information and parameters not available on the display
- If connected to a withdrawable version of the circuit-breaker, the allows the racked-in/racked-out status to be detected



NOTE: *the remote open and close commands of the circuit-breaker can only be executed if Ekip Touch is in the Remote configuration*

The System Interface document is available for mapping the module in its communication network. All the required communication and command details are listed in the document (page 129).

Accessories *Ekip Cartridge* and *Ekip Supply* are required in order to connect *Ekip Com DeviceNet™* to Ekip Touch (page 130, 131).

Models Two different modules compatible with the DeviceNet™ protocol are available: *Ekip Com DeviceNet™* and *Ekip Com DeviceNet™ Redundant*.

The modules are identical in terms of characteristics and installation methods, except for: display menus, cabling and addresses for system communication, which are specific for each module.



NOTE: *if different indications are not given, the information in the next chapter is valid for both models*

The two modules can be connected at the same time to Ekip Touch so as to expand the potential of the unit (e.g. for applications where high grid reliability is required).



IMPORTANT: *each Ekip Touch can be fitted with only one module per type. The configuration with two modules of the same model is not allowed (example: two Ekip Com DeviceNet™ Redundant)*

Connections For references about the connection and terminals, please consult document [1SDM000005A1001](#); use Belden 3084A type cables or equivalent for the external cabling.

To connect the module to *Ekip Supply* and *Ekip Cartridge*, please consult document [1SDH002009A1503](#).

Power supply *Ekip Com DeviceNet™* is supplied directly by the *Ekip Supply* module to which it is connected.

To function correctly, the DeviceNet™ bus must be supplied on terminals V+ and V- with a signal of over 12 VDC.



NOTE:

- the ABB PLC with DeviceNet (CM575-DN) communication module provides V+ V- supply
- communication between Ekip Touch and the module is interrupted in the absence of power supplies from Ekip Supply and on the supply terminals of the bus

Interface the module has three signaling leds:

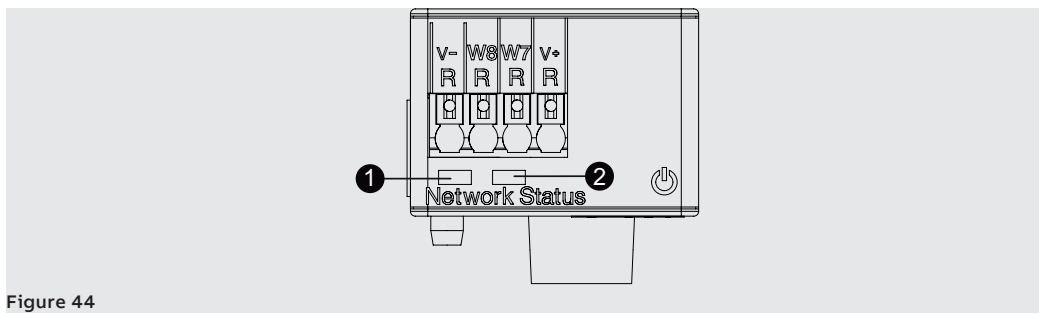

Figure 44

LEDs	Description
Power	Signals the on status and correct communication with Ekip Touch: <ul style="list-style-type: none"> • off: module off • on steady or flashing synchronized with the Power led of Ekip Touch: module on and communication with Trip unit present. • flashing not synchronized with the Power led of Ekip Touch (2 fast flashes per second): module on and communication with Trip unit absent
Network Status (1)	Indicates the communication status on the bus: <ul style="list-style-type: none"> • off: device off line (with Status led off) ⁽¹⁾, or in the error condition (with Status led on) • on steady: device on line, and assigned to a master (operating condition) • on flashing: device on line, but not assigned to a master (device ready to communicate)
Network Status (2)	Indicates the communication status on the bus: <ul style="list-style-type: none"> • Off: no error. • On fixed: device in bus off, or Network Power absent. • On flashing: I/O connection (cyclic data) in timeout

⁽¹⁾ the device has not yet sent the Duplicate ID sequence in line

Configurations Resistors can be connected to the CAN bus by configuring the dip-switches at the side of the module:

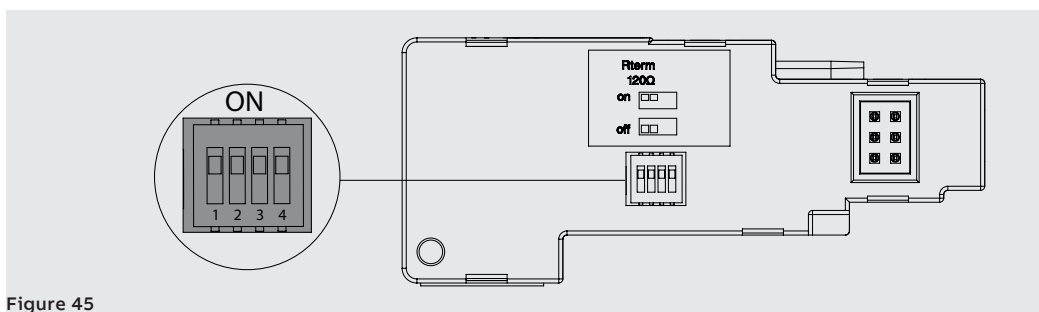

Figure 45

Resistor	Dip	Description	Default
Rterm	1 and 2	120 Ω termination resistor Move dip-switches 1 and 2 to the ON position to connect Rterm	Off



IMPORTANT:

- move the dip-switches before connecting the module to Ekip Supply and the network
- the termination resistors must never be included in the nodes; inclusion of this capacitance could lead to a network with improper termination (impedance too high or too low), which could potentially cause a failure. For example, removal of a node comprising a termination resistor could lead to network failure
- the termination resistors must never be installed at the end of a drop line but only at the ends of the main trunk line

Configurations via menu Local bus activation, which is essential for starting the communication between module and Ekip Touch, is available in the *Settings* menu (page 35).

Two areas are activated if Ekip Touch detects the module correctly:

- information area in the *About - Modules* menu, containing the software version and serial number of the module
- specific configuration area in the *Settings - Modules* menu, where the following communication parameters can be configured:

Parameter	Description	Default
<i>MAC Address</i>	Module address; 1 to 63 range available  IMPORTANT: devices connected to the same network must have different addresses	63 / 62 ⁽¹⁾
<i>Baudrate</i>	Data transmission speed; 3 options are available: 125 kbit/s, 250 kbit/s, 500 kbit/s	125 kbit/s

⁽¹⁾ 63 default of the Ekip Com DeviceNet™ module; 62 default of the Ekip Com DeviceNet™ Redundant module

Remote configurations Additional parameters can be accessed via the service connector (via Ekip Connect) or via a system bus communication:

Parameter	Description	Default
<i>Class ID</i>	Defines the addressing class of the module, either 8 or 16 bits.	8-bit Class ID
<i>Bus-Off Behavior</i>	Defines the behavior of the module following loss of communication (Bus-Off), with a choice between Standard (supply reset is awaited if the communication is lost) and Advanced (the module attempts to reset itself if it detects the error status).	DeviceNet standard

Remote information Certain additional information concerning the version and status of the module is available via the service connector (via Ekip Connect) or by communication via system bus; the information includes: HW and Boot version, CRC status (correctness of the SW in the module).

7 - Ekip Com Modbus TCP

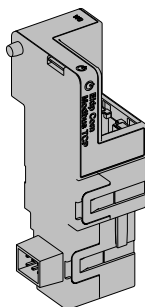

Ekip Com Modbus TCP is a communication accessory which allows Ekip Touch to be integrated into an Ethernet network with Modbus TCP communication protocol, with remote supervision and monitoring functions.

The module is configured as master and remotely, you can:

- read Ekip Touch measurements and information
- manage certain controls, including opening and closing the actuator
- access information and parameters not available on the display
- If connected to a withdrawable version of the circuit-breaker, the allows the racked-in/racked-out status to be detected



NOTE: *the remote open and close commands of the circuit-breaker can only be executed if Ekip Touch is in the Remote configuration*

The System Interface document is available for mapping the module in its communication network. All the required communication and command details are listed in the document (page 129).

Accessories *Ekip Cartridge* and *Ekip Supply* are required in order to connect *Ekip Com Modbus TCP™* to Ekip Touch (page 130, 131).

Depending on the parameter settings, described in the next pages, the ports used by the module are:

Port	Service	Notes
502/tcp	Modbus TCP	Valid for the Modbus TCP mode
319/udp	IEEE 1588	Valid with IEEE 1588 protocol enabled
20/udp		
68/udp	DHCP client	DHCP client enabled alternatively as: <i>Static address = On</i>

Safety and cyber security

Since the module allows the actuator connected to Ekip Touch and access to the data in the unit to be checked, it can only be connected to networks equipped with all the necessary security and prevention measures against unauthorized access (for example, the network of the control system of an installation).



IMPORTANT:

- **it is the customer's sole responsibility to provide and continuously ensure a secure connection between the module and customer network or any other network (as the case may be). The plant manager must establish and maintain appropriate measures (such as but not limited to the installation of firewalls, application of authentication measures, encryption of data, installation of antivirus programs, etc.) to protect the product, the network, the customer system and interface against any kind of security breaches, unauthorized access, interference, intrusion, loss and/or theft of data or information. ABB and its affiliates are not liable for damages and/or losses related to such security breaches, unauthorized accesses, interference, intrusion, loss and/or theft of data or information.**
- **The module cannot be connected directly to the Internet. Only connect to dedicated Ethernet networks with Modbus TCP communication protocol**

Models

Two different modules compatible with the Modbus TCP protocol are available: *Ekip Com Modbus TCP* and *Ekip Com Modbus TCP Redundant*.

The modules are identical in terms of characteristics and installation methods, except for: display menus, cabling and addresses for system communication, which are specific for each module.



NOTE: *if different indications are not given, the information in the next chapter is valid for both models*

The two modules can be connected at the same time to Ekip Touch so as to expand the potential of the unit (e.g. for applications where high grid reliability is required).



IMPORTANT: each Ekip Touch can be fitted with only one module per type. The configuration with two modules of the same model is not allowed (example: two Ekip Com Modbus TCP Redundant)

Connections For references about the connection and terminals, please consult document [1SDM000005A1001](#); a cable of the Class 6 S/FTP type (Class 6 with double screening S/FTP) must be used for the communication bus.

To connect the module to *Ekip Supply* and *Ekip Cartridge*, please consult document [1SDH002009A1503](#).

Power supply *Ekip Com Modbus TCP* is supplied directly by the *Ekip Supply* module to which it is connected.



NOTE: communication between *Ekip Touch* and the module is interrupted in the absence of auxiliary power supply

Interface the module has three signaling leds:

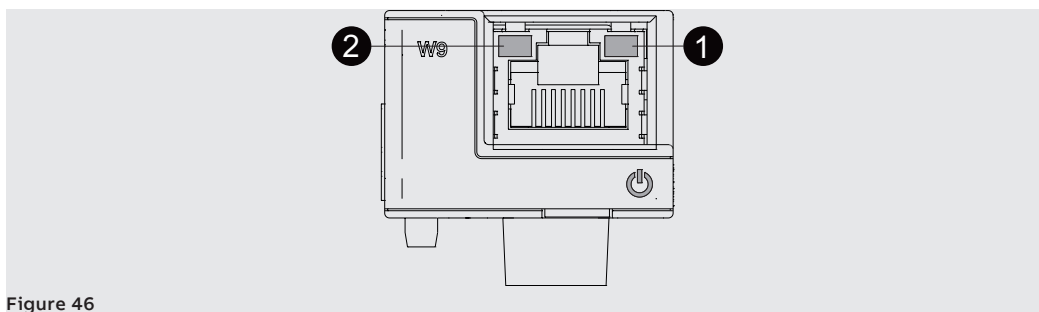

Figure 46

LEDs	Description
Power	Signals the on status and correct communication with Ekip Touch: <ul style="list-style-type: none"> • off: module off • on steady or flashing synchronized with the Power led of Ekip Touch: module on and communication with Trip unit present. • flashing not synchronized with the Power led of Ekip Touch (2 fast flashes per second): module on and communication with Trip unit absent
Link (1)	Indicates the communication state: <ul style="list-style-type: none"> • off: incorrect connection, signal absent. • on steady: connection correct
Activity (2)	Indicates the communication state: <ul style="list-style-type: none"> • off: no activity on line • flashing: activity on line present (receiving and/or transmitting)

Configurations via menu Local bus activation, which is essential for starting the communication between module and Ekip Touch, is available in the *Settings* menu (page 117).

The following communication parameters can be configured if the module has been correctly detected by Ekip Touch in the *Settings-Modules* menu:

Parameter	Description	Default
<i>Static IP address ON</i>	Defines whether the module has the dynamic (Off) or static (On) IP address. Se = On all the associated parameters are enabled	Off
<i>Static address IP address</i>	Enables the static IP to be selected	0.0.0.0
<i>Static Network Mask</i>	Enables the subnet mask to be selected	0.0.0.0
<i>Static Gateway address</i>	When there are several subnets, enables the IP address of the node to which the module is connected to be selected	0.0.0.0

Information in menu The following information will be available in the About-Modules menu if Ekip Touch has detected the module correctly:

Information	Description
<i>SN and version</i>	Identifier and SW version of the module
<i>IP address</i>	Address of the module, assigned to the module by a DHCP server at the time of connection to the network in the case of configuration with a dynamic IP, or can be set via the menu in the event of a static IP.  NOTE: without a DHCP server, the module automatically adopts a random IP address within the 169.254.xxx.xxx range
<i>Network Mask</i>	Subnet mask; identifies the method for recognizing the subnet to which the modules belong and enables modules to be searched for within a defined set of recipients.
<i>Gateway address</i>	IP address of the node to which the module is connected, in the presence of several subnets
<i>TCP Client 1, 2, 3</i>	IP addresses of the client devices connected to the module (in the Server mode)
<i>MAC address</i>	Address assigned by ABB, with OUI (Organizationally Unique Identifier) equal to ac:d3:64, which uniquely identifies the manufacturer of an Ethernet device

Remote configurations

Additional parameters can be accessed via the service connector (via Ekip Connect) or via a system bus communication:

Parameter	Description	Default
Client/Server	Parameter for changing the configuration of the module from Server Only to Client and Server and for integrating it into an interactive data exchange network (see Ekip Com Hub on page 159)  IMPORTANT: if Client/Server, the module allows data exchange like a normal Server function	Server only
IEEE 1588 enable	Allows the IEEE 1588 protocol for distribution of the clock and synchronization signal to be enabled ⁽¹⁾ .	OFF
Master IEEE 1588	Enables the module to be set up as a master in the the network segment to which it belongs (synchronization clock).	OFF
IEEE 1588 delay mechanism	Allows the data exchange mode between module and master, either Peer-to-Peer or End-to-End, to be selected.	End-to-End
SNTP Client enable	Allows the SNTP protocol for distribution of the clock and synchronization signal to be enabled ⁽¹⁾	OFF
Force Static IP Address	Allows the network server that supplies the SNTP to be set.	0.0.0.0
Time zone	Defines the time zone to be used for synchronism	+00:00
Daylight Saving Time	Used to select whether daylight saving time is present (ON) or not (OFF) in the country to which the synchronization time refers	OFF
Disabilita Gratuitous ARP	Permits (Enabled ARP) the periodic generation of a Gratuitous ARP message, used by Ekip Connect to rapidly find the modules via Ethernet scan without knowing the IP address beforehand	ARP Enabled
Access protected by password	Enables the writing operations performed via the network to be protected by a password (Request password)	Standard mode
IEEE 1588 Boundary clock	Parameter useful if an IEEE 1588 GrandMaster clock is not available: • If enabled (ON), the module is seen as an IEEE1588 master clock by all the slaves/devices in the same local network, even when the source of external synchronism is different from IEEE 1588 (SNTP for example) • If disabled (OFF) the module benefits from the synchronism of the master in its own network)	OFF
Enable package Limitation	Enables the Rate limiter function, which limits the number of packages entering the module from the network, to be activated/deactivated	Disable

⁽¹⁾ Enable IEEE 1588 and Enable SNTP client must not be enabled at the same time

⁽²⁾ the parameter can only be changed via system bus in the remote configuration

Remote information

Additional information can be accessed via the service connector (via Ekip Connect) or via a system bus communication:

Information	Description
Boot and HW version	General module information
Flash CRC status e result	Information about the correctness of the SW in the module
Stato Ekip Link	Signals Ethernet cable connection errors
SNTP Server Error	Error in communication with SNTP server
SNTP Server Synchronisation	State of synchronism with SNTP server
IEEE 1588 status	Valid with Master IEEE 1588= ON, notifies the presence (Slave or PTP Master Active) or absence (PTP Master but Passive) of the higher level master

8 - Ekip Com Profinet

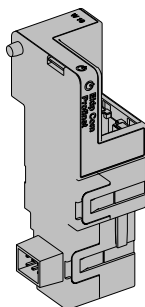

Ekip Com Profinet is a communication accessory which allows Ekip Touch to be integrated into an Ethernet network with Profinet communication protocol, with remote supervision and monitoring functions.

The module is configured as master and remotely, you can:

- read Ekip Touch measurements and information
- manage certain controls, including opening and closing the actuator (MOE-E)
- access information not available on the display
- If connected to a withdrawable version of the circuit-breaker, the allows the racked-in/racked-out status to be detected



NOTE: *the remote open and close commands of the circuit-breaker can only be executed if Ekip Touch is in the Remote configuration*

The System Interface document is available for mapping the module in its communication network. All the required communication and command details are listed in the document (page 129).

The ports used by the module are:

Ethertype	Port	Service	Notes
0x88CC	-	LLDP	Link Layer Discovery Protocol
0x8892 (Profinet)	-	Profinet IO	Specific for real time communications (RT)
0x0800	34964/udp	Profinet-cm (Context manager)	DCE/RPC

Accessories *Ekip Cartridge* and *Ekip Supply* are required in order to connect *Ekip Com Profinet* to Ekip Touch (page 130, 131).

Safety and cyber security

Since the module allows the actuator connected to Ekip Touch and access to the data in the unit to be checked, it can only be connected to networks equipped with all the necessary security and prevention measures against unauthorized access (for example, the network of the control system of an installation).



IMPORTANT:

- **it is the customer's sole responsibility to provide and continuously ensure a secure connection between the module and customer network or any other network (as the case may be). The plant manager must establish and maintain appropriate measures (such as but not limited to the installation of firewalls, application of authentication measures, encryption of data, installation of antivirus programs, etc.) to protect the product, the network, the customer system and interface against any kind of security breaches, unauthorized access, interference, intrusion, loss and/or theft of data or information. ABB and its affiliates are not liable for damages and/or losses related to such security breaches, unauthorized accesses, interference, intrusion, loss and/or theft of data or information.**
- **The module cannot be connected directly to the Internet. Only connect to dedicated Ethernet networks with Profinet communication protocol**

Models

Two different modules compatible with the Profinet protocol are available: *Ekip Com Profinet* and *Ekip Com Profinet Redundant*.

The modules are identical in terms of characteristics and installation methods, except for: display menus, cabling and addresses for system communication, which are specific for each module.



NOTE: *if different indications are not given, the information in the next chapter is valid for both models*

The two modules can be connected at the same time to Ekip Touch so as to expand the potential of the unit (e.g. for applications where high grid reliability is required).



IMPORTANT: each Ekip Touch can be fitted with only one module per type. The configuration with two modules of the same model is not allowed (example: two Ekip Com Profinet Redundant)

Connections For references about the connection and terminals, please consult document [1SDM000005A1001](#); a cable of the Class 6 S/FTP type (Class 6 with double screening S/FTP) must be used for the communication bus.

To connect the module to *Ekip Supply* and *Ekip Cartridge*, please consult document [1SDH002009A1503](#).

Power supply *Ekip Com Profinet* is supplied directly by the *Ekip Supply* module to which it is connected.



NOTE: communication between *Ekip Touch* and the module is interrupted in the absence of auxiliary power supply

Interface the module has three signaling leds:

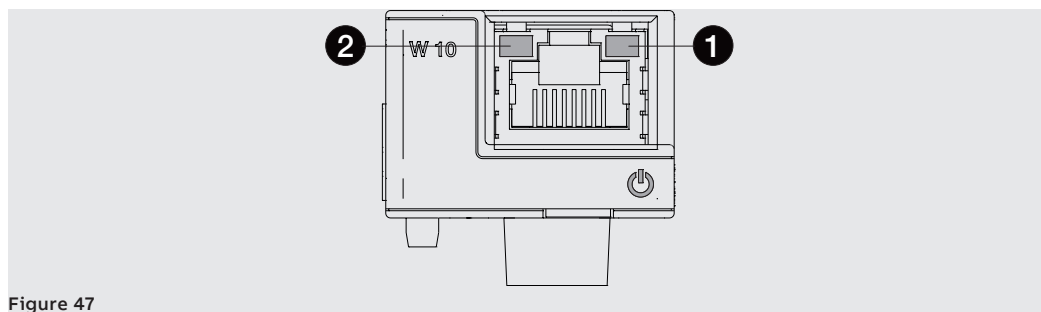

Figure 47

LEDs	Description
Power	Signals the on status and correct communication with Ekip Touch: <ul style="list-style-type: none"> • off: module off • on steady or flashing synchronized with the Power led of Ekip Touch: module on and communication with Trip unit present • flashing not synchronized with the Power led of Ekip Touch (2 fast flashes per second): module on and communication with Trip unit absent.
Link (1)	Indicates the communication state: <ul style="list-style-type: none"> • off: incorrect connection, signal absent. • on steady: connection correct
Activity (2)	Indicates the communication state: <ul style="list-style-type: none"> • off: no activity on line • flashing: activity on line present (receiving and/or transmitting)

Configurations via menu Local bus activation, which is essential for starting the communication between module and Ekip Touch, is available in the *Settings* menu (page 35).

The following information will be available in the *About-Modules* menu if Ekip Touch has detected the module correctly:

Information	Description
<i>SN and version</i>	Identifier and SW version of the module
<i>MAC address</i>	Address assigned by ABB, with OUI (Organizationally Unique Identifier) equal to ac:d3:64, which uniquely identifies the manufacturer of an Ethernet device

Remote configurations Additional parameters can be accessed via the service connector (via Ekip Connect) or via a system bus communication:

Parameter	Description	Default
<i>Data access mode</i>	Defines Dataset (acyclic data) access mode <ul style="list-style-type: none"> • each individual acyclic register can be accessed in the Legacy mode using the Slot, Subslot and Index fields (with Slot fixed at 3) • only complete blocks can be accessed in the Dataset mode; Slot is fixed at 0, Subslot at 1 and Index defines the block reference See System Interface for details.	Legacy
<i>Cyclic data endianness</i>	Establishes whether the register of the cyclic data item is configured in Big endian or Little endian.	Little endian
<i>Acyclic data endianness</i>	Establishes whether the register of the acyclic data item is configured in Big endian or Little endian.	Big endian

Remote information Certain integrative information concerning the version and state of the module is available via service connector (via Ekip Connect) or through communication via system bus, i.e., HW and Boot version, CRC state (correctness of SW in module), DCP Name, network settings (IP address, Network Mask, Gateway address)

9 - Ekip Com EtherNet/IP™

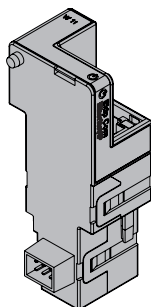

Ekip Com EtherNet/IP™ is a communication accessory which allows Ekip Touch to be integrated into an Ethernet network with EtherNet/IP™ communication protocol, with remote supervision and monitoring functions.

The module is configured as master and remotely, you can:

- read Ekip Touch measurements and information
- manage certain controls, including opening and closing the actuator (MOE-E)
- access information and parameters not available on the display
- If connected to a withdrawable version of the circuit-breaker, the allows the racked-in/racked-out status to be detected



NOTE: *the remote open and close commands of the circuit-breaker can only be executed if Ekip Touch is in the Remote configuration*

The System Interface document is available for mapping the module in its communication network. All the required communication and command details are listed in the document (page 129).

Depending on the parameter settings, described in the next pages, the ports used by the module are:

Port	Protocol	Notes
44818	TCP	Encapsulation Protocol (example: ListIdentity, UCMM, CIP Transport Class 3)
44818	UDP	44818 UDP Encapsulation Protocol (example: ListIdentity)
2222	UDP	2222 UDP CIP Transport Class 0 or 1
68/udp	DHCP Client	DHCP client enabled alternatively as <i>Static address = On</i>

Accessories *Ekip Cartridge* and *Ekip Supply* are required in order to connect *Ekip Com EtherNet/IP™* to Ekip Touch (page 130, 131).

Safety and cyber security

Since the module allows the actuator connected to Ekip Touch and access to the data in the unit to be checked, it can only be connected to networks equipped with all the necessary security and prevention measures against unauthorized access (for example, the network of the control system of an installation).



IMPORTANT:

- **it is the customer's sole responsibility to provide and continuously ensure a secure connection between the module and customer network or any other network (as the case may be). The plant manager must establish and maintain appropriate measures (such as but not limited to the installation of firewalls, application of authentication measures, encryption of data, installation of antivirus programs, etc.) to protect the product, the network, the customer system and interface against any kind of security breaches, unauthorized access, interference, intrusion, loss and/or theft of data or information. ABB and its affiliates are not liable for damages and/or losses related to such security breaches, unauthorized accesses, interference, intrusion, loss and/or theft of data or information.**
- **The module cannot be connected directly to the Internet. Only connect to dedicated Ethernet networks with EtherNet/IP™ communication protocol**

Models Two different modules compatible with the EtherNet/IP™ protocol are available: *Ekip Com EtherNet/IP™* and *Ekip Com EtherNet/IP™ Redundant*.

The modules are identical in terms of characteristics and installation methods, except for: display menus, cabling and addresses for system communication, which are specific for each module.



NOTE: *if different indications are not given, the information in the next chapter is valid for both models*

The two modules can be connected at the same time to Ekip Touch so as to expand the potential of the unit (e.g. for applications where high grid reliability is required).



IMPORTANT: each Ekip Touch can be fitted with only one module per type. The configuration with two modules of the same model is not allowed (example: two Ekip Com EtherNet/IP™ Redundant)

Connections

For references about the connection and terminals, please consult document [1SDM000005A1001](#); a cable of the Class 6 S/FTP type (Class 6 with double screening S/FTP) must be used for the communication bus.

To connect the module to *Ekip Supply* and *Ekip Cartridge*, please consult document [1SDH002009A1503](#).

Power supply *Ekip Com EtherNet/IP™* is supplied directly by the *Ekip Supply* module to which it is connected.



NOTE: communication between *Ekip Touch* and the module is interrupted in the absence of auxiliary power supply

Interface the module has three signaling leds:

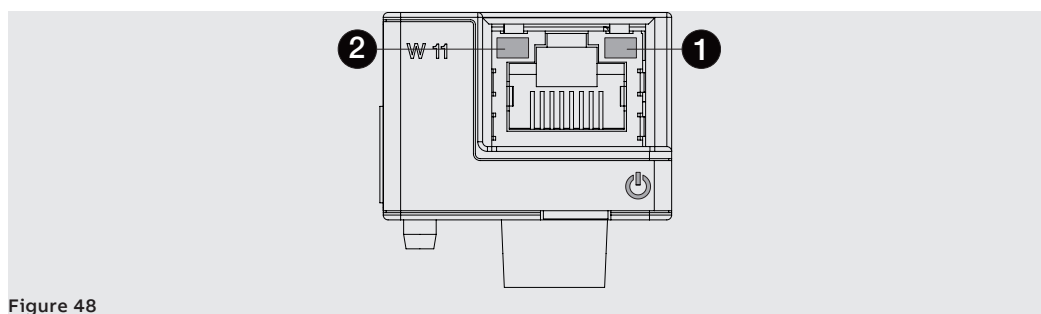

Figure 48

LEDs	Description
Power	Signals the on status and correct communication with Ekip Touch: <ul style="list-style-type: none"> • off: module off • on steady or flashing synchronized with the Power led of Ekip Touch: module on and communication with Trip unit present. • flashing not synchronized with the Power led of Ekip Touch (2 fast flashes per second): module on and communication with Trip unit absent
Link (1)	Indicates the communication state: <ul style="list-style-type: none"> • off: incorrect connection, signal absent. • on steady: connection correct
Activity (2)	Indicates the communication state: <ul style="list-style-type: none"> • off: no activity on line • flashing: activity on line present (receiving and/or transmitting)

Configurations via menu

Local bus activation, which is essential for starting the communication between module and Ekip Touch, is available in the *Settings* menu (page 35).

The following communication parameters can be configured if the module has been correctly detected by Ekip Touch in the *Settings-Modules* menu:

Parameter	Description	Default
<i>Static IP address ON</i>	Defines whether the module has the dynamic (Off) or static (On) IP address. Se = On all the associated parameters are enabled	OFF
<i>Static address IP address</i>	Enables the static IP to be selected	0.0.0.0
<i>Static Network Mask</i>	Enables the subnet mask to be selected	0.0.0.0
<i>Static Gateway address</i>	When there are several subnets, enables the IP address of the node to which the module is connected to be selected	0.0.0.0

Information in menu The following information will be available in the *About-Modules* menu if Ekip Touch has detected the module correctly:

Information	Description
<i>SN and version</i>	Identifier and SW version of the module
<i>IP address</i>	Address of the module, assigned to the module by a DHCP server at the time of connection to the network in the case of configuration with a dynamic IP, or can be set via the menu in the event of a static IP i NOTE: without a DHCP server, the module automatically adopts a random IP address within the 169.254.xxx.xxx range
<i>Network Mask</i>	Subnet mask; identifies the method for recognizing the subnet to which the modules belong and enables modules to be searched for within a defined set of recipients.
<i>Gateway address</i>	IP address of the node to which the module is connected, in the presence of several subnets
<i>MAC address</i>	Address assigned by ABB, with OUI (Organizationally Unique Identifier) equal to ac:d3:64, which uniquely identifies the manufacturer of an Ethernet device

Remote configurations Additional parameters can be accessed via the service connector (via Ekip Connect) or via a system bus communication:

Parameter	Description	Default
<i>Enable IEEE 1588</i>	Allows the IEEE 1588 protocol for distribution of the clock and synchronization signal to be enabled ⁽¹⁾ .	OFF
<i>IEEE 1588 Master</i>	Enables the module to be set up as a master in the the network segment to which it belongs (synchronization clock).	OFF
<i>IEEE 1588 Delay mechanism</i>	Allows the data exchange mode between module and master, either Peer-to-Peer or End-to-End, to be selected.	End-to-End
<i>Enable client SNTP</i>	Allows the SNTP protocol for distribution of the clock and synchronization signal to be enabled ⁽¹⁾	OFF
<i>ANTP Server address</i>	Allows the network server that supplies the SNTP to be set.	0.0.0.0
<i>Time zone</i>	Defines the time zone to be used for synchronism	+00:00
<i>Daylight Saving Time</i>	Used to select whether daylight saving time is present (ON) or not (OFF) in the country to which the synchronization time refers	OFF
<i>IEEE 1588 Boundary clock</i>	Parameter useful if an IEEE 1588 GrandMaster clock is not available: • If enabled (ON), the module is seen as an IEEE1588 master clock by all the slaves/devices in the same local network, even when the source of external synchronism is different from IEEE 1588 (SNTP for example) • If disabled (OFF) the module benefits from the synchronism of the master in its own network	OFF
<i>Enable package Limitation</i>	Enables the Rate limiter function, which limits the number of packages entering the module from the network, to be activated/deactivated	Disable

⁽¹⁾ *Enable IEEE 1588 and Enable SNTP client must not be enabled at the same time*

Remote information Additional information can be accessed via the service connector (via Ekip Connect) or via a system bus communication:

Information	Description
<i>HW and Boot version</i>	General module information
<i>Flash CRC status and result</i>	Information about the correctness of the SW in the module
<i>Ekip Link status</i>	Signals Ethernet cable connection errors
<i>SNTP Server Error</i>	Error in communication with SNTP server
<i>SNTP Server Synchronization</i>	State of synchronism with SNTP server
<i>IEEE 1588 status</i>	Valid with Master IEEE 1588= ON , notifies the presence (Slave or PTP Master Active) or absence (PTP Master but Passive) of a higher level master

10 - Ekip Com IEC 61850

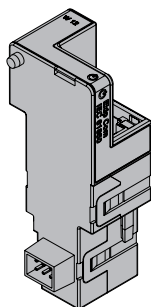

Ekip Com IEC 61850 is a communication accessory which allows Ekip Touch to be integrated into an Ethernet network with IEC 61850 communication protocol, with remote supervision and monitoring functions.

The module is configured as master and remotely, you can:

- read Ekip Touch measurements and information
- manage certain controls, including opening and closing the actuator (MOE-E)
- access information and parameters not available on the display
- transmit vertical communication (report) to superior supervision systems (SCADA), with statuses and measurements (re-transmitted whenever and only if they change with respect to the previous report)
- transmit horizontal communication (GOOSE) to other actuator devices (example: medium voltage circuit-breakers), with all the information about status and measurements normally shared by Ekip Com communication modules via bus.
- If connected to a withdrawable version of the circuit-breaker, the allows the racked-in/racked-out status to be detected



NOTE: *the remote open and close commands of the circuit-breaker can only be executed if Ekip Touch is in the Remote configuration*

The System Interface document is available for mapping the module in its communication network. All the required communication and command details are listed in the document (page 129).

The document also describes the configuration files for the IEC 61850 protocol and relative uploading procedure for assigning the Technical Name and enabling GOOSE messages if required (by setting the relative MAC Addresses)

Depending on the parameter settings, described in the next pages, the ports used by the module are:

Ethertype	Port	Protocol
0x0800-IP	102	ISO Transport Service on top of the TCP (RFC 1006)
0x88B8	-	GOOSE Messages
0x0800-IP	123 UDP	NTP - Network Time Protocol
0x0800-IP	69 UDP	TFTP - Trivial File Transfer Protocol

Accessories *Ekip Cartridge* and *Ekip Supply* are required in order to connect *Ekip Com EtherNet/IP™* to Ekip Touch (page 130, 131).

Safety and cyber security

The module uses the HTTPS protocol and can be connected to the Internet

Since the module allows the actuator connected to Ekip Touch and access to the data in the unit to be checked, it can only be connected to networks equipped with all the necessary security and prevention measures against unauthorized access (for example, the network of the control system of an installation).



IMPORTANT:

- **it is the customer's sole responsibility to provide and continuously ensure a secure connection between the module and customer network or any other network (as the case may be). The plant manager must establish and maintain appropriate measures (such as but not limited to the installation of firewalls, application of authentication measures, encryption of data, installation of antivirus programs, etc.) to protect the product, the network, the customer system and interface against any kind of security breaches, unauthorized access, interference, intrusion, loss and/or theft of data or information. ABB and its affiliates are not liable for damages and/or losses related to such security breaches, unauthorized accesses, interference, intrusion, loss and/or theft of data or information.**
- **The module cannot be connected directly to the Internet. Only connect to dedicated Ethernet networks with IEC 61850 communication protocol**

Models Two different modules compatible with the IEC 61850 protocol are available: *Ekip Com IEC 61850* and *Ekip Com IEC 61850 Redundant*.

The modules are identical in terms of characteristics and installation methods, except for: display menus, cabling and addresses for system communication, which are specific for each module.

NOTE: if different indications are not given, the information in the next chapter is valid for both models

The two modules can be connected at the same time to Ekip Touch so as to expand the potential of the unit (e.g. for applications where high grid reliability is required).

IMPORTANT: each Ekip Touch can be fitted with only one module per type. The configuration with two modules of the same model is not allowed (example: two Ekip Com IEC 61850 Redundant)

Connections

For references about the connection and terminals, please consult document [1SDM000005A1001](#); a cable of the Class 6 S/FTP type (Class 6 with double screening S/FTP) must be used for the communication bus.

To connect the module to *Ekip Supply* and *Ekip Cartridge*, please consult document [1SDH002009A1503](#).

Power supply *Ekip Com IEC 61850* is supplied directly by the *Ekip Supply* module to which it is connected..

NOTE: communication between Ekip Touch and the module is interrupted in the absence of auxiliary power supply

Interface the module has three signaling leds:

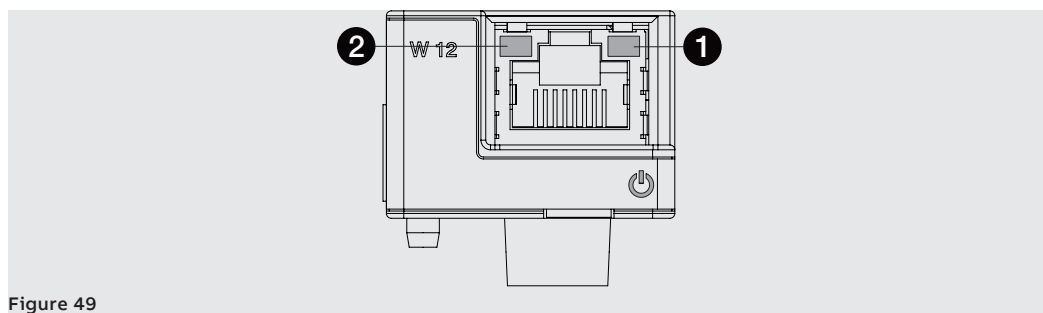

Figure 49

LEDs	Description
Power	Signals the on status and correct communication with Ekip Touch: <ul style="list-style-type: none"> • off: module off • on steady or flashing synchronized with the Power led of Ekip Touch: module on and communication with Trip unit present. • flashing not synchronized with the Power led of Ekip Touch (2 fast flashes per second): module on and communication with Trip unit absent
Link (1)	Indicates the communication state: <ul style="list-style-type: none"> • off: incorrect connection, signal absent. • on steady: connection correct
Activity (2)	Indicates the communication state: <ul style="list-style-type: none"> • off: no activity on line • flashing: activity on line present (receiving and/or transmitting)

Configurations via menu Local bus activation, which is essential for starting the communication between module and Ekip Touch, is available in the *Settings* menu (page 35).

The following communication parameters can be configured if the module has been correctly detected by Ekip Touch in the *Settings-Modules* menu:

Parameter	Description	Default
<i>Static IP address ON</i>	Defines whether the module has the dynamic (Off) or static (On) IP address. Se = On all the associated parameters are enabled	OFF
<i>Static address IP address</i>	Enables the static IP to be selected	0.0.0.0
<i>Static Network Mask</i>	Enables the subnet mask to be selected	0.0.0.0
<i>Static Gateway address</i>	When there are several subnets, enables the IP address of the node to which the module is connected to be selected	0.0.0.0
<i>Enable SNTP client</i>	Allows the SNTP protocol for distribution of the clock and synchronization signal to be enabled.	OFF
<i>SNTP Server Addr.</i>	Allows the network server that supplies the SNTP to be set.	0.0.0.0
<i>Configuration Session</i>	Defines the write mode of the configuration file in the module via the TFTP port; two options are available: <ul style="list-style-type: none"> • Always ON: the TFTP port is always open and write is always enabled • Activation requested: the TFTP is opened by a specific command, which enables write for a limited time (or for a finite number of data packages) 	Always ON
<i>Start Configuration</i>	Write enable command on TFTP port in Activation mode requested	---

Information in menu The following information will be available in the *About-Modules* menu if Ekip Touch has detected the module correctly:

Information	Description
<i>SN and version</i>	Identifier and SW version of the module
<i>IP address</i>	Address of the module, assigned to the module by a DHCP server at the time of connection to the network in the case of configuration with a dynamic IP, or can be set via the menu in the event of a static IP  NOTE: <i>without a DHCP server, the module automatically adopts a random IP address within the 169.254.xxx.xxx range</i>
<i>Network Mask</i>	Subnet mask; identifies the method for recognizing the subnet to which the modules belong and enables modules to be searched for within a defined set of recipients.
<i>Gateway address</i>	IP address of the node to which the module is connected, in the presence of several subnets
<i>MAC address</i>	Address assigned by ABB, with OUI (Organizationally Unique Identifier) equal to ac:d3:64, which uniquely identifies the manufacturer of an Ethernet device
<i>Cfg file</i>	Name of the configuration file uploaded to the modules
<i>Cfg file error</i>	Code of the error concerning the configuration file (0 = no error)

Remote configurations

Additional parameters can be accessed via the service connector (via Ekip Connect) or via a system bus communication:

Parameter	Description	Default
<i>Preferred configuration file</i>	If several configuration files are present, allows file hierarchy between .cid and .iid to be defined	.cid
<i>Enable IEEE 1588</i>	Allows the IEEE 1588 protocol for distribution of the clock and synchronization signal to be enabled ⁽⁴⁾ .	OFF
<i>IEEE 1588 Master</i>	Enables the module to be set up as a master in the the network segment to which it belongs (synchronization clock).	OFF
<i>IEEE 1588 Delay mechanism</i>	Allows the data exchange mode between module and master, either Peer-to-Peer or End-to-End, to be selected.	End-to-End
<i>Time zone</i>	Defines the time zone to be used for synchronism	+00:00
<i>Daylight Saving Time</i>	Used to select whether daylight saving time is present (ON) or not (OFF) in the country to which the synchronization time refers	OFF
<i>TFTP Security level</i>	Defines the file loading procedure: <ul style="list-style-type: none"> • <i>TFTP always On</i> = port open, loading always possible • <i>TFTP enable required</i> = port normally closed. To start loading, <i>Enable TFTP</i> must be run at the start of the procedure and <i>Disable TFTP</i> must be run at the end of the procedure (disable not necessary, security command). 	TFTP always On
<i>CB Open/CB Close command</i>	Defines the limitations to remote opening and closing command execution: <ul style="list-style-type: none"> • <i>Standard commands</i> = standard commands (unrestricted) activated • <i>CB operate request</i> = standard commands not activated. Use programmable functions YC COMMAND and YO COMMAND, and Request breaker open (28) and Request breaker close (29) commands 	Standard commands
<i>Zone Selectivity Analysis</i>	Analysis of selectivity input from IEC 61850 module can be enabled/disabled for each of protections S, S2, G, Gext, D, D(BW), D(FW)	Disabled (all)
<i>IEEE 1588 Boundary clock</i>	Parameter useful if an IEEE 1588 GrandMaster clock is not available: <ul style="list-style-type: none"> • If enabled (ON), the module is seen as an IEEE1588 master clock by all the slaves/devices in the same local network, even when the source of external synchronism is different from IEEE 1588 (SNTP for example) • If disabled (OFF) the module benefits from the synchronism of the master in its own network 	OFF
<i>Enable package Limitation</i>	Enables the Rate limiter function, which limits the number of packages entering the module from the network, to be activated/deactivated	Disable

⁽⁴⁾ *Enable IEEE 1588 and Enable SNTP client must not be enabled at the same time*

Remote information

Additional information can be accessed via the service connector (via Ekip Connect) or via a system bus communication:

Information	Description
<i>HW and Boot version</i>	General module information
<i>Flash CRC status and result</i>	Information about the correctness of the SW in the module
<i>Ekip Link status</i>	Signals Ethernet cable connection errors
<i>SNTP Server Error</i>	Error in communication with SNTP server
<i>SNTP Server Synchronization</i>	State of synchronism with SNTP server
<i>IEEE 1588 status</i>	Valid with Master IEEE 1588= ON , notifies the presence (Slave or PTP Master Active) or absence (PTP Master but Passive) of a higher level master
<i>GOOSE Missing</i>	Signals that an expected GOOSE has not been received
<i>Configure Mismatch</i>	A GOOSE received does not conform to the expected structure
<i>Decode Error</i>	
<i>Sequence number error</i>	
<i>Remote programmable statuses (from E to R)</i>	Condition (true/false) of the programmable states and information on selectivity arising from logic defined in the configuration files loaded in module IEC 61850
<i>Zone selectivity remote inputs</i>	

11 - Ekip Link

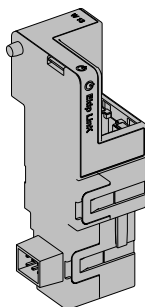

Ekip Link is a communication accessory which allows Ekip Touch to be integrated into an internal Ethernet network with ABB proprietary protocol.

The following functions can be performed with the remote module:

- Programmable Logic
- Zone Selectivity

To perform these functions, the system units involved must be equipped with their own *Ekip Link* and for each of these, the IP addresses of all the other *Ekip Link* connected must have been entered.

Each device is defined as an Actor in the Link network.

Each *Ekip Link* can interface with up to 15 actors, of which up to 12 for the *Zone Selectivity* function.

The ports used by the module are:

Port	Service	Notes
18/udp	ABB proprietary	In the case of rapid exchanges of information among ABB devices
319/udp	IEEE 1588	Valid with IEEE 1588 protocol enabled
320/udp		
68/udp	DHCP client	DHCP client enabled alternatively as <i>Static address = On</i>

Accessories *Ekip Cartridge* and *Ekip Supply* are required in order to connect *Ekip Link* to Ekip Touch (page 130, 131).

If connected to a withdrawable version of the circuit-breaker, it is possible to detect the racked-in/racked-out status

Network The *Ekip Link* modules must be connected to a dedicated network that includes only *Ekip Link* and Ethernet switches for which support for level L2 multicast is declared in the datasheet.

If the network also includes routers, multicast must be enabled and configured in all the level L3 VLAN interfaces.

Programmable Logic Activation of up to four bits of the *Ekip Link* can be programmed via the Programmable Logic function, each bit according to any combination of the status bits of an actor of which the IP address has been entered.

These four bits are indicated as Statuses A B C and D; they are remotely programmable and their value is transmitted to the device to which *Ekip Link* is connected

Zone selectivity With the Zone Selectivity function:

- the IP addresses entered refer to actors with the role of interlock with respect to the current role
- the protections for which selectivity must be actuated by setting a mask, must be selected for each interlock actor entered. Thus set, the function will now be indicated as logic in the following text so as to distinguish it from the standard function, now also indicated as hardware in the following text
- thus selected, the protections add to those of the hardware S, I, 2I, MCR, G, D-Backward and D-Forward
- hardware selectivity only, or both hardware and logic selectivity can be selected
- diagnosis can be set, for each interlock release, to ascertain whether there is consistency between the hardware and logic selectivity information
- a mask can be set for the purpose of identifying those protections whose received selectivity information must be re-transmitted, regardless of whether the actor is in the alarm status. The mask is only applicable to logic selectivity information

For further details about the *Zone Selectivity* function with *Ekip Link*, please consult page 79.

Connections For references about the connection and terminals, please consult document [1SDM000005A1001](#); a cable of the Class 6 S/FTP type (Class 6 with double screening S/FTP) must be used for the communication bus.

To connect the module to *Ekip Supply* and *Ekip Cartridge*, please consult document [1SDH002009A1503](#).

Power supply *Ekip Link* is supplied directly by the *Ekip Supply* module to which it is connected.



NOTE: communication between *Ekip Touch* and the module is interrupted in the absence of auxiliary power supply

Interface the module has three signaling leds:

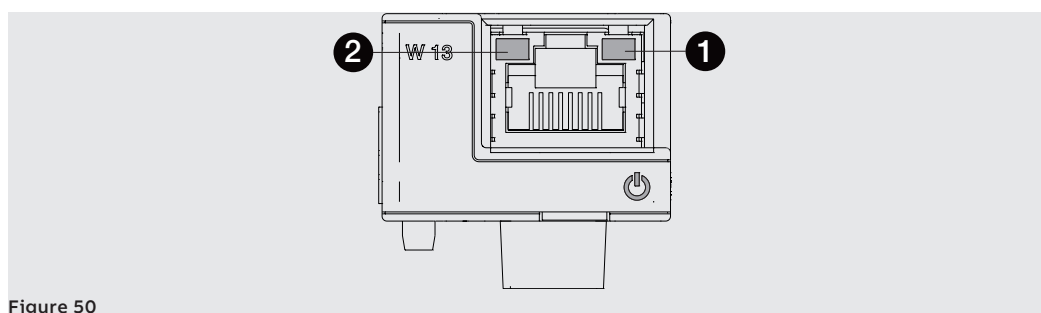

Figure 50

LEDs	Description
Power	Signals the on status and correct communication with <i>Ekip Touch</i> : <ul style="list-style-type: none"> • off: module off • on steady or flashing synchronized with the Power led of <i>Ekip Touch</i>: module on and communication with Trip unit present. • flashing not synchronized with the Power led of <i>Ekip Touch</i> (2 fast flashes per second): module on and communication with Trip unit absent
Link (1)	Indicates the communication state: <ul style="list-style-type: none"> • off: incorrect connection, signal absent. • on steady: connection correct
Activity (2)	Indicates the communication state: <ul style="list-style-type: none"> • off: no activity on line • flashing: activity on line present (receiving and/or transmitting)

Configurations via menu Local bus activation, which is essential for starting the communication between module and Ekip Touch, is available in the *Settings* menu (page 35).

The following communication parameters can be configured if the module has been correctly detected by Ekip Touch in the *Settings-Modules* menu:

Parameter	Description	Default
<i>Static IP address ON</i>	Defines whether the module has the dynamic (Off) or static (On) IP address. Se = On all the associated parameters are enabled	OFF
<i>Static address IP address</i>	Enables the static IP to be selected	0.0.0.0
<i>Static Network Mask</i>	Enables the subnet mask to be selected	0.0.0.0
<i>Static Gateway address</i>	When there are several subnets, enables the IP address of the node to which the module is connected to be selected	0.0.0.0

Information in menu The following information will be available in the *About-Modules* menu if Ekip Touch has detected the module correctly:

Information	Description
<i>SN and version</i>	Identifier and SW version of the module
<i>IP address</i>	Address of the module, assigned to the module by a DHCP server at the time of connection to the network in the case of configuration with a dynamic IP, or can be set via the menu in the event of a static IP  NOTE: <i>without a DHCP server, the module automatically adopts a random IP address within the 169.254.xxx.xxx range</i>
<i>Network Mask</i>	Subnet mask; identifies the method for recognizing the subnet to which the modules belong and enables modules to be searched for within a defined set of recipients.
<i>Gateway address</i>	IP address of the node to which the module is connected, in the presence of several subnets
<i>MAC address</i>	Address assigned by ABB, with OUI (Organizationally Unique Identifier) equal to ac:d3:64, which uniquely identifies the manufacturer of an Ethernet device

Remote configurations Additional parameters can be accessed via the service connector (via Ekip Connect) or via a system bus communication:

Parameter	Description	Default
<i>Client/Server</i>	Parameter for changing the configuration of the module from Server Only to Client and Server and for integrating it into an interactive data exchange network (see Ekip Com Hub on page 159).  IMPORTANT: if Client/Server, the module allows data exchange like a normal Server function	Server only
<i>Enable IEEE 1588</i>	Allows the IEEE 1588 protocol for distribution of the clock and synchronization signal to be enabled ⁽¹⁾ .	OFF
<i>IEEE 1588 Master</i>	Enables the module to be set up as a master in the the network segment to which it belongs (synchronization clock).	OFF
<i>IEEE 1588 Delay mechanism</i>	Allows the data exchange mode between module and master, either Peer-to-Peer or End-to-End, to be selected.	End-to-End
<i>Enable client SNTP</i>	Allows the SNTP protocol for distribution of the clock and synchronization signal to be enabled ⁽¹⁾	Off
<i>ANTP Server address</i>	Allows the network server that supplies the SNTP to be set.	0.0.0.0
<i>Time zone</i>	Defines the time zone to be used for synchronism	+00:00
<i>Daylight Saving Time</i>	Used to select whether daylight saving time is present (ON) or not (OFF) in the country to which the synchronization time refers	OFF

Continued on the next page

Parameter	Description	Default
<i>Disable Gratuitous ARP</i>	Permits (Enabled ARP) the periodic generation of a Gratuitous ARP message, used by Ekip Connect to rapidly find the modules via Ethernet scan without knowing the IP address beforehand	ARP Enabled
<i>Password protected access</i>	Enables the writing operations performed via the network to be protected by a password (Request password)	Standard mode
<i>Password Modbus TCP</i>	With access protected by enabled password, this is the password to use before each writing session ⁽²⁾ .	Local access

⁽¹⁾ Enable IEEE 1588 and Enable SNTP client must not be enabled at the same time

⁽²⁾ the parameter can only be changed via system bus in the remote configuration

Remote Link configurations

Regarding the Link functions, the following further parameters are available:

Parameter	Description	Default
<i>Link Actor (1÷15)</i>	IP address of each actor (from 1 to 15)	0.0.0.0
<i>Remote Programmable Status (A÷D)</i>	Configuration parameters of the configurable states: <ul style="list-style-type: none"> • selection of actor (actor from 1 to 15) which activates the programmable status • event of the actor that determines change of programmable status 	Actor 1 None
<i>Remote Status word (A÷D)</i>	Configuration parameters of the words: <ul style="list-style-type: none"> • selection of actor (actor from 1 to 15) from which the word status is taken • selection of the taken word 	None 1 global
<i>Diagnostic</i>	Active (Passive diagnosis) or deactivated (No diagnosis) cabled selectivity diagnosis	No Diagnostic
<i>Diagnostic check timeout</i>	30 s, 1 min, 10 min, 60 min diagnosis frequency intervals available, if activated	30 seconds
<i>Zone Selectivity Type</i>	Configuration of hardware selectivity (Only HW) or hardware and logic (Mixed)	HW only
<i>Repeat Configuration mask</i>	Interactive mask for selecting selectivity to be sent also to the upper levels (even if not active in the programmed device)	0x0000

Remote information

Additional information can be accessed via the service connector (via Ekip Connect) or via a system bus communication:

Information	Description
<i>HW and Boot version</i>	General module information
<i>Flash CRC status and result</i>	Information about the correctness of the SW in the module
<i>Ekip Link status</i>	Signals Ethernet cable connection errors
<i>SNTP Server Error</i>	Error in communication with SNTP server
<i>SNTP Server Synchronization</i>	State of synchronism with SNTP server
<i>IEEE 1588 status</i>	Valid with Master IEEE 1588= ON , notifies the presence (Slave or PTP Master Active) or absence (PTP Master but Passive) of a higher level master

Remote Link information

Regarding the Link functions, the following further parameters are available:

Information	Description
<i>Line Congruency detection</i>	Information about the state and inconsistency of HW and logic selectivity (state and type of selectivity inconsistent)
<i>Remote Programmable Status</i>	Status (true/false) of remote programmable statuses A, B, C and D
<i>Remote Status Word</i>	Value of remote programmable Words A, B, C, D
<i>Logic Zone Selectivity</i>	Logic selectivity states (inputs and outputs)

12 - Ekip Com Hub

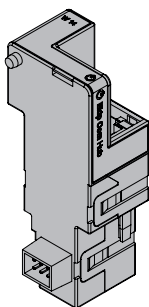

Ekip Com Hub is a communication accessory that enables the data and measurements of Ekip Touch and other devices connected to the same installation to be gathered and then made available on the server through an Ethernet network.

The configuration of the module is available via Ekip Connect or with the System Interface document, which contains all the details. (page 129).

The ports used by the module are:

Port	Service	Notes
67/udp 68/udp	DHCP client	DHCP client enabled alternatively as <i>Static address = On</i>
443/tcp	HTTPS	Always active when module is enabled
123/udp	SNTP	Active with SNTP client enabled
53/udp	DNS	Always active

The *Ekip Com Modbus RTU* and *Ekip Com Modbus TCP* modules can be configured to support *Ekip Com Hub* in the collection of data to send to Cloud. See Getting Started [1SDC200063B0201](#).

Accessories *Ekip Cartridge* and *Ekip Supply* are required in order to connect *Ekip Com Hub* to Ekip Touch (page 130, 131).

If connected to a withdrawable version of the circuit-breaker, it is possible to detect the racked-in/racked-out status

Safety and cyber security The module uses the HTTPS protocol and can be connected to the Internet



IMPORTANT:

- **it is the customer's sole responsibility to provide and continuously ensure a secure connection between the module and customer network or any other network (as the case may be). The plant manager must establish and maintain appropriate measures (such as but not limited to the installation of firewalls, application of authentication measures, encryption of data, installation of antivirus programs, etc.) to protect the product, the network, the customer system and interface against any kind of security breaches, unauthorized access, interference, intrusion, loss and/or theft of data or information. ABB and its affiliates are not liable for damages and/or losses related to such security breaches, unauthorized accesses, interference, intrusion, loss and/or theft of data or information.**

Connections For references about the connection and terminals, please consult document [1SDM000005A1001](#); a cable of the Class 6 S/FTP type (Class 6 with double screening S/FTP) must be used for the communication bus.

To connect the module to *Ekip Supply* and *Ekip Cartridge*, please consult document [1SDH002009A1503](#).

Power supply *Ekip Com Hub* is supplied directly by the Ekip Supply module to which it is connected.



NOTE: communication between Ekip Touch and the module is interrupted in the absence of auxiliary power supply

Interface the module has three signaling leds:

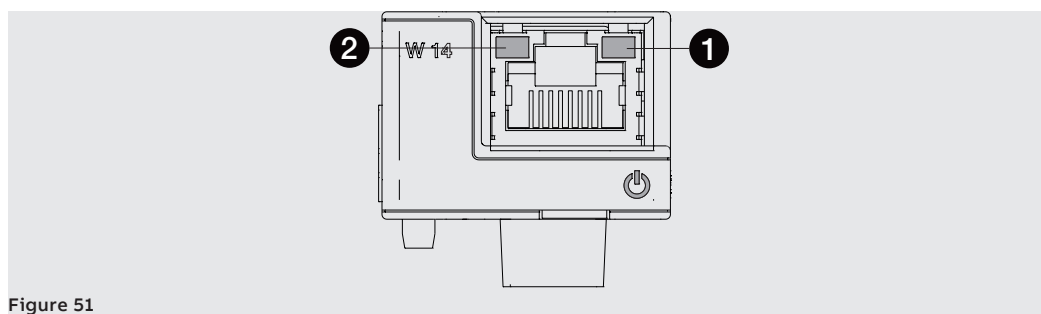

Figure 51

LEDs	Description
Power	Signals the on status and correct communication with Ekip Touch: <ul style="list-style-type: none"> • off: module off • on steady or flashing synchronized with the Power led of Ekip Touch: module on and communication with Trip unit present. • flashing not synchronized with the Power led of Ekip Touch (2 fast flashes per second): module on and communication with Trip unit absent
Link (1)	Indicates the communication state: <ul style="list-style-type: none"> • off: incorrect connection, signal absent. • on steady: connection correct
Activity (2)	Indicates the communication state: <ul style="list-style-type: none"> • off: no activity on line • flashing: activity on line present (receiving and/or transmitting)

Configurations via menu Local bus activation, which is essential for starting the communication between module and Ekip Touch, is available in the *Settings* menu (page 35).

The following communication parameters can be configured if the module has been correctly detected by Ekip Touch in the *Settings-Modules* menu:

Parameter	Description	Default
<i>Enable</i>	Switches communication between module and server on/off.	Off
<i>Static IP address ON</i>	Defines whether the module has the dynamic (Off) or static (On) IP address. If = On all the associated parameters are enabled	Off
<i>Static address IP address</i>	Enables the static IP to be selected	0.0.0.0
<i>Static Network Mask</i>	Enables the subnet mask to be selected	0.0.0.0
<i>Static Gateway address</i>	When there are several subnets, enables the IP address of the node to which the module is connected to be selected	0.0.0.0
<i>Enable SNTP client</i>	Allows the SNTP protocol for distribution of the clock and synchronization signal to be enabled.	Off
<i>SNTP Server Addr.</i>	Allows the network server that supplies the SNTP to be set.	0.0.0.0
<i>Password</i>	Code required to register module on Cloud	---

The Remote FW update submenu enables the Firmware update function of the module to be managed; the following parameters are available:

Parameter	Description	Default
<i>Enable</i>	Enables firmware update function of module to be remotely activated/deactivated	OFF
<i>Automatic</i>	The parameter is available when Enable = On and allows the automatic update mode to be activated (On): in the presence of new Firmware, this latter is updated automatically. If the parameter is Off, updating must be performed in the Manual mode: in the presence of new Firmware, the message Ekip Com Hub FW Update appears in the status bar and updating is performed via the Manual command.	OFF (manual)
<i>Start FW update</i>	This parameter is available when Enable= On, with Automatic= Off configuration and when new Firmware is present (see description above); allows the Firmware update of the module to run	

Information in menu

The following information will be available in the *About-Modules* menu if Ekip Touch has detected the module correctly:

Information	Description
<i>SN and version</i>	Identifier and SW version of the module
<i>IP address</i>	Address of the module, assigned to the module by a DHCP server at the time of connection to the network in the case of configuration with a dynamic IP, or can be set via the menu in the event of a static IP  NOTE: without a DHCP server, the module automatically adopts a random IP address within the 169.254.xxx.xxx range
<i>Network Mask</i>	Subnet mask; identifies the method for recognizing the subnet to which the modules belong and enables modules to be searched for within a defined set of recipients.
<i>Gateway address</i>	IP address of the node to which the module is connected, in the presence of several subnets
<i>MAC address</i>	Address assigned by ABB, with OUI (Organizationally Unique Identifier) equal to ac:d3:64, which uniquely identifies the manufacturer of an Ethernet device

Remote configurations

Additional parameters can be accessed via the service connector (via Ekip Connect) or via a system bus communication:

Parameter	Description	Default
<i>CRL Enable</i>	Allows the CRL (Certificate Revocation List) to be used to ascertain whether the server certificate is valid	
<i>Clock update hardening enable</i>	Enables control of the time reference transmitted by the SNTP server	
<i>SNTP Server Location</i>	Enables the position of the SNTP server to be set in relation to the network in which the module is installed	
<i>SNTP Time zone</i>	Defines the time zone to be used for synchronism	+00:00
<i>SNTP Daylight Saving Time</i>	Used to select whether daylight saving time is present (ON) or not (OFF) in the country to which the synchronization time refers	OFF
<i>Disable Gratuitous ARP</i>	Permits (Enabled ARP) the periodic generation of a Gratuitous ARP message, used by Ekip Connect to rapidly find the modules via Ethernet scan without knowing the IP address beforehand	ARP Enabled
<i>Cloud data send enable</i>	Enables/disables the function that collects and transmits the module data	OFF
<i>JSON data compression</i>	Allows the compressed format of the JSON file sent to Cloud to be selected (enable)	Disabled

Remote information Additional information can be accessed via the service connector (via Ekip Connect) or via a system bus communication:

Information	Description
<i>HW and Boot version</i>	General module information
<i>Flash CRC status and result</i>	Information about the correctness of the SW in the module
<i>Publish enable configuration</i>	State of enabling in Security File
<i>Configuration file</i>	Name of the file dedicated to the information to transmit (measurements, etc.)
<i>Security file</i>	Name of the file dedicated to the information requested by the module for transmission purposes (addresses, certificates, etc.)
<i>Certificate Revocation List</i>	Name of the file containing the revoked certificates
<i>Executable file</i>	Name of the executable firmware update file
<i>Configuration error</i>	Module configuration error state
<i>Sample time</i>	Period of data acquisition from the connected devices
<i>Log time</i>	Period within which the acquired data are saved in the log
<i>Upload time</i>	Period (calculated by the module) between each data transmission
<i>Configured device</i>	Number of modules involved in the network with Hub module
<i>Polling period API events</i>	Period in which the module communicates with the API device
<i>Connection client 1, 2, 3</i>	Address of TCP Modbus clients connected to the module
<i>Statistics</i>	Recordings of the latest saving operations and percentage of resources being used
<i>Status plant side</i>	Information about the quality of the communication with the other devices
<i>Status Cloud side</i>	State of the errors concerning the TLS session established between module and server
<i>Application status</i>	Operation progress indicators
<i>Status</i>	General indicators of the module: SNTP state, flash, cable connection, FW availability, file errors, etc.

13 - Ekip Signalling 2K

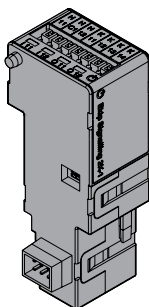

Ekip Signalling 2K is an accessory signaling module allowing programmable inputs/outputs to be managed.

This module has:

- two contacts for output signals and relative status led
- two digital inputs and relative status led
- a Power led with the startup status of the module

Accessories *Ekip Cartridge* and *Ekip Supply* are required in order to connect *Ekip Signalling 2K* to *Ekip Touch* (page 130, 131).

Models Three different Signalling 2K modules are available: *Ekip Signalling 2K-1*, *Ekip Signalling 2K-2* and *RELT - Ekip Signalling 2K-3*.

The modules are identical in terms of characteristics and installation methods, except for: display menus, cabling and addresses for system communication, which are specific for each module.



NOTE: if different indications are not given, the information in the next chapter is valid for all three models

The three modules can be connected at the same time to *Ekip Touch* so as to expand the potential of the unit (e.g. to increase the number of control outputs and inputs).

Two of the three modules can be connected at the same time to *Ekip Touch* so as to expand the potential of the unit (e.g. to increase the number of control outputs and inputs).



IMPORTANT: each *Ekip Touch* can be fitted with only one module per type. The configuration with two or three modules of the same model is not allowed (example: two *Ekip Signalling 2K-1* modules)

RELT - Ekip Signalling 2K-3

The *RELT - Ekip Signalling 2k-3* module has a dedicated command (*RELT Wizard*) for auto-programming a set of trip unit parameters; The wizard ensures the activation of the 2I protection when the input of the *RELT - Ekip Signalling 2k-3* module active. In addition, the 2I is placed in local model and the *RELT* module's outputs are activated.

Below is a complete list of the parameters configured by the command:

Parameter	Configuration from RELT Wizard command	Page
2I Protection ⁽¹⁾	On; Threshold I31 = 1,5 In	48
2I Protection Function	Delay ON=100 ms; Delay OFF=15s; Activation = dependent function; Function = RELT - Ekip Signalling 2K-3 Input 1 (I31)	48, 78
Input I31 (RELT - Ekip Signalling 2K-3)	Polarity = active closed; Delay = 0,1 s	164, 165
Output O31 and O32 (RELT - Ekip Signalling 2K-3)	Signal source = 2I protection active; Delay = 0 s; Contact type = NO; Self-latching = OFF; min Activation Time = 0 ms	166
SwitchOnLocal Function	Function = 2I protection active; Delay = 0 s	78

⁽¹⁾ if *Dual set* is present, programming performed for both *Set A* and *Set B*

The *RELT* setup Wizard can be found in the 2I protection menu and also the first time the trip unit is switched ON.

In the case that the wizard is not executed (or is rejected during the initial trip unit start up), the functionality and the characteristic of the *RELT - Ekip Signalling 2k-3* module will be as described in the following pages.

Connections For references about the connection and terminals, please consult document [1SDM000005A1001](#) and [1SDM000019A1002](#); use AWG 22-16 cables with 1.4 mm maximum outer diameter for the external cabling. To connect the module to *Ekip Supply* and *Ekip Cartridge*, please consult document [1SDH002009A1503](#).

Power supply *Ekip Com Signalling 2K* is supplied directly by the *Ekip Supply* module to which it is connected.



NOTE: communication between *Ekip Touch* and the module is interrupted in the absence of auxiliary power supply

Input *Ekip Touch* can be configured so that the status of the inputs corresponds to actions or signals, with different programming options (page 165).

The connection of each input (H11 and H12 for model 2K-1, H21 and H22 for model 2K-2, H31 and H32 for model 2K-3) must be made with reference to the common contacts (HC).

The module permits two logic statuses, interpreted differently by *Ekip Touch* depending on the configuration selected for each contact:

State	Electrical condition	Contact configuration	Status detected by Trip unit
Open	Circuit open ⁽¹⁾	Active open	ON
		Active closed	OFF
Closed	Short-circuit ⁽²⁾	Active open	OFF
		Active closed	ON

⁽¹⁾ $R > 100 \text{ k}\Omega$

⁽²⁾ $R (\text{wiring} + \text{short circuit contact}) < 25 \Omega$

Output *Ekip Touch* can be configured so that the contacts of each output are closed or opened upon the occurrence of one or more events, with different programming options (page 165).

The output of each module consists of 2 contacts (K11-K12 and K13-K14 for model 2K-1; K21-K22 and K23-K24 for model 2K-2; K31-K32 and K33-K34 for model 2K-3), which are isolated from the unit and from the other outputs, and have the following electrical characteristics:

Characteristics	Maximum limit ⁽¹⁾
Maximum switchable voltage	150 VDC / 250 VAC
Breaking capacity	2 A @ 30 VDC, 0,8 A @ 50 VDC, 0,2 A @ 150 VDC, 4 A @ 250 VAC
Dielectric strength between open contacts	1000 V AC (1 minute @ 50 Hz).
Dielectric strength between each contact and coil	1000 V AC (1 minute @ 50 Hz).

⁽¹⁾ data relating to a resistive load

Interface the module has three signaling leds:

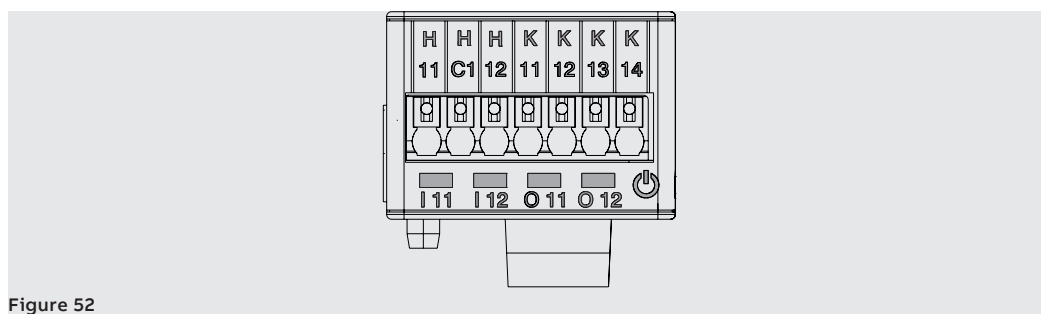

Figure 52

LEDs	Description
Power	Signals the on status and correct communication with Ekip Touch: <ul style="list-style-type: none"> • off: module off • on steady or flashing synchronized with the Power led of Ekip Touch: module on and communication with Trip unit present. • flashing not synchronized with the Power led of Ekip Touch (2 fast flashes per second): module on and communication with Trip unit absent
I 11, I 12	Indicate the status of the contacts of each output: <ul style="list-style-type: none"> • off: contact open • on: contact closed
O 11, O 12	Indicate the status of the contacts of each input: <ul style="list-style-type: none"> • off: circuit open • on: short circuit

Menu The specific configuration area will activate in the *Settings - Modules* menu if the *Ekip Signalling 2K* module is detected correctly by Ekip Touch.

A specific menu containing the submenus of all the available and configurable inputs and outputs is available for each *Ekip Signalling 2K* module detected by Ekip Touch.

Input parameters All the available inputs enable the following parameters to be configured:

Parameter	Description	Default
<i>Polarity</i>	Defines whether the input is interpreted as ON by Ekip Touch when it is open (<i>Active open</i>) or when it is closed (<i>Active Closed</i>)	Active closed
<i>Delay</i>	Minimum activation time of the input before status change is recognized; the delay is given in seconds and can be set within range: 0 s to 100 s, in 0.01 s steps i NOTES: <ul style="list-style-type: none"> • if the input is deactivated before this time has elapsed the status change is not recognized • if delay = 0 s status change must still be more than 300 μS 	0.1 s

Output parameters All the available inputs enable the following parameters to be configured:

Parameter	Description	Default
<i>Signal source</i>	Event which activates the output and switches the contacts. Different protection proposals, statuses and thresholds are available on the display; the Custom mode can be configured via Ekip Connect so as to extend the solutions and combine several events	None
<i>Delay</i>	Minimum duration of the presence of the source before the output is activated; the delay is given in seconds and can be set within range: 0 s to 100 s, in 0.01 s steps  NOTES: • the output will not be switched if the source is deactivated before this time has elapsed • if delay = 0 s the source must still be present for longer than 300 µS	0 s
<i>Contact Type</i>	Defines the rest status of the contact with source not present between: open (NO) and closed (NC)	NO
<i>Latched</i>	Allows the output (and relative status led) to be kept activated (On) or deactivated (Off) when the event disappears	OFF
<i>min Activation Time</i>	Defines the minimum closing time of the contact following the rapid presence of sources: • Source duration < min. activation = contact is activated for the minimum activation time • Source duration ≥ min. activation = contact is activated for as long as the source persists Choose between: 0 ms, 100 ms, 200 ms	0 ms

About The specific menu of the module available in the *About - Modules* menu contains:

- the serial number and version of the module
- the statuses of the inputs (On/Off) and outputs (Open/Closed)

Test The test area in the *Test* menu is activated if the *Ekip Signalling 2K* module is detected correctly. For details of the test characteristics, please consult page 125.

Remote information Certain additional information concerning the version and status of the module is available via the service connector (via Ekip Connect) or by communication via system bus; the information includes: HW and Boot version, CRC status (correctness of the SW in the module).

14 - Ekip Synchrocheck

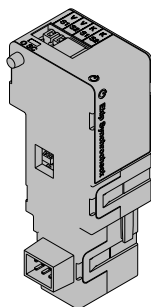

Ekip Synchrocheck is an accessory module that is used to control closing of an actuator when synchronism conditions, programmable by the user, exist.

To actuate synchronism:

- *Ekip Synchrocheck* and the internal sockets measure, respectively, the voltage on the external contacts (external voltage) and on the internal contacts (internal voltage) of the actuator
- *Ekip Synchrocheck* manages a closing contact



NOTES:

- *the actuator is described as a circuit-breaker in the following description and in the menus*
- *with a generator and the actuator being configured: Normally, the external voltage is that of the grid and the internal voltage is that of the generator*



IMPORTANT: only one Ekip Synchrocheck can be installed on each CB

Accessories *Ekip Cartridge* and *Ekip Supply* are required in order to connect *Ekip Synchrocheck* to Ekip Touch (page 130, 131).

Mode The module operates in two modes, configurable by the user (manual-mode configuration) or managed automatically by the unit (automatic-mode configuration).

Conditions	Description
Busbar active	Operation with external voltage other than zero: <ul style="list-style-type: none"> • synchronism search starts if the external voltage is (0.5 U_n by default) or more, for at least (1 s by default) • synchronism is considered to have been reached if the differences between RMS values and frequencies and the voltage phases are (0.12 U_n, 0.1 Hz, and 50° by default) or less
Dead busbar and configuration: <i>Normal</i>	Operation with one of the voltages nil: <ul style="list-style-type: none"> • synchronism search starts if the internal voltage is (0.5 U_n by default) or more, for at least (1 s by default) • synchronism is considered to have been reached if the external voltage is (0.2 U_n by default) or less, for at least (1 s by default)



NOTE: *with dead busbar and configuration: Reversed, the roles of the internal and external voltages are reversed*

Synchronism signal:

- is activated and maintained, after synchronism has been reached, for at least 0.2 s
- is deactivated when synchronism ends or the circuit-breaker is opened (with condition: *Evaluate CB status* = enabled) or communication with Ekip Touch is interrupted

Additional functions Certain options can be remotely configured in the synchronism conditions described above:

- the open circuit-breaker condition can be added (disabled by default)
- removal of the frequency and phase controls can be disabled



IMPORTANT: to be able to disable the frequency and phase controls, first make sure that the required frequency and phase correspondence between external and internal contacts already exists

Connections For references about the connection and terminals, please consult document [1SDM000005A1001](#); use AWG 22-16 cables with 1.4 mm maximum outer diameter for the external cabling.

To connect the module to *Ekip Supply* and *Ekip Cartridge*, please consult document [1SDH002009A1503](#).

Power supply *Ekip Com Synchrocheck* is supplied directly by the *Ekip Supply* module to which it is connected.



NOTE: communication between *Ekip Touch* and the module is interrupted in the absence of auxiliary power supply

Input *Ekip Synchrocheck* has an input (V S1 - V S2) for reading voltage, operation of which is ensured within the ranges and with the performance given below:

Component	Operating range	Normal operating range	Accuracy ⁽¹⁾
Voltage	0 ÷ 120 VAC	10 ÷ 120 VAC	1 % ⁽²⁾
Frequency ⁽³⁾	30 ÷ 80 Hz	30 ÷ 80 Hz	0,1 % ⁽⁴⁾
Phase ⁽⁵⁾	-	-180 ÷ +180 °	1 °

⁽¹⁾ the accuracy values refer to normal operating ranges, as established by IEC 61557-12

⁽²⁾ with busbar activated

⁽³⁾ with the busbar activated, frequency measurement starts at ≥ 36 V AC and ends at ≤ 32 V AC measured voltage

⁽⁴⁾ in the absence of harmonic distortion

⁽⁵⁾ phase measurement refers to the phase difference between internal and external voltage

Isolation transformer

An isolating transformer with the characteristics given below must always be installed between the external contacts of the circuit-breaker and the input of the module:

Characteristics	Description
Mechanical	<ul style="list-style-type: none"> fixing: EN 50022 DIN 43880 rail material: self-extinguishing thermoplastic protection class: IP30 electrostatic protection: with earth connector shield
Electrical	<ul style="list-style-type: none"> accuracy class: $\leq 0,2$ performance: ≥ 4 VA overload: 20% permanent insulations: 4 kV between inputs and outputs, 4 kV between screen and outputs, 4 kV between screen and inputs frequency: 45 to 66 Hz

Output *Ekip Synchrocheck* has an output (K S1 - K S2) used as synchronism contact.

The output is insulated from the unit and input, and has the following electrical characteristics:

Characteristics	Maximum limit ⁽¹⁾
Maximum switchable voltage	150 VDC / 250 VAC.
Breaking capacity	2 A @ 30 VDC, 0,8 A @ 50 VDC, 0,2 A @ 150 VDC, 4 A @ 250 VAC
Dielectric strength between open contacts	1000 V AC (1 minute @ 50 Hz).
Dielectric strength between each contact and coil	1000 V AC (1 minute @ 50 Hz).

⁽¹⁾ data relating to a resistive load

Interface the module has three signaling leds:

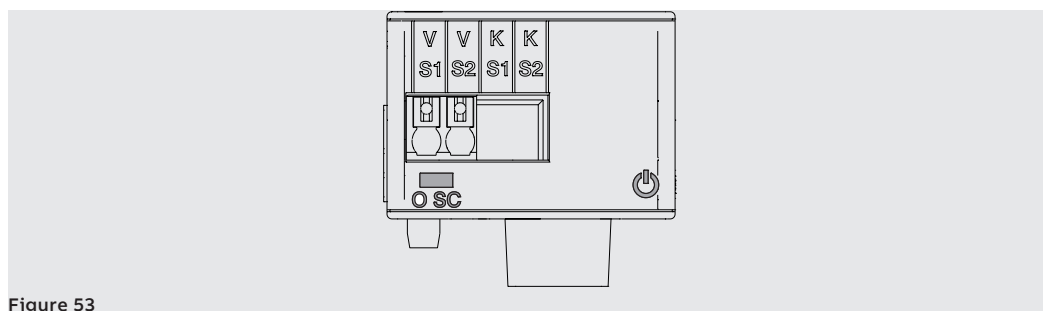



Figure 53

LEDs	Description
Power	Signals the on status and correct communication with Ekip Touch: <ul style="list-style-type: none"> • off: module off • on steady or flashing synchronized with the Power led of Ekip Touch: module on and communication with Trip unit present, flashing not synchronized with the Power led of Ekip Touch (two fast flashes per second): module on and communication with Trip unit absent
O SC	Indicate the status of the contacts of each output: <ul style="list-style-type: none"> • off: contact open • on: contact closed <p> NOTE: The LED displays the state of the output: it can indicate synchronization OK or KO, depending on the contact rest configuration (normally open or closed)</p>

Configurations via menu The specific configuration area will activate in the *Advanced - Synchrocheck* menu if the *Ekip Synchrocheck* module is detected correctly by Ekip Touch.

Parameter	Description	Default
<i>Enable</i>	Activates/deactivates the protection and its availability in the parameters menu	Off
<i>Dead bar option</i>	On = busbar activated; Off = dead busbar present	Off
<i>Udead Threshold</i> ⁽¹⁾⁽²⁾	Maximum external voltage (with dead busbar and configuration: <i>Normal</i> ⁽²⁾ is the first synchronism condition) The value is given as both absolute value (V) and relative value (Un) and can be set within the range: 0.02 Un to 2 Un, in 0.001 Un steps	0.2 Un
<i>Ulive Threshold</i> ⁽²⁾⁽³⁾	Minimum voltage for starting monitoring of external voltage (with busbar activated) or internal voltage (with dead busbar and <i>Normal</i> configuration) The value is given as both absolute value (V) and relative value (Un) and can be set within the range: 0.5 Un to 1.1 Un, in 0.001 Un steps	0.5 Un
<i>Stability Time</i>	Minimum time within which the <i>Ulive Threshold</i> condition must be obtained in order to activate voltage monitoring The value is given in seconds and can be set within the range: 100 ms to 30 s, in 1 ms steps	1 s
<i>Delta Voltage</i>	Maximum difference between internal and external voltage (first synchronism condition) The value is given as both absolute value (V) and relative value (Un) and can be set within the range: 0.02 Un to 0.12 Un, in 0.001 Un steps	0.12 Un
<i>Delta frequency</i> ⁽⁴⁾	Maximum difference between internal and external frequency (second synchronism condition) The value is given in Hertz and can be set within the range: 0.1 Hz to 1 Hz in 0.1 Hz steps	0.1 Hz
<i>Delta phase</i> ⁽⁴⁾	Maximum difference between internal and external phase (third synchronism condition) The value is given in degrees and can be set within the range: 5° to 50° in 5° steps	50 °
<i>Dead bar configuration</i>	With dead busbar and generator: <ul style="list-style-type: none"> • Reversed = <i>Ekip Synchrocheck</i>/external contacts connected to the generator • Normal = <i>Ekip Synchrocheck</i>/external contacts connected to the grid 	Standard
<i>Auto Live-dead detect</i>	Enables automatic synchronism control to be activated: <ul style="list-style-type: none"> • Manual = Ekip Touch considers the <i>Dead bar option</i> parameter • Automatic = Ekip Touch automatically assesses the configuration to be actuated between the dead busbar and active busbar 	Manual
<i>Auto Deadbar detect</i>	Configuration for detecting dead busbar: <ul style="list-style-type: none"> • Manual = Ekip Touch considers the <i>Dead bar configuration</i> parameter • Automatic = Ekip Touch automatically assesses the configuration to be actuated between: <i>Reversed</i> and <i>Normal</i> 	Manual
<i>Primary voltage</i>	Rated voltage Un of installation; the value is given as absolute value (V) and can be set within the range: 100 V to 1150 V in variable steps.	100 V

Continued on the next page

Parameter	Description	Default
Secondary voltage	Secondary voltage of the transformer; the value is given as absolute value (V) and can be set within the range: 100 V to 120 V in variable steps.	100 V
Concatenated Ref	Line-to-line voltage entering the module among the 3 installation voltages	U12
Contact Type	Defines the rest status of the contact with synchronism not present between: open (NO) and closed (NC)	NO

⁽¹⁾ parameter not available with busbar active and Auto deadbar detect= Manual

⁽²⁾ with dead busbar and configuration: Reversed, the roles of the internal and external voltages are reversed

⁽³⁾ 10% hysteresis is applied to the minimum voltage condition: once reached, the condition is lost if the voltage drops below 90% of the set limit

⁽⁴⁾ parameter not available with dead busbar and Auto deadbar detect= Manual



NOTE: all the thresholds have $\pm 10\%$ tolerance with the exception of:

- Voltage Delta; the tolerance is the higher value between: $\pm 10\%$ of the set threshold and $0.5\% U_n$ (with $U_n > 220\text{ V}$) or $1\% U_n$ (with $U_n \leq 220\text{ V}$)
- Frequency Delta; the tolerance is the higher value between $\pm 10\%$ of the set threshold and 0.02 Hz

Remote configurations

Additional parameters can be accessed via the service connector (via Ekip Connect) or via a system bus communication:

Parameter	Description	Default
Frequency check	Activates (ON) or deactivates (OFF) frequency control for synchronism assessment	ON
Phase check	Activates (ON) or deactivates (OFF) phase control for synchronism assessment	ON
Evaluate CB status	Activates (YES) or deactivates (NO) circuit-breaker open status control for synchronism assessment NOTE: fourth synchronism condition with busbar active; second synchronism condition with dead busbar	NO
Minimum matching time	With active busbar, minimum time within which the Delta Phase condition must be obtained The value is given in seconds and can be set within the range: 100 ms to 3 s, in 10 ms steps NOTE: this is not a synchronism condition, but a parameter allowing a discrimination to be made between correct and incorrect combinations of the Delta Frequency and Delta Phase conditions. Owing to worst case latencies, the time that effectively elapses before synchronism is recognized may be longer than the set time (approx. 20 ms)	100 ms

Measurements The specific measurement area will activate in the *Measurements - Synchrocheck* menu if the *Ekip Synchrocheck* module is detected correctly by Ekip Touch.

Measurement	Description
<i>Module</i>	<ul style="list-style-type: none"> • Ok = Synchronism conditions fulfilled • Not Ok = Synchronism conditions not fulfilled or function disabled
<i>Frequency</i>	<ul style="list-style-type: none"> • Ok = Synchronism condition regarding frequencies fulfilled • Not Ok = Synchronism condition regarding frequencies not fulfilled or synchronism function disabled, or frequencies outside measuring range limits. • --- = Synchronism condition regarding frequencies not available (example: for operation with dead busbar)
<i>Voltage</i>	<ul style="list-style-type: none"> • Ok = Synchronism conditions regarding voltages fulfilled. • Not Ok = Synchronism conditions regarding voltages not fulfilled or synchronism function disabled
<i>Phase</i>	<ul style="list-style-type: none"> • Ok = Synchronism condition regarding phase difference fulfilled • Not Ok = Synchronism condition regarding phase difference not fulfilled or synchronism function disabled, or frequencies outside measuring range limits • --- = Synchronism condition regarding phase difference not available (example: for operation with dead busbar)
<i>Ext Side Voltage</i> ⁽¹⁾	<ul style="list-style-type: none"> • Voltage measured by <i>Ekip Synchrocheck</i> given in Volts • = measurement DC or less than 1 VAC • --- = measurement not available (example: because synchronism function is disabled)
<i>Int Side Voltage</i> ⁽²⁾	<ul style="list-style-type: none"> • Voltage measured on internal sockets, given in Volts. • = measurement less than 1 VAC
<i>Ext Side Frequency</i> ⁽¹⁾	<ul style="list-style-type: none"> • Frequency measured by <i>Ekip Synchrocheck</i> • --- = measurement not available (example: because synchronism function is disabled, or operation with dead busbar, or frequencies outside measuring range limits)
<i>Int Side Frequency</i> ⁽²⁾	<ul style="list-style-type: none"> • Frequency measured on internal sockets • --- = measurement not available (example: because synchronism function is disabled, or operation with dead busbar, or frequencies outside measuring range limits)
<i>Phase Difference</i> ⁽¹⁾	<ul style="list-style-type: none"> • Phase difference between voltages, given in degrees • --- = measurement not available (example: because synchronism function is disabled, or operation with dead busbar, or frequencies outside measuring range limits)
<i>Auto detection</i>	<ul style="list-style-type: none"> • Busbar active = with automatic detection of operating mode and operation with active busbar, or with synchronism function not enabled • Dead bar = with automatic detection of operating mode and operation with dead busbar • --- = Measurement not available (example: owing to manual detection of operating mode)
<i>Voltage relation</i>	<ul style="list-style-type: none"> • $V_{int} \leq V_{ext}$ = Internal voltage the same as external voltage or lower • $V_{in} > V_{ext}$ = Internal voltage higher than external voltage • --- = Measurement not available (example: because the synchronism function is disabled, or direct voltages or voltages lower than 1 V).
<i>Frequency relation</i>	<ul style="list-style-type: none"> • $f_{int} \leq f_{ext}$ = Internal frequency the same as external frequency or lower • $f_{in} > f_{ext}$ = Internal frequency higher than external frequency • --- = Measurement not available (example: because synchronism function is disabled, or operation with dead busbar, or frequencies outside measuring range limits)

⁽¹⁾ voltage difference measurement accuracy is $\pm 10\%$ unless the parameter value is $0.02 U_n$, in which case accuracy is $\pm 20\%$

⁽²⁾ the characteristics of the voltage and frequency measurements coincide with those given on the internal sockets (page 100)

Summary page The summary page is activated in the presence of the *Ekip Synchrocheck* module; access is obtained in the same way as the other summary pages

The measurements in this page are:

- V int: voltage read by Ekip Touch
- f int: frequency read by Ekip Touch
- $\Delta\phi$: phase difference
- SYNC: status of synchronism

About The *About - Modules* menu contains the specific menu of the module with the serial number and version of the module itself.

Remote information Certain additional information concerning the version and status of the module is available via the service connector (via Ekip Connect) or by communication via system bus; the information includes: HW and Boot version, CRC status (correctness of the SW in the module).

15 - Ekip Signalling 3T

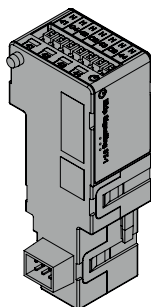

Ekip Signalling 3T is a signaling accessory which enables the connection of:

- three analog inputs for PT100/PT1000 temperature sensors (2 wires): I42, I43, I44
- an analog input for 4-20 mA current loop: I41

The measurements supplied by the module can be associated with different control threshold, useful for configuring alarm signals, states and programmable commands.

Accessories *Ekip Cartridge* and *Ekip Supply* are required in order to connect *Ekip Signalling 3T* to Ekip Touch (page 130, 131).

Models Ekip Touch can be configured with two different 3T modules: *Ekip Signalling 3T-1* and *Ekip Signalling 3T-2*.

i **NOTE:** if different indications are not given, the information in the next chapter is valid for both models; on the second module the inputs are called I51 (loop 4-20 mA), I52, I53, I54 (PT100/PT1000)

The two modules can be installed at the same time on the same circuit-breaker so as to extend the opportunities for measuring and monitoring the installation.

! **IMPORTANT:** each circuit-breaker can only be fitted with one module per type. Configuration with two modules of the same model is not allowed (example: two Ekip Signalling 3T-1 modules)

Connections For references about the connection and terminals, please consult document [1SDM000005A1001](#)

To connect the module to Ekip Touch, please consult document [1SDH001000R0527](#).

For PT100/PT1000 sensors, use insulated cables for resistance thermometers such as PENTRONIC TEC/SITW-24F (Type TX) or similar. Maximum length 3 meters.

For the 4-20 mA Current Loop sensor, use suitable cables up to 3 meters in length compatible with the workplace in which the 4-20 mA current sensor is used.

! **IMPORTANT:** the inputs are not insulated: regardless of plant voltage, the customer must ensure there is insulation between each input and between the inputs and power supply of the Ekip Supply module on the basis of the customer's own application and network.

For applications in low voltage installations ABB suggests use of the external probe PT1000 3mt, is equipped with a nut and screw for use on busbars and is compatible with the dielectric withstand and insulation levels established by standard IEC 60947-2 (U_i= 1000 V, U_{imp}= 12 kV).

Power supply *Ekip Signalling 3T* is supplied directly by the *Ekip Supply* module to which it is connected.

i **NOTE:** communication between Ekip Touch and the module is interrupted in the absence of auxiliary power supply

Input The module enables the following quantities to be measured

Input	Measurement	Range	Resolution	Accuracy ⁽¹⁾
PT100/PT1000	Temperature	-50 ÷ 250 °C ⁽²⁾	0,01 °C	± 1 °C ⁽⁵⁾
Current loop 4-20 mA	DC current	0 ÷ 100 % ⁽³⁾	0.1 %	± 0,5 % ⁽⁴⁾

⁽¹⁾ accuracy values refer to 3T module without sensors. For complete accuracy, consider the characteristics of the sensors and cabling used; accuracy increases by 0.5 °C with the ABB sensor

⁽²⁾ with ABB PT1000 sensor, the range is -25 ÷ 150 °C

⁽³⁾ the measurement is expressed as a percentage, where: 0% = 4 mA and 100% = 20 mA

⁽⁴⁾ accuracy values refer to full scale: 0.5% = 0.1 mA

⁽⁵⁾ Accuracy valid within the 0 to 130 °C range with module at 25 °C ambient temperature. The accuracy value is ± 2 °C over the whole range, with module at 25 °C ambient temperature

Interface Five signalling leds are available:

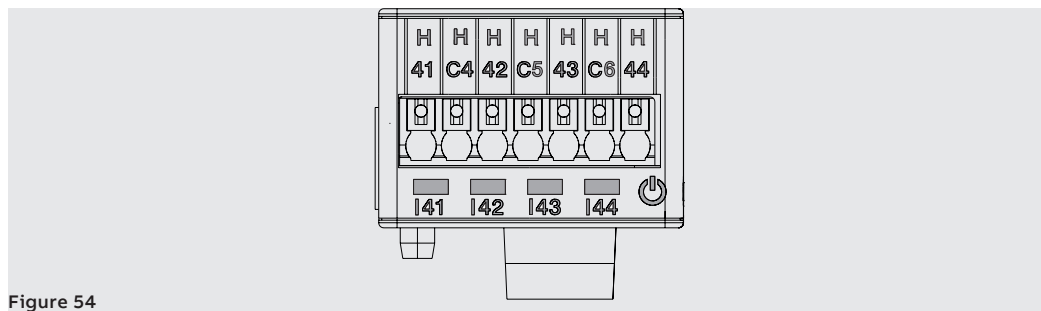

Figure 54

LEDs	Description
Power	<p>Signals the on state and correct communication with the trip unit:</p> <ul style="list-style-type: none"> • off: module off • on steady or flashing synchronized with the trip unit Power led: module on and communication with trip unit present • flashing not synchronized with trip unit Power led (two fast flashes per second): module on and communication with trip unit absent
I 41, I 42, I 43, I 44	<p>Indicate the state of the input contacts:</p> <ul style="list-style-type: none"> • off: input disabled • on steady: input enabled, sensor connected and measurement valid • flashing: input enabled, sensor not connected and/or measurement not valid

Access from the display The following areas are activated on Ekip Touch if the Ekip Signalling 3T module is detected correctly:

- *Measurements* page, accessible from the Home page, containing the measurements of all the PT100/PT1000 and 4-20 mA Current Loop inputs of both modules 3T-1 and 3T-2
- information submenus in the *About-Modules* menu containing: serial number, module version and statuses of sensors (Present/Alarm)



IMPORTANT:

- if one or more sensors are in the alarm status, the signal on the diagnosis bar will be: **Ekip Signalling 3T**
- if a sensor is not enabled, the status indicated is: **Present**

Remote configurations The configuration of the module is available:

- via Ekip Connect, with communication accessories via service connector or with communication via system bus
- via own communication system and *Ekip Com* modules installed on circuit-breaker, in the conditions required by the trip unit (use System Interface for details)

All the measurements, states and alarms of the module are available in both conditions.



NOTE: *parameters and measurements are distributed in Ekip Connect pages and communication addresses sometimes nonsequential; references to the pages in Ekip Connect 3 are given in the tables below*

Enabling and measurements The individual inputs of the module can be enabled in the *Ekip Signalling 3T* page: I42 Temperatures, I43 Temperatures, I44 Temperatures, I41 Current 4-20 mA (per 3T-1), I52 Temperatures, I53 Temperatures, I54 temperatures, I51 Current 4-20 mA (for 3T-2).

Parameter	Description	Default
<i>Enable</i>	Enables the specific input and relative alarm state and signaling controls to be activated	Enabled

Alarm signals Up to three alarm thresholds (independent of each other), Threshold A, Threshold B, Threshold C, can be activated and configured for each input in the *Protection parameters - Other parameters A* (and B if dual set is activated) page

Each alarm threshold has the following configuration parameters:



NOTE: the table lists the parameters of threshold A of input I42; the names and references of all the other thresholds and inputs change

Parameter	Description	Default
<i>Threshold A enable</i>	Activates verification of input I42 with alarm Threshold A	Off
<i>Threshold A hysteresis direction</i>	Defines whether the alarm must activate when measurement is above (<i>Up</i>) or below (<i>Down</i>) the set value, with reference to the Threshold A setting	Up
<i>Threshold A value</i>	Alarm threshold A of input I42. The value is given in degrees Celsius (°C) and can be set within the range: -40°C to 240°C, in 0.1°C steps. NOTE: the thresholds of the 4-20 mA (I41 and I51) Current Loop input are given in percentage form and can be set within the range: 0% to 100 %, in 0.1% steps (each step equivalent to 0.016 µA)	200 °C (I42, I43, I44, I52, I53, I54) / 50 % (I41, I51)
<i>Threshold A hysteresis</i>	Hysteresis value, valid for quitting the alarm condition if the set Threshold A alarm threshold has been exceeded. The hysteresis parameter only allows positive values. The trip unit decides whether to add or subtract this value to or from the alarm threshold on the basis of the direction parameter, example: • <i>Direction = Up, Value = 200°C, hysteresis= 10°C</i> , the alarm activates over 200° and de-activates below 190°C The value is expressed in degrees Celsius (°C) and can be set within the range: 0°C to 50°C with 0.1°C steps. NOTE: the thresholds associated with the 4-20 mA (I41 and I51) Current Loop input are given in percentage form and can be set within the range 0% to 30 %, in 0.1% steps (each step equivalent to 0.016 µA)	1 °C (I42, I43, I44, I52, I53, I54) / 1 % (I41, I51)

States and alarms The state of all control thresholds can be checked in the *Warnings/Alarms* page

16 - Ekip CI

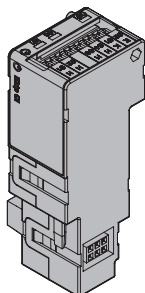

Ekip CI is an accessory module configurable with *Ekip M Touch*, which enables a remote control switch to be managed in the *Normal* configuration (page 121).

This module has:

- a contact for controlling a remote control switch
- an input for temperature probe PT100 (2 wires)
- a digital input for the Trip Reset function
- led for signaling the startup status and operating status of the module

Accessories *Ekip Cartridge* and *Ekip Supply* are required in order to connect *Ekip Com Hub* to *Ekip Touch* (page 130, 131).

Connections For references about the connection and terminals, please consult document [1SDM000068R0001](#); for input I61, use insulated cables for resistance thermometers such as PENTRONIC TEC/SITW-24F (Type TX) or similar. Maximum length 3 meters. The circuit diagrams are

To connect the module to *Ekip Supply* and *Ekip M Touch*, please consult document [1SDH002009A1503](#).



IMPORTANT: input I61 is not insulated: regardless of plant voltage, the customer must ensure there is insulation between the input and power supply of the Ekip Supply module on the basis of the customer's own application and network

Power supply *Ekip CI* is supplied directly by the *Ekip Supply* module to which it is connected.



NOTE: in the absence of auxiliary power supply, communication between *Ekip M Touch* and the module is interrupted, the output contact maintains its status and the input signals are no longer valid.

Output Output contact O61 (K61 and K62), which is normally closed, is opened if a TRIP occurs.

Re-closing can be obtained after a command on the *Trip Reset* input or if the *Autoreclosure* function is active, after the time defined by the user (*Autoreclosure Time*).

The contact has the following electrical characteristics:

Characteristics	Maximum limit ⁽¹⁾
Rated breaking capacity	8A @ 250 VAC / 5A @ 30 VDC
Minimum breaking capacity	10 mA @ 5 VDC
Insulation resistance between contact and Trip unit	1000 MΩ, 50 VDC

⁽¹⁾ data relating to a resistive load

Input PT100 Analog input I61 (H61 and H62) allows a thermocouple to be connected (model PT100) so as to monitor the temperature and, if *PTC protection* is activated, to manage a TRIP if an alarm occurs (120 °C fixed threshold) (page 72)

The contact has the following measuring characteristics:

Input	Measurement	Range	Resolution	Accuracy ⁽¹⁾
PT100	Temperature	-50 ÷ 250 °C	0,01 °C	± 0,25 °C ⁽²⁾

⁽¹⁾ accuracy values refer to *Ekip CI* module without sensor. For complete accuracy, consider the characteristics of the sensor and cabling used

⁽²⁾ accuracy valid in -25 to 250°C range; in complete range it is: ± 0.5 °C

Input Trip reset Digital input I63 (H63 and H64) allows contact O61 to be re-opened after a TRIP.

The module permits two logic statuses, interpreted differently by the Trip unit on the basis of the polarity configured by the user:

State	Electrical condition	Polarity	Status detected (and command required)
Open	Circuit open ⁽¹⁾	Active open	On (O61 open command)
		Active closed	Off
Closed	Short-circuit ⁽²⁾	Active open	Off
		Active closed	On (O61 open command)

⁽¹⁾ $R > 100 \text{ k}\Omega$

⁽²⁾ $R (\text{wiring} + \text{short circuit contact}) < 25 \Omega$

The re-closing command is activated at the front.

Interface The module has four signaling leds:

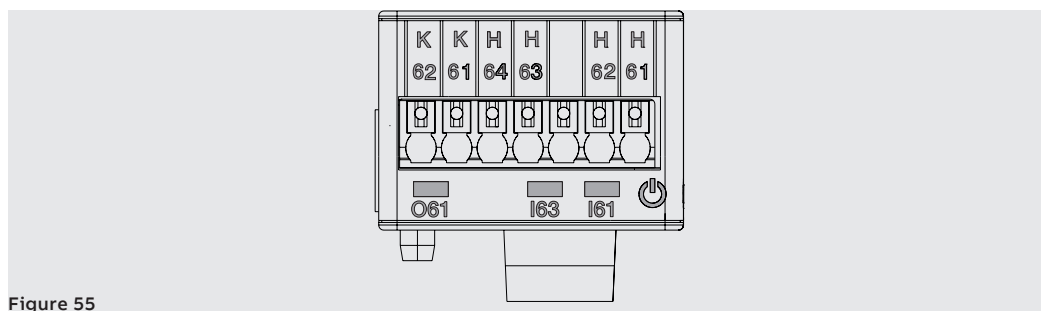



Figure 55

Parameter	Description
Power	Signals the on status and correct communication with Ekip Touch: <ul style="list-style-type: none"> • off: module off • on steady or flashing synchronized with the Power led of Ekip Touch: module on and communication with Trip unit present • flashing not synchronized with the Power led of Ekip Touch (2 fast flashes per second): module on and communication with trip unit absent
I 61	Status of input for temperature probe PT100 I61: <ul style="list-style-type: none"> • off: input disabled • on: input enabled and sensor present • flashing: input enabled and sensor disconnected or signal not valid
I 63	Indicates the status of the digital input for Trip Reset I63: <ul style="list-style-type: none"> • off: input open • on: input closed
O 61	Indicates the status of the command contact of remote control switch O61: <ul style="list-style-type: none"> • off: contact closed • on: contact open

Menu Local bus activation, which is essential for starting communication between the module and Trip unit, is available in the *Settings* menu (page 35).

The specific configuration, measurement, test and information areas will activate in the respective menus if the *Ekip CI* module is detected correctly by Ekip Touch.

Configuration The module parameters can be configured in the *Settings-Modules-Ekip CI* menu:

Parameter	Description	Default
<i>Enable</i>	Activates/deactivates certain functions and their availability in the parameters menu: <ul style="list-style-type: none"> • if On: all the inputs, outputs and relative functions are activated • if Off: only input I61 is activated: the command function of O61 is off 	Off
<i>Polarity</i>	Defines whether input I63 is interpreted as On by Ekip Touch when it is open (<i>Active open</i>) or when it is closed (<i>Active Closed</i>)	Active closed
<i>Delay</i>	Minimum activation time of input I63 before the re-opening command of contact O61 is sent; the delay is given in seconds and can be set within range: 0 s to 100 s, in 0.01 s steps  NOTES : <ul style="list-style-type: none"> • if the input is deactivated before this time has elapsed, the re-opening command is not sent • if delay = 0 s the input must still be present for longer than 300 µS 	0.1 s

Measurements The specific area of the module, containing the temperature measurement of probe PT100 if connected and activated, will be available in the *Measurements* menu if *Ekip CI* is correctly detected by Ekip Touch.



NOTE: value “ - - ” will be displayed if no probe is detected

Test The test area in the *Test* menu is activated if the *Ekip CI* module is detected correctly.
For details of the test characteristics, please consult page 36.

About If *Ekip CI* is detected correctly by Ekip Touch, the specific area of the module will be available in the *About-Modules* menu, containing:

- the serial number and version of the module
- activation status of the input for temperature probe PT100

Remote information Certain additional information concerning the version and status of the module is available via the service connector (via Ekip Connect) or by communication via system bus; the information includes: HW and Boot version, CRC status (correctness of the SW in the module).

Internal accessories

1 - Ekip Com Modbus RTU

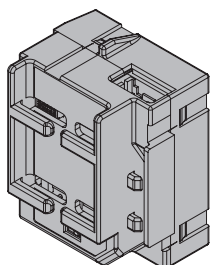

Ekip Com Modbus RTU is a communication accessory which allows Ekip Touch to be integrated into an RS-485 network with Modbus RTU communication protocol, with remote supervision and monitoring functions.

You can perform the following operations remotely:

- read Ekip Touch measurements and information
- provide information about the status of the circuit-breaker (open, closed, tripped)
- manage certain controls, including opening and closing the actuator (MOE-E)
- access information and parameters not available on the display



NOTE: *the remote open and close commands of the circuit-breaker can only be executed if Ekip Touch is in the Remote configuration*

The System Interface document is available for mapping the module in its communication network. All the required communication and command details are listed in the document (page 129).



IMPORTANT: **each circuit-breaker can house one module only; configuration with external communication modules is not allowed if an internal module is present**

Connections To connect the module to its communication network and for references about the terminals, please consult circuit diagrams [1SDM000005A1001](#).

The module is supplied with a 1-meter length cable for interfacing with its network.



NOTE: *different cables are supplied, depending on whether the circuit-breaker version is fixed/plug-in or withdrawable. For further details, please consult document [1SDH002011A1506](#)*

To connect the module to Ekip Touch, please consult document [1SDH002011A1506](#).

Power supply *Ekip Com Modbus RTU* is supplied directly by the Ekip Touch to which it is connected.



NOTE: *communication between Ekip Touch and the module is interrupted in the absence of auxiliary power supply*

Configurations via menu Local bus activation, which is essential for starting the communication between module and Ekip Touch, is available in the *Settings* menu (page 35).

Two areas are activated if Ekip Touch detects the module correctly:

- information area in the *About-Modules* menu, containing the software version and serial number of the module
- specific configuration area in the *Settings-Modules* menu, where the following communication parameters can be configured:

Parameter	Description	Default
<i>Serial address</i>	Module address; 1 to 247 range available  IMPORTANT: devices connected to the same network must have different addresses	247
<i>Baudrate</i>	Data transmission speed; 3 options are available: 9600 bit/s, 19200 bit/s, 38400 bit/s	19200 bit/s
<i>Physical protocol</i>	Defines the stop and parity bit; 4 options are available: <ul style="list-style-type: none"> • 8,E,1 = 8 data bits, 1 EVEN parity bit, 1 STOP bit • 8,O,1 = 8 data bits, 1 ODD parity bit, 1 STOP bit • 8,N,2 = 8 data bits, no parity bit, 2 STOP bits • 8,N,1 = 8 data bits, no parity bit, 1 STOP bit 	8,E,1



NOTE: 247 default of Ekip Com Modbus RTU module

Remote configurations The operating configuration can be changed from slave to master via the service connector (via Ekip Connect) or via a system bus communication as as to integrate the module into an interactive data exchange network (see description of Ekip Com Hub, page 159).



IMPORTANT:

- **In the Master configuration, the module does not allow data exchange as in the normal Slave function**
- **the presence of several masters in the same network can cause faulty operation**

Remote information Certain additional information concerning the version and status of the module is available via the service connector (via Ekip Connect) or by communication via system bus; the information includes: HW and Boot version, CRC status (correctness of the SW in the module).

2 - Ekip Com Modbus TCP

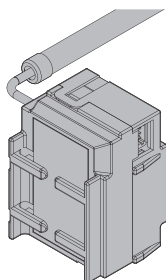

Ekip Com Modbus TCP is a communication accessory which allows Ekip Touch to be integrated into an Ethernet network with Modbus TCP communication protocol, with remote supervision and monitoring functions.

The module is configured as master and remotely, you can:

- read Ekip Touch measurements and information
- provide information about the status of the circuit-breaker (open, closed, tripped)
- manage certain controls, including opening and closing the actuator (MOE-E)
- access information and parameters not available on the display



NOTE: *the remote open and close commands of the circuit-breaker can only be executed if Ekip Touch is in the Remote configuration*

The System Interface document is available for mapping the module in its communication network. All the required communication and command details are listed in the document (page 129).

Depending on the parameter settings, described in the next pages, the ports used by the module are:

Port	Service	Notes
502/TCP	Modbus TCP	Valid for the Modbus TCP mode
319/UDP	IEEE 1588	Valid with IEEE 1588 protocol enabled
320/UDP		
68/UDP	DHCP client	DHCP client enabled alternatively as: <i>Static address = On</i>



IMPORTANT: *each circuit-breaker can house one module only; configuration with external communication modules is not allowed if an internal module is present.*

Safety and cyber security

Since the module allows the actuator connected to Ekip Touch and access to the data in the unit to be checked, it can only be connected to networks equipped with all the necessary security and prevention measures against unauthorized access (for example, the network of the control system of an installation).



IMPORTANT:

- **it is the customer's sole responsibility to provide and continuously ensure a secure connection between the module and customer network or any other network (as the case may be). The plant manager must establish and maintain appropriate measures (such as but not limited to the installation of firewalls, application of authentication measures, encryption of data, installation of antivirus programs, etc.) to protect the product, the network, the customer system and interface against any kind of security breaches, unauthorized access, interference, intrusion, loss and/or theft of data or information. ABB and its affiliates are not liable for damages and/or losses related to such security breaches, unauthorized accesses, interference, intrusion, loss and/or theft of data or information.**
- **The module cannot be connected directly to the Internet. Only connect to dedicated Ethernet networks with Modbus TCP communication protocol**

Connections

To connect the module to its communication network and for references about the terminals, please consult document [1SDM00005A1001](#).

The module is supplied with a 1-meter length cable and cabled RJ45 connector for interfacing with its network.

To connect the module to Ekip Touch, please consult document [1SDH002011A1503](#).

Power supply *Ekip Com Modbus TCP* is supplied directly by the *Ekip Touch* module to which it is connected.



NOTE: communication between *Ekip Touch* and the module is interrupted in the absence of auxiliary power supply

Configurations via menu Local bus activation, which is essential for starting the communication between module and *Ekip Touch*, is available in the *Settings* menu (page 129).

The following communication parameters can be configured if the module has been correctly detected by *Ekip Touch* in the *Settings-Modules* menu:

Parameter	Description	Default
<i>Static IP address ON</i>	Defines whether the module has the dynamic (Off) or static (On) IP address. Se = On all the associated parameters are enabled	Off
<i>Static address IP address</i>	Enables the static IP to be selected	0.0.0.0
<i>Static Network Mask</i>	Enables the subnet mask to be selected	0.0.0.0
<i>Static Gateway address</i>	When there are several subnets, enables the IP address of the node to which the module is connected to be selected	0.0.0.0

Information in menu The following information will be available in the *About-Modules* menu if *Ekip Touch* has detected the module correctly:

Information	Description
<i>SN and version</i>	Identifier and SW version of the module
<i>IP address</i>	Address of the module, assigned to the module by a DHCP server at the time of connection to the network in the case of configuration with a dynamic IP, or can be set via the menu in the event of a static IP NOTE: without a DHCP server, the module automatically adopts a random IP address within the 169.254.xxx.xxx range
<i>Network Mask</i>	Subnet mask; identifies the method for recognizing the subnet to which the modules belong and enables modules to be searched for within a defined set of recipients.
<i>Gateway address</i>	IP address of the node to which the module is connected, in the presence of several subnets
<i>TCP Client 1, 2, 3</i>	IP addresses of the client devices connected to the module (in the Server mode)
<i>MAC address</i>	Address assigned by ABB, with OUI (Organizationally Unique Identifier) equal to ac:d3:64, which uniquely identifies the manufacturer of an Ethernet device

Remote configurations

Additional parameters can be accessed via the service connector (via Ekip Connect) or via a system bus communication:

Parameter	Description	Default
Client/Server	Parameter for changing the configuration of the module from Server Only to Client and Server and for integrating it into an interactive data exchange network (see Ekip Com Hub on page 159) ! IMPORTANT: if Client/Server, the module allows data exchange like a normal Server function	Server only
IEEE 1588 enable	Allows the IEEE 1588 protocol for distribution of the clock and synchronization signal to be enabled ⁽¹⁾ .	OFF
Master IEEE 1588	Enables the module to be set up as a master in the the network segment to which it belongs (synchronization clock).	OFF
IEEE 1588 delay mechanism	Allows the data exchange mode between module and master, either Peer-to-Peer or End-to-End, to be selected.	End-to-End
SNTP Client enable	Allows the SNTP protocol for distribution of the clock and synchronization signal to be enabled ⁽¹⁾	OFF
Force Static IP Address	Allows the network server that supplies the SNTP to be set.	0.0.0.0
Time zone	Defines the time zone to be used for synchronism	+00:00
Daylight Saving Time	Used to select whether daylight saving time is present (ON) or not (OFF) in the country to which the synchronization time refers	OFF
Disabilita Gratuitous ARP	Permits (Enabled ARP) the periodic generation of a Gratuitous ARP message, used by Ekip Connect to rapidly find the modules via Ethernet scan without knowing the IP address beforehand	ARP Enabled
Access protected by password	Enables the writing operations performed via the network to be protected by a password (Request password)	Standard mode
IEEE 1588 Boundary clock	Parameter useful if an IEEE 1588 GrandMaster clock is not available: • If enabled (ON), the module is seen as an IEEE1588 master clock by all the slaves/devices in the same local network, even when the source of external synchronism is different from IEEE 1588 (SNTP for example) • If disabled (OFF) the module benefits from the synchronism of the master in its own network)	OFF
Enable package Limitation	Enables the Rate limiter function, which limits the number of packages entering the module from the network, to be activated/deactivated	Disable

⁽¹⁾ Enable IEEE 1588 and Enable SNTP client must not be enabled at the same time

⁽²⁾ the parameter can only be changed via system bus in the remote configuration

Remote information

Additional information can be accessed via the service connector (via Ekip Connect) or via a system bus communication:

Information	Description
Boot and HW version	General module information
Flash CRC status e result	Information about the correctness of the SW in the module
Stato Ekip Link	Signals Ethernet cable connection errors
SNTP Server Error	Error in communication with SNTP server
SNTP Server Synchronisation	State of synchronism with SNTP server
IEEE 1588 status	Valid with Master IEEE 1588= ON, notifies the presence (Slave or PTP Master Active) or absence (PTP Master but Passive) of the higher level master

3 - Ekip Com Profinet

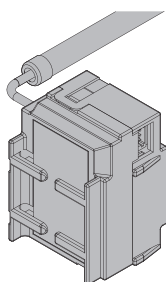

Ekip Com Profinet is a communication accessory which allows Ekip Touch to be integrated into an Ethernet network with Profinet communication protocol, with remote supervision and monitoring functions.

The module is configured as master and remotely, you can:

- read Ekip Touch measurements and information
- provide information about the status of the circuit-breaker (open, closed, tripped)
- manage certain controls, including opening and closing the actuator (MOE-E)
- access information not available on the display

i **NOTE:** *the remote open and close commands of the circuit-breaker can only be executed if Ekip Touch is in the Remote configuration*

The System Interface document is available for mapping the module in its communication network. All the required communication and command details are listed in the document (page 129).

The ports used by the module are:

Ethertype	Port	Service	Notes
0x88CC	-	LLDP	Link Layer Discovery Protocol
0x8892 (Profinet)	-	Profinet IO	Specific for real time communications (RT)
0x0800	34964/UDP	Profinet-cm (Context manager)	DCE/RPC

! **IMPORTANT:** **each circuit-breaker can house one module only; configuration with external communication modules is not allowed if an internal module is present.**

Safety and cyber security

Since the module allows the actuator connected to Ekip Touch and access to the data in the unit to be checked, it can only be connected to networks equipped with all the necessary security and prevention measures against unauthorized access (for example, the network of the control system of an installation).

! **IMPORTANT:**

- **it is the customer's sole responsibility to provide and continuously ensure a secure connection between the module and customer network or any other network (as the case may be). The plant manager must establish and maintain appropriate measures (such as but not limited to the installation of firewalls, application of authentication measures, encryption of data, installation of antivirus programs, etc.) to protect the product, the network, the customer system and interface against any kind of security breaches, unauthorized access, interference, intrusion, loss and/or theft of data or information. ABB and its affiliates are not liable for damages and/or losses related to such security breaches, unauthorized accesses, interference, intrusion, loss and/or theft of data or information.**
- **The module cannot be connected directly to the Internet. Only connect to dedicated Ethernet networks with Profinet communication protocol**

Connections

To connect the module to its communication network and for references about the terminals, please consult document [1SDM000005A1001](#).

The module is supplied with a 1-meter length cable and cabled RJ45 connector for interfacing with its network.

To connect the module to Ekip Touch and to actuator MOE-E if present, please consult document [1SDH002011A1503](#).

Power supply *Ekip Com Profinet* is supplied directly by the *Ekip Touch* module to which it is connected.



NOTE: communication between *Ekip Touch* and the module is interrupted in the absence of auxiliary power supply

Configurations via menu Local bus activation, which is essential for starting the communication between module and *Ekip Touch*, is available in the *Settings* menu (page 35).

The following information will be available in the *About-Modules* menu if *Ekip Touch* has detected the module correctly:

Information	Description
<i>SN and version</i>	Identifier and SW version of the module
<i>MAC address</i>	Address assigned by ABB, with OUI (Organizationally Unique Identifier) equal to ac:d3:64, which uniquely identifies the manufacturer of an Ethernet device

Remote configurations Additional parameters can be accessed via the service connector (via *Ekip Connect*) or via a system bus communication:

Parameter	Description	Default
<i>Data access mode</i>	Defines Dataset (acyclic data) access mode <ul style="list-style-type: none"> • each individual acyclic register can be accessed in the Legacy mode using the Slot, Subslot and Index fields (with Slot fixed at 3) • only complete blocks can be accessed in the Dataset mode; Slot is fixed at 0, Subslot at 1 and Index defines the block reference. See System Interface for details. 	Legacy
<i>Cyclic data endianness</i>	Establishes whether the register of the cyclic data item is configured in Big endian or Little endian.	Little endian
<i>Acyclic data endianness</i>	Establishes whether the register of the acyclic data item is configured in Big endian or Little endian.	Big endian

Remote information Certain integrative information concerning the version and state of the module is available via service connector (via *Ekip Connect*) or through communication via system bus, i.e., HW and Boot version, CRC state (correctness of SW in module), DCP Name, network settings (IP address, Network Mask, Gateway address)

4 - Ekip Com EtherNet/IP™

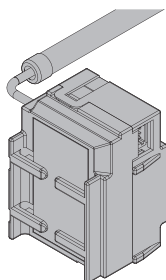

Ekip Com EtherNet/IP™ is a communication accessory which allows Ekip Touch to be integrated into an Ethernet network with EtherNet/IP™ communication protocol, with supervision functions

The module is configured as master and remotely, you can:

- read Ekip Touch measurements and information
- provide information about the status of the circuit-breaker (open, closed, tripped)
- manage certain controls, including opening and closing the actuator (MOE-E)
- access information and parameters not available on the display

i **NOTE:** *the remote open and close commands of the circuit-breaker can only be executed if Ekip Touch is in the Remote configuration*

The System Interface document is available for mapping the module in its communication network. All the required communication and command details are listed in the document (page 129).

Depending on the parameter settings, described in the next pages, the ports used by the module are:

Port	Description	Default
44818	TCP	Encapsulation Protocol (example: ListIdentity, UCMM, CIP Transport Class 3)
44818	UDP	44818 UDP Encapsulation Protocol (example: ListIdentity)
2222	UDP	2222 UDP CIP Transport Class 0 or 1
68/UDP	DHCP Client	Client DHCP enabled as an alternative to Static address = On

! **IMPORTANT:** **each circuit-breaker can house one module only; configuration with external communication modules is not allowed if an internal module is present.**

Safety and cyber security

Since the module allows the actuator connected to Ekip Touch and access to the data in the unit to be checked, it can only be connected to networks equipped with all the necessary security and prevention measures against unauthorized access (for example, the network of the control system of an installation).

! **IMPORTANT:**

- **it is the customer's sole responsibility to provide and continuously ensure a secure connection between the module and customer network or any other network (as the case may be). The plant manager must establish and maintain appropriate measures (such as but not limited to the installation of firewalls, application of authentication measures, encryption of data, installation of antivirus programs, etc.) to protect the product, the network, the customer system and interface against any kind of security breaches, unauthorized access, interference, intrusion, loss and/or theft of data or information. ABB and its affiliates are not liable for damages and/or losses related to such security breaches, unauthorized accesses, interference, intrusion, loss and/or theft of data or information.**
- **The module cannot be connected directly to the Internet. Only connect to dedicated Ethernet networks with EtherNet/IP™ communication protocol**

Connections

To connect the module to its communication network and for references about the terminals, please consult circuit diagrams [1SDM000005A1001](#).

The module is supplied with a 1-meter length cable and cabled RJ45 connector for interfacing with its network.

To connect the module to Ekip Touch and to actuator MOE-E if present, please consult document [1SDH002011A1503](#).

Power supply *Ekip Com EtherNet/IP™* is supplied directly by the *Ekip Touch* module to which it is connected.



NOTE: communication between *Ekip Touch* and the module is interrupted in the absence of auxiliary power supply

Configurations via menu Local bus activation, which is essential for starting the communication between module and *Ekip Touch*, is available in the *Settings* menu (page 35).

The following communication parameters can be configured if the module has been correctly detected by *Ekip Touch* in the *Settings-Modules* menu:

Parameter	Description	Default
<i>Static IP address ON</i>	Defines whether the module has the dynamic (Off) or static (On) IP address. Se = On all the associated parameters are enabled	Off
<i>Static address IP address</i>	Enables the static IP to be selected	0.0.0.0
<i>Static Network Mask</i>	Enables the subnet mask to be selected	0.0.0.0
<i>Static Gateway address</i>	When there are several subnets, enables the IP address of the node to which the module is connected to be selected	0.0.0.0

Information in menu The following information will be available in the *About-Modules* menu if *Ekip Touch* has detected the module correctly:

Parameter	Description
<i>SN and version</i>	Identifier and SW version of the module
<i>IP address</i>	Address of the module, assigned to the module by a DHCP server at the time of connection to the network in the case of configuration with a dynamic IP, or can be set via the menu in the event of a static IP NOTE: without a DHCP server, the module automatically adopts a random IP address within the 169.254.xxx.xxx range
<i>Network Mask</i>	Subnet mask; identifies the method for recognizing the subnet to which the modules belong and enables modules to be searched for within a defined set of recipients.
<i>Gateway address</i>	IP address of the node to which the module is connected, in the presence of several subnets
<i>MAC address</i>	Address assigned by ABB, with OUI (Organizationally Unique Identifier) equal to ac:d3:64, which uniquely identifies the manufacturer of an Ethernet device

Remote configurations

Additional parameters can be accessed via the service connector (via Ekip Connect) or via a system bus communication:

Parameter	Description	Default
<i>Enable IEEE 1588</i>	Allows the IEEE 1588 protocol for distribution of the clock and synchronization signal to be enabled ^(NOTE)	Off
<i>IEEE 1588 Master</i>	Enables the module to be set up as a master in the the network segment to which it belongs (synchronization clock).	Off
<i>IEEE 1588 Delay mechanism</i>	Allows the data exchange mode between module and master, either Peer-to-Peer or End-to-End, to be selected.	End-to-End
<i>Enable client SNTP</i>	Allows the SNTP protocol for distribution of the clock and synchronization signal to be enabled ^(NOTE) .	Off
<i>ANTP Server address</i>	Allows the network server that supplies the SNTP to be set.	0.0.0.0
<i>Time zone</i>	Defines the time zone to be used for synchronism	+00:00
<i>Daylight Saving Time</i>	Used to select whether daylight saving time is present (ON) or not (OFF) in the country to which the synchronization time refers	Off
<i>IEEE 1588 Boundary clock</i>	Parameter useful if an IEEE 1588 GrandMaster clock is not available: <ul style="list-style-type: none"> • If enabled (ON), the module is seen as an IEEE1588 master clock by all the slaves/devices in the same local network, even when the source of external synchronism is different from IEEE 1588 (SNTP for example) • If disabled (OFF) the module benefits from the synchronism of the master in its own network) 	OFF
<i>Enable package Limitation</i>	Enables the Rate limiter function, which limits the number of packages entering the module from the network, to be activated/deactivated	Disable



NOTE: *Enable IEEE 1588 and Enable SNTP client must not be enabled at the same time*

Remote information

Additional information can be accessed via the service connector (via Ekip Connect) or via a system bus communication:

Parameter	Description
<i>HW and Boot version</i>	general module information
<i>Flash CRC status and result</i>	Information about the correctness of the SW in the module
<i>Ekip Link status</i>	Signals Ethernet cable connection errors
<i>SNTP Server Error</i>	Error in communication with SNTP server
<i>SNTP Server Synchronization</i>	State of synchronism with SNTP server
<i>IEEE 1588 status</i>	Valid with Master IEEE 1588= ON , notifies the presence (Slave or PTP Master Active) or absence (PTP Master but Passive) of a higher level master

5 - Ekip Com IEC 61850

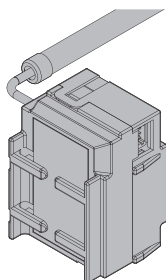

Ekip Com IEC 61850 is a communication accessory which allows Ekip Touch to be integrated into an Ethernet network with IEC 61850 communication protocol, with remote supervision and monitoring functions.

The module is configured as master and remotely, you can:

- read Ekip Touch measurements and information
- manage certain controls, including opening and closing the actuator (MOE-E)
- provide information about the status of the circuit-breaker (open, closed, tripped)
- access information and parameters not available on the display
- transmit vertical communication (report) to superior supervision systems (SCADA), with statuses and measurements (re-transmitted whenever and only if they change with respect to the previous report)
- transmit horizontal communication (GOOSE) to other actuator devices (example: medium voltage circuit-breakers), with all the information about status and measurements normally shared by Ekip Com communication modules via bus.



NOTE: *the remote open and close commands of the circuit-breaker can only be executed if Ekip Touch is in the Remote configuration*

The System Interface document is available for mapping the module in its communication network. All the required communication and command details are listed in the document (page 129).

The document also describes the configuration files for the IEC 61850 protocol and relative uploading procedure for assigning the Technical Name and enabling GOOSE messages (by setting the relative MAC Addresses)

Depending on the parameter settings, described in the next pages, the ports used by the module are:

Ethertype	Port	Protocol
0x0800-IP	102	ISO Transport Service on top of the TCP (RFC 1006)
0x88B8	-	GOOSE Messages
0x0800-IP	123 UDP	NTP - Network Time Protocol
0x0800-IP	69 UDP	TFTP - Trivial File Transfer Protocol



IMPORTANT: **each circuit-breaker can house one module only; configuration with external communication modules is not allowed if an internal module is present.**

Safety and cyber security

Since the module allows the actuator connected to Ekip Touch and access to the data in the unit to be checked, it can only be connected to networks equipped with all the necessary security and prevention measures against unauthorized access (for example, the network of the control system of an installation).



IMPORTANT:

- **it is the customer's sole responsibility to provide and continuously ensure a secure connection between the module and customer network or any other network (as the case may be). The plant manager must establish and maintain appropriate measures (such as but not limited to the installation of firewalls, application of authentication measures, encryption of data, installation of antivirus programs, etc.) to protect the product, the network, the customer system and interface against any kind of security breaches, unauthorized access, interference, intrusion, loss and/or theft of data or information. ABB and its affiliates are not liable for damages and/or losses related to such security breaches, unauthorized accesses, interference, intrusion, loss and/or theft of data or information.**
- **The module cannot be connected directly to the Internet. Only connect to dedicated Ethernet networks with IEC 61850 communication protocol**

Connections To connect the module to its communication network and for references about the terminals, please consult circuit diagrams [1SDM000005A1001](#).

The module is supplied with a 1-meter length cable and cabled RJ45 connector for interfacing with its network.

To connect the module to Ekip Touch and to actuator MOE-E if present, please consult document [1SDH002011A1503](#).

Power supply Ekip Com IEC 61850 is supplied directly by the *Ekip Touch* to which it is connected.



NOTE: communication between *Ekip Touch* and the module is interrupted in the absence of auxiliary power supply

Configurations via menu Local bus activation, which is essential for starting the communication between module and *Ekip Touch*, is available in the *Settings* menu (page 35).

The following communication parameters can be configured if the module has been correctly detected by *Ekip Touch* in the *Settings-Modules* menu:

Parameter	Description	Default
<i>Static IP address ON</i>	Defines whether the module has the dynamic (Off) or static (On) IP address. Se = On all the associated parameters are enabled	Off
<i>Static address IP address</i>	Enables the static IP to be selected	0.0.0.0
<i>Static Network Mask</i>	Enables the subnet mask to be selected	0.0.0.0
<i>Static Gateway address</i>	When there are several subnets, enables the IP address of the node to which the module is connected to be selected	0.0.0.0
<i>Enable SNTP client</i>	Allows the SNTP protocol for distribution of the clock and synchronization signal to be enabled.	Off
<i>SNTP Server Addr.</i>	Allows the network server that supplies the SNTP to be set.	0.0.0.0
<i>Configuration Session</i>	Defines the write mode of the configuration file in the module via the TFTP port; two options are available: <ul style="list-style-type: none"> Always ON: the TFTP port is always open and write is always enabled Activation requested: the TFTP is opened by a specific command, which enables write for a limited time (or for a finite number of data packages) 	Always ON
<i>Start Configuration</i>	Write enable command on TFTP port in Activation mode requested	---

Information in menu The following information will be available in the *About-Modules* menu if *Ekip Touch* has detected the module correctly:

Information	Description
<i>SN and version</i>	Identifier and SW version of the module
<i>IP address</i>	Address of the module, assigned to the module by a DHCP server at the time of connection to the network in the case of configuration with a dynamic IP, or can be set via the menu in the event of a static IP NOTE: without a DHCP server, the module automatically adopts a random IP address within the 169.254.xxx.xxx range
<i>Network Mask</i>	Subnet mask; identifies the method for recognizing the subnet to which the modules belong and enables modules to be searched for within a defined set of recipients.
<i>Gateway address</i>	IP address of the node to which the module is connected, in the presence of several subnets
<i>MAC address</i>	Address assigned by ABB, with OUI (Organizationally Unique Identifier) equal to ac:d3:64, which uniquely identifies the manufacturer of an Ethernet device
<i>Cfg file</i>	Name of the configuration file uploaded to the modules
<i>Cfg file error</i>	Code of the error concerning the configuration file (0 = no error)

Remote configurations

Additional parameters can be accessed via the service connector (via Ekip Connect) or via a system bus communication:

Parameter	Description	Default
<i>Preferred configuration file</i>	If several configuration files are present, allows file hierarchy between .cid and .iid to be defined	.cid
<i>Enable IEEE 1558</i>	Allows the IEEE 1588 protocol for distribution of the clock and synchronization signal to be enabled ⁽¹⁾ .	Off
<i>IEEE 1558 Master</i>	Enables the module to be set up as a master in the the network segment to which it belongs (synchronization clock).	Off
<i>IEEE 1558 Delay mechanism</i>	Allows the data exchange mode between module and master, either Peer-to-Peer or End-to-End, to be selected.	End-to-End
<i>Time zone</i>	Defines the time zone to be used for synchronism	+00:00
<i>Daylight Saving Time</i>	Used to select whether daylight saving time is present (ON) or not (OFF) in the country to which the synchronization time refers	Off
<i>TFTP Security level</i>	Defines the file loading procedure: <ul style="list-style-type: none"> • <i>TFTP always On</i>= port open, loading always possible • <i>TFTP enable required</i>= port normally closed. To start loading, Enable TFTP must be run at the start of the procedure and disable TFTP must be run at the end of the procedure (disable not necessary, security command) 	TFTP always On
<i>CB Open/ CB Close command</i>	Defines the limitations to remote opening and closing command execution: <ul style="list-style-type: none"> • <i>Standard commands</i>= standard commands (unrestricted) activated • <i>CB operate request</i>= standard commands not activated. Use programmable functions YC COMMAND and YO COMMAND, and Request breaker open (28) and Request breaker close (29) commands 	Standard commands
<i>Zone Selectivity Analysis</i>	Analysis of selectivity input from IEC 61850 module can be enabled/ disabled for each of protections S, S2, G, Gext, D, D(BW), D(FW)	Disabled (all)
<i>IEEE 1588 Boundary clock</i>	Parameter useful if an IEEE 1588 GrandMaster clock is not available: <ul style="list-style-type: none"> • If enabled (ON), the module is seen as an IEEE1588 master clock by all the slaves/devices in the same local network, even when the source of external synchronism is different from IEEE 1588 (SNTP for example) • If disabled (OFF) the module benefits from the synchronism of the master in its own network 	OFF
<i>Enable package Limitation</i>	Enables the Rate limiter function, which limits the number of packages entering the module from the network, to be activated/deactivated	Disable

⁽¹⁾ Enable IEEE 1588 and Enable SNTP client must not be enabled at the same time

Remote information

Additional information can be accessed via the service connector (via Ekip Connect) or via a system bus communication:

Information	Description
<i>HW and Boot version</i>	General module information
<i>Flash CRC status and result</i>	Information about the correctness of the SW in the module
<i>Ekip Link status</i>	Signals Ethernet cable connection errors
<i>SNTP Server Error</i>	Error in communication with SNTP server
<i>SNTP Server Synchronization</i>	State of synchronism with SNTP server
<i>IEEE 1558 status</i>	Valid with Master IEEE 1588= ON, notifies the presence (Slave or PTP Master Active) or absence (PTP Master but Passive) of the higher level master
<i>GOOSE Missing</i>	Signals that an expected GOOSE has not been received
<i>Configure Mismatch</i>	A GOOSE received does not conform to the expected structure
<i>Decode Error</i>	
<i>Sequence number error</i>	
<i>Remote programmable statuses (from E to R)</i>	Condition (true/false) of the programmable states and information on selectivity arising from logic defined in the configuration files loaded in module IEC 61850
<i>Zone selectivity remote inputs</i>	

6 - Ekip Link

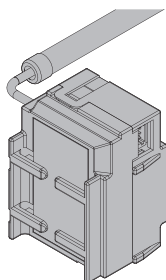

Ekip Link is a communication accessory which allows Ekip Touch to be integrated into an internal Ethernet network with ABB proprietary protocol.

The following functions can be performed with the remote module:

- Programmable Logic
- Zone Selectivity

To perform these functions, the system units involved must be equipped with their own *Ekip Link* and for each of these, the IP addresses of all the other *Ekip Link* connected must have been entered.

Each device is defined as an Actor in the Link network.

Each *Ekip Link* can interface with up to 15 actors, of which up to 12 can be for the Zone Selectivity function.

The ports used by the module are:

Port	Service	Notes
18/UDP	ABB proprietary	In the case of rapid exchanges of information among ABB devices
319/UDP 320/UDP	IEEE 1588	Valid with IEEE 1588 protocol enabled
68/UDP	DHCP client	DHCP client enabled as an alternative to <i>Static address = On</i>

The module also provides information about the status of the circuit-breaker (open, closed, tripped).



IMPORTANT: each circuit-breaker can house one module only; configuration with external communication modules is not allowed if an internal module is present

Connections To connect the module to its communication network and for references about the terminals, please consult circuit diagrams [1SDM000005A1001](#).

The module is supplied with a 1-meter length cable and cabled RJ45 connector for interfacing with its network.

To connect the module to Ekip Touch and to actuator MOE-E if present, please consult document [1SDH002011A1503](#).

Network The *Ekip Link* modules must be connected to a dedicated network that includes only *Ekip Link* and Ethernet switches for which support for level L2 multicast is declared in the datasheet.

If the network also includes other routers, multicast must be enabled and configured in all the level L3 VLAN interfaces

Programmable Logic Activation of up to four bits of the *Ekip Link* can be programmed via the Programmable Logic function, each bit according to any combination of the status bits of an actor of which the IP address has been entered.

These four bits are indicated as Statuses A B C and D; they are remotely programmable and their value is transmitted to the device to which *Ekip Link* is connected

Zone selectivity With the Zone Selectivity function:

- the IP addresses entered refer to actors with the role of interlock with respect to the current role
- the protections for which selectivity must be actuated by setting a mask, must be selected for each interlock actor entered. Thus set, the function will now be indicated as logic in the following text so as to distinguish it from the standard function, now also indicated as hardware in the following text
- thus selected, the protections add to those of the hardware S, G, D-Backward and D-Forward
- hardware selectivity only, or both hardware and logic selectivity can be selected
- diagnosis can be set, for each interlock release, to ascertain whether there is consistency between the hardware and logic selectivity information
- a mask can be set for the purpose of identifying those protections whose received selectivity information must be re-transmitted, regardless of whether the actor is in the alarm status. The mask is only applicable to logic selectivity information

For further details about the Zone Selectivity function with *Ekip Link*, please consult page page 79.

Power supply Ekip Link is supplied directly by the *Ekip Touch* to which it is connected.

NOTE: communication between *Ekip Touch* and the module is interrupted in the absence of auxiliary power supply

Configurations via menu

Local bus activation, which is essential for starting the communication between module and *Ekip Touch*, is available in the *Settings* menu (page 35).

The following communication parameters can be configured if the module has been correctly detected by *Ekip Touch* in the *Settings-Modules* menu:

Parameter	Description	Default
<i>Static IP address ON</i>	Defines whether the module has the dynamic (Off) or static (On) IP address. Se = On all the associated parameters are enabled	Off
<i>Static address IP address</i>	Enables the static IP to be selected	0.0.0.0
<i>Static Network Mask</i>	Enables the subnet mask to be selected	0.0.0.0
<i>Static Gateway address</i>	When there are several subnets, enables the IP address of the node to which the module is connected to be selected	0.0.0.0

Information in menu The following information will be available in the *About-Modules* menu if Ekip Touch has detected the module correctly:

Information	Description
<i>SN and version</i>	Identifier and SW version of the module
<i>IP address</i>	Address of the module, assigned to the module by a DHCP server at the time of connection to the network in the case of configuration with a dynamic IP, or can be set via the menu in the event of a static IP  NOTE: without a DHCP server, the module automatically adopts a random IP address within the 169.254.xxx.xxx range
<i>Network Mask</i>	Subnet mask; identifies the method for recognizing the subnet to which the modules belong and enables modules to be searched for within a defined set of recipients.
<i>Gateway address</i>	IP address of the node to which the module is connected, in the presence of several subnets
<i>MAC address</i>	Address assigned by ABB, with OUI (Organizationally Unique Identifier) equal to ac:d3:64, which uniquely identifies the manufacturer of an Ethernet device

Remote configurations Additional parameters can be accessed via the service connector (via Ekip Connect) or via a system bus communication:

Information	Description	Default
<i>Client/Server</i>	Parameter for changing the configuration of the module from Server Only to Client and Server and for integrating it into an interactive data exchange network (see Ekip Com Hub on page 196).  IMPORTANT: if Client/Server, the module allows data exchange like a normal Server function	Server only
<i>Enable IEEE 1588</i>	Allows the IEEE 1588 protocol for distribution of the clock and synchronization signal to be enabled ⁽¹⁾ .	Off
<i>IEEE 1588 Master</i>	Enables the module to be set up as a master in the the network segment to which it belongs (synchronization clock).	Off
<i>IEEE 1588 Delay mechanism</i>	Allows the data exchange mode between module and master, either Peer-to-Peer or End-to-End, to be selected.	End-to- End
<i>Enable client SNTP</i>	Allows the SNTP protocol for distribution of the clock and synchronization signal to be enabled ⁽¹⁾	Off
<i>ANTP Server address</i>	Allows the network server that supplies the SNTP to be set.	0.0.0.0
<i>Time zone</i>	Defines the time zone to be used for synchronism	+00:00
<i>Daylight Saving Time</i>	Used to select whether daylight saving time is present (ON) or not (OFF) in the country to which the synchronization time refers	Off
<i>Disable Gratuitous ARP</i>	Permits (Enabled ARP) the periodic generation of a Gratuitous ARP message, used by Ekip Connect to rapidly find the modules via Ethernet scan without knowing the IP address beforehand	ARP Enabled
<i>Password protected access</i>	Enables the writing operations performed via the network to be protected by a password (Request password)	Standard mode
<i>Password Modbus TCP</i>	With access protected by enabled password, this is the password to use before each writing session ⁽²⁾ .	Local access

⁽¹⁾ Enable IEEE 1588 and Enable SNTP client must not be enabled at the same time

⁽²⁾ the parameter can only be changed via system bus in the remote configuration

Remote Link configurations Regarding the Link functions, the following further parameters are available:

Information	Description	Default
<i>Link Actor (1÷15)</i>	IP address of each actor (from 1 to 15)	0.0.0.0
<i>Remote Programmable Status (A÷D)</i>	Configuration parameters of the configurable states: <ul style="list-style-type: none"> • selection of actor (actor from 1 to 15) which activates the programmable status • event of the actor that determines change of programmable status 	Actor 1 Nobody
<i>Remote Status word (A÷D)</i>	Configuration parameters of the words: <ul style="list-style-type: none"> • selection of actor (actor from 1 to 15) from which the word status is taken • selection of the taken word 	None 1 global
<i>Diagnostic</i>	Active (Passive diagnosis) or deactivated (No diagnosis) cabled selectivity diagnosis	No Diagnostic
<i>Diagnostic check timeout</i>	30 s, 1 min, 10 min, 60 min diagnosis frequency intervals available, if activated	30 seconds
<i>Zone Selectivity Type</i>	Configuration of hardware selectivity (Only HW) or hardware and logic (Mixed)	HW only
<i>Repeat Configuration mask</i>	Interactive mask for selecting selectivity to be sent also to the upper levels, even if not active in the programmed device	0x0000

Remote information Additional information can be accessed via the service connector (via Ekip Connect) or via a system bus communication:

Information	Description
<i>HW and Boot version</i>	general module information
<i>Flash CRC status and result</i>	Information about the correctness of the SW in the module
<i>Ekip Link status</i>	Signals Ethernet cable connection errors
<i>SNTP Server Error</i>	Error in communication with SNTP server
<i>SNTP Server Synchronization</i>	State of synchronism with SNTP server
<i>IEEE 1558 status</i>	Valid with Master IEEE 1588= ON, notifies the presence (Slave or PTP Master Active) or absence (PTP Master but Passive) of the higher level master

Remote Link information Regarding the Link functions, the following further parameters are available:

Information	Description
<i>Line Congruency detection</i>	Information about the state and inconsistency of HW and logic selectivity (state and type of selectivity inconsistent)
<i>Remote Programmable Status</i>	state (true/false) of remote programmable states A, B, C and D
<i>Remote Status Word</i>	value of remote programmable Words A, B, C, D
<i>Logic Zone Selectivity</i>	Logic selectivity states (inputs and outputs)

7 - Ekip Com Hub

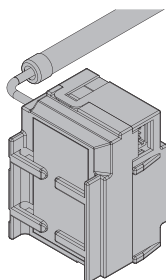

Ekip Com Hub is a communication accessory that enables the data and measurements of Ekip Touch and other devices connected to the same installation to be gathered and then made available on the server through an Ethernet network.

The configuration of the module is available via Ekip Connect or with the System Interface document, which contains all the details. (page 129).

The ports used by the module are:

Port	Service	Notes
67/UDP 68/UDP	DHCP client	DHCP client enabled as an alternative to <i>Static address = On</i>
443/TCP	HTTPS	always active when module is enabled
123/TCP	SNTP	active with SNTP client enabled
53/TCP	DNS	always active

The module also provides information about the status of the circuit-breaker (open, closed, tripped).



IMPORTANT: each circuit-breaker can house one module only; configuration with external communication modules is not allowed if an internal module is present.

Safety and cyber security

The module uses the HTTPS protocol and can be connected to the Internet



IMPORTANT:

- **it is the customer's sole responsibility to provide and continuously ensure a secure connection between the module and customer network or any other network (as the case may be). The plant manager must establish and maintain appropriate measures (such as but not limited to the installation of firewalls, application of authentication measures, encryption of data, installation of antivirus programs, etc.) to protect the product, the network, the customer system and interface against any kind of security breaches, unauthorized access, interference, intrusion, loss and/or theft of data or information. ABB and its affiliates are not liable for damages and/or losses related to such security breaches, unauthorized accesses, interference, intrusion, loss and/or theft of data or information.**

Connections

To connect the module to its communication network and for references about the terminals, please consult circuit diagrams [1SDM000005A1001](#).

The module is supplied with a 1-meter length cable and cabled RJ45 connector for interfacing with its network.

To connect the module to Ekip Touch and to actuator MOE-E if present, please consult document [1SDH002011A1503](#).

Power supply Ekip Com Hub is supplied directly by the *Ekip Touch* to which it is connected.



NOTE: communication between *Ekip Touch* and the module is interrupted in the absence of auxiliary power supply

Configurations via menu Local bus activation, which is essential for starting the communication between module and *Ekip Touch*, is available in the *Settings* menu (page 35).

The following communication parameters can be configured if the module has been correctly detected by *Ekip Touch* in the *Settings-Modules* menu:

Parameter	Description	Default
<i>Enable</i>	Switches communication between module and server on/off.	Off
<i>Static IP address ON</i>	Defines whether the module has the dynamic (Off) or static (On) IP address. If = On all the associated parameters are enabled	Off
<i>Static address IP address</i>	Enables the static IP to be selected	0.0.0.0
<i>Static Network Mask</i>	Enables the subnet mask to be selected	0.0.0.0
<i>Static Gateway address</i>	When there are several subnets, enables the IP address of the node to which the module is connected to be selected	0.0.0.0
<i>Enable SNTP client</i>	Allows the SNTP protocol for distribution of the clock and synchronization signal to be enabled.	Off
<i>SNTP Server Addr.</i>	Allows the network server that supplies the SNTP to be set.	0.0.0.0
<i>Password</i>	code required to register module on Cloud	---

The Remote FW update submenu enables the Firmware update function of the module to be managed; the following parameters are available:

Parameter	Description	Default
<i>Enable</i>	Enables firmware update function of module to be remotely activated/deactivated	OFF
<i>Automatic</i>	The parameter is available when Enable = On and allows the automatic update mode to be activated (On): in the presence of new Firmware, this latter is updated automatically. If the parameter is Off, updating must be performed in the Manual mode: in the presence of new Firmware, the message Ekip Com Hub FW Update appears in the status bar and updating is performed via the Manual command	OFF (manual)
<i>Start FW update</i>	This parameter is available when Enable= On, with Automatic= Off configuration and when new Firmware is present (see description above); allows the Firmware update of the module to run	Little endian

Information in menu The following information will be available in the *About-Modules* menu if Ekip Touch has detected the module correctly:

Information	Description
<i>SN and version</i>	Identifier and SW version of the module
<i>IP address</i>	Address of the module, assigned to the module by a DHCP server at the time of connection to the network in the case of configuration with a dynamic IP, or can be set via the menu in the event of a static IP i NOTE: <i>without a DHCP server, the module automatically adopts a random IP address within the 169.254.xxx.xxx range</i>
<i>Network Mask</i>	Subnet mask; identifies the method for recognizing the subnet to which the modules belong and enables modules to be searched for within a defined set of recipients.
<i>Gateway address</i>	IP address of the node to which the module is connected, in the presence of several subnets
<i>MAC address</i>	Address assigned by ABB, with OUI (Organizationally Unique Identifier) equal to ac:d3:64, which uniquely identifies the manufacturer of an Ethernet device

Remote configurations Additional parameters can be accessed via the service connector (via Ekip Connect) or via a system bus communication:

Information	Description	Default
<i>CRL Enable</i>	Allows the CRL (Certificate Revocation List) to be used to ascertain whether the server certificate is valid	
<i>Clock update hardening enable</i>	Enables control of the time reference transmitted by the SNTP server	
<i>SNTP Server Location</i>	Enables the position of the SNTP server to be set in relation to the network in which the module is installed	
<i>SNTP Time zone</i>	Defines the time zone to be used for synchronism	+00:00
<i>SNTP Daylight Saving Time</i>	Used to select whether daylight saving time is present (ON) or not (OFF) in the country to which the synchronization time refers	OFF
<i>Disable Gratuitous ARP</i>	Permits (Enabled ARP) the periodic generation of a Gratuitous ARP message, used by Ekip Connect to rapidly find the modules via Ethernet scan without knowing the IP address beforehand	ARP Enabled
<i>Cloud data send enable</i>	Enables/disables the function that collects and transmits the module data	OFF
<i>JSON data compression</i>	Allows the compressed format of the JSON file sent to Cloud to be selected (enable)	Disabled

Remote information

Additional information can be accessed via the service connector (via Ekip Connect) or via a system bus communication:

Information	Description
<i>HW and Boot version</i>	General module information
<i>Flash CRC status and result</i>	Information about the correctness of the SW in the module
<i>Publish enable configuration</i>	Enable status in <i>Security File</i>
<i>Configuration file</i>	Name of the file dedicated to the information to transmit (measurements, etc.)
<i>Security file</i>	Name of the file dedicated to the information requested by the module for transmission purposes (addresses, certificates, etc.)
<i>Certificate Revocation List</i>	Name of the file containing the revoked certificates
<i>Executable file</i>	Name of the executable firmware update file
<i>Configuration error</i>	Module configuration error state
<i>Sample time</i>	Period of data acquisition from the connected devices
<i>Log time</i>	Period within which the acquired data are saved in the log
<i>Upload time</i>	Period (calculated by the module) between each data transmission
<i>Configured device</i>	Number of modules involved in the network with Hub module
<i>Polling period API events</i>	Period in which the module communicates with the API device
<i>Connection client 1, 2, 3</i>	Address of TCP Modbus clients connected to the module
<i>Statistics</i>	Recordings of the latest saving operations and percentage of resources being used
<i>Status plant side</i>	Information about the quality of the communication with the other devices
<i>Status Cloud side</i>	State of the errors concerning the TLS session established between module and server
<i>Application status</i>	Operation progress indicators
<i>Status</i>	General indicators of the module: SNTP state, flash, cable connection, FW availability, file errors, etc.

8 - Ekip Signalling 1K

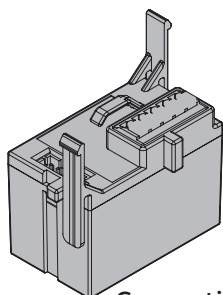

Connections

Ekip Signalling 1K is a signaling accessory allowing programmable inputs/outputs to be managed. The module can be configured in the CB with the IEC standard.



IMPORTANT: each circuit-breaker can house one module only; configuration with external modules is not allowed if an internal module is present

The circuit diagrams and references concerning the terminals are available in document [1SDM000005A1001](#). To connect the module to Ekip Touch and to actuator MOE-E if present, please consult document [1SDH002011A1507](#).

Power supply

Ekip Signalling 1K is supplied directly by the Ekip Touch to which it is connected.



WARNING! communication between Ekip Touch and the module is interrupted in the absence of auxiliary power supply

Input

The input can be configured so that its status corresponds to actions or signals, with different programming options (see *Menu*).

The module permits two logic statuses, interpreted differently by the Trip unit on the basis of the selected configuration:

State	Electrical condition	Contact configuration	Status detected by Trip unit
Open	Circuit open ⁽¹⁾	Active open	ON
		Active closed	OFF
Close	Short-circuit ⁽²⁾	Active open	OFF
		Active closed	ON

⁽¹⁾ $R > 100 \text{ k}\Omega$

⁽²⁾ $R (\text{wiring} + \text{short circuit contact}) < 25 \Omega$

Output

The output has three contacts: normally open (NO), normally closed (NC) and common.

The output can be configured so that the contacts change status when one or more events occur, with different programming options (see *Menu*).

Compared to the common contact, the NO and NC contacts have the following electrical characteristics:

Characteristics	Maximum limit ⁽¹⁾
Maximum switchable voltage	150 VDC / 250 VAC.
Breaking capacity	2 A @ 30 VDC, 0,8 A @ 50 VDC, 0,2 A @ 150 VDC, 4 A @ 250 VAC
Dielectric strength between contact and internal coil	1000 V AC (1 minute @ 50 Hz).

⁽¹⁾ data relating to a resistive load

Input parameters The input can be configured in the *Settings-Modules-Ekip Signalling 1K-Input* menu:

Parameter	Description	Default
<i>Polarity</i>	Defines whether the input is interpreted as ON by the Trip unit when it is open (<i>Active open</i>) or when it is closed (<i>Active Closed</i>)	Active closed
<i>Delay</i>	Minimum activation time of the input before status change is recognized; the delay is given in seconds and can be set within range: 0 s to 100 s, in 0.01 s steps i NOTES : <ul style="list-style-type: none"> • <i>status change is not recognized if the input deactivates before this time has elapsed</i> • <i>if delay = 0 s status change must still be more than 300 μS</i> 	0.1 s

Output parameters The output can be configured in the *Settings-Modules-Ekip Signalling 1K-Output* menu:

Parameter	Description	Default
<i>Signal source</i>	Event which activates the output and switches the contacts. Different protection proposals, statuses and thresholds are available on the display; the Custom mode can be configured via Ekip Connect so as to extend the solutions and combine several events	None
<i>Delay</i>	Minimum duration of the presence of the source before the output is activated; the delay is given in seconds and can be set within range: 0 s to 100 s, in 0.01 s steps i NOTE: <ul style="list-style-type: none"> • <i>the output will not be switched if the source is deactivated before this time has elapsed</i> • <i>if delay = 0 s the source must still be present for longer than 300 μS</i> 	0 s
<i>Contact Type</i>	Defines the rest status of the contact with source not present between: open (NO) and closed (NC)	NO
<i>Latched</i>	Allows the output (and relative status led) to be kept activated (On) or deactivated (Off) when the event disappears	Off
<i>min Activation Time</i>	Defines the minimum closing time of the contact following the rapid presence of sources <ul style="list-style-type: none"> • <i>Source duration < min. activation = contact is activated for the minimum activation time</i> • <i>Source duration \geq min. activation = contact is activated for as long as the source persists</i> Choose between: 0 ms, 100 ms, 200 ms	0 ms

About The *About-Modules* menu contains the specific menu of the module, in which the statuses of the input (*On/Off*) and output (*Open/Closed*) are present.

Test The output test command can be executed in the *Test* menu (see page 125).

9 - Ekip Maintenance

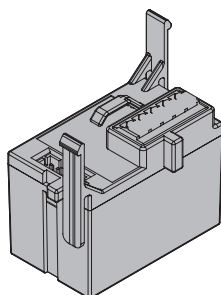

Ekip Maintenance is a signaling accessory allowing a programmable input and a programmable output to be managed.

The module can be configured in the CB according to standard UL; the menus and information about the module are available in the Trip unit with the names of the respective module for the IEC standard (*Ekip Signalling 1K*).



IMPORTANT: each circuit-breaker can house one module only; configuration with external modules is not allowed if an internal module is present

Connections The circuit diagrams and references concerning the terminals are available in document [1SDM000005A1001](#). To connect the module to Ekip Touch and to actuator MOE-E if present, please consult document [1SDH002011A1507](#).

Power supply *Ekip Maintenance* is supplied directly by the Ekip Touch to which it is connected.

 **NOTE:** communication between Ekip Touch and the module is interrupted in the absence of auxiliary power supply

Input The input can be configured so that its status corresponds to actions or signals, with different programming options (see *Menu*).

The module permits two logic statuses, interpreted differently by the Trip unit on the basis of the selected configuration:

Parameter	Description	Contact configuration	Status detected by Trip unit
Open	Circuit open ⁽¹⁾	Active open	ON
		Active closed	OFF
Close	Short-circuit ⁽²⁾	Active open	OFF
		Active closed	ON

⁽¹⁾ $R > 100 \text{ k}\Omega$

⁽²⁾ $R \text{ (wiring + short circuit contact)} < 25 \text{ }\Omega$

Output The output has three contacts: normally open (NO), normally closed (NC) and common. The output can be configured so that the contacts change status when one or more events occur, with different programming options (see *Menu*).

Compared to the common contact, the NO and NC contacts have the following electrical characteristics:

Characteristics	Maximum limit ⁽¹⁾
Maximum switchable voltage	150 VDC / 250 VAC.
Breaking capacity	2 A @ 30 VDC, 0,8 A @ 50 VDC, 0,2 A @ 150 VDC, 4 A @ 250 VAC
Dielectric strength between contact and internal coil	1000 V AC (1 minute @ 50 Hz).

⁽¹⁾ data relating to a resistive load

Input parameters The input can be configured in the *Settings-Modules-Ekip Signalling 1K-Input* menu:

Parameter	Description	Default
<i>Polarity</i>	Defines whether the input is interpreted as ON by the Trip unit when it is open (<i>Active open</i>) or when it is closed (<i>Active Closed</i>)	Active closed
<i>Delay</i>	Minimum activation time of the input before status change is recognized; the delay is given in seconds and can be set within range: 0 s to 100 s, in 0.01 s steps i NOTES: <ul style="list-style-type: none"> • <i>status change is not recognized if the input deactivates before this time has elapsed</i> • <i>if delay = 0 s status change must still be more than 300 μS</i> 	0.1 s

Output parameters The output can be configured in the *Settings-Modules-Ekip Signalling 1K-Output* menu:

Parameter	Description	Default
<i>Signal source</i>	Event which activates the output and switches the contacts. Different protection proposals, statuses and thresholds are available on the display; the Custom mode can be configured via Ekip Connect so as to extend the solutions and combine several events	None
<i>Delay</i>	Minimum duration of the presence of the source before the output is activated; the delay is given in seconds and can be set within range: 0 s to 100 s, in 0.01 s steps i NOTES: <ul style="list-style-type: none"> • <i>the output will not be switched if the source is deactivated before this time has elapsed</i> • <i>if delay = 0 s the source must still be present for longer than 300 μS</i> 	0 s
<i>Contact Type</i>	Defines the rest status of the contact with source not present between: open (NO) and closed (NC)	NO
<i>Latched⁽¹⁾</i>	Allows the output (and relative status led) to be kept activated (On) or deactivated (Off) when the event disappears	Off
<i>min Activation Time⁽²⁾</i>	Defines the minimum closing time of the contact following the rapid presence of sources: <ul style="list-style-type: none"> • <i>Source duration < min. activation = contact is activated for the minimum activation time</i> • <i>Source duration \geq min. activation = contact is activated for as long as the source persists</i> Choose between: 0 ms, 100 ms, 200 ms	0 ms

⁽¹⁾ deactivate the latching of the outputs used if the Measurement module is used for the Power Controller function

⁽²⁾ if Measurement module is used for the Power Controller function, the Pulse Mode option will also be available; if selected, the output is kept activated for a set time that depends on the function, regardless of whether the event that activated it persists

About The *About-Modules* menu contains the specific menu of the module, in which the statuses of the input (*On/Off*) and output (*Open/Closed*) are present.

Test The output test command can be executed in the *Test* menu (page 125).

10 - Micro I/O

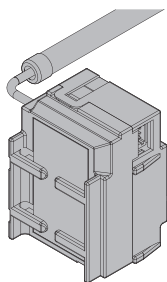

Micro I/O is a signaling accessory which provides the Trip unit with information about the status of the circuit-breaker (open, closed, tripped).

Micro I/O is configured by default and is available for XT5 circuit-breakers without internal modules installed.

Connections The circuit diagrams and references concerning the terminals are available in document [1SDM000005A1001](#). To connect the module to Ekip Touch and to actuator MOE-E if present, please consult document [1SDH002011A1509](#).

Other electronic accessories

1 - Ekip Signalling 10K

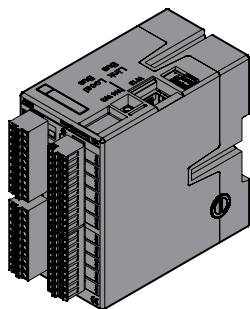

Ekip Signalling 10K is an external accessory signaling module. It can be installed on a standard 35 mm DIN rail (DIN EN 50022 type TS 35x15 mm).

This module has:

- Ten programmable output contacts
- Ten or eleven programmable digital inputs
- One power led and twenty or twenty-one signaling leds (one for each input/output)

The module can be set in four different configurations

- One in case of connection to a Link bus network
- Three configurations in case of connection via Local Bus (to allow up to three modules to be connected to the same trip unit)

The module can be supplied by 110...240 V AC / DC or 24...48 V DC.

Further details about *Ekip Signalling 10K* are available in ABB Library, especially in document [1SDH001318R0002](#).



IMPORTANT: make sure that you have read the recommendations concerning safety and prevention of unauthorized access.

2 - Ekip Signalling Modbus TCP

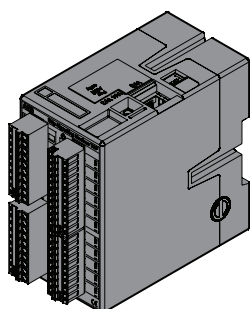

Ekip Signalling Modbus TCP is an external accessory module. It can be installed on a standard 35 mm DIN rail (DIN EN 50022 type TS 35 x 15 mm).

Its function is to share on another Ethernet network with communication protocol.

The module has 11 digital inputs and 10 output contacts:

- The inputs allow the state of the devices and other information to be monitored
- The outputs allow the circuit-breakers to be operated.

Each input and output is associated with a state LED.

The module can operate in three modes:

Mode	Characteristics
CB Supervisor	The module can be associated with a single circuit-breaker, which can be selected from a list. Configuration of the inputs and output is pre-defined
Multi MCCB Supervisor	The module can be associated with up to five circuit-breakers. Configuration of the inputs and output is pre-defined.  NOTE: mode available with moulded-case circuit-breakers
Free I/O	The inputs and outputs can be fully configured by the user

The module can be supplied by 110...240 V AC / DC or 24...48 V DC.

Further details about *Ekip Signalling Modbus TCP* are available in ABB Library, especially in document [1SDH001456R0002](#).

3 - Ekip Multimeter

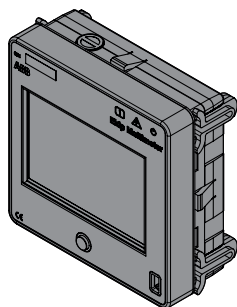

Ekip Multimeter is a remote display panel-front module with touchscreen display allowing the parameters of the Trip unit to which it is connected via local bus to be displayed and edited.

Up to four *Ekip Multimeter* modules can be connected to the same Trip unit. On the other hand, the module can only be connected to one Trip unit.

The rear connector allows the unit to be supplied in two different ways:

Terminals / supply voltage	Frequency	Power input	Inrush current
21,5 ÷ 53 VDC	-	Maximum 10W	Maximum 2 A for 20 ms
105 ÷ 265 VAC/DC	45 ÷ 66 Hz	Maximum 10 VA/W	Maximum 2 A for 20 ms



IMPORTANT: AC and DC supplies cannot be present at the same time

The module provides for 24 VDC auxiliary voltage (terminals 24 Vout L+ and L-), which can be used to directly supply the Trip unit.



WARNING! Ekip Multimeter is sized to supply the Trip unit alone, without additional modules: if auxiliary voltage is used via module, it must be connected directly to the terminal box of the CB without the possibility of using Ekip Supply or other modules

Connections

Belden 3105A cables or equivalent, up to 15 m in length, must be used for the local bus and auxiliary supply. The cable shield must be earthed on both sides of the connection.

Documents

Further details are available in ABB Library, especially in document [1SDH001000R0520](#).

4 - External neutral

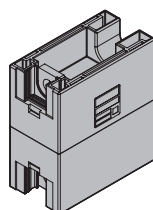

This is a current sensor for the external neutral pole of the circuit-breaker, designed for 3P CBs. It provides neutral protection via the connection to the Trip unit.

The sensor is available in two versions: one version allows solely the sensor to be connected to the trip unit; the other version has a connection for neutral voltage (V0).

To configure the presence of the sensor and protection, please consult pages 35 and 49.

Further details about the *External neutral* connection are available in ABB Library, especially in document [1SDH001000R0506](#).

5 - Testing and Programming

Ekip TT

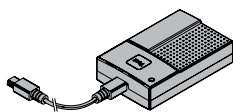

Ekip TT is a supply accessory and is useful for powering Ekip Touch in the absence of auxiliary power supply; the unit allows:

- Ekip Touch to be supplied and the tripped protection to be displayed, in the event of a TRIP and absence of auxiliary voltage
- the protections and certain parameters to be set before installation in the system



IMPORTANT:

- **Ekip TT can also be connected to Ekip Touch when in service.**
- **Ekip TT only supplies the Trip unit: the presence of an auxiliary supply is required in order to set and display the information about the electronic accessories**

Ekip TT is connected to the service connector of Ekip Touch by means of the supplied cable.

To switch on the module, set the side switch to the ON position and check the status of the led:

- if green, proceed with the required reading and configuring operations
- if red, replace the batteries of the device (three 1.5 V AA batteries)

Further details are available in ABB Library, especially in document [1SDH001000R0519](#)

Ekip Programming and Ekip T&P

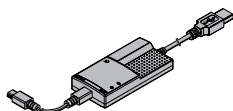

Ekip Programming is a supply and communication accessory that is useful for:

- Ekip Touch to be supplied and the tripped protection to be displayed, in the event of a TRIP and absence of auxiliary voltage
- the protections and certain parameters to be set before installation in the system
- with Ekip Connect software, accessing the programming, measuring pages and other exclusive functions (Datalogger, Dataviewer, IEC 61850)



IMPORTANT:

- **Ekip Programming can also be connected to Ekip Touch when in service**
- **Ekip Programming only supplies the Trip unit: the presence of an auxiliary supply is required in order to set and display the information about the electronic accessories**

Ekip Programming connects to the USB port of the PC, from which it receives the power required to switch on and also supply Ekip Touch; connection to the service connector of Ekip Touch must be made with the supplied cable.

Ekip Programming has two leds, one green to indicate when the module is on, the other yellow to indicate when communication is activated.

Ekip T&P is a supply and communication accessory with the same characteristics as *Ekip Programming*, plus a further function:

- with Ekip Connect software, it enables access to the test pages



We reserve the right to make technical changes or modify the contents of this document without prior notice. ABB does not accept any responsibility whatsoever for potential errors or possible lack of information in this document.

We reserve all rights in this document and in the subject matter and illustrations contained therein. Any reproduction, disclosure to third parties or utilization of its contents – in whole or in parts – is forbidden without prior written consent of ABB.

Copyright© 2022 ABB - All rights reserved.