

SPIROTECH SPECIFICATION SHEET



MultiControlKompact 200 solo-4.0

Customer:

Project:

Reference:

Type: **EMCK-S200-4.0**

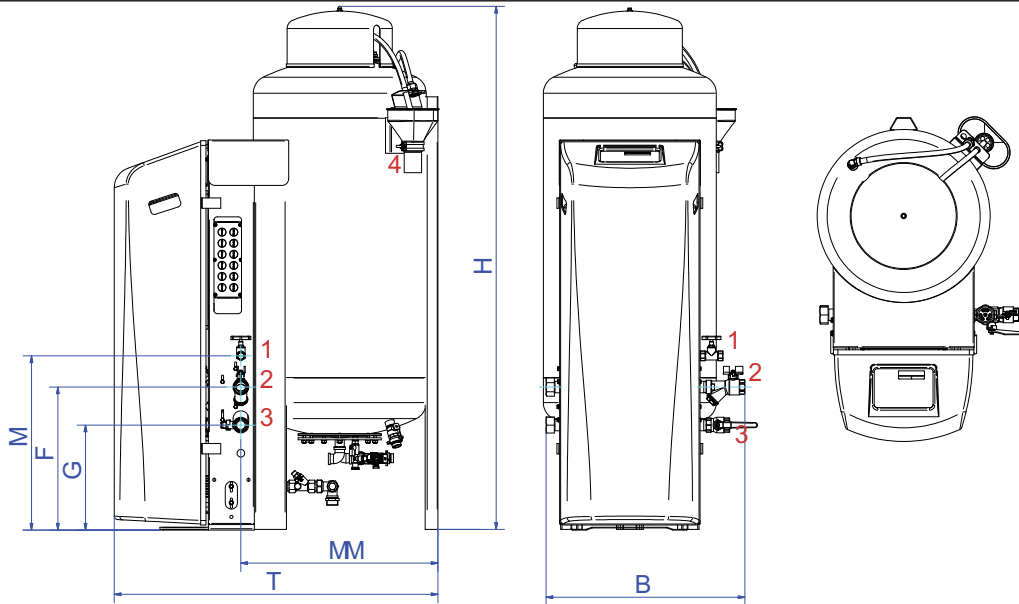

Design criteria

Medium:	Water / glycol (max 40%)
Min. Pressure:	1.0 bar-g
Discharge:	4.0 bar-g
Max. pressure:	10.0 bar-g
Max. temperature:	70 °C
Ambient temperature:	0 - 40 °C
Refill fluid:	0 - 70 °C

Testing and quality assurance

Running test:	yes
Test medium:	Water
High voltage test:	yes
Test certificate:	no
CE-marking:	yes
Material certificates:	no

Construction materials

Fittings / pipes:	Copper/Brass
Pump:	AISI316
Main pump:	Horizontal multistage 1 x 100%
Overflow valve(s)	1 x 100%
Casing:	Galvanised steel plate
Color:	Yellow (RAL 1003)

Power supply

Voltage:	[1x] 230V~/50Hz
Power consumption:	0.6 kW
Protection level:	IPX4D

Dimensions

Height:	1512 mm
Width:	575 mm
Depth:	936 mm
B	575 mm
F	413 mm
G	303 mm
H	1512 mm
M	503 mm
MM	570 mm
T	936 mm

Dry weight (approx): 115 kg

Connections

1. Refill	Rp1/2
2. Exp. overflow pipe	Rp1
3. Exp. pressure pipe	Rp1
4. Discharge	DN50 Geberit

Subject to changes