

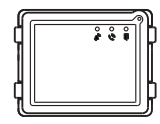

Modulübersicht

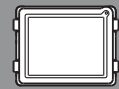

Audiomodul

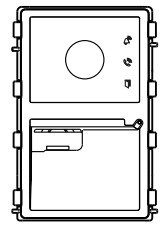

Audio/Video Modul 130

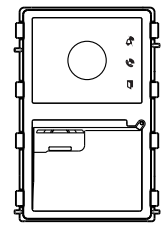

Audio/Video Modul 180

Welcome

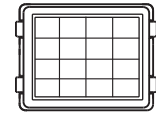

Tastatur-Modul

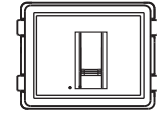

Fingerprint-Modul

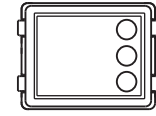

Tastenmodul 1-3 fach

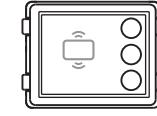

Tastenmodul 1-3 fach RFID

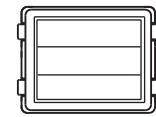

Tastenmodule 3/6

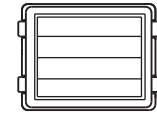

Tastenmodule 4/8

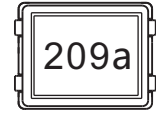

Infomodul

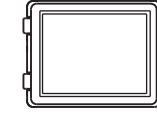

Blindmodul

Welcome & Welcome IP

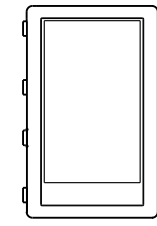

Touch 5-Modul

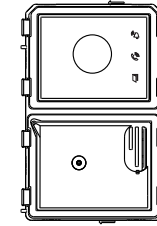

Audio/Video modul

Welcome IP

Frontplatten Audio (Einheit: mm)

Welcome

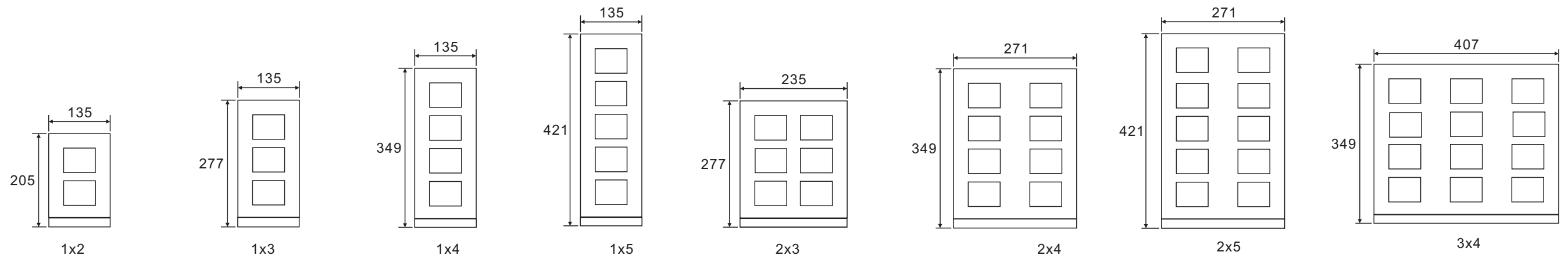

Frontplatten Video (Einheit: mm)

Welcome & Welcome IP

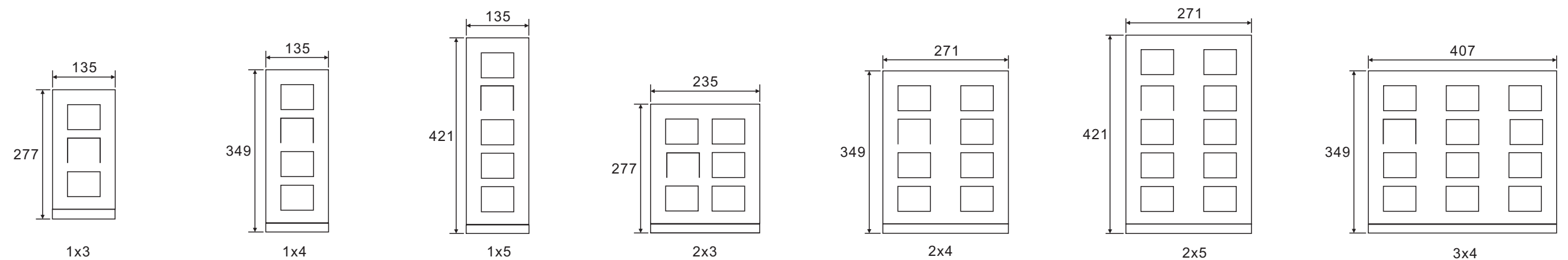

Aufputz-Montagedosen (Einheit: mm)

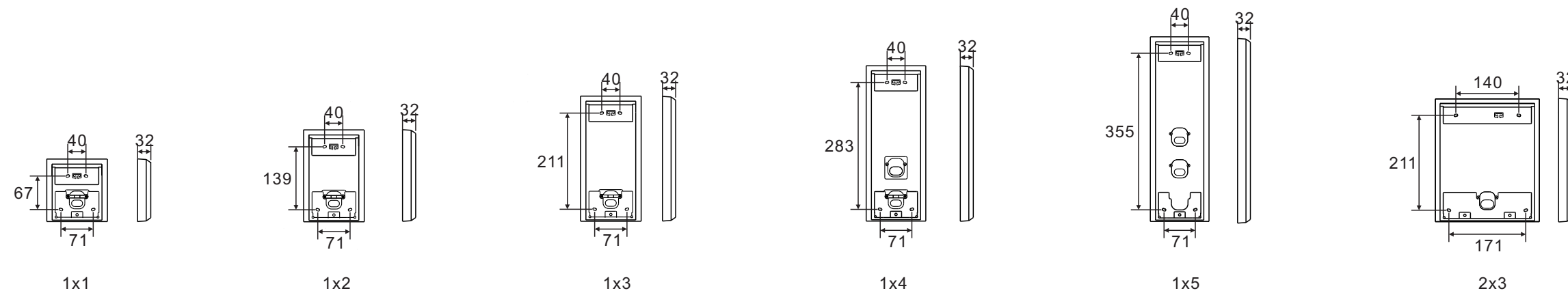

Unterputz-Montagedosen (Einheit: mm)

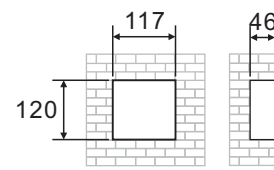
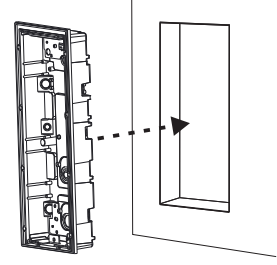

1x1

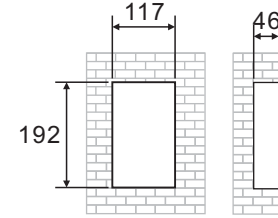

1x2

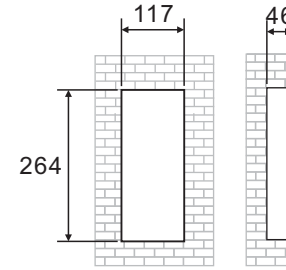

1x3

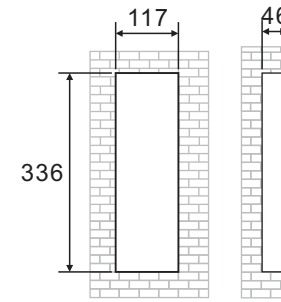

1x4

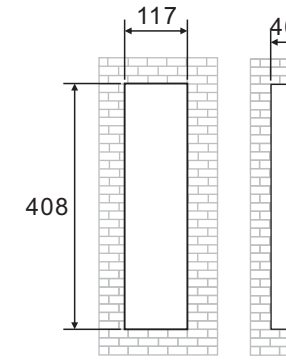

1x5

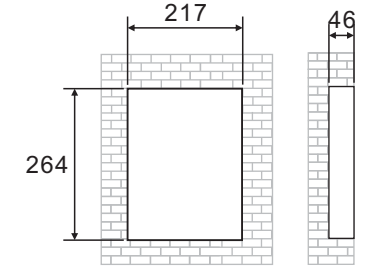

2x3

Einputzdosen (Einheit: mm)

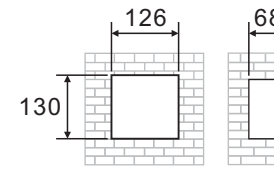
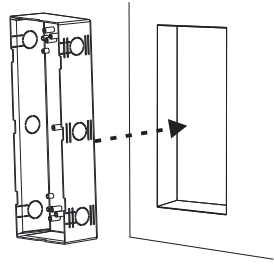

1x1

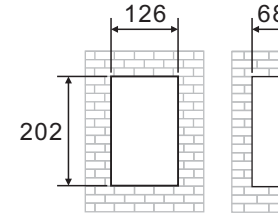

1x2

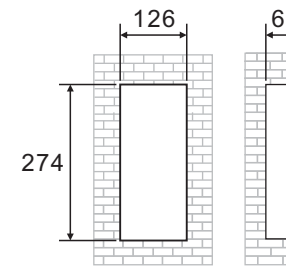

1x3

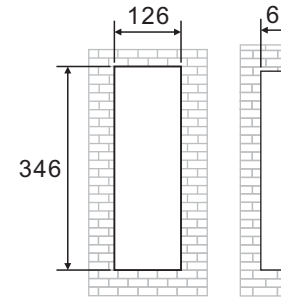

1x4

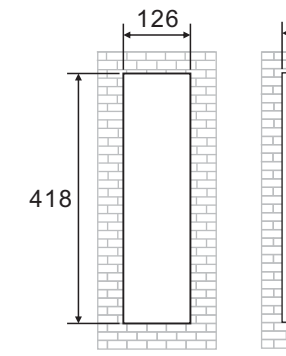

1x5

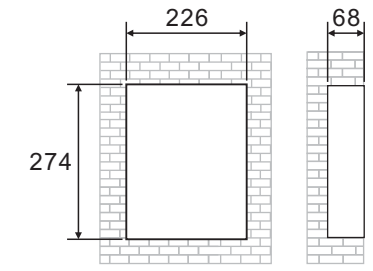

2x3

Vorbereitung

Benutzen Sie Handschuhe zum Schutz vor Schnittverletzungen.

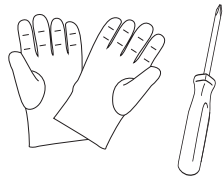

Montage und Verkabelung der Module

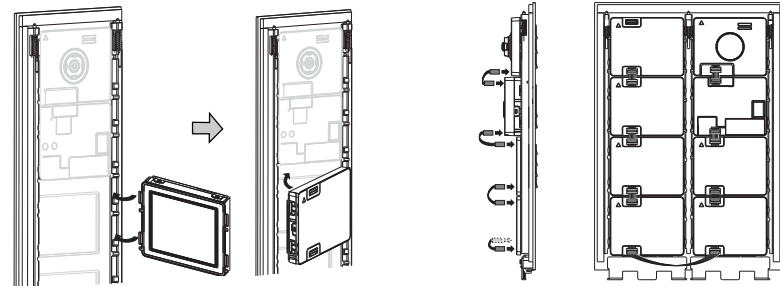

Installationshöhe

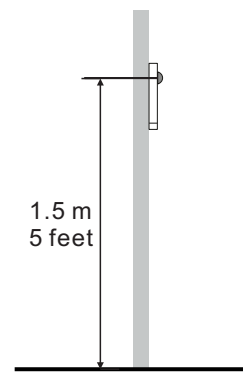

mm x mm

