

Efficient, flexible and simple signaling



Eaton's signal towers are devices that use light and sound to indicate the operating states of machines, systems and processes. They come in three types: the modular SL4 and SL7, and the non-modular compact SLC. The SL4/SL7 modular types can be customized with different coloured LED lights and acoustic modules, while the SLC compact type has three fixed colours and optional acoustic modules. Eaton's signal towers are versatile, reliable, easy to install and configure for various applications.



Powering Business Worldwide

Features

Efficient

Eaton's stack lights offer all the features you will need for easy and clear system status identification.

Six colors for the international market: red, yellow, green, blue, clear and orange (amber).

Lighting variants: continuous illumination light, flashing light, strobe light, variable strobe light.

Acoustic modules with up to 8 different signals and adjustable volume levels for optimal adaptation to any ambient condition.

LED and high performance LEDs for better brightness.

Communication: The SL7 portfolio supports all current AS-i versions and SmartWire-DT connection for easy integration of SL7 signal towers.

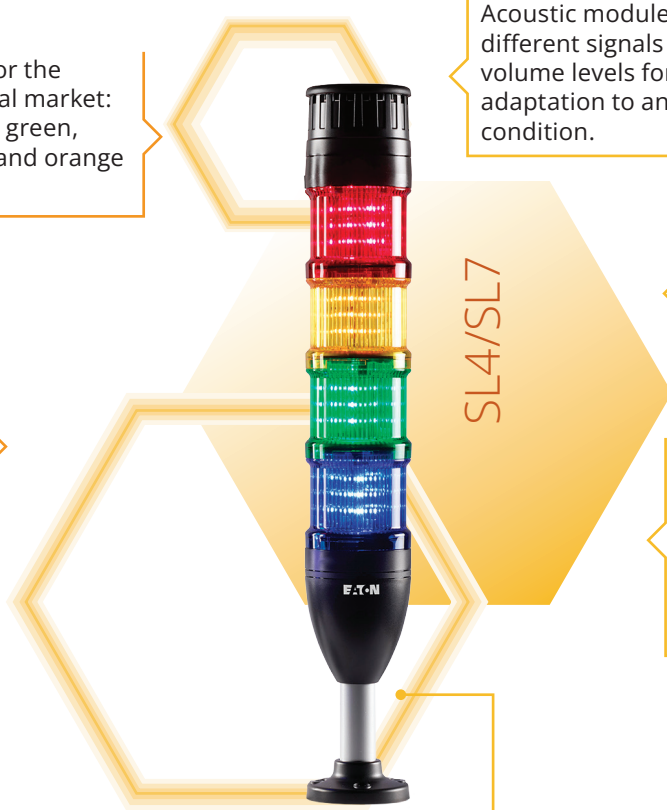

IP66 rating for protection against dust and water.

UV protected plastic material

Red blinking light

3 colors red yellow and green

>70db acoustic tone module, pulse tone _ _ _



Features

Three different sized products

Eaton's signal towers come in 3 different sizes giving you the option to choose the correct device for your needs, based on factors such as space, visibility, sound and functionality.



Sound modules

The optional acoustic modules (up to 100db) are an easy but powerful way to hear if the application requires immediate attention



Bright LEDs

The SL4/SL7 6 coloured LEDs light modules can be stacked on top of each other, in the quantity (up to 5) and order of your choice, to clearly visually indicate the status of the machines, processes or systems: such as ready, busy, error, emergency, or maintenance.

The SLC's simple and intuitive three colors of red, yellow, and green are universally recognized as stop, caution, and go signals. They do not require any special training or interpretation to understand the meaning of each light.



 Precise classification of information thanks to six colors

Features

Many base modules

SL4/SL7

There are up to 11 base modules giving you the flexibility to select a base module that can be mounted on the location and the orientation of your choice.



SLC

There are 3 variants available: standard base module, wall mounted and hole mounting.



Quick mounting

The rapid mounting and wiring system with bayonet fitting means that the electrical wiring only needs to be connected once, with the lower portion simply remaining on the machine. If the machine needs to be transported to another location, the signal tower can be remounted immediately and effortlessly.

The complete stacklight can be easily assembled with a simple twist



SL4/SL7



Transport cover for cables and connections protection

SLC

The hole mounting SLC variant, using the standard 22mm hole, is fitted with an M12 plug for quick installation.



Features

Customizable

With our online configurator, you can customize your SL4 and SL7 stack lights to fit your requirements. You can select the different types of lights and mounting modules. You will see a realistic preview of how your signal towers will look. The tool also creates a list of items that you can send directly to Eaton or your preferred distributor.

Visit www.eaton.com/config/signaltower

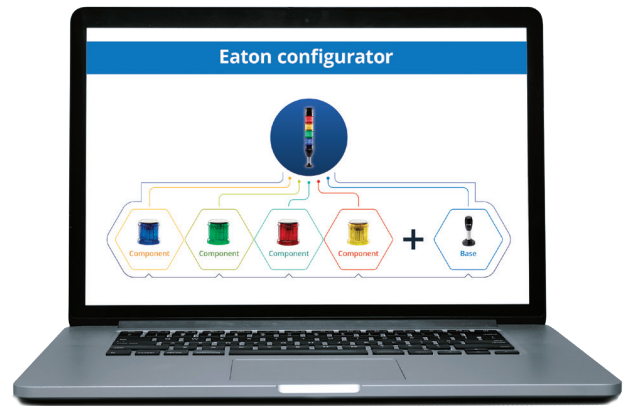

Technical data

	SL4	SL7	SLC
Voltage	24V, 120V and 230 V	24V, 120V and 230 V	24V, 120V and 230 V
IP Protection	IEC IP66, UL Type 4, 4X, 13	IEC IP66, UL Type 4, 4X, 13	IEC IP66, UL Type 4, 4X, 13
Standards	IEC/EN 60947-5-1, UL	IEC/EN 60947-5-1, UL	IEC/EN 60947-5-1, UL
Ambient temperature	-30 ...+60° C	-30 ...+60° C	-25 ...+50° C
Lights			
Light module diameter	43 mm	73 mm	61 mm
Type of lights	Continuous, flashing, strobe	Continuous, flashing, strobe and high performance which is superbright	Continuous, flashing, strobe
Customisable	Yes	Yes	No
Light colours	Red, yellow, green, blue, clear and orange (amber)	Red, yellow, green, blue, clear and orange (amber)	Red, yellow, green
Acoustic			
Optional acoustic module	Yes	Yes	Yes
Acoustic level	80 dB	100 dB	70 dB
Type of tones	Continuous or pulse	Continuous, pulse and multi-tone (8 tones)	Pulse tone
Mounting options			
Number of mounting options	10	11	3
Terminals	<ul style="list-style-type: none"> • Push-in terminals 	<ul style="list-style-type: none"> • 5-pole M12 plug-in • Spring cage terminals • Push-in terminals 	<ul style="list-style-type: none"> • 5-pole M12 plug-in • Push-in terminals
Base height	100, 250, 400, 800 mm	100, 250, 400, 800 mm	100 mm

SLC Stack Light Compact range overview

	Rated operational voltage	Module without acoustic		Module with acoustic pulse tone -----	
		Part no. Article no.	Light status icons	Part no. Article no.	Light status icons
Complete devices with standard base					
	24 VDC	SLC-100-RYG-24 EP-400208		SLC-100-RYG-AP-24 EP-400211	
	24 VUC*	SLC-100-RYG-24UC EP-400194		SLC-100-RYG-AP-24UC EP-400197	
	120 VAC	SLC-100-RYG-120 EP-400200		SLC-100-RYG-AP-120 EP-400202	
	230 VAC	SLC-100-RYG-230 EP-400214		SLC-100-RYG-AP-230 EP-400216	
Complete devices with M22 hole mounting and M12 plug					
	24 VDC	SLC-M22-RYG-24 EP-400210		SLC-M22-RYG-AP-24 EP-400213	
	24 VUC*	SLC-M22-RYG-24UC EP-400196		SLC-M22-RYG-AP-24UC EP-400199	
Complete devices with wall base					
	24 VDC	SLC-FW-RYG-24 EP-400209		SLC-FW-RYG-AP-24 EP-400212	
	24 VUC*	SLC-FW-RYG-24UC EP-400195		SLC-FW-RYG-AP-24 EP-400198	
	120 VAC	SLC-FW-RYG-120 EP-400201		SLC-FW-RYG-AP-120 EP-400203	
	230 VAC	SLC-FW-RYG-230 EP-400215		SLC-FW-RYG-AP-230 EP-400217	

* UC = universal current (AC/DC)

Dimensions

Standard base SLC-100-RYG

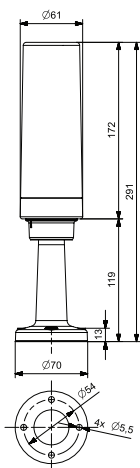

M22 hole mounting SLC-M22-RYG

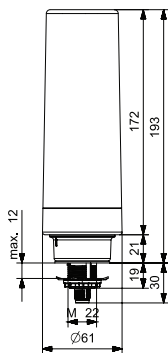

Wall mounting SLC-FW-RYG

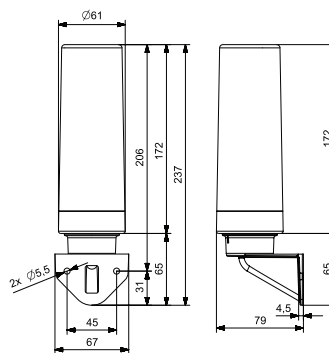

SL4 and SL7 Complete devices and base modules

Rated operational voltage U _o V	Number of modules	Color	Module diameter 70 mm	Module diameter 40 mm
			Part no. Article no.	Part no. Article no.

Complete devices (IP66)

Complete Units



24 V AC/DC

2		SL7-100-L-RG-24LED 171424	SL4-100-L-RG-24LED 171295
3		SL7-100-L-RYG-24LED 171425	SL4-100-L-RYG-24LED 171296
3		SL7-100-L-RAG-24LED 173982	SL4-100-L-RAG-24LED 173981

Customized complete devices

Connection to signal tower configurator

To use Eaton's signal tower configurator, visit: www.eaton.com/config/signaltower

-	-	SL7-COMBINATION 2011955	SL4-COMBINATION 2011956
---	---	----------------------------	----------------------------

Description	Tube length	For use with	Part no. article no.	For use with	Part no. Article no.
-------------	-------------	--------------	-------------------------	--------------	-------------------------

Base modules

For horizontal mounting
Includes cover
max. 5 modules

Description	Tube length	For use with	Spring-loaded terminals	Push-in terminals
			Part no. article no.	Part no. Article no.
All base modules section will be replaced as after complete device.	100 mm		SL7-CB-100 171443	SL4-PIB-100 171297
	250 mm		SL7-CB-250 171444	SL4-PIB-250 171298
	400 mm		SL7-CB-400 171445	SL4-PIB-400 171299
	800 mm	SL7-L-... SL7-BL-... SL7-FL-... SL7-AP-...	SL7-CB-800 177312	SL4-L-... SL4-BL-... SL4-FL-... SL4-AP-... SL4-PIB-800 177313
All base modules section will be replaced as after complete device.	100 mm		SL7-CB-T-100 171452	SL4-PIB-T-100 171305
	250 mm		SL7-CB-T-250 171453	SL4-PIB-T-250 171306
	400 mm		SL7-CB-T-400 171454	SL4-PIB-T-400 171307
	800 mm		SL7-CB-T-800 178460	SL4-PIB-T-800 178461

SL4 and SL7 Base modules



Description	Tube length	For use with	Part no. article no.	For use with	Part no. Article no.
Base modules For horizontal mounting Includes cover max. 5 modules					
			Spring-loaded terminals		Push-in terminals
 Base with internal fixing holes	-		SL7-CB-IMH 171447		SL4-PIB-IMH 171300
 Base with built-in (pre-assembled) fixing screws	-	SL7-L-... SL7-BL-...	SL7-CB-IMS 171448	SL4-L-... SL4-BL-...	SL4-PIB-IMS 171301
 Base with external fixing holes	-	SL7-FL-... SL7-AP-...	SL7-CB-EMH 171449	SL4-FL-... SL4-AP-...	SL4-PIB-EMH 171302
 Base: can hold tubes with a diameter of 25 mm (±0.5)	-		SL7-CB-TM 179987		SL4-PIB-TM 179986
Base with fast mounting system					
			Screw terminals		Screw terminals
	100 mm		SL7-FMS-100 171456		SL4-FMS-100 171308
	250 mm		SL7-FMS-250 171457		SL4-FMS-250 171309
	400 mm		SL7-FMS-400 171458		SL4-FMS-400 171310
	800 mm		SL7-FMS-800 178462		SL4-FMS-800 178463
			Blade terminal SWD4-8MF2		Blade terminal SWD4-8MF2
 max. 5 modules max. 0.3 A per module An external power supply can be connected (24 V DC) Configurable with the SWD Assist planning and ordering tool	100 mm		SL7-SWD 171459		SL4-SWD 171311
Identical to SL7-FMS... and SL7-SWD					
	max. 4 modules AS-Interface version 2.0 Power supply via AS-i (max. 190 mA)		SL7-FMS-ASI-V20 197318		-
	max. 4 modules AS-Interface version 2.0 Power supply via external source (24 V DC)		SL7-FMS-ASI-V20E 197319		-
	max. 3 modules AS-Interface version 2.1 Power supply via AS-i (max. 190 mA)		SL7-FMS-ASI-V21 197320		-
	max. 3 modules AS-Interface version 2.1 Power supply via external voltage source (24 V DC)	100 mm	SL7-L(24)-... SL7-BL24-... SL7-FL24-... SL7-AP24-...	SL7-FMS-ASI-V21E 197321	-
	max. 4 modules AS-Interface version 3.0 Power supply via AS-i (max. 190 mA)		SL7-FMS-ASI-V30 197322		-
	max. 4 modules AS-Interface version 3.0 Power supply via external voltage source (24 V DC)		SL7-FMS-ASI-V30E 197323		-

SL4 and SL7 Base modules and light modules











Description	Tube length	For use with	Part no. Article no.	For use with	Part no. Article no.
For vertical mounting Includes cover					
			Spring-loaded terminals		Push-in terminals
 One-sided base with bracket max. 5 modules	-	SL7-L-... SL7-BL-... SL7-FL-... SL7-AP-...	SL7-CB-FW 171450	SL4-L-... SL4-BL-... SL4-FL-... SL4-AP-...	SL4-PIB-FW 171303
For vertical mounting on both sides Includes cover					
			Spring-loaded terminals		Push-in terminals
 Base with external fixing holes Max. 2 x 5 modules	-	SL7-L-... SL7-BL-... SL7-FL-... SL7-AP-...	SL7-CB-D 171451	SL4-L-... SL4-BL-... SL4-FL-... SL4-AP-...	SL4-PIB-D 171304
For vertical mounting on one side Includes cover					
			M12A plug, 4-pole		
 Base with external fixing holes max. 3 modules	-	SL7-L-... SL7-BL-... SL7-FL-... SL7-AP-...	SL7-CB-D-M12A4 177351		
Module with LED, IP66					
	Rated operational voltage¹⁾ U_e V	Color	Continuous light	Flashing light 2 Hz	Strobe light 1.4 Hz
			Part no. Article no.	Part no. Article no.	Part no. Article no.
	24 V AC/DC		SL7-L24-B 171461	SL7-BL24-B 171439	SL7-FL24-B 171402
			SL7-L24-G 171462	SL7-BL24-G 171440	SL7-FL24-G 171403
			SL7-L24-R 171463	SL7-BL24-R 171441	SL7-FL24-R 171404
			SL7-L24-W 171464	SL7-BL24-W 171442	SL7-FL24-W 171405
			SL7-L24-Y 171465	SL7-BL24-Y 171388	SL7-FL24-Y 171406
			SL7-L24-A 171466	SL7-BL24-A 171389	SL7-FL24-A 171407
	230/240 V AC		SL7-L230-B 171473	SL7-BL230-B 171396	SL7-FL230-B 171414
			SL7-L230-G 171474	SL7-BL230-G 171397	SL7-FL230-G 171415
			SL7-L230-R 171475	SL7-BL230-R 171398	SL7-FL230-R 171416
			SL7-L230-W 171476	SL7-BL230-W 171399	SL7-FL230-W 171417
			SL7-L230-Y 171477	SL7-BL230-Y 171400	SL7-FL230-Y 171418
			SL7-L230-A 171426	SL7-BL230-A 171401	SL7-FL230-A 171419

Note: ¹⁾ 110/120 V AC - online catalog

SL4 and SL7 Light modules and acoustic modules





Rated operational voltage ¹⁾ U _e V	Color	Continuous light	Flashing light 2 Hz	Strobe light 1.4 Hz	Multistrobe light 1 - 2.6 Hz	
		Part no. Article no.	Part no. Article no.	Part no. Article no.	Part no. Article no.	
High-performance LED module, IP66						
24 V AC/DC		SL7-L24-B-HP 171427	-	SL7-FL24-B-HP 171420	SL7-FL24-B-HPM 171275	
		SL7-L24-G-HP 171428	-	SL7-FL24-G-HP 171421	SL7-FL24-G-HPM 171276	
		SL7-L24-R-HP 171429	-	SL7-FL24-R-HP 171422	SL7-FL24-R-HPM 171277	
		SL7-L24-W-HP 171430	-	SL7-FL24-W-HP 171423	SL7-FL24-W-HPM 171278	
		SL7-L24-Y-HP 171431	-	SL7-FL24-Y-HP 171273	SL7-FL24-Y-HPM 171279	
		SL7-L24-A-HP 171432	-	SL7-FL24-A-HP 171274	SL7-FL24-A-HPM 171280	
Module with LED, IP66						
24 V AC/DC		SL4-L24-B 171313	SL4-BL24-B 171337	SL4-FL24-B 171355	SL4-FL24-B-M 171373	
		SL4-L24-G 171314	SL4-BL24-G 171338	SL4-FL24-G 171356	SL4-FL24-G-M 171374	
		SL4-L24-R 171315	SL4-BL24-R 171339	SL4-FL24-R 171357	SL4-FL24-R-M 171375	
		SL4-L24-W 171316	SL4-BL24-W 171340	SL4-FL24-W 171358	SL4-FL24-W-M 171376	
		SL4-L24-Y 171317	SL4-BL24-Y 171341	SL4-FL24-Y 171359	SL4-FL24-Y-M 171377	
		SL4-L24-A 171318	SL4-BL24-A 171342	SL4-FL24-A 171360	SL4-FL24-A-M 171378	
	230/240 V AC		SL4-L230-B 171325	SL4-BL230-B 171349	SL4-FL230-B 171367	-
			SL4-L230-G 171326	SL4-BL230-G 171350	SL4-FL230-G 171368	-
			SL4-L230-R 171327	SL4-BL230-R 171351	SL4-FL230-R 171369	-
			SL4-L230-W 171328	SL4-BL230-W 171352	SL4-FL230-W 171370	-
			SL4-L230-Y 171329	SL4-BL230-Y 171353	SL4-FL230-Y 171371	-
			SL4-L230-A 171330	SL4-BL230-A 171354	SL4-FL230-A 171372	-

1) 110/120 V AC - online catalog

Description	Rated operating voltage ¹⁾ U _e V	Rated operational current I _e mA	Color	Type of tone	Part no. Article no.
Acoustic modules, IP66					
Place only at the highest position of a tower.					
	Continuous tone or pulsed tone, adjustable with internal dip switch.	24 V AC/DC	max. 92		SL7-AP24 171281
	Sound pressure: 100 db, adjustable via an internal potentiometer f = 2800 Hz	230/240 V AC	max. 43		SL7-AP230 171283
	Continuous tone or pulsed tone, external actuation. Assigned two inputs (2 modules).	24 V AC/DC	max. 92		SL7-AP24-E 171284
	Sound pressure: 100 db, adjustable via an internal potentiometer f = 2800 Hz	230/240 V AC	max. 43		SL7-AP230-E 171286
	Multi-tone; 8 tones, adjustable via an internal dip switch.	24 V AC/DC	max. 115		SL7-AP24-M 171287
	Sound pressure: 100 db, adjustable via an internal potentiometer f = 500 - 2700 Hz	230/240 V AC	max. 43		SL7-AP230-M 171289
	Continuous tone or pulsed tone, adjustable via an internal dip switch.	24 V AC/DC	max. 39		SL4-AP24 171379
	Sound pressure: 80 dB. f = 4000 Hz	230/240 V AC	max. 21		SL4-AP230 171381

Note: ¹⁾ 110/120 V AC - online catalog

SL4 and SL7 Accessories

	Lifespan h	Rated operational voltage U _e V	Power	For use with	Part no. Article no.
Magnetic base, includes M20 cable gland					
For vertical mounting, metal and plastic					
	-	-	-	SL4-PIB-100(250)(400) SL7-CB-100(250)(400)	SL7/4-MMS 172954
Mounting bracket					
For vertical mounting, plastic					
	-	-	-	SL4-PIB-100(250)(400) SL4-FMS... SL7-CB-100(250)(400) SL7-FMS...	SL7/4-FW 171446
Mounting bracket, includes M20 cable gland					
For vertical mounting, metal					
	-	-	-	SL4-PIB-T... SL7-CB-T...	SL7/4-FW-T 171455
Replacement cover					
for signal towers					
	-	-	-	SL7-... SL4-...	SL7-COV 192368 SL4-COV 192369

Eaton is an intelligent power management company dedicated to improving the quality of life and protecting the environment for people everywhere. We are guided by our commitment to do business right, to operate sustainably and to help our customers manage power – today and well into the future. By capitalizing on the global growth trends of electrification and digitalization, we're accelerating the planet's transition to renewable energy, helping to solve the world's most urgent power management challenges, and doing what's best for our stakeholders and all of society.

For more information, visit www.eaton.com.

Eaton addresses worldwide: [Eaton.com/contacts](https://www.eaton.com/contacts)



Eaton

EMEA Headquarters
Route de la Longeraie 7
1110 Morges, Switzerland
[Eaton.com](https://www.eaton.com)

Electrical Sector

Eaton Industries GmbH
Hein-Moeller-Str. 7-11
53115 Bonn
Germany

© 2024 Eaton
All Rights Reserved
Publication No. BR047017EN
June 2024

The products, information and prices contained in this document are subject to change. The same is true for any errors or omissions. Only the order confirmation and the technical documentation received from Eaton are binding. Photos and illustrations are indicative only and do not serve as proof of any appearance or functionality. Their use in any form must be approved in advance by Eaton. The same applies for brand names (in particular Eaton, Moeller, Cutler-Hammer, Cooper and Bussmann). Eaton's terms of sale, as published on Eaton's websites and included with order confirmations received from Eaton, apply.

Eaton is a registered trademark.

All other trademarks are property of their respective owners.