

Product data sheet Spirotech

Product name

SpiroTrap -DN65 -Magnet -Flange

Product properties

A steel dirt separator with magnet for standard flow rate (1.5 m/s) with a DN50 - DN300 PN16 flange connection

- Very small particles, from 5 μm (= 0.005 mm) are separated and removed
- Integrated magnet for extra protection and removal of magnetite
- Dirt can be drained while the system is in operation
- No shut-off valves or bypass required
- Applicable with 50/50 Ethylene Glycol / Water (Volume)
- Constant low pressure drop
- Maintenance only takes a few seconds
- No unnecessary downtime
- PN16 flange connection
- Connection diameters from DN50 to DN 300, larger connection diameters on request

Article number

BE065FM

Product image



Product dimensions

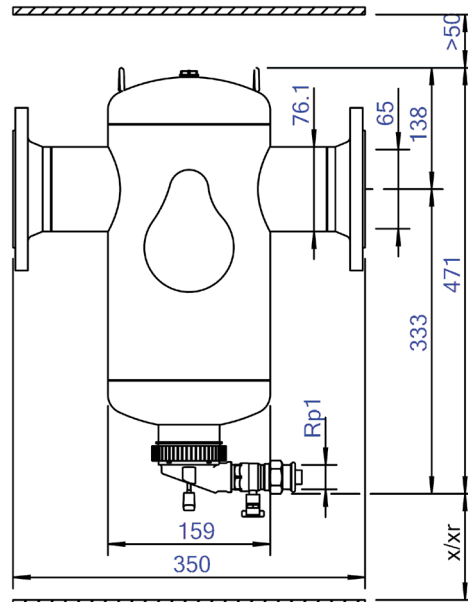

Product data sheet Spirotech

ETIM product data

Housing material	Steel	Suitable for open system	No
With drain valve	Yes	Suitable for closed system	Yes
Housing material quality	St 37 (1.0254)	Suitable for solar	No
Backwash filter	No	Whirl operating principle	No
Medium temperature (continuous)	0 - 110 °C	Negative pressure operating principle	No
Max. operating pressure	10 bar	With dismountable filter	No
KVS value [m ³ /h] at ΔP 1 bar	116.1	Filter volume	5 l
Variable flow direction	Yes	Magnet operating principle	Yes
With insulation	No	Thrust operating principle	No
Separator type	Dirt	With automatic de-aerator	No
Connection	Flange	Partial flow principle	No
Model	Horizontal	Principle full flow with settling	Yes
Nominal diameter	DN 65	Cleaning possible during operation	Yes
Max. glycol mixture	50 %	With couplers	Yes
Suitable for heating	Yes	Inlet/outlet offset distance	0 mm
Suitable for cooling	Yes	Material of connection	Steel
Construction length	350 mm	Flow-through capacity	0 - 20 m ³ /h
Article compression class	PN 10	Magnet location	Internal
Surface protection	Lacquered	Flange standard	DIN

Disclaimer

This product sheet has been compiled with the greatest possible care. Nevertheless, it may contain errors or omissions. For the most current and correct information we refer you to our website

