

# Data Sheet | Item Number: 2061-902

Board-to-Board Link; Pin spacing 6 mm; 2-pole; Length: 30 mm; white

<https://www.wago.com/2061-902>

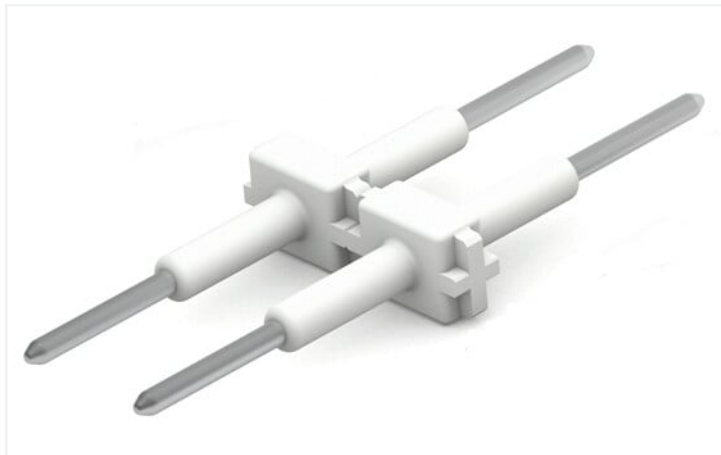

Color: ■ white

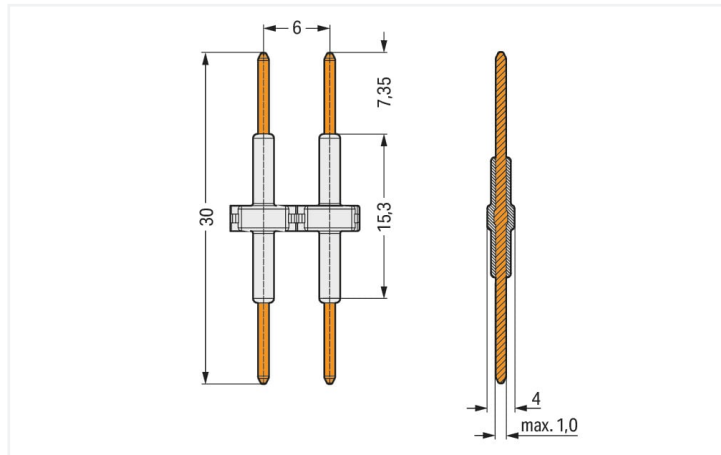

Dimensions in mm

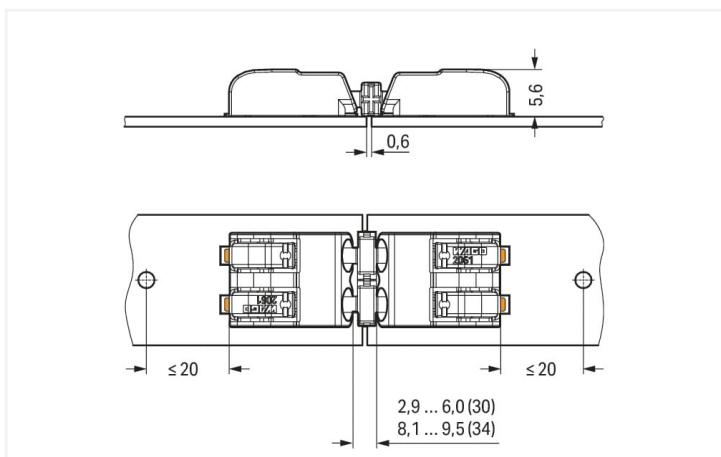

Dimensions in mm

- Board-to-board links simplify in-line assembly of LED modules
- Easy push-in connection and disconnection without push-button actuation

## Electrical data

Ratings per	IEC/EN 60664-1		
Overvoltage category	III	III	II
Pollution degree	3	2	2
Nominal voltage	250 V	320 V	630 V
Rated surge voltage	4 kV	4 kV	4 kV
Rated current	9 A	9 A	9 A

## Connection data

Total number of potentials	2
----------------------------	---

### Connection 1

Pole number	2
-------------	---

### Physical data

Pin spacing	6 mm / 0.236 inches
Width	11.7 mm / 0.461 inches
Height	2.5 mm / 0.098 inches
Depth	30 mm / 1.181 inches

### Mechanical data

Mating cycles (max.)	10
Number of mating cycles	10 connections/disconnections (max.)
Suitable	for SMD PCB terminal blocks (2061 Series)

### Material data

Note (material data)	<a href="https://www.wago.com/us/material-specifications">Information on material specifications can be found here</a>
Color	white
Material group	I
Insulation material	Polyamide (PA66)
Flammability class per UL94	V0
Contact material	Copper alloy
Contact plating	Silver
Fire load	0 MJ
Weight	0.6 g

### Environmental requirements

Limit temperature range	-60 ... +105 °C
-------------------------	-----------------

### Commercial data

eCl@ss 10.0	27-14-11-92
eCl@ss 9.0	27-14-11-92
ETIM 8.0	EC002848
ETIM 7.0	EC002848
PU (SPU)	300 pcs
Packaging type	Box
Country of origin	CN
GTIN	4055143656832
Customs tariff number	85369010000

### Environmental Product Compliance

RoHS Compliance Status	Compliant, No Exemption
------------------------	-------------------------

## Approvals / Certificates

### General approvals



Approval	Standard	Certificate Name
CCA DEKRA Certification B.V.	EN 60947-7-4	NTR NL-7773
CCA DEKRA Certification B.V.	EN 60947-7-4	71-110254
CCA DEKRA Certification B.V.	EN 60838	NTR NL-7721
cURus Underwriters Laboratories Inc.	UL 1059	E45172
KEMA/KEUR DEKRA Certification B.V.	EN 60838	71-106232

## Downloads

### Environmental Product Compliance

#### Compliance Search

Environmental Product  
Compliance 2061-902



## Documentation

### Additional Information

Technical Section

03.04.2019

pdf  
2010.85 KB



## CAD/CAE-Data

### CAD data

2D/3D Models  
2061-902



### CAE data

ZUKEN Portal  
2061-902



## Installation Notes

### Installation

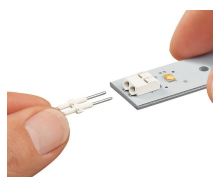

Inserting a board-to-board link into the  
terminal block.

## Installation

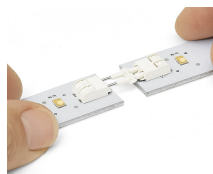

Assembly: Place PCBs on a flat surface and connect terminal blocks on adjoining PCBs via board-to-board link.

Disassembly: Pull PCBs apart (max. 10 mating cycles).

## Installation



The PCBs must be secured.