













83 510 892 Product version from 4/1/2024



- width 152mm
- height 100 mm
- rosette Ø 55 mm
- 77mm projection

	Platinum	83 510 892-08
	Chrome	83 510 892-00
	Brushed Platinum	83 510 892-06
	Dark Chrome	83 510 892-19
	Brushed Durabronze (23kt Gold)	83 510 892-28
	Matte Black	83 510 892-33
	Brushed Gold (PVD)	83 510 892-37
	Brushed Dark Brass (PVD)	83 510 892-39
	Brushed Bronze (PVD)	83 510 892-42
	Brushed Dark Bronze (PVD)	83 510 892-43
	Brushed Champagne (22kt Gold)	83 510 892-46
	Champagne (22kt Gold)	83 510 892-47
	Brushed Chrome	83 510 892-93
	Brushed Dark Platinum	83 510 892-99

83 510 892 Product version from 4/1/2024

mm [inches]

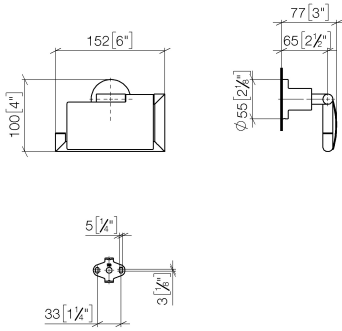

83 510 892 Product version from 4/1/2024

Parts for other finishes can be found here: [Chrome](#)

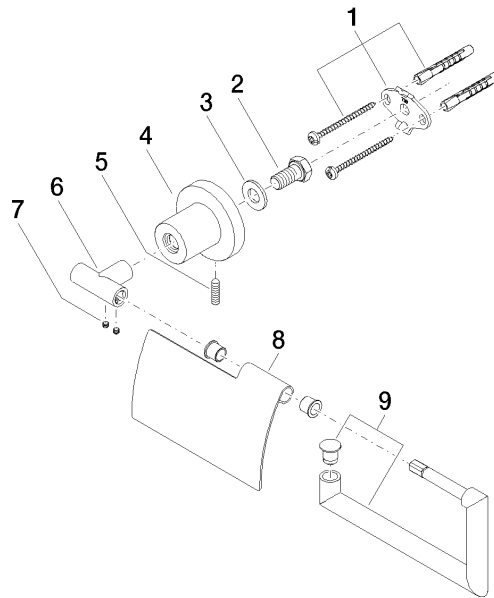

### Spare parts list

No.	Item Number	Name	Quantity used	Delivery time
	5 04 31 11 113 00 90	Mounting Threaded pin M5 x 12 mm -	1.00	14
	2 09 30 30 071 90	Mounting Hexagonal bolt with thread as far as head M10 x 20 mm -	1.00	14
	3 09 30 11 046 90	Washer Ø 10,5 -	1.00	14
	8 08 11 02 514-08	Cover for toilet roll holder 120 x 77 x 18 mm - Platinum	1.00	54
	6 05 17 89 553 00-08	Holder for toilet roll holder with cover 31,5 x 14 x 40 mm - Platinum	1.00	54
	7 90 31 11 038 00 90	Mounting Threaded pin with hexagon socket with cup point M4 x 3 mm -	2.00	14
	4 08 17 89 505-08	Holder universal 60 x 100 x 60 mm - Platinum	1.00	54
	1 05 17 20 739 00 90	Attachment set 150 x 65 x 10 mm -	1.00	14
	9 90 28 22 641 00-08	Holder 154 x 80 x 17 mm - Platinum	1.00	54