

Product data sheet Spirotech

Product name

SpiroCombi -DN200 -Flange -Demount

Product properties

A demountable steel (microbubble) deaerator and dirt separator for standard flow rate (1.5 m/s) with a DN50 - DN300 PN16 flange connection

- Combined separation system - removes circulating air and microbubbles effectively
- Improve cost control and energy efficiency
- Applicable with 50/50 Ethylene Glycol / Water (Volume)
- Very small particles, from 5 μm (= 0.005 mm), are separated and removed
- Dirt can be discharged while the system is in operation
- We recommend equipping the separator with shut-off valves on both sides
- In case of severe pollution and/or maintenance, the unit is demountable
- Constant low pressure drop
- PN16 flange connections
- Connection diameters from DN50 - DN300, larger connection diameters on request
- Exceptional guarantee

Article number

BD200F

Product image



Product dimensions

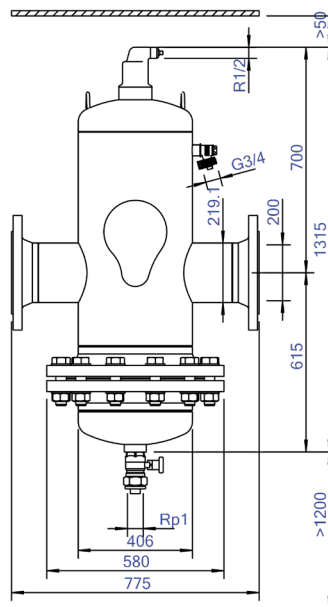

Product data sheet Spirotech

ETIM product data

| | |
|---|----------------|
| Housing material | Steel |
| With drain valve | Yes |
| Housing material quality | St 37 (1.0254) |
| Backwash filter | No |
| Medium temperature (continuous) | 0 - 110 °C |
| Max. operating pressure | 10 bar |
| KVS value [m ³ /h] at ΔP 1 bar | 743.9 |
| Variable flow direction | Yes |
| With insulation | No |
| Separator type | Air/dirt |
| Connection | Flange |
| Model | Horizontal |
| Nominal diameter | DN 200 |
| Max. glycol mixture | 50 % |
| Suitable for heating | Yes |
| Suitable for cooling | Yes |

| | |
|------------------------------------|---------------------------|
| Construction length | 775 mm |
| Article compression class | PN 10 |
| Surface protection | Lacquered |
| Suitable for open system | No |
| Suitable for closed system | Yes |
| Suitable for solar | No |
| With dismountable filter | Yes |
| Filter volume | 150 l |
| Magnet operating principle | No |
| With automatic de-aerator | Yes |
| Cleaning possible during operation | Yes |
| With couplers | No |
| Inlet/outlet offset distance | 0 mm |
| Material of connection | Steel |
| Flow-through capacity | 0 - 180 m ³ /h |
| Flange standard | DIN |

Disclaimer

This product sheet has been compiled with the greatest possible care. Nevertheless, it may contain errors or omissions. For the most current and correct information we refer you to our website

