

Data Sheet | Item Number: 270-585

3-conductor actuator supply terminal block; with colored conductor entries; 2.5 mm²; CAGE CLAMP®; 2,50 mm²; gray

<https://www.wago.com/270-585>

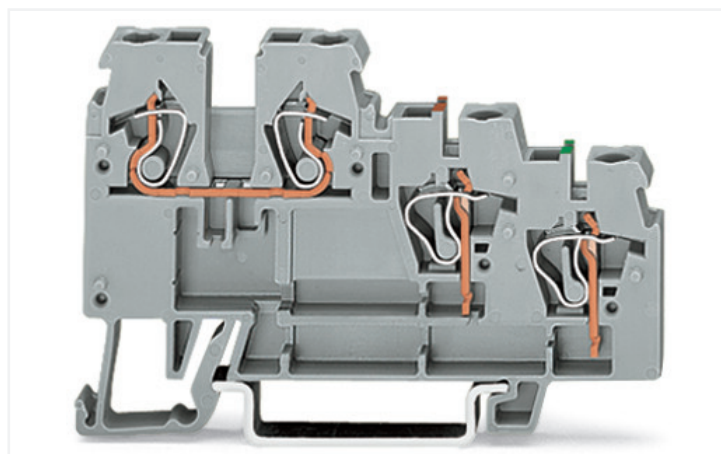
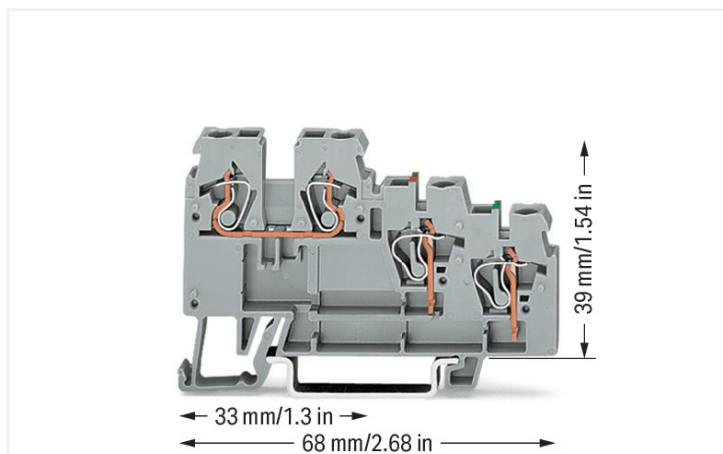

Color: ■ gray

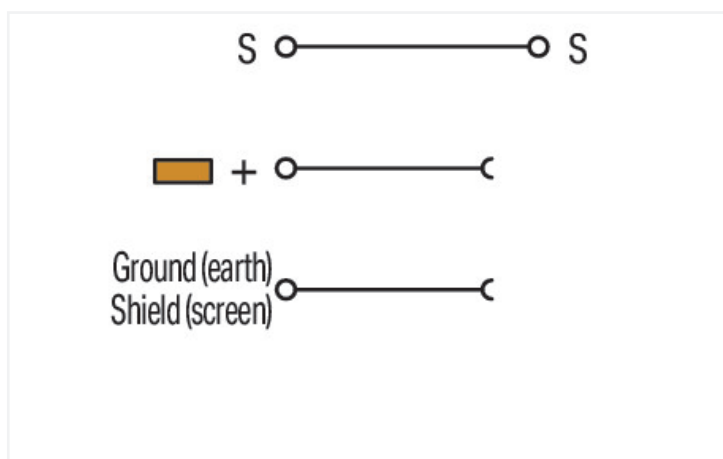

270-585

Electrical data

Ratings per IEC/EN

Nominal voltage (III/3)	250 V
Rated impulse voltage (III/3)	4 kV
Rated current	18 A
Legend (ratings)	(III / 3) ≙ Overvoltage category III / Pollution degree 3

Power Loss

Power loss, per pole (potential)	0.4309 W
Rated current I_N for specified power loss	18 A
Resistance value for specified, current-dependent power loss	0.00133 Ω

Connection data

Connection points	4
Total number of potentials	3
Number of levels	3

Connection 1

Connection technology	CAGE CLAMP®
Actuation type	Operating tool
Connectable conductor materials	Copper
Solid conductor	0.08 ... 2.5 mm ² / 28 ... 12 AWG
Fine-stranded conductor	0.08 ... 2.5 mm ² / 28 ... 12 AWG
Note (conductor cross-section)	12 AWG: THHN, THWN
Strip length	6 ... 7 mm / 0.24 ... 0.28 inches
Wiring direction	Front-entry wiring

Physical data

Width	5 mm / 0.197 inches
Height	68 mm / 2.677 inches
Depth from upper-edge of DIN-rail	39 mm / 1.535 inches

Mechanical data

Design	horizontal type
Mounting type	DIN-35 rail
Marking level	Side marking

Material data

Note (material data)	Information on material specifications can be found here
Color	gray
Material group	I
Insulation material	Polyamide (PA66)
Flammability class per UL94	V0
Fire load	0.172 MJ
Weight	8.8 g

Environmental requirements

Processing temperature	-35 ... +85 °C
Continuous operating temperature	-60 ... +105 °C

Commercial data

Product Group	1 (Rail Mounted Terminal Blocks)
eCl@ss 10.0	27-14-11-28
eCl@ss 9.0	27-14-11-28
ETIM 8.0	EC000900
ETIM 7.0	EC000900
PU (SPU)	50 pcs
Packaging type	Box
Country of origin	CN
GTIN	4050821035282
Customs tariff number	85369010000

Environmental Product Compliance

RoHS Compliance Status	Compliant, No Exemption
------------------------	-------------------------

Approvals / Certificates

General approvals



Approval	Standard	Certificate Name
CCA DEKRA Certification B.V.	EN 60947	NTR NL 6828
CCA DEKRA Certification B.V.	EN 60947	2143311.03
CSA DEKRA Certification B.V.	C22.2	1565649

General approvals

UR Underwriters Laboratories Inc.	UL 1059	E45172
---	---------	--------

Declarations of conformity and manufacturer's declarations

Approval	Standard	Certificate Name
EU-Declaration of Conformity WAGO GmbH & Co. KG	-	-
UK-Declaration of Conformity WAGO GmbH & Co. KG	-	-

Downloads

Environmental Product Compliance

Compliance Search
Environmental Product Compliance 270-585 ↓

Documentation

Additional Information
Technical Section pdf 2240.62 KB ↓

Bid Text				
270-585	19.02.2019	xml	3.21 KB	↓
270-585	31.05.2017	doc	24.00 KB	↓

CAD/CAE-Data

CAD data
2D/3D Models 270-585 ↓

CAE data
EPLAN Data Portal 270-585 ↓
WSCAD Universe 270-585 ↓
ZUKEN Portal 270-585 ↓

1 Compatible Products

1.1 Required Accessories

1.1.1 End plate

1.1.1.1 End plate



[Item No.: 270-319](#)
End and intermediate plate; 1 mm thick; for triple-deck terminal blocks; gray

[Item No.: 270-321](#)
End and intermediate plate; 1 mm thick; for triple-deck terminal blocks; orange

1.2 Optional Accessories

1.2.1 Ferrule

1.2.1.1 Ferrule



Item No.: 216-321

Ferrule; Sleeve for 0.25 mm² / AWG 24; insulated; electro-tin plated; yellow



Item No.: 216-131

Ferrule; Sleeve for 0.25 mm² / AWG 24; uninsulated; electro-tin plated; silver-colored



Item No.: 216-322

Ferrule; Sleeve for 0.34 mm² / 22 AWG; insulated; electro-tin plated; light turquoise



Item No.: 216-132

Ferrule; Sleeve for 0.34 mm² / AWG 24; uninsulated; electro-tin plated



Item No.: 216-221

Ferrule; Sleeve for 0.5 mm² / 20 AWG; insulated; electro-tin plated; white



Item No.: 216-121

Ferrule; Sleeve for 0.5 mm² / AWG 22; uninsulated; electro-tin plated; silver-colored



Item No.: 216-222

Ferrule; Sleeve for 0.75 mm² / 18 AWG; insulated; electro-tin plated; gray



Item No.: 216-122

Ferrule; Sleeve for 0.75 mm² / AWG 20; uninsulated; electro-tin plated; silver-colored



Item No.: 216-223

Ferrule; Sleeve for 1 mm² / AWG 18; insulated; electro-tin plated; red



Item No.: 216-123

Ferrule; Sleeve for 1 mm² / AWG 18; uninsulated; electro-tin plated; silver-colored



Item No.: 216-224

Ferrule; Sleeve for 1.5 mm² / AWG 16; insulated; electro-tin plated; black



Item No.: 216-124

Ferrule; Sleeve for 1.5 mm² / AWG 16; uninsulated; electro-tin plated

1.2.2 Installation

1.2.2.1 Cover



Item No.: 709-153

Cover; Type 1; suitable for cover carrier, type 1; 1 m long; transparent

1.2.2.2 Cover carrier



Item No.: 709-167

Cover carrier; Type 1; incl. fixing/retaining screws and knurled nut; suitable for 279 to 282 and 880 Series rail-mounted terminal blocks; suitable for 264 Series miniature rail-mounted terminal blocks; suitable for 270 Series sensor and actuator terminal blocks; gray

1.2.3 Insulation stop

1.2.3.1 Insulation stop



Item No.: 280-470

Insulation stop; 0.08 - 0.2 mm² "s" (0.14 mm² "f-st"); 5 pieces/strip; white



Item No.: 280-471

Insulation stop; 0.25 - 0.5 mm²; 5 pieces/strip; light gray



Item No.: 280-472

Insulation stop; 0.75 - 1 mm²; 5 pieces/strip; black





























1.2.4 Jumper

1.2.4.1 Jumper

 Item No.: 870-405/011-000	 Item No.: 870-407/011-000	 Item No.: 870-409/011-000	 Item No.: 270-417 Jumper; 17-way; silver-colored
 Item No.: 870-402 Jumper; 2-way; insulated; light gray	 Item No.: 870-403 Jumper; 3-way; insulated; light gray	 Item No.: 870-404 Jumper; 4-way; insulated; light gray	 Item No.: 870-405 Jumper; 5-way; insulated; light gray
 Item No.: 870-406 Jumper; 6-way; insulated; light gray	 Item No.: 870-407 Jumper; 7-way; insulated; light gray	 Item No.: 270-480 Jumper; 80-way; silver-colored	 Item No.: 870-408 Jumper; 8-way; insulated; light gray
 Item No.: 870-409 Jumper; 9-way; insulated; light gray	 Item No.: 270-409 Jumper; 9-way; silver-colored		

1.2.5 Marking

1.2.5.1 Marker

 Item No.: 2009-145/000-006 Mini-WSB Inline; for Smart Printer; 1700 pieces on roll; stretchable 5 - 5.2 mm; plain; snap-on type; blue	 Item No.: 2009-145/000-007 Mini-WSB Inline; for Smart Printer; 1700 pieces on roll; stretchable 5 - 5.2 mm; plain; snap-on type; gray	 Item No.: 2009-145/000-023 Mini-WSB Inline; for Smart Printer; 1700 pieces on roll; stretchable 5 - 5.2 mm; plain; snap-on type; green	 Item No.: 2009-145/000-012 Mini-WSB Inline; for Smart Printer; 1700 pieces on roll; stretchable 5 - 5.2 mm; plain; snap-on type; orange
 Item No.: 2009-145/000-005 Mini-WSB Inline; for Smart Printer; 1700 pieces on roll; stretchable 5 - 5.2 mm; plain; snap-on type; red	 Item No.: 2009-145/000-024 Mini-WSB Inline; for Smart Printer; 1700 pieces on roll; stretchable 5 - 5.2 mm; plain; snap-on type; violet	 Item No.: 2009-145 Mini-WSB Inline; for Smart Printer; 1700 pieces on roll; stretchable 5 - 5.2 mm; plain; snap-on type; white	 Item No.: 2009-145/000-002 Mini-WSB Inline; for Smart Printer; 1700 pieces on roll; stretchable 5 - 5.2 mm; plain; snap-on type; yellow
 Item No.: 248-501/000-006 Mini-WSB marking card; as card; not stretchable; plain; snap-on type; blue	 Item No.: 248-501/000-007 Mini-WSB marking card; as card; not stretchable; plain; snap-on type; gray	 Item No.: 248-501/000-023 Mini-WSB marking card; as card; not stretchable; plain; snap-on type; green	 Item No.: 248-501/000-017 Mini-WSB marking card; as card; not stretchable; plain; snap-on type; light green
 Item No.: 248-501/000-012 Mini-WSB marking card; as card; not stretchable; plain; snap-on type; orange	 Item No.: 248-501/000-005 Mini-WSB marking card; as card; not stretchable; plain; snap-on type; red	 Item No.: 248-501/000-024 Mini-WSB marking card; as card; not stretchable; plain; snap-on type; violet	 Item No.: 248-501 Mini-WSB marking card; as card; not stretchable; plain; snap-on type; white
 Item No.: 248-501/000-002 Mini-WSB marking card; as card; not stretchable; plain; snap-on type; yellow	 Item No.: 793-5501/000-006 WMB marking card; as card; for terminal block width 5 - 17.5 mm; stretchable 5 - 5.2 mm; plain; snap-on type; blue	 Item No.: 793-5501/000-007 WMB marking card; as card; for terminal block width 5 - 17.5 mm; stretchable 5 - 5.2 mm; plain; snap-on type; gray	 Item No.: 793-5501/000-023 WMB marking card; as card; for terminal block width 5 - 17.5 mm; stretchable 5 - 5.2 mm; plain; snap-on type; green
 Item No.: 793-5501/000-017 WMB marking card; as card; for terminal block width 5 - 17.5 mm; stretchable 5 - 5.2 mm; plain; snap-on type; light green	 Item No.: 793-5501/000-012 WMB marking card; as card; for terminal block width 5 - 17.5 mm; stretchable 5 - 5.2 mm; plain; snap-on type; orange	 Item No.: 793-5501/000-005 WMB marking card; as card; for terminal block width 5 - 17.5 mm; stretchable 5 - 5.2 mm; plain; snap-on type; red	 Item No.: 793-5501/000-024 WMB marking card; as card; for terminal block width 5 - 17.5 mm; stretchable 5 - 5.2 mm; plain; snap-on type; violet
 Item No.: 793-5501 WMB marking card; as card; for terminal block width 5 - 17.5 mm; stretchable 5 - 5.2 mm; plain; snap-on type; white	 Item No.: 793-5501/000-002 WMB marking card; as card; for terminal block width 5 - 17.5 mm; stretchable 5 - 5.2 mm; plain; snap-on type; yellow	 Item No.: 793-501/000-006 WMB marking card; as card; not stretchable; plain; snap-on type; blue	 Item No.: 793-501/000-007 WMB marking card; as card; not stretchable; plain; snap-on type; gray

1.2.5.1 Marker



Item No.: 793-501/000-023
WMB marking card; as card; not stretchable; plain; snap-on type; green



Item No.: 793-501/000-017
WMB marking card; as card; not stretchable; plain; snap-on type; light green



Item No.: 793-501/000-012
WMB marking card; as card; not stretchable; plain; snap-on type; orange



Item No.: 793-501/000-005
WMB marking card; as card; not stretchable; plain; snap-on type; red



Item No.: 793-501/000-024
WMB marking card; as card; not stretchable; plain; snap-on type; violet



Item No.: 793-501
WMB marking card; as card; not stretchable; plain; snap-on type; white



Item No.: 793-501/000-002
WMB marking card; as card; not stretchable; plain; snap-on type; yellow



Item No.: 2009-115/000-006
WMB-Inline; for Smart Printer; 1500 pieces on roll; stretchable 5 - 5.2 mm; plain; snap-on type; blue



Item No.: 2009-115/000-007
WMB-Inline; for Smart Printer; 1500 pieces on roll; stretchable 5 - 5.2 mm; plain; snap-on type; gray



Item No.: 2009-115/000-023
WMB-Inline; for Smart Printer; 1500 pieces on roll; stretchable 5 - 5.2 mm; plain; snap-on type; green



Item No.: 2009-115/000-017
WMB-Inline; for Smart Printer; 1500 pieces on roll; stretchable 5 - 5.2 mm; plain; snap-on type; light green



Item No.: 2009-115/000-012
WMB-Inline; for Smart Printer; 1500 pieces on roll; stretchable 5 - 5.2 mm; plain; snap-on type; orange



Item No.: 2009-115/000-024
WMB-Inline; for Smart Printer; 1500 pieces on roll; stretchable 5 - 5.2 mm; plain; snap-on type; violet



Item No.: 2009-115
WMB-Inline; for Smart Printer; 1500 pieces on roll; stretchable 5 - 5.2 mm; plain; snap-on type; white



Item No.: 2009-115/000-002
WMB-Inline; for Smart Printer; 1500 pieces on roll; stretchable 5 - 5.2 mm; plain; snap-on type; yellow

1.2.5.2 Marking strip



Item No.: 709-196
Marking strips; for laser printer; translucent



Item No.: 709-177
Marking strips; on reel; 7.5 mm wide; not stretchable; plain; snap-on type; translucent



Item No.: 709-178
Marking strips; on reel; 7.5 mm wide; not stretchable; plain; snap-on type; white

1.2.6 Tool

1.2.6.1 Operating tool



Item No.: 210-720
Operating tool; Blade: 3.5 x 0.5 mm; with a partially insulated shaft; multicoloured



Item No.: 210-657
Operating tool; Blade: 3.5 x 0.5 mm; with a partially insulated shaft; short; multicoloured

Installation Notes

Commoning



Inserting a jumper.

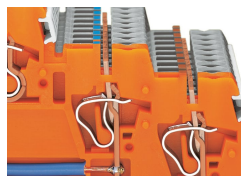

Commoning a supply voltage using uninsulated push-in type jumper bars, 2- to 9-way or 17-way (2 x 8 bits), depending on application.



Commoning signal level voltage via insulated push-in type jumper bars (870 Series) – 2- to 9-way, depending on application. **Sensor LED terminal blocks cannot be commoned!**

Marking



Marking strip (Item No. 709-196)

Not suitable for LED terminal blocks!