

## Data Sheet | Item Number: 270-577

3-conductor sensor/actuator terminal block; with colored conductor entries; 2.5 mm<sup>2</sup>; CAGE CLAMP®; 2,50 mm<sup>2</sup>; orange

<https://www.wago.com/270-577>

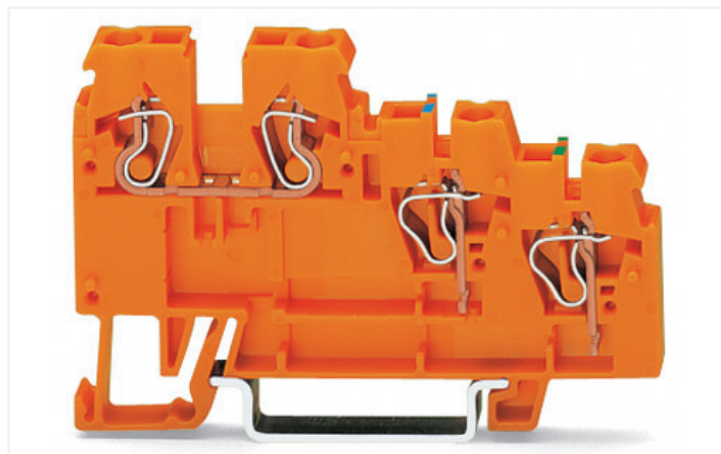
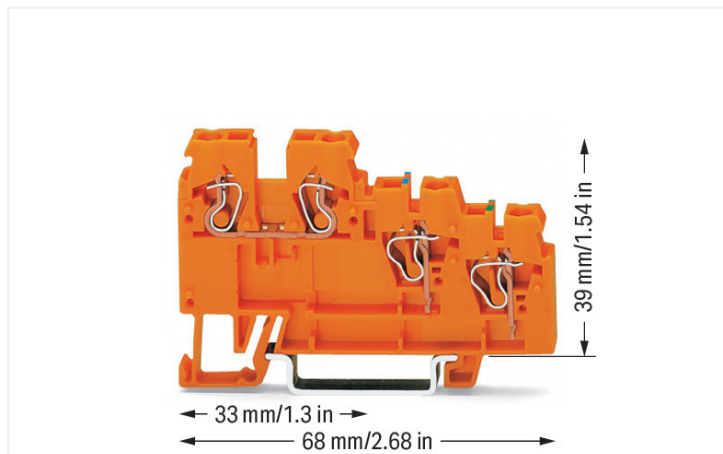

Color: ■ orange

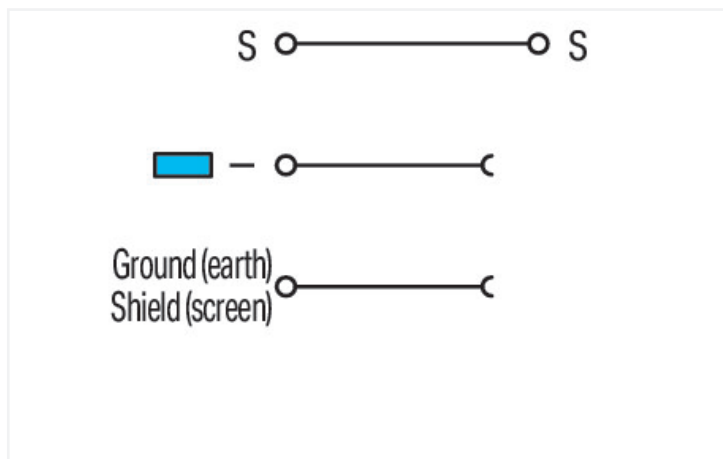

270-577

### Electrical data

#### Ratings per IEC/EN

Nominal voltage (III/3)	250 V
Rated impulse voltage (III/3)	4 kV
Rated current	18 A
Legend (ratings)	(III / 3) ≙ Overvoltage category III / Pollution degree 3

#### Power Loss

Power loss, per pole (potential)	0.4309 W
Rated current $I_N$ for specified power loss	18 A
Resistance value for specified, current-dependent power loss	0.00133 Ω

### Connection data

Connection points	4
Total number of potentials	3
Number of levels	3

#### Connection 1

Connection technology	CAGE CLAMP®
Actuation type	Operating tool
Connectable conductor materials	Copper
Solid conductor	0.08 ... 2.5 mm <sup>2</sup> / 28 ... 12 AWG
Fine-stranded conductor	0.08 ... 2.5 mm <sup>2</sup> / 28 ... 12 AWG
Note (conductor cross-section)	12 AWG: THHN, THWN
Strip length	6 ... 7 mm / 0.24 ... 0.28 inches
Wiring direction	Front-entry wiring

### Physical data

Width	5 mm / 0.197 inches
Height	68 mm / 2.677 inches
Depth from upper-edge of DIN-rail	39 mm / 1.535 inches

### Mechanical data

Design	horizontal type
Mounting type	DIN-35 rail
Marking level	Side marking

### Material data

Note (material data)	<a href="https://www.wago.com/us/material-specifications">Information on material specifications can be found here</a>
Color	orange
Material group	I
Insulation material	Polyamide (PA66)
Flammability class per UL94	V0
Fire load	0.176 MJ
Weight	8.9 g

### Environmental requirements

Processing temperature	-35 ... +85 °C
Continuous operating temperature	-60 ... +105 °C

### Commercial data

Product Group	1 (Rail Mounted Terminal Blocks)
eCl@ss 10.0	27-14-11-28
eCl@ss 9.0	27-14-11-28
ETIM 8.0	EC000900
ETIM 7.0	EC000900
PU (SPU)	10 pcs
Packaging type	Box
Country of origin	CN
GTIN	4050821035275
Customs tariff number	85369010000

### Environmental Product Compliance

RoHS Compliance Status	Compliant, No Exemption
------------------------	-------------------------

### Approvals / Certificates

#### General approvals



Approval	Standard	Certificate Name
CCA DEKRA Certification B.V.	EN 60947	NTR NL 6828
CCA DEKRA Certification B.V.	EN 60947	2143311.03
CSA DEKRA Certification B.V.	C22.2	1565649

#### General approvals

UR Underwriters Laboratories Inc.	UL 1059	E45172
---	---------	--------

Declarations of conformity and manufacturer's declarations

Approval	Standard	Certificate Name
EU-Declaration of Conformity WAGO GmbH & Co. KG	-	-
UK-Declaration of Conformity WAGO GmbH & Co. KG	-	-

Downloads

Environmental Product Compliance

Compliance Search
Environmental Product Compliance 270-577 <a href="#">↓</a>

Documentation

Additional Information
Technical Section pdf 2240.62 KB <a href="#">↓</a>

Bid Text				
270-577	19.02.2019	xml	3.23 KB	<a href="#">↓</a>
270-577	31.05.2017	doc	24.00 KB	<a href="#">↓</a>

CAD/CAE-Data

CAD data
2D/3D Models 270-577 <a href="#">↓</a>

CAE data
EPLAN Data Portal 270-577 <a href="#">↓</a>
WSCAD Universe 270-577 <a href="#">↓</a>
ZUKEN Portal 270-577 <a href="#">↓</a>

1 Compatible Products

1.1 Required Accessories

1.1.1 End plate

1.1.1.1 End plate



[Item No.: 270-319](#)  
End and intermediate plate; 1 mm thick; for triple-deck terminal blocks; gray

[Item No.: 270-321](#)  
End and intermediate plate; 1 mm thick; for triple-deck terminal blocks; orange

## 1.2 Optional Accessories

### 1.2.1 Ferrule

#### 1.2.1.1 Ferrule



**Item No.: 216-321**

Ferrule; Sleeve for 0.25 mm<sup>2</sup> / AWG 24; insulated; electro-tin plated; yellow



**Item No.: 216-131**

Ferrule; Sleeve for 0.25 mm<sup>2</sup> / AWG 24; uninsulated; electro-tin plated; silver-colored



**Item No.: 216-322**

Ferrule; Sleeve for 0.34 mm<sup>2</sup> / 22 AWG; insulated; electro-tin plated; light turquoise



**Item No.: 216-132**

Ferrule; Sleeve for 0.34 mm<sup>2</sup> / AWG 24; uninsulated; electro-tin plated



**Item No.: 216-221**

Ferrule; Sleeve for 0.5 mm<sup>2</sup> / 20 AWG; insulated; electro-tin plated; white



**Item No.: 216-121**

Ferrule; Sleeve for 0.5 mm<sup>2</sup> / AWG 22; uninsulated; electro-tin plated; silver-colored



**Item No.: 216-222**

Ferrule; Sleeve for 0.75 mm<sup>2</sup> / 18 AWG; insulated; electro-tin plated; gray



**Item No.: 216-122**

Ferrule; Sleeve for 0.75 mm<sup>2</sup> / AWG 20; uninsulated; electro-tin plated; silver-colored



**Item No.: 216-223**

Ferrule; Sleeve for 1 mm<sup>2</sup> / AWG 18; insulated; electro-tin plated; red



**Item No.: 216-123**

Ferrule; Sleeve for 1 mm<sup>2</sup> / AWG 18; uninsulated; electro-tin plated; silver-colored



**Item No.: 216-224**

Ferrule; Sleeve for 1.5 mm<sup>2</sup> / AWG 16; insulated; electro-tin plated; black



**Item No.: 216-124**

Ferrule; Sleeve for 1.5 mm<sup>2</sup> / AWG 16; uninsulated; electro-tin plated

### 1.2.2 Installation

#### 1.2.2.1 Cover



**Item No.: 709-153**

Cover; Type 1; suitable for cover carrier, type 1; 1 m long; transparent

#### 1.2.2.2 Cover carrier



**Item No.: 709-167**

Cover carrier; Type 1; incl. fixing/retaining screws and knurled nut; suitable for 279 to 282 and 880 Series rail-mounted terminal blocks; suitable for 264 Series miniature rail-mounted terminal blocks; suitable for 270 Series sensor and actuator terminal blocks; gray

### 1.2.3 Insulation stop

#### 1.2.3.1 Insulation stop



**Item No.: 280-470**

Insulation stop; 0.08 - 0.2 mm<sup>2</sup> "s" (0.14 mm<sup>2</sup> "f-st"); 5 pieces/strip; white



**Item No.: 280-471**

Insulation stop; 0.25 - 0.5 mm<sup>2</sup>; 5 pieces/strip; light gray



**Item No.: 280-472**

Insulation stop; 0.75 - 1 mm<sup>2</sup>; 5 pieces/strip; black





























1.2.4 Jumper

1.2.4.1 Jumper

 <a href="#">Item No.: 870-405/011-000</a>	 <a href="#">Item No.: 870-407/011-000</a>	 <a href="#">Item No.: 870-409/011-000</a>	 <a href="#">Item No.: 270-417</a> Jumper; 17-way; silver-colored
 <a href="#">Item No.: 870-402</a> Jumper; 2-way; insulated; light gray	 <a href="#">Item No.: 870-403</a> Jumper; 3-way; insulated; light gray	 <a href="#">Item No.: 870-404</a> Jumper; 4-way; insulated; light gray	 <a href="#">Item No.: 870-405</a> Jumper; 5-way; insulated; light gray
 <a href="#">Item No.: 870-406</a> Jumper; 6-way; insulated; light gray	 <a href="#">Item No.: 870-407</a> Jumper; 7-way; insulated; light gray	 <a href="#">Item No.: 270-480</a> Jumper; 80-way; silver-colored	 <a href="#">Item No.: 870-408</a> Jumper; 8-way; insulated; light gray
 <a href="#">Item No.: 870-409</a> Jumper; 9-way; insulated; light gray	 <a href="#">Item No.: 270-409</a> Jumper; 9-way; silver-colored		

1.2.5 Marking

1.2.5.1 Marker

 <a href="#">Item No.: 2009-145/000-006</a> Mini-WSB Inline; for Smart Printer; 1700 pieces on roll; stretchable 5 - 5.2 mm; plain; snap-on type; blue	 <a href="#">Item No.: 2009-145/000-007</a> Mini-WSB Inline; for Smart Printer; 1700 pieces on roll; stretchable 5 - 5.2 mm; plain; snap-on type; gray	 <a href="#">Item No.: 2009-145/000-023</a> Mini-WSB Inline; for Smart Printer; 1700 pieces on roll; stretchable 5 - 5.2 mm; plain; snap-on type; green	 <a href="#">Item No.: 2009-145/000-012</a> Mini-WSB Inline; for Smart Printer; 1700 pieces on roll; stretchable 5 - 5.2 mm; plain; snap-on type; orange
 <a href="#">Item No.: 2009-145/000-005</a> Mini-WSB Inline; for Smart Printer; 1700 pieces on roll; stretchable 5 - 5.2 mm; plain; snap-on type; red	 <a href="#">Item No.: 2009-145/000-024</a> Mini-WSB Inline; for Smart Printer; 1700 pieces on roll; stretchable 5 - 5.2 mm; plain; snap-on type; violet	 <a href="#">Item No.: 2009-145</a> Mini-WSB Inline; for Smart Printer; 1700 pieces on roll; stretchable 5 - 5.2 mm; plain; snap-on type; white	 <a href="#">Item No.: 2009-145/000-002</a> Mini-WSB Inline; for Smart Printer; 1700 pieces on roll; stretchable 5 - 5.2 mm; plain; snap-on type; yellow
 <a href="#">Item No.: 248-501/000-006</a> Mini-WSB marking card; as card; not stretchable; plain; snap-on type; blue	 <a href="#">Item No.: 248-501/000-007</a> Mini-WSB marking card; as card; not stretchable; plain; snap-on type; gray	 <a href="#">Item No.: 248-501/000-023</a> Mini-WSB marking card; as card; not stretchable; plain; snap-on type; green	 <a href="#">Item No.: 248-501/000-017</a> Mini-WSB marking card; as card; not stretchable; plain; snap-on type; light green
 <a href="#">Item No.: 248-501/000-012</a> Mini-WSB marking card; as card; not stretchable; plain; snap-on type; orange	 <a href="#">Item No.: 248-501/000-005</a> Mini-WSB marking card; as card; not stretchable; plain; snap-on type; red	 <a href="#">Item No.: 248-501/000-024</a> Mini-WSB marking card; as card; not stretchable; plain; snap-on type; violet	 <a href="#">Item No.: 248-501</a> Mini-WSB marking card; as card; not stretchable; plain; snap-on type; white
 <a href="#">Item No.: 248-501/000-002</a> Mini-WSB marking card; as card; not stretchable; plain; snap-on type; yellow	 <a href="#">Item No.: 793-5501/000-006</a> WMB marking card; as card; for terminal block width 5 - 17.5 mm; stretchable 5 - 5.2 mm; plain; snap-on type; blue	 <a href="#">Item No.: 793-5501/000-007</a> WMB marking card; as card; for terminal block width 5 - 17.5 mm; stretchable 5 - 5.2 mm; plain; snap-on type; gray	 <a href="#">Item No.: 793-5501/000-023</a> WMB marking card; as card; for terminal block width 5 - 17.5 mm; stretchable 5 - 5.2 mm; plain; snap-on type; green
 <a href="#">Item No.: 793-5501/000-017</a> WMB marking card; as card; for terminal block width 5 - 17.5 mm; stretchable 5 - 5.2 mm; plain; snap-on type; light green	 <a href="#">Item No.: 793-5501/000-012</a> WMB marking card; as card; for terminal block width 5 - 17.5 mm; stretchable 5 - 5.2 mm; plain; snap-on type; orange	 <a href="#">Item No.: 793-5501/000-005</a> WMB marking card; as card; for terminal block width 5 - 17.5 mm; stretchable 5 - 5.2 mm; plain; snap-on type; red	 <a href="#">Item No.: 793-5501/000-024</a> WMB marking card; as card; for terminal block width 5 - 17.5 mm; stretchable 5 - 5.2 mm; plain; snap-on type; violet
 <a href="#">Item No.: 793-5501</a> WMB marking card; as card; for terminal block width 5 - 17.5 mm; stretchable 5 - 5.2 mm; plain; snap-on type; white	 <a href="#">Item No.: 793-5501/000-002</a> WMB marking card; as card; for terminal block width 5 - 17.5 mm; stretchable 5 - 5.2 mm; plain; snap-on type; yellow	 <a href="#">Item No.: 793-501/000-006</a> WMB marking card; as card; not stretchable; plain; snap-on type; blue	 <a href="#">Item No.: 793-501/000-007</a> WMB marking card; as card; not stretchable; plain; snap-on type; gray

1.2.5.1 Marker



**Item No.: 793-501/000-023**  
WMB marking card; as card; not stretchable; plain; snap-on type; green



**Item No.: 793-501/000-017**  
WMB marking card; as card; not stretchable; plain; snap-on type; light green



**Item No.: 793-501/000-012**  
WMB marking card; as card; not stretchable; plain; snap-on type; orange



**Item No.: 793-501/000-005**  
WMB marking card; as card; not stretchable; plain; snap-on type; red



**Item No.: 793-501/000-024**  
WMB marking card; as card; not stretchable; plain; snap-on type; violet



**Item No.: 793-501**  
WMB marking card; as card; not stretchable; plain; snap-on type; white



**Item No.: 793-501/000-002**  
WMB marking card; as card; not stretchable; plain; snap-on type; yellow



**Item No.: 2009-115/000-006**  
WMB-Inline; for Smart Printer; 1500 pieces on roll; stretchable 5 - 5.2 mm; plain; snap-on type; blue



**Item No.: 2009-115/000-007**  
WMB-Inline; for Smart Printer; 1500 pieces on roll; stretchable 5 - 5.2 mm; plain; snap-on type; gray



**Item No.: 2009-115/000-023**  
WMB-Inline; for Smart Printer; 1500 pieces on roll; stretchable 5 - 5.2 mm; plain; snap-on type; green



**Item No.: 2009-115/000-017**  
WMB-Inline; for Smart Printer; 1500 pieces on roll; stretchable 5 - 5.2 mm; plain; snap-on type; light green



**Item No.: 2009-115/000-012**  
WMB-Inline; for Smart Printer; 1500 pieces on roll; stretchable 5 - 5.2 mm; plain; snap-on type; orange



**Item No.: 2009-115/000-024**  
WMB-Inline; for Smart Printer; 1500 pieces on roll; stretchable 5 - 5.2 mm; plain; snap-on type; violet



**Item No.: 2009-115**  
WMB-Inline; for Smart Printer; 1500 pieces on roll; stretchable 5 - 5.2 mm; plain; snap-on type; white



**Item No.: 2009-115/000-002**  
WMB-Inline; for Smart Printer; 1500 pieces on roll; stretchable 5 - 5.2 mm; plain; snap-on type; yellow

1.2.5.2 Marking strip



**Item No.: 709-196**  
Marking strips; for laser printer; translucent



**Item No.: 709-177**  
Marking strips; on reel; 7.5 mm wide; not stretchable; plain; snap-on type; translucent



**Item No.: 709-178**  
Marking strips; on reel; 7.5 mm wide; not stretchable; plain; snap-on type; white

1.2.6 Tool

1.2.6.1 Operating tool



**Item No.: 210-720**  
Operating tool; Blade: 3.5 x 0.5 mm; with a partially insulated shaft; multicoloured



**Item No.: 210-657**  
Operating tool; Blade: 3.5 x 0.5 mm; with a partially insulated shaft; short; multicoloured

Installation Notes

Commoning



Inserting a jumper.

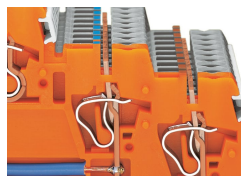

Commoning a supply voltage using uninsulated push-in type jumper bars, 2- to 9-way or 17-way (2 x 8 bits), depending on application.



Commoning signal level voltage via insulated push-in type jumper bars (870 Series) – 2- to 9-way, depending on application.  
**Sensor LED terminal blocks cannot be commoned!**

Marking



Marking strip (Item No. 709-196)

**Not suitable for LED terminal blocks!**