



Presence detector
353-750021



4 year warranty

- EN** Presence detector P46LR, DALI-2, secondary and BMS, 32-37 m, 360°, for flush-mounting box
- NL** Aanwezigheidsmelder P46LR, DALI-2, secundair en BMS, 32-37 m, 360°, voor inbouwdoos
- FR** Détecteur de présence P46LR, DALI-2, secondaire et BMS, 32-37 m, 360°, pour boîte d'encastrement
- DE** Präsenzmelder P46LR, DALI-2, Sekundär und BMS, 32-37 m, 360°, für Unterputzdose
- DK** Tilstedeværelsessensor P46LR, DALI-2, sekundær og BMS, 32-37 m, 360°, til indbygningsdåse
- SE** Närvarosensor P46LR, DALI-2, sekundär och BMS, 32-37 m, 360°, för infälld dosa
- NO** Tilstedeværelsessensor P46LR, DALI-2, sekundær og BMS, 32-37 m, 360°, til innfelt monteringsboks
- IT** Rilevatore di presenza P46LR, DALI-2, secondario e BMS, 32-37 m, 360°, per scatola da incasso
- PL** Czujnik obecności P46LR, DALI-2, drugorzędne i BMS, 32-37m, 360°, do montażu w puszcze podtynkowej
- SK** Detektor prítomnosti P46LR, DALI-2, podružný a BMS, 32-37 m, 360°, na montáž do zapustenej montážnej krabice

Installation ⚠️ 230 V/DALI power - OFF

Instalatie / Installation / Installation / Installation / Installation / Installasjon / Installazione / Instalacja / Instalácia

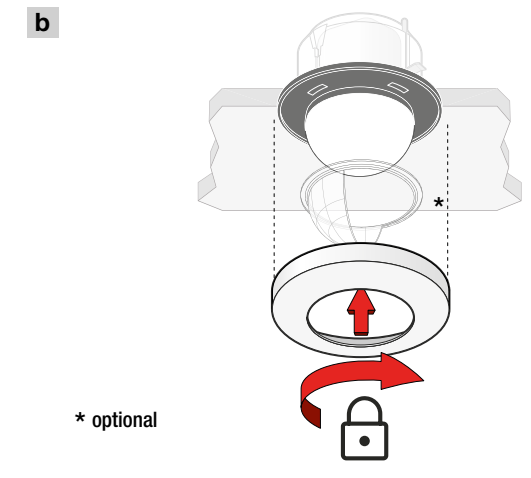
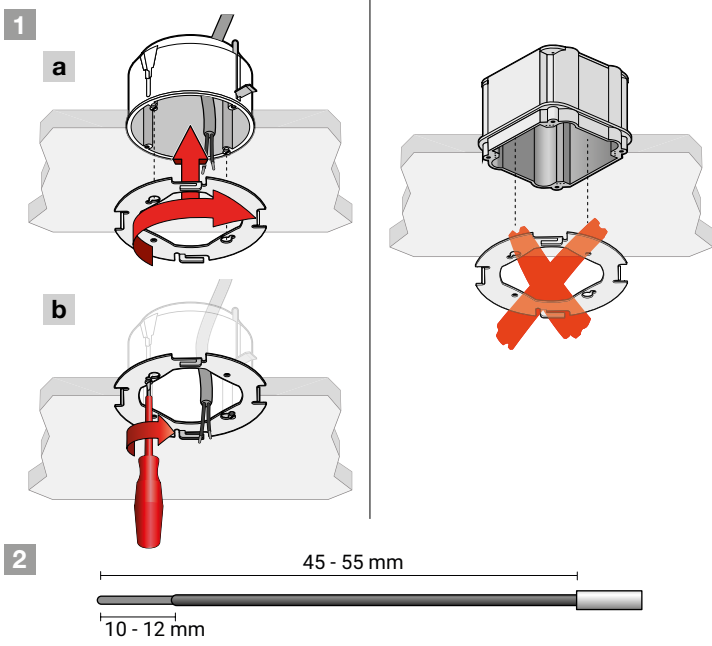
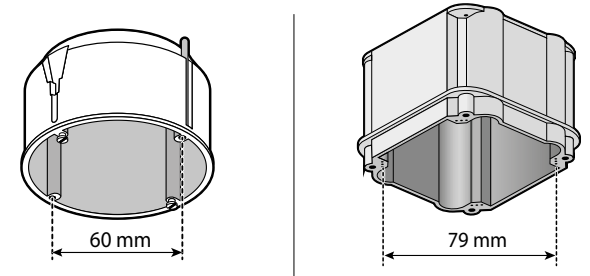

App settings ⚠️ 230 V/DALI power - ON

App-instellingen / Réglages de l'appli / App-Einstellungen / App-instillinger / Appställningar / App-innstillinger / Impostazioni dell'app / Ustawienia aplikacji / Nastavenia aplikácie

Factory Settings	Sensitivity
	High

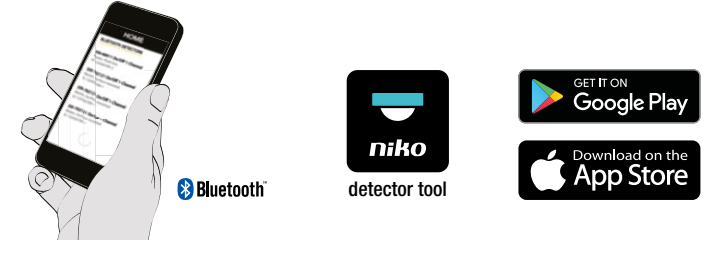

Settings by BMS software ⚠️ DALI power - ON

DALI BMS-instellingen / Réglages DALI BMS / DALI BMS Einstellungen / DALI BMS indstillinger / DALI BMS-Appställningar / DALI BMS-innstillinger / Impostazioni DALI BMS / Ustawienia DALI BMS / Nastavenia DALI BMS

Table memory bank 2			
Address	Description	Default value	Memory type
0x00	Address and last accessible memory location	0x03	ROM
0x01	Indicator byte (manufacture definable)	0x00	any
0x02	Memory bank lock byte (◊ 0x55 = Read Only else Read/ Write)	0xFF	RAM
0x03	PIR sensitivity segment A (MR, LR and HC detectors) 4 = MAX 3 = HIGH 2 = LOW 1 = MIN 0 = OFF	0x03	NVM
0x04	PIR sensitivity segment B (LR and HC detectors) 4 = MAX 3 = HIGH 2 = LOW 1 = MIN 0 = OFF	0x03	NVM
0x05	PIR sensitivity segment C (LR and HC detectors) 4 = MAX 3 = HIGH 2 = LOW 1 = MIN 0 = OFF	0x03	NVM
0x06	LUX range 0 = NORMAL 0 - 1023 lux, 10-bit 1 = HIGH 0 - 10360 lux, 14 bit	0x00	NVM

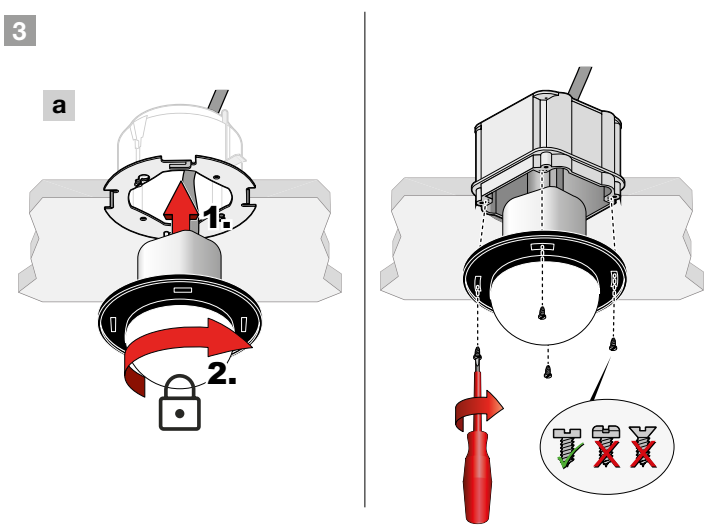
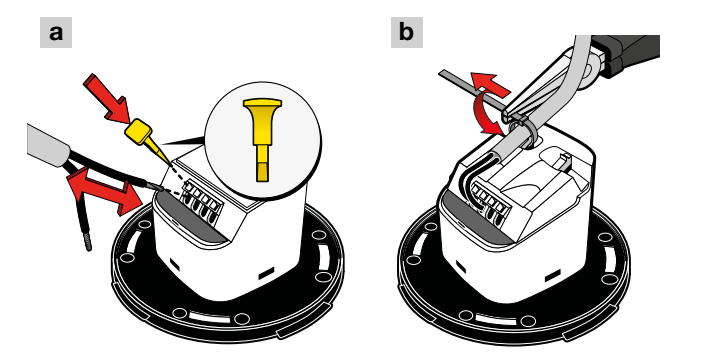

Wiring ⚠️ 230 V/DALI power - OFF

Aansluitschema / Schéma de raccordement / Verdrahtung / Tilslutningsskema / Kopplingschema / Ledningstilkopling / Cablaggio / Okablowanie / Instalácia

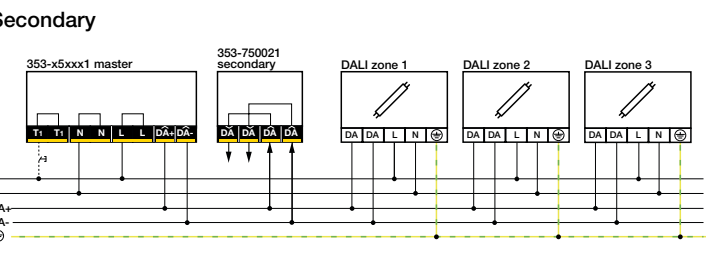

Dimensions

Afmetingen / Dimensions / Abmessungen / Dimensioner / Mått / Dimensjoner / Dimensioni / Wymiary / Rozmery

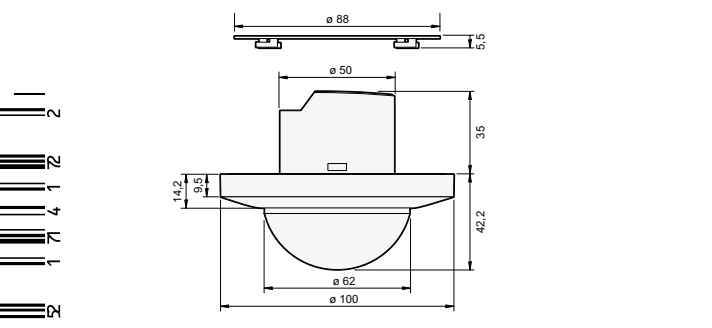

LED behaviour ⚠️ 230 V/DALI power - ON

Ledgedrag / Comportement des LED / LED-Verhalten / LED funktioner / LED-funktioner / LED-funksjon / Comportamento del LED / Zachowanie LED / LED signalizácia

EN			
Green LED continuous on	●	Connection OK	
Green LED flashing	⚡	Warming up	Wait
Red LED continuous on	●	Error	More info -->
Red LED flashing	⚡	The detector has detected an error, please check the app notifications for more information	
Blue LED flashing	⚡	Walk test active	

NL			
Groene led brandt	●	Verbinding OK	
Groene led knippert	⚡	Warmt op	Even geduld
Rode led brandt	●	Fout	Meer informatie -->
Rode led knippert	⚡	De detector heeft een fout vastgesteld, ga naar de meldingen in de app voor meer informatie	
Blauwe led knippert	⚡	Wandeltest geactiveerd	

FR			
LED verte allumée en continu	●	Connexion OK	
LED verte clignote	⚡	Chauffe	Attendez
LED rouge allumée en continu	●	Erreur	Plus d'info -->
LED rouge clignote	⚡	Le capteur a détecté une erreur, veuillez consulter les notifications de l'appli pour plus d'informations	
LED bleue clignote	⚡	Test de mouvement actif	

DE			
Grüne LED leuchtet	●	Verbindung OK	
Grüne LED blinkt	⚡	Aufwärmen	Warten
Rote LED leuchtet	●	Fehler	Mehr Info -->
Rote LED blinkt	⚡	Der Melder hat einen Fehler erkannt, weitere Informationen finden Sie in den App-Benachrichtigungen	
Blaue LED blinkt	⚡	Bewegungstest aktiv	

DK			
Grøn LED lyser konstant	●	Forbindelse OK	
Grøn LED blinker hurtigt	⚡	Värmer op	Vent
Rød LED lyser konstant	●	Fejl	Mer info -->
Rød LED blinker hurtigt	⚡	Sensoren har registreret en fejl. Se notifikationerne i appen for at få flere oplysninger	
Blå LED blinker hurtigt	⚡	Gå-test aktiv	

SE			
Grøn LED kontinuerligt på	●	Anslutning OK	
Grøn LED blinkar	⚡	Värmer upp	Vänta
Röd LED kontinuerligt på	●	Fel	Mer information -->
Röd LED blinkar	⚡	Sensorn har detekterat ett fel, kontrollera appviseringarna för mer information	
Blå LED blinkar	⚡	Promenadstest aktivt	

Grønn lysdiode kontinuerlig på	●	<i>Tilkopling OK</i>	
Grønn lysdiode blinker	☀	<i>Varmes opp</i>	<i>Vent</i>
Rød lysdiode kontinuerlig på	●	<i>Feil</i>	<i>Mer info --></i>
Rød lysdiode blinker	☀	<i>Sensoren har oppdaget en feil. Sjekk apparvarslingene for mer informasjon</i>	
Blå lysdiode blinker	☀	<i>Funksjonstest virksom</i>	

IT

LED verde sempre acceso	●	<i>Connessione OK</i>	
LED verde lampeggiante	☀	<i>Riscaldamento</i>	<i>Attendere</i>
LED rosso sempre acceso	●	<i>Errore</i>	<i>Ulteriore info --></i>
LED rosso lampeggiante	☀	<i>Il rilevatore ha riscontrato un errore, controllare le notifiche dell'app per maggiori informazioni</i>	
LED blu lampeggiante	☀	<i>Test di camminare</i>	

PL

Zielona dioda LED świeci światłem ciągłym	●	<i>Połączenie OK</i>	
Zielona dioda LED miga	☀	<i>Rozgrzewanie</i>	<i>Czekaj</i>
Czerwona dioda LED świeci światłem ciągłym	●	<i>Błąd</i>	<i>Więcej informacji --></i>
Czerwona dioda LED miga	☀	<i>Czujnik wykrył błąd, sprawdź powiadomienia aplikacji, aby uzyskać więcej informacji</i>	
Niebieska dioda LED miga	☀	<i>Test przejścia aktywny</i>	

SK

Zelená LED kontrolka svieti	●	<i>Pripojenie OK</i>	
Zelená LED kontrolka bliká	☀	<i>Zahrievanie</i>	<i>Počkajte</i>
Červená LED svieti	●	<i>Chyba</i>	<i>Viac informácií --></i>
Červená LED bliká	☀	<i>Detektor zaznamenal chybu. Viac informácií nájdete v hlásení aplikácie</i>	
Modrá LED bliká	☀	<i>Test chodenia je aktívny</i>	

Specifications

Specificaties / Specifications / Spezifikationen / Specifikationer / Specifikationer / Spesifikasjoner / Specifiche / Specyfikacje / Technické údaje

Article number	353-750021
Configuration	DALI-2 secondary/BMS
Input voltage	via the DALI bus
Maximum current consumption	28.1 mA
Nominal current consumption (12 V, 25°C)	8.1 mA
Maximum startup time DALI	< 1200 ms
Maximum PIR detection startup time	70 s
Light intensity range	0 – 10360 lux (see DALI BMS settings)
Detection angle	360°
Detection range (PIR)	ø 37 m from a height of 3 m
Ambient temperature	-25 – +40 °C
Mounting method	flush-mounting box
Mounting height	2 – 3.5 m

Colour	white (RAL 9010)
Dimensions visible (HxWxD)	100 x 100 x 42.2 mm
Dimensions (HxWxD)	100 x 100 x 77.2 mm
Wire capacity	1.5/2.5 mm²
Protection degree	IP20
Impact resistance	IK04
Modification of settings	app (iOS/Android) and 2-way Bluetooth® communication/BMS software
Maximum range Bluetooth® (free field, depending on the device)	25 m
Operating frequency	2.4 GHz
Maximum radio frequency power	-2 dBm
Halogen-free	yes
Marking	CE

Detection area

Detectieberek / Portée de détection / Erfassungsbereich / Rækkevidde / Detekteringsområde / Övervakningsområde / Campo di rilevamento / Obszar wykrywania / Oblast snimania

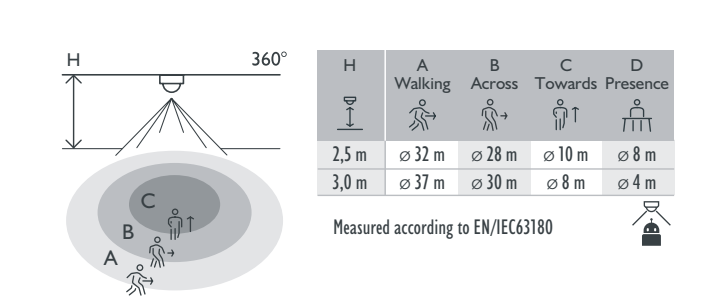

Troubleshooting

Probleemoplossing / Résolution des problèmes / Fehlerbehebung / Fejlfinding / Felsökning / Feilsøking / Risoluzione dei problemi / Rozwiązywanie problemów / Pomoc a podpora

EN		
<i>Problem</i>	<i>Possible cause</i>	<i>Proposed solution</i>
Load does not turn on	The wiring is not correct	Check the wiring scheme
Load does not turn off	The detector receives false triggers	Check for any objects that may cause false triggering and remove them from the detection range or lower the sensitivity
App cannot connect to the detector	Bluetooth® has been disabled on your mobile device	Enable Bluetooth® on your mobile device

NL

<i>Probleem</i>	<i>Mogelijke oorzaak</i>	<i>Voorgestelde oplossing</i>
De belasting schakelt niet in	De bedrading is niet correct aangesloten	Raadpleeg het aansluitschema
De belasting schakelt niet uit	De detector ontvangt valse triggers	Controleer of er in het detectiegebied objecten aanwezig zijn die valse triggers kunnen veroorzaken en verwijder deze of verlaag de gevoeligheid
De app kan geen verbinding maken met de detector	Bluetooth® is gedeactiveerd op je mobiel toestel	Activeer Bluetooth® op je mobiel toestel

FR

<i>Problème</i>	<i>Cause possible</i>	<i>Solution proposée</i>
La charge ne s'active pas	Le câblage n'est pas raccordé correctement.	Consultez le schéma de raccordement
La charge ne se désactive pas	Le détecteur reçoit de faux déclenchements	Vérifiez si des objets pouvant causer de faux déclenchements sont présents dans la zone de détection et éliminez-les ou diminuez la sensibilité
L'appli ne trouve pas le détecteur	Bluetooth® désactivé sur votre smartphone	Activez Bluetooth® sur votre smartphone

DE

<i>Problem</i>	<i>Mögliche Ursache</i>	<i>Lösungsvorschlag</i>
Das Licht schaltet sich nicht ein	Die Verdrahtung wurde nicht richtig angeschlossen	Richten Sie sich nach dem Anschlussplan
Das Licht schaltet sich nicht aus	Der Detektor empfängt falsche Signale	Kontrollieren Sie, ob sich Gegenstände im Erfassungsbereich befinden, die die Ursache für falsche Signale sein können und entfernen Sie diese oder senken Sie die Empfindlichkeit des Melders
Die App kann keine Verbindung herstellen	Bluetooth® ist auf Ihrem mobilen Gerät deaktiviert	Aktivieren Sie Bluetooth® auf Ihrem mobilen Gerät

DK

<i>Problem</i>	<i>Mulig årsag</i>	<i>Løsningsforslag</i>
Belastning tænder ikke	Fortrådning er ikke korrekt	Check tilslutningsskema
Belastning slukker ikke	Sensoren fejltændinger	Kontroller for genstande, der kan forårsage fejltænding og fjern dem fra detekteringsområdet eller minimere følsomheden
App kan ikke få forbindelse til sensoren	Bluetooth® er blevet deaktiveret på din mobile enhed	Aktiver Bluetooth® på din mobile enhed

SE

<i>Problem</i>	<i>Möjlig orsak</i>	<i>Föreslagen lösning</i>
Belastningen slås inte på	Ledningsdragnigen är inte korrekt	Kontrollera kopplingsschemat
Belastningen stängs inte av	Detektorn tar emot falsklarm	Kontrollera om något objekt kan utlösa falsklarm och ta bort dem från detektionsområdet eller sänk känsligheten
Appen kan inte ansluta till detektorn	Bluetooth® har inaktiverats på din mobila enhet	Aktivera Bluetooth® på din mobila enhet

NO

<i>Problem</i>	<i>Mulig årsak</i>	<i>Løsningsforslag</i>
Strømforsyningen koples ikke på	Ledningstilkoplingen er ikke riktig utført	Sjekk koplingskjemaet
Strømforsyningen koples ikke ut	Sensoren mottar falske triggerere	Kontroller alle gjenstander som kan forårsake falske triggerere, og fjern dem fra overvåkningsområdet eller reduser følsomhet
App kan ikke tilkoples sensoren	Bluetooth® har blitt deaktivert på mobilenheten din	Aktiver Bluetooth® på mobilenheten din

IT

<i>Problema</i>	<i>Possibile causa</i>	<i>Soluzione proposta</i>
Il carico non si accende	Il collegamento elettrico è errato	Controllare lo schema elettrico

Il carico non si spegne	Il rilevatore riceve inneschi errati	Verificare la presenza di oggetti che potrebbero innescare attivazioni errate e rimuoverli dal campo di rilevamento o abbassare la sensibilità.
La app non riesce a connettersi al rilevatore	Il Bluetooth® è stato disabilitato sul dispositivo mobile	Abilitare il Bluetooth® sul dispositivo mobile

PL

<i>Problem</i>	<i>Możliwa przyczyna</i>	<i>Proponowane rozwiązanie</i>
Obciążenie nie włącza się.	Okablowanie nie jest prawidłowe.	Sprawdź schemat okablowania.
Obciążenie się nie wyłącza	Detektor otrzymuje fałszywe wyzwalacze.	Sprawdź, czy jakiegokolwiek objekty nie powodują fałszywego wyzwalania i usuń je z zakresu wykrywania lub zmniejsz czułość.
Aplikacja nie może połączyć się z wykrywaczem.	Bluetooth® został wyłączony w urządzeniu mobilnym.	Włącz Bluetooth® na urządzeniu mobilnym.

SK

<i>Problém</i>	<i>Možná príčina</i>	<i>Navrhované riešenie</i>
Svetlo sa nezapne	Detektor nie je správne zapojený	Skontrolujte schému zapojenia
Svetlo sa nevypne	Detektor prijíma falošné spúšťače	Skontrolujte akékoľvek objekty, ktoré môžu spôsobiť falošné spustenie a odstráňte ich z detegovanej oblasti, alebo znížte citlivosť
Aplikácia sa nevie pripojiť k detektoru	Na vašom mobilnom zariadení je vypnutý Bluetooth®	Zapnite Bluetooth® na vašom mobilnom zariadení

Support & contact

nv Niko sa Industriepark West 40 9100 Sint-Niklaas, Belgium

EN	+32 3 778 90 80	support@niko.eu
NL	België: +32 3 778 90 80 <p>Nederland: +31 880 15 96 10</p>	support.be@niko.eu <p>support.nl@niko.eu</p>
FR	Belgique: +32 3 778 90 80 <p>France: +33 820 20 66 25</p> <p>Suisse: +41 44 878 22 22</p>	support.be@niko.eu <p>support.fr@niko.eu</p> <p>support.ch@niko.eu</p>
DE	Deutschland: +49 7623 96697-0 <p>Schweiz: +41 44 878 22 22</p> <p>Österreich: +43 1 7965514</p> <p>Belgien: +32 3 778 90 80</p>	support.de@niko.eu <p>support.ch@niko.eu</p> <p>support.at@niko.eu</p> <p>support.be@niko.eu</p>
DK	+45 74 42 47 26	support.dk@niko.eu
SE	+46 8 410 200 15	support.se@niko.eu
NO	+47 66 77 57 50	support.no@niko.eu
IT	+41 44 878 22 22	support.ch@niko.eu
PL	+48 509 378 373	support.pl@niko.eu
SK	+421 2 63 825 155	support.sk@niko.eu

Niko prepares its manuals with the greatest care and strives to make them as complete, correct and up-to-date as possible. Nevertheless, some deficiencies may subsist. Niko cannot be held responsible for this, other than within the legal limits. Please inform us of any deficiencies in the manuals by contacting Niko customer services at support@niko.eu.