

Data Sheet | Item Number: 788-616

Relay module; Nominal input voltage: 230 VAC; 2 changeover contacts; Limiting continuous current: 8 A; with gold contacts; Red status indicator; Module width: 15 mm; 2,50 mm²; gray

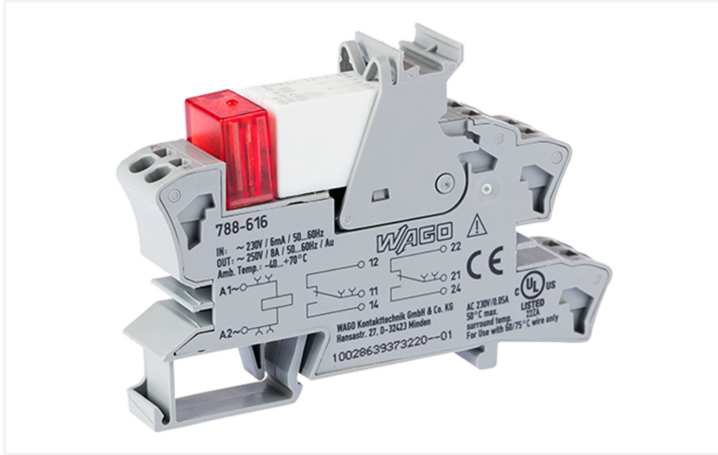

<https://www.wago.com/788-616>



Color: ■ gray

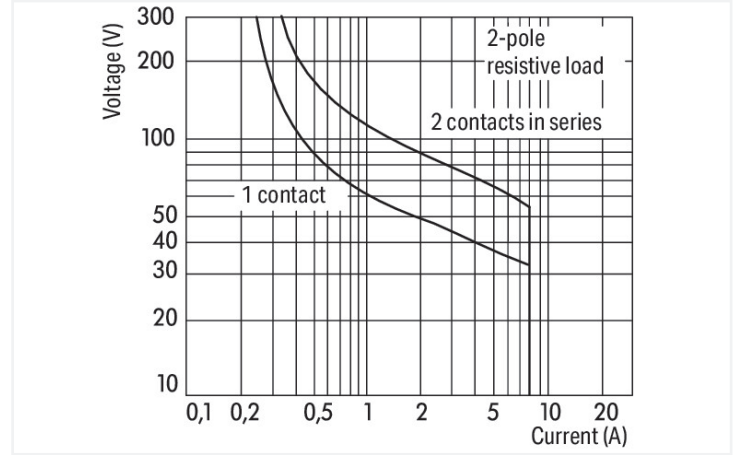

DC load limit curve

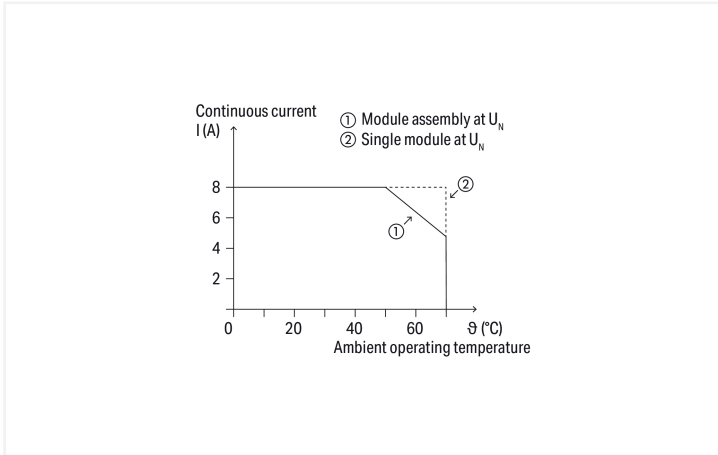

Current-carrying capacity curve

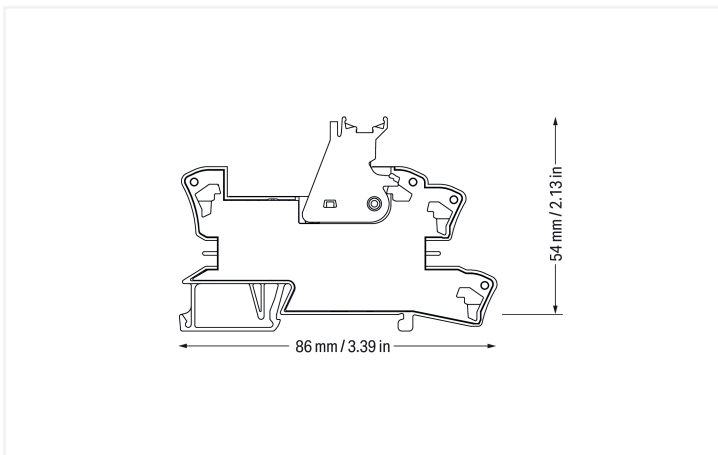
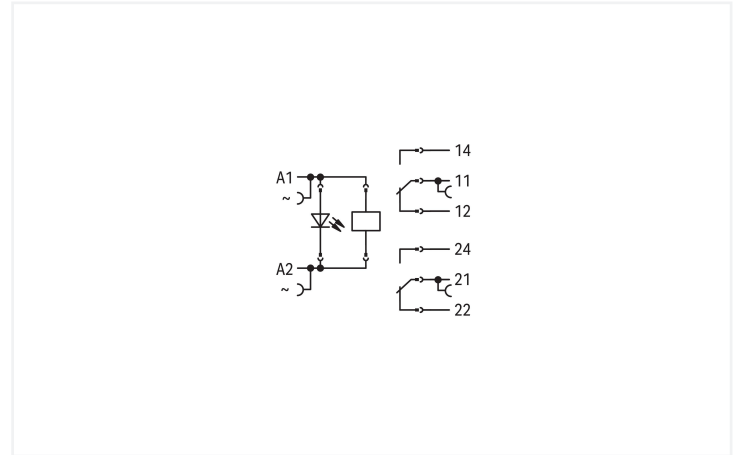

Notes

Safety Information	A separator plate (e.g., 209-191) must be used for voltages exceeding 250 V between adjacent relay modules and to comply with reinforced insulation requirements.
Note	Reinforced insulation between coil and contacts To prevent damaging the gold layer, 30 VDC switching voltages and 50 mA currents must not be exceeded. Higher switching power eventually evaporates the gold layer. The resulting deposits in the housing may reduce service life. To protect the relay coils and contacts, inductive loads must be dampened with an effective protection circuit.

Technical data

Control circuit

Nominal input voltage U_N	230 VAC
Input voltage range	$\pm 10\%$
Nominal input current at U_N	5 mA

Load circuit

Number of changeover/switchover contacts	2
Contact material (relay)	AgNi + Au
Limiting continuous current	8 A
Switching Voltage, Max.	250 VAC
Switching power (resistive) max.	AC 2000 VA; DC (see load limit curve)
Switching capacity	AC-15: 3 A / 250 VAC; DC-13: 2 A / 24 VDC
Recommended minimum load	5 V / 2 mA / 50 mW
Pull-in time (typ.)	7 ms
Drop-out time (typ.)	3 ms
Electrical life (NO; resistive load; 23 °C)	100 x 10 ³ switching operations
Mechanical life	30 x 10 ⁶ switching operations

Signaling

Status indicator	Red LED
------------------	---------

Safety and protection

Rated Voltage	250 V
Rated impulse withstand voltage	4 kV
Pollution degree	3
Dielectric strength (control/load circuit) (AC, 1 min)	5 kVrms
Dielectric strength (open contact) (AC, 1 min)	1 kVrms
Dielectric strength (load/load circuit) (AC, 1 min)	2.5 kVrms
Safety Information	A separator plate (e.g., 209-191) must be used for voltages exceeding 250 V between adjacent relay modules and to comply with reinforced insulation requirements.
Protection type	IP20

Connection Data

Connection technology	Push-in CAGE CLAMP®
Solid conductor	0.34 ... 2.5 mm ² / 22 ... 14 AWG
Fine-stranded conductor	0.34 ... 2.5 mm ² / 22 ... 14 AWG
Strip length	9 ... 10 mm / 0.35 ... 0.39 inches

Physical data

Width	15 mm / 0.591 inches
Height	86 mm / 3.386 inches
Depth from upper-edge of DIN-rail	54 mm / 2.126 inches

Mechanical data

Mounting type	DIN-35 rail
---------------	-------------

Material data

Note (material data)	Information on material specifications can be found here
Color	gray
Fire load	0.836 MJ
Weight	45.5 g

Environmental requirements

Ambient temperature (operation at U_N)	-40 ... +70 °C
Ambient temperature UL (operation at U_N)	-40 ... +50 °C
Ambient temperature (storage)	-40 ... +70 °C
Processing temperature	-25 ... +50 °C
Temperature range of connection cable	$\geq (T_{\text{ambient}} + 20 \text{ K})$

Standards and Specifications

Standards/specifications	EN 61010-2-201 EN 61810-1 EN 61373 UL 508 DNV
--------------------------	---

Basic relay

WAGO Basic Relay	788-181
------------------	---------

Commercial data

Product Group	6 (INTERFACE ELECTRONIC)
PU (SPU)	20 (1) pcs
Packaging type	Box
Country of origin	DE
GTIN	4045454484804
Customs tariff number	85364900990

Product Classification

UNSPSC	39122334
eCl@ss 10.0	27-37-16-01
eCl@ss 9.0	27-37-16-01
ETIM 9.0	EC001437
ETIM 10.0	EC001437
ECCN	NO US CLASSIFICATION

Environmental Product Compliance

CAS-No.	7439-92-1 79-94-7
REACH Candidate List Substance	2,2',6,6'-tetrabromo-4,4'-isopropylidenediphenol Lead
RoHS Compliance Status	Compliant,With Exemption
RoHS Exemption	7(a)
SCIP notification number (Austria)	bfc78d36-341b-4994-8bed-6d06407fb230
SCIP notification number (Belgium)	88178c2e-c698-4af1-90fb-63cc9fe3f887
SCIP notification number (Bulgaria)	ad587133-d792-4fba-aaa0-bd131c5590c4
SCIP notification number (Czech Republic)	5a63a325-14b9-4a2b-838d-a21bde620399
SCIP notification number (Denmark)	1f2dfa1f-e9fd-4cab-a5bd-5e7a4e0c98f8
SCIP notification number (Finland)	98a7faef-09e0-4019-93fb-1be5cee850f7
SCIP notification number (France)	83fdb6e4-8ff7-4c68-93ac-4c2e1506072d
SCIP notification number (Germany)	c0cdad25-4481-48fa-8907-42d8151e903d
SCIP notification number (Hungary)	d7fd6b1d-b3a1-4a00-9feb-3ffe54adb73c
SCIP notification number (Italy)	4c6bc921-2d10-4107-bdb5-b820ac523822
SCIP notification number (Netherlands)	3e5988b1-bc33-40f6-9832-2b78347052c7
SCIP notification number (Poland)	a7a12ae5-d9d0-495b-907b-e3ab130a3a5b
SCIP notification number (Romania)	45902eec-11c3-4ba9-bb29-bad7bcb8a8e8
SCIP notification number (Sweden)	d77c0d90-a2c6-4f7d-9afd-df5943db75be

Approvals / Certificates

General approvals **Declarations of conformity and manufacturer's declarations**



Approval	Standard	Certificate Name
EAC GZO Almaty Standart	TP TC 004/2011	EAC CoC 03084
UL Underwriters Laboratories Inc. (ORDINARY LOCATIONS)	UL 508	E175199 Vol.1 Sec.6

Approval	Standard	Certificate Name
EU-Declaration of Conformity WAGO GmbH & Co. KG	-	-
UK-Declaration of Conformity WAGO GmbH & Co. KG	-	-

Approvals for marine applications



Approval	Standard	Certificate Name
DNV DNV Germany GmbH	DNV-CG-0339, Aug.2021	TAA00001D1

Downloads

Environmental Product Compliance

Compliance Search	
Environmental Product Compliance 788-616	↓

Documentation

Bid Text			
788-616	19.02.2019	xml 4.94 KB	↓
788-616	25.01.2019	docx 16.64 KB	↓

Instruction Leaflet			
Sockets with Elementary Relay/ SSR	V 1.0.1 09.10.2020	pdf 2271.22 KB	↓

CAD/CAE-Data

CAD data	
2D/3D Models 788-616	↓

CAE data	
EPLAN Data Portal 788-616	↓
WSCAD Universe 788-616	↓
ZUKEN Portal 788-616	↓

1 Compatible Products

1.1 Optional Accessories

1.1.1 Basic relay

1.1.1.1 Basic relay



Item No.: 788-181
 Basic relay; Nominal input voltage: 230 VAC; 2 changeover contacts; Limiting continuous current: 8 A; with gold contacts; Module width: 13 mm; Module height: 15 mm

1.1.2 Ferrule

1.1.2.1 Ferrule



Item No.: 216-241
 Ferrule; Sleeve for 0.5 mm² / 20 AWG; insulated; electro-tin plated; electrolytic copper; gastight crimped; acc. to DIN 46228, Part 4/09.90; white



Item No.: 216-242
 Ferrule; Sleeve for 0.75 mm² / 18 AWG; insulated; electro-tin plated; electrolytic copper; gastight crimped; acc. to DIN 46228, Part 4/09.90; gray



Item No.: 216-243
 Ferrule; Sleeve for 1 mm² / AWG 18; insulated; electro-tin plated; electrolytic copper; gastight crimped; acc. to DIN 46228, Part 4/09.90; red



Item No.: 216-244
 Ferrule; Sleeve for 1.5 mm² / AWG 16; insulated; electro-tin plated; electrolytic copper; gastight crimped; acc. to DIN 46228, Part 4/09.90; black

1.1.2.1 Ferrule



Item No.: 216-542

Twin ferrule; Sleeve for 2 x 1 mm² / AWG 2 x 18; red, insulated; 12 mm long; red

1.1.3 Filter module

1.1.3.1 Suppressor module



Item No.: 788-148

Filter module; RC filter element; Nominal voltage: 230 VAC

1.1.4 Indicators

1.1.4.1 Status indication



Item No.: 788-125

Accessories for relay modules; Operation status indicator: red

1.1.5 Jumper

1.1.5.1 Jumper



Item No.: 788-118

Jumper; for jumper slot; 2-way; from 1 to 3; insulated; light gray



Item No.: 788-113

Jumper; for jumper slot; 2-way; insulated; light gray



Item No.: 859-402

Jumper; for jumper slot; 2-way; insulated; light gray



Item No.: 788-114

Jumper; for jumper slot; 3-way; insulated; light gray



Item No.: 788-115

Jumper; for jumper slot; 4-way; insulated; light gray



Item No.: 788-116

Jumper; for jumper slot; 6-way; insulated; light gray



Item No.: 788-117

Jumper; for jumper slot; 8-way; insulated; light gray

1.1.6 Marking

1.1.6.1 Double marker carrier



Item No.: 209-128

Adaptor; gray

1.1.6.2 Group marker carrier



Item No.: 249-105

Group marker carrier; gray

Item No.: 209-145

Group marker carrier; white

1.1.6.3 Marker



Item No.: 209-183

Marker; white

Item No.: 793-502

WMB marking card; as card; MARKED; 1 ... 10 (10x); not stretchable; Horizontal marking; snap-on type; white

Item No.: 793-503

WMB marking card; as card; MARKED; 11 ... 20 (10x); not stretchable; Horizontal marking; snap-on type; white

Item No.: 793-504

WMB marking card; as card; MARKED; 21 ... 30 (10x); not stretchable; Horizontal marking; snap-on type; white



Item No.: 793-505

WMB marking card; as card; MARKED; 31 ... 40 (10x); not stretchable; Horizontal marking; snap-on type; white

Item No.: 793-501

WMB marking card; as card; not stretchable; plain; snap-on type; white

Item No.: 2009-115

WMB-Inline; for Smart Printer; 1500 pieces on roll; stretchable 5 - 5.2 mm; plain; snap-on type; white

1.1.6.4 Marking device



Item No.: 210-110

Fiber-tip pen

1.1.6.5 Marking strip



Item No.: 2009-110

Marking strips; for Smart Printer; on reel; not stretchable; plain; snap-on type; white

1.1.6.6 Protective marker cover



Item No.: 209-184

Protection cover; transparent

1.1.7 Tool

1.1.7.1 Operating tool



Item No.: 210-720

Operating tool; Blade: 3.5 x 0.5 mm; with a partially insulated shaft; multicoloured

Installation Notes

Conductor termination

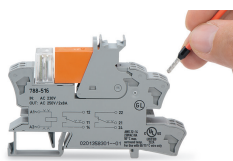

Conductor termination

Commoning

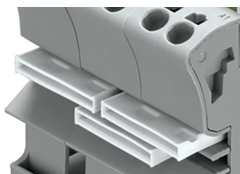

Easy commoning using adjacent jumpers

Marking



Marking using WMB Multi markers and group marker carriers.