

# Productinformatieblad

Specificaties

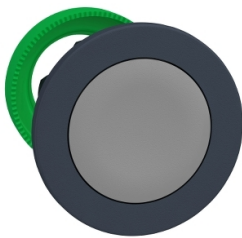

## Harmony XB5, Antimicrobiële Kop voor verzonken drukknop, Grijs

ZB5FA8

EAN Code: 3606481339164

**Prijs: 6,20 EUR**

### Hoofd

range of product	Harmony XB5
product or component type	Kop voor niet-verlichte drukknop
device short name	ZB5
compatibiliteit product	ZBYF... ZBZF32 ZBZF33 ZB5AZ
kraag materiaal	Donkergrijs kunststof
bevestigingsdiameter	30,5 mm
koptype	Built-in-flush
verkoop per ondeelbare hoeveelheid	1
vorm van kop signaleringseenheid	Rond
type operator	terugverend
operator profiel	Grijs verzonken, niet gemarkeerd

### Complementair

CAD totale breedte	37 mm
CAD totale hoogte	37 mm
CAD totale diepte	30 mm
net weight	0,03 kg
mechanical durability	10000000 cycles
elektrische samenstellingscode	C1 voor <9 contacten met enkelvoudig blokken in vooraan gemonteerd C2 voor <9 contacten met enkelvoudig en dubbel blokken in vooraan gemonteerd C11 voor <3 contacten met enkelvoudig blokken in vooraan gemonteerd C15 voor <1 contacten met enkelvoudig blokken in vooraan gemonteerd SF1 voor <3 contacten met enkelvoudig blokken in vooraan gemonteerd

### Omgeving

beschermende behandeling	TH
ambient air temperature for storage	-40...70 °C
ambient air temperature for operation	-40...70 °C
overvoltage category	Klasse II conforming to IEC 60536

De weergegeven prijs is de adviesprijs in euro excl. BTW. Deze kan onderhevig zijn aan korting. Neem contact op met uw lokale distributeur of detailhandel voor de daadwerkelijke prijs

<b>IP beschermingsgraad</b>	IP66 conform aan IEC 60529 IP67 conform aan IEC 60529 IP69 conform aan IEC 60529 IP69K conform aan ISO 20653 Type 13 conform aan UL 50 E Type 12 conform aan UL 50 E Type 4 conform aan UL 50 E Type 4X conform aan UL 50 E
<b>weerstand hoge druk drukring</b>	7000000 Pa bij 55 °C, afstand: 0.1 m
<b>IK-beschermingsgraad</b>	IK03 conforming to IEC 50102
<b>standards</b>	CSA C22.2 Nr 14 UL 508 IEC 60947-5-1 JIS C8201-5-1 IEC 60947-1 IEC 60947-5-4 JIS C8201-1 ISO 21702 ISO 22196:2011
<b>product certifications</b>	CSA DNV BV LROS (Lloyds register of shipping) UL listed
<b>schokbestendigheid</b>	30 gn (duur = 18 ms) voor halve sinusgolf versnelling conform aan IEC 60068-2-27 50 gn (duur = 11 ms) voor halve sinusgolf versnelling conform aan IEC 60068-2-27 25 gn (duur = 6 ms) voor 1000 schokken op elke as conform aan IEC 60068-2-27
<b>trilling bestendigheid</b>	5 gn (f= 10...500 Hz) conforming to IEC 60068-2-6 2 mm piek-piek (f= 2...10 Hz) conforming to IEC 60068-2-6

## Verpakkingseenheid

<b>Unit Type of Package 1</b>	PCE
<b>Number of Units in Package 1</b>	1
<b>Package 1 Height</b>	5,45 cm
<b>Package 1 Width</b>	4,3 cm
<b>Package 1 Length</b>	5,2 cm
<b>Package 1 Weight</b>	22,0 g

## contractuele waarborg

<b>Garantie</b>	18 months
-----------------	-----------

## Environmental Data

Schneider Electric wil tegen 2050 de Net Zero-status hebben bereikt via partnerschappen in de toeleveringsketen, materialen met een lagere impact en circulariteit via onze doorlopende campagne "Use Better, Use Longer, Use Again" om de levensduur van producten en de recycleerbaarheid te verlengen.

[Uitleg van Environmental Data](#) >

[Hoe evalueren we de duurzaamheid van producten?](#) >

### Milieuoetafdruk

Totale levenscyclus ecologische voetafdruk 1

Milieuprofiel van product (PEP) [Milieuprofiel van het product](#)

### Use Better

#### Materialen en verpakking

Pakket met gerecycleerd karton Ja

Verpakkingen zonder kunststof Ja

[EU-richtlijn RoHS](#)

Voldoet pro-actief (Product valt niet onder de EU RoHS juridische scope)

REACH-regelgeving

[REACH-verklaring](#)

### Use Again

#### Herverpakken en herfabriceren

Circulair Profiel [Informatie over einde levensduur](#)

Terugname No

Dimensions Drawings

Dimensions

---

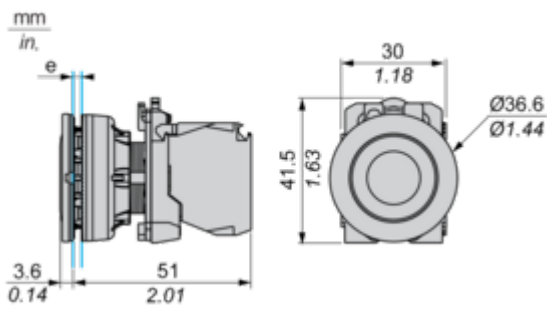

e: Clamping thickness: 1 to 6 mm / 0.04 to 0.24 in.

Mounting and Clearance

**Panel Cut-out for Pushbuttons, Switches and Pilot Lights (Finished Holes, Ready for Installation)**

---

**Connection by Screw Clamp Terminals or Plug-in Connectors**

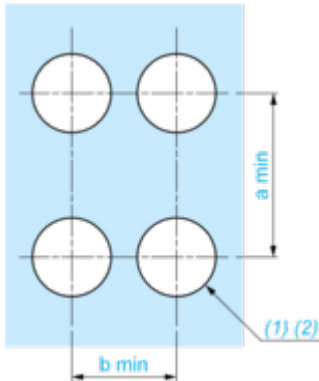

(1) Diameter on finished panel or support

(2)  $\varnothing 30.75$  mm recommended ( $\varnothing 30.5 \begin{smallmatrix} +0.5 \\ 0 \end{smallmatrix}$ ) /  $\varnothing 1.21$  in. recommended ( $\varnothing 1.20$  in.  $\begin{smallmatrix} +0.0196 \\ 0 \end{smallmatrix}$ )

Connections	a in mm	a in in.	b in mm	b in in.
By screw clamp terminals or plug-in connector	40	1.57	40	1.57
By Faston connectors	45	1.77	40	1.57

Technical Description

Electrical Composition Corresponding to Code C1

---



Electrical Composition Corresponding to Code C2

---

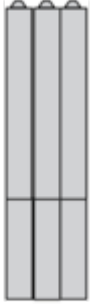

Electrical Composition Corresponding to Codes C9, C11, SF1 and SR1

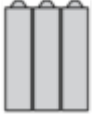

Electrical Composition Corresponding to Code C15

---

1 N/O



1 N/C

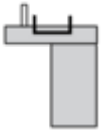

1 N/O + N/C or 1 N/O + N/O or 1 N/C + N/C

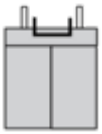

**Legend**

---

Single contact



Double contact



Light block







Possible location

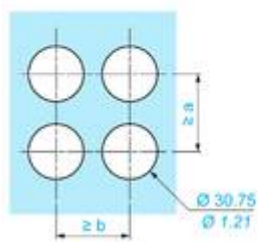
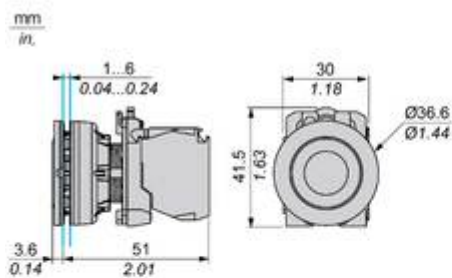

Technical Illustration

Dimensions



	a (mm)	a (in.)	b (mm)	b (in.)
 ZBE..... ZBV.....	40	1.57	40	1.57
 ZBE.....3 ZBV.....3	45	1.77	40	1.57
 ZBE.....4 ZBV.....4	40	1.57	40	1.57

Offer Marketing Illustration

Product benefits / Features





---

The infographic features a central image of three electrical components: a red pushbutton, a green illuminated pushbutton, and a selector switch. Surrounding this central image are five circular icons, each with a corresponding text block describing a feature. The background is a solid green color.

### Features

#### Harmony XB4/XB5

#### Flush mounting solution

-  Innovative and attractive design improving the look and feel of control panels and machines
-  Robustness to withstand harsh environments
-  Quick and easy installation into a standard 30mm hole
-  Available for pushbuttons, illuminated pushbuttons, pilot lights and selector switches
-  Easier to clean with towels than standard offers

Offer Marketing Illustration

Product benefits / Features

---

### Features Harmony XB5



- 

Quick and easy assembly and disassembly
- 

Excellent mechanical connection with operator head
- 

Various types of connection: screw clamp, connector, Faston connector, spring terminal, or printed circuit board
- 

Large set of accessories to customize your panels
- 

Robustness to withstand harsh environments

Offer Marketing Illustration

Product benefits / Features

---

## Technical Benefits

Harmony XB5

Conformity with IEC, UL, CSA, CCC EAC, and JIS standards, as well as CE marking and marine approvals

Up to IP66, 67, 69, 69K, and type 4X protection ratings

High vibration resistance with shake-proof terminal screws



Operating temperature from -40°C to 70°C

Shock protection level up to IK06

Secure switching of inductive or heavy DC loads directly – 100 000 operations at 10A, 24V dc

Offer Marketing Illustration

Product benefits / Features

---

## Technical Benefits

Harmony XB5

Conformity with IEC, UL, CSA, CCC EAC, and JIS standards, as well as CE marking and marine approvals

Up to IP66, 67, 69, 69K, and type 4X protection ratings

High vibration resistance with shake-proof terminal screws



Operating temperature from -40°C to 70°C

Shock protection level up to IK06

Secure switching of inductive or heavy DC loads directly – 100 000 operations at 10A, 24V dc

Offer Marketing Illustration

Product benefits / Features

---

### Features Harmony XB5



- 

Quick and easy assembly and disassembly
- 

Excellent mechanical connection with operator head
- 

Various types of connection: screw clamp, connector, Faston connector, spring terminal, or printed circuit board
- 

Large set of accessories to customize your panels
- 

Robustness to withstand harsh environments

Image of product / Alternate images

Alternative

---

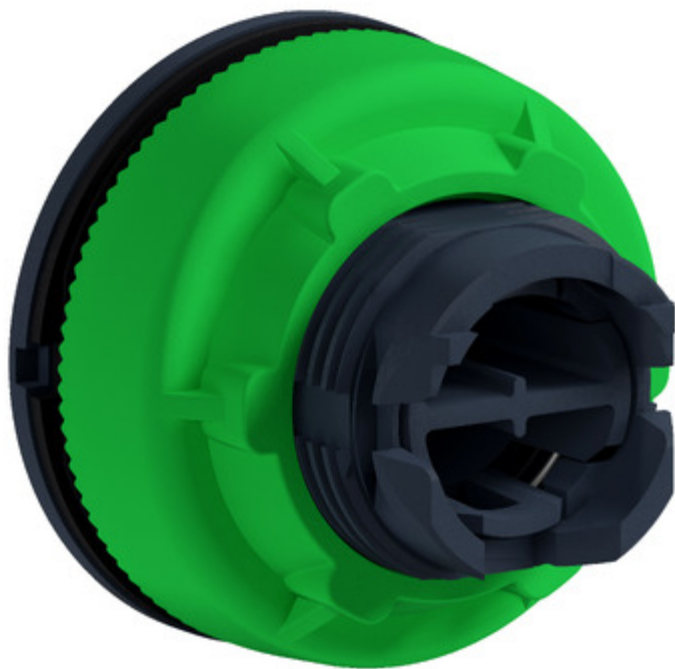



Image of product in real life situation

