

Data Sheet | Item Number: 2060-953/028-000

Board-to-Board Link; Pin spacing 4 mm; 3-pole; Length: 28 mm; white

<https://www.wago.com/2060-953/028-000>



Color: ■ white

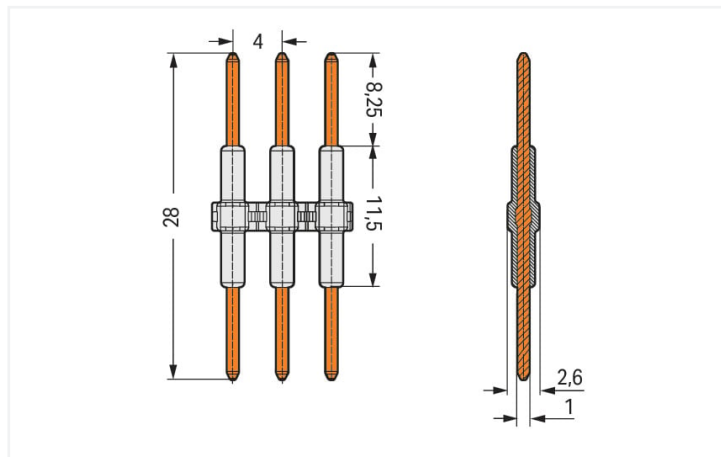

Dimensions in mm

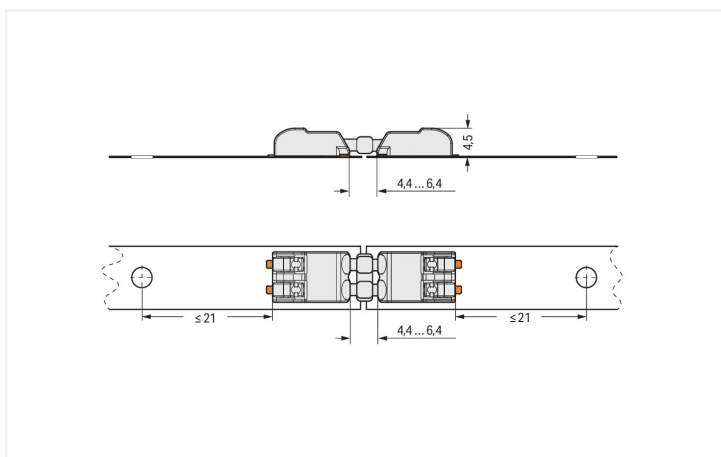

Dimensions in mm

- Board-to-board links simplify LED module assembly
- Easy push-in connection and disconnection

Notes

Safety information

Notice: Only suitable for 2060-45x, not for 2060-40x.

Electrical data

Ratings per	IEC/EN 60664-1		
Overvoltage category	III	III	II
Pollution degree	3	2	2
Nominal voltage	63 V	160 V	320 V
Rated surge voltage	2.5 kV	2.5 kV	2.5 kV
Rated current	9 A	9 A	9 A

Approvals per	UL 1977
Rated voltage	250 V
Rated current	9 A

Connection data

Total number of potentials	3	Connection 1	
		Pole number	3

Physical data

Pin spacing	4 mm / 0.157 inches
Width	11.4 mm / 0.449 inches
Height	2.6 mm / 0.102 inches
Depth	28 mm / 1.102 inches

Mechanical data

Mating cycles (max.)	10
Number of mating cycles	10 connections/disconnections (max.)
Suitable	for SMD PCB terminal blocks (2060 Series)

Material data

Note (material data)	Information on material specifications can be found here
Color	white
Material group	I
Insulation material	Polyamide (PA66)
Flammability class per UL94	V0
Contact material	Copper alloy
Contact plating	Silver
Fire load	0.004 MJ
Weight	0.7 g

Environmental requirements

Limit temperature range	-60 ... +105 °C
-------------------------	-----------------

Commercial data

eCl@ss 10.0	27-14-11-92
eCl@ss 9.0	27-14-11-92
ETIM 8.0	EC002848
ETIM 7.0	EC002848
PU (SPU)	375 pcs
Packaging type	Box
Country of origin	CN
GTIN	4055143303873
Customs tariff number	85369010000

Environmental Product Compliance

RoHS Compliance Status	Compliant, No Exemption
------------------------	-------------------------

Approvals / Certificates

General approvals



Approval	Standard	Certificate Name
CCA DEKRA Certification B.V.	EN 60947	NTR NL-7724
CCA DEKRA Certification B.V.	EN 60998	NTR NL 7725/M1
CCA DEKRA Certification B.V.	EN 60838	NTR NL 2168246
CCA DEKRA Certification B.V.	EN 60947-7-4	NTR NL 7843
cURus Underwriters Laboratories Inc.	UL 1977	E45171
KEMA/KEUR DEKRA Certification B.V.	EN 60838	2168246.01
KEMA/KEUR DEKRA Certification B.V.	EN 60947	71-108183
KEMA/KEUR DEKRA Certification B.V.	EN 60998	71-109040
KEMA/KEUR DEKRA Certification B.V.	EN 60947-7-4	71-114208
UL Underwriters Laboratories Inc.	UL 1059	E45172

Declarations of conformity and manufacturer's declarations

Approval	Standard	Certificate Name
EU-Declaration of Conformity WAGO GmbH & Co. KG	-	-
UK-Declaration of Conformity WAGO GmbH & Co. KG	-	-

Downloads

Environmental Product Compliance

Compliance Search	
Environmental Product Compliance 2060-953/028-000	↓

Documentation

Additional Information			
Technical Section	03.04.2019	pdf 2010.85 KB	↓

CAD/CAE-Data

CAD data

2D/3D Models
2060-953/028-000



CAE data

ZUKEN Portal
2060-953/028-000



Installation Notes

Installation

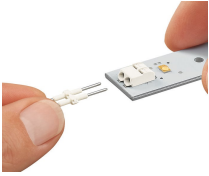

Inserting a board-to-board link into the terminal block.

Installation

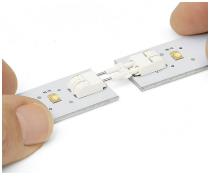

Assembly: Place PCBs on a flat surface and connect terminal blocks on adjoining PCBs via board-to-board link.
Disassembly: Pull PCBs apart (max. 10 mating cycles).

Installation

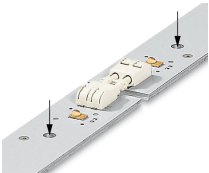

The PCBs must be secured.