

# Productinformatieblad

Specificaties

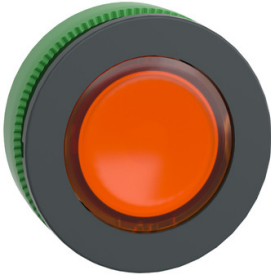

## Harmony XB5, Antimicrobiële Kop voor verzonken drukknop, Oranje, Verlicht, Led

ZB5FW353

**Belangrijk bericht:** A change in appearance may be noted on the product but does not affect its use in terms of function and safety. This makes it compatible with our Universal LED blocks  
EAN Code: 3606481339690

**Prijs: 9,76 EUR**

### Hoofd

range of product	Harmony XB5
product or component type	Kop voor verlichte drukknop
device short name	ZB5
compatibiliteit product	Universele LED
kraag materiaal	Donkergrijs kunststof
bevestigingsdiameter	30,5 mm
verkoop per ondeelbare hoeveelheid	1
koptype	Built-in-flush
vorm van kop signaleringseenheid	Rond
type operator	terugverend
operator profiel	Oranje verzonken, niet gemarkeerd
extra informatie operator	Met gewone lens

### Complementair

CAD totale breedte	37 mm
CAD totale hoogte	37 mm
CAD totale diepte	30 mm
net weight	0,017 kg
weerstand hoge druk drukkring	7000000 Pa bij 55 °C, afstand: 0.1 m
mechanical durability	10000000 cycles
kap/operator of lenskleur	Oranje
markering	Niet gemarkeerd
elektrische samenstellingscode	M1 voor <6 contacten met enkelvoudig blokken in vooraan gemonteerd met integrale LED M2 voor <6 contacten met enkelvoudig en dubbel blokken in vooraan gemonteerd met integrale LED M6 voor <2 contacten met enkelvoudig blokken in vooraan gemonteerd met ingebouwde LED en transformator M10 voor <2 contacten met enkelvoudig blokken in vooraan gemonteerd met integrale LED MF1 voor <2 contacten met enkelvoudig blokken in vooraan gemonteerd met integrale LED

**product presentatie** Basisonderdeel

De weergegeven prijs is de adviesprijs in euro excl. BTW. Deze kan onderhevig zijn aan korting. Neem contact op met uw lokale distributeur of detailhandel voor de daadwerkelijke prijs

## Omgeving

beschermende behandeling	TC
ambient air temperature for storage	-40...70 °C
ambient air temperature for operation	-40...70 °C
overvoltage category	Klasse II conforming to IEC 60536
IP beschermingsgraad	IP66 conform aan IEC 60529 IP67 IP69 IP69K
NEMA beschermingsgraad	NEMA 13 NEMA 4X
IK-beschermingsgraad	IK03 conforming to IEC 62262
standards	UL 508 JIS C8201-5-1 IEC 60947-5-4 CSA C22.2 Nr 14 GB 14048.5 IEC 60947-5-1 IEC 60947-1 JIS C8201-1 ISO 21702 ISO 22196:2011
product certifications	CSA DNV BV LROS (Lloyds register of shipping) UL listed
trilling bestendigheid	5 gn (f= 2...500 Hz) conforming to IEC 60068-2-6
schokbestendigheid	30 gn (duur = 18 ms) voor halve sinusgolf versnelling conform aan IEC 60068-2-27 50 gn (duur = 11 ms) voor halve sinusgolf versnelling conform aan IEC 60068-2-27

## Verpakkingseenheid

Unit Type of Package 1	PCE
Number of Units in Package 1	1
Package 1 Height	5,6 cm
Package 1 Width	4,3 cm
Package 1 Length	5,2 cm
Package 1 Weight	23 g
Unit Type of Package 2	S02
Number of Units in Package 2	40
Package 2 Height	15 cm
Package 2 Width	30 cm
Package 2 Length	40 cm
Package 2 Weight	1,253 kg

## Environmental Data

Schneider Electric wil tegen 2050 de Net Zero-status hebben bereikt via partnerschappen in de toeleveringsketen, materialen met een lagere impact en circulariteit via onze doorlopende campagne "Use Better, Use Longer, Use Again" om de levensduur van producten en de recycleerbaarheid te verlengen.

[Uitleg van Environmental Data](#) >

[Hoe evalueren we de duurzaamheid van producten?](#) >

### Milieuoetafdruk

Totale levenscyclus ecologische voetafdruk 1

Milieuprofiel van product (PEP) [Milieuprofiel van het product](#)

### Use Better

#### Materialen en verpakking

Pakket met gerecycleerd karton Ja

Verpakkingen zonder kunststof Ja

[EU-richtlijn RoHS](#)

Voldoet pro-actief (Product valt niet onder de EU RoHS juridische scope)

REACH-regelgeving

[REACH-verklaring](#)

### Use Again

#### Herverpakken en herfabriceren

Circulair Profiel [Informatie over einde levensduur](#)

Terugname No

Dimensions Drawings

Dimensions

---

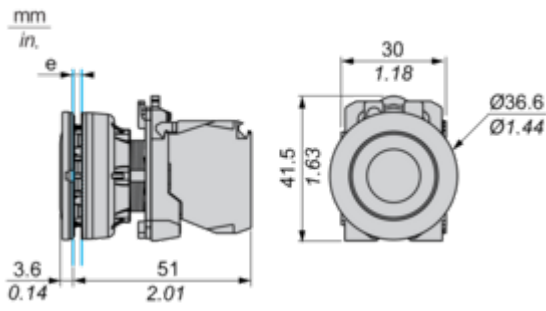

e: Clamping thickness: 1 to 6 mm / 0.04 to 0.24 in.

Mounting and Clearance

**Panel Cut-out for Pushbuttons, Switches and Pilot Lights (Finished Holes, Ready for Installation)**

---

**Connection by Screw Clamp Terminals or Plug-in Connectors**

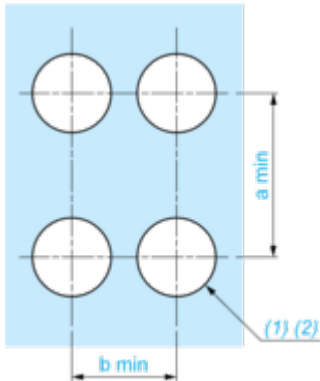

(1) Diameter on finished panel or support

(2)  $\text{Ø}30.75 \text{ mm}$  recommended ( $\text{Ø}30.5 \text{ }_0^{+0.5}$ ) /  $\text{Ø}1.21 \text{ in.}$  recommended ( $\text{Ø}1.20 \text{ in. }_0^{+0.0196}$ )

Connections	a in mm	a in in.	b in mm	b in in.
By screw clamp terminals or plug-in connector	40	1.57	40	1.57
By Faston connectors	45	1.77	40	1.57

Technical Description

Electrical Composition Corresponding to Codes M1 and M7

---

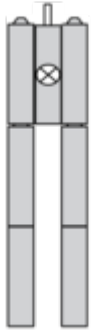

Electrical Composition Corresponding to Codes M2 and M8

---



Electrical Composition Corresponding to Codes M6 and P2

---



Electrical Composition Corresponding to Codes M5, M10, MF1, MR1 and MF2

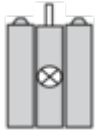

**Legend**

---

Single contact



Double contact



Light block



Possible location



Technical Illustration

Dimensions

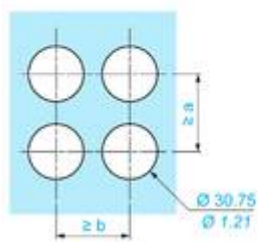
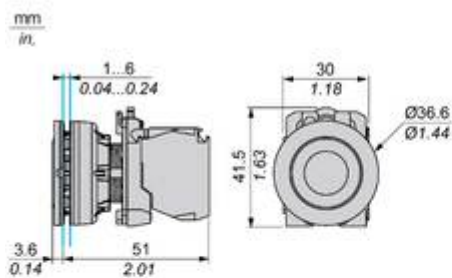

		a (mm)	a (in.)	b (mm)	b (in.)
		40	1.57	40	1.57
ZBE.....	ZBV.....				
		45	1.77	40	1.57
ZBE.....3	ZBV.....3				
		40	1.57	40	1.57
ZBE.....4	ZBV.....4				

Offer Marketing Illustration

Product benefits / Features

---

### Features Harmony XB5



- 

Quick and easy assembly and disassembly
- 

Excellent mechanical connection with operator head
- 

Various types of connection: screw clamp, connector, Faston connector, spring terminal, or printed circuit board
- 

Large set of accessories to customize your panels
- 

Robustness to withstand harsh environments

Offer Marketing Illustration

Product benefits / Features

---

## Technical Benefits

### Harmony XB5

Conformity with IEC, UL, CSA, CCC EAC, and JIS standards, as well as CE marking and marine approvals

Up to IP66, 67, 69, 69K, and type 4X protection ratings

High vibration resistance with shake-proof terminal screws



Operating temperature from -40°C to 70°C

Shock protection level up to IK06

Secure switching of inductive or heavy DC loads directly – 100 000 operations at 10A, 24V dc

Offer Marketing Illustration

Product benefits / Features

---

## Technical Benefits

### Harmony XB5

Conformity with IEC, UL, CSA, CCC EAC, and JIS standards, as well as CE marking and marine approvals

Up to IP66, 67, 69, 69K, and type 4X protection ratings

High vibration resistance with shake-proof terminal screws



Operating temperature from -40°C to 70°C

Shock protection level up to IK06

Secure switching of inductive or heavy DC loads directly – 100 000 operations at 10A, 24V dc

Offer Marketing Illustration

Product benefits / Features

---

### Features Harmony XB5



- 

Quick and easy assembly and disassembly
- 

Excellent mechanical connection with operator head
- 

Various types of connection: screw clamp, connector, Faston connector, spring terminal, or printed circuit board
- 

Large set of accessories to customize your panels
- 

Robustness to withstand harsh environments

Image of product / Alternate images

Alternative

---





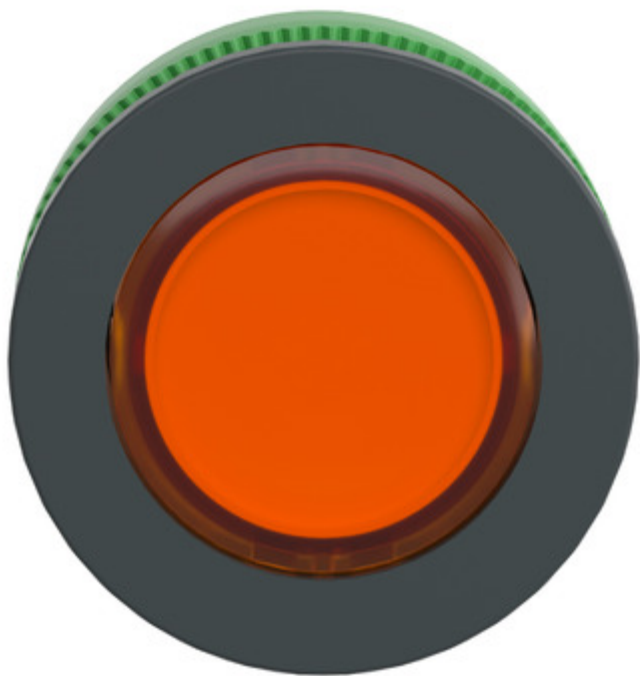

Image of product in real life situation

