

# Productinformatieblad

Specificaties



## Harmony - Tijdrelais - 10 functies - 1s-100 h 12-240V AC/DC - 10C

RE17RMMWS

EAN Code: 3606480552779

**Prijs: 72,95 EUR**

### Hoofd

range of product	Harmony-timerrelais
digitaal uitgangstype	Relais
product of component type	Modulaire tijdrelais
breedte	17,5 mm
device short name	RE17R
type tijdsvertraging	Vertraging bij inschakeling Vertraging bij in- en uitschakelen Print gegevens Vertraging bij uitschakeling Symmetrisch knipperend
tijdvertraging bereik	6...60 min 6...60 s 1...10 min 1...10 h 0,1...1 s 10...100 h 1...10 s
nominale uitgangsstroom	8 A

### Complementair

type en samenstelling contacten	1 C/O
contact materiaal	Cadmiumvrij
hoogte	90 mm
diepte	72 mm
besturingstype	Keuzeschakelaar voorpaneel
Us nominale voedingsspanning	12...240 V AC/DC 50/60 Hz
spanningsbereik	0,85...1,1 Us
voedingsfrequentie	50...60 Hz +/- 5 %
losser van input spanning	5 V
aansluitingen - aansluitklemmen	Veerklemmen, 2 x 0,2...2 x 1,5 mm <sup>2</sup> (AWG 24...AWG 16) vast zonder kabeluiteinde Veerklemmen, 2 x 0,2...2 x 1,5 mm <sup>2</sup> (AWG 24...AWG 16) flexibel met kabeluiteinde
materiaal behuizing	Polycarbonaat
herhalingsnauwkeurigheid	+/-0.5% In overeenstemming met IEC 61812-1
temperatuurafwijking	+/- 0,05 %/°C
spanningsverloop	+/- 0,2 %/V
instelling nauwkeurigheid tijdsvertraging	+/- 10% van totaal om 25 °C In overeenstemming met IEC 61812-1

De weergegeven prijs is de adviesprijs in euro excl. BTW. Deze kan onderhevig zijn aan korting. Neem contact op met uw lokale distributeur of detailhandel voor de daadwerkelijke prijs

<b>Time delay type</b>	Vertraging bij inschakeling - A- Vertragingrelais bij inschakeling Vertraging bij in- en uitschakelen - Ac - Vertraginginschakeling en uitschakelrelais m/ controlesignaal Vertraging bij inschakeling - Bij- Vertragingrelais bij inschakeling vermogen m/ pauze/optelling (Y1) Print gegevens - B- Eén intervalrelais met controlesignaal Print gegevens - Bw- Dubbel intervalrelais m/ besturingssignaal Vertraging bij uitschakeling - C- Uit-vertragingrelais m/ controlesignaal Symmetrisch knipperend - D- Symmetrisch knipperend relais (start pulse-off) Symmetrisch knipperend - Di- Symmetrisch knipperend relais (start puls-on) Print gegevens - H- Intervalrelais Print gegevens - Ht- Intervalrelais m/ pauze/optelling (Y1)
<b>impulsduur</b>	100 ms met belasting in parallel typisch 30 ms typisch
<b>isolatieweerstand</b>	100 MOhm om 500 V DC In overeenstemming met IEC 60664-1
<b>resettijd</b>	120 ms bij ontkrachting typisch
<b>on-load factor</b>	100 %
<b>maximaal energieverbruik in VA</b>	0...3 VA om 240 V AC
<b>maximaal energieverbruik in W</b>	1,5 W om 240 V DC
<b>minimale schakelstroom</b>	10 mA om 5 V DC
<b>maximale schakelstroom</b>	8 A AC/DC
<b>maximale schakelspanning</b>	250 V AC
<b>uitschakelvermogen</b>	2000 VA
<b>werkingssnelheid in Hz</b>	10 Hz
<b>elektrische duurzaamheid</b>	100000 cycles voor resistief belasting (8 A om 250 V AC maximum)
<b>mechanical durability</b>	10000000 cycles
<b>doorslagvastheid</b>	2,5 kV 1 mA/1 minuut 50 Hz In overeenstemming met IEC 61812-1
<b>Uimp toegekende schokgolfspanning</b>	5 kV gedurende 1,2/50 µs
<b>responsvertraging</b>	100 ms
<b>markering</b>	CE
<b>kruiweg</b>	4 kV/3 In overeenstemming met IEC 60664-1
<b>betrouwbaarheidsgegevens veiligheid</b>	MTTFd = 296.8 jaar B10d = 270000
<b>montagepositie</b>	Eender welke positie in verhouding tot het normale verticale montagevlak
<b>montagesteun</b>	35mm DIN rail In overeenstemming met IEC 60715
<b>lokale signalering</b>	LED-indicator voor brandt continu: relais van stroom voorzien, geen timing in uitvoering LED-indicator 80% ON en 20% OFF voor knippert: timing in uitvoering LED-indicator 5% ON en 95% OFF voor pulsing: relais afgefallen, geen timing bezig (met uitz. van functie Di-D, Li-L)
<b>functie beschikbaar</b>	A- Vertragingrelais bij inschakeling-1 C/O Ac - Vertraginginschakeling en uitschakelrelais m/ controlesignaal-1 C/O Bij- Vertragingrelais bij inschakeling vermogen m/ pauze/optelling (Y1)-1 C/O B- Eén intervalrelais met controlesignaal-1 C/O Bw- Dubbel intervalrelais m/ besturingssignaal-1 C/O C- Uit-vertragingrelais m/ controlesignaal-1 C/O D- Symmetrisch knipperend relais (start pulse-off)-1 C/O Di- Symmetrisch knipperend relais (start puls-on)-1 C/O H- Intervalrelais-1 C/O Ht- Intervalrelais m/ pauze/optelling (Y1)-1 C/O
<b>gewicht product</b>	0,07 kg
<b>control type</b>	Zonder testknop
<b>Aantal functies</b>	10

Type tijdvertraging	A, Ac, At, B, Bw, C, D, Di, H, Ht
functionaliteit	Multifunctioneel
compatibility code	RE17

## Omgeving

immuñiteit voor micro-onderbrekingen	20 ms
standards	2006/95/EC IEC 61000-6-4 2004/108/EC IEC 61000-6-3 IEC 61812-1 IEC 61000-6-2 IEC 61000-6-1
product certifications	GL cULus CSA
ambient air temperature for storage	-30...60 °C
omgevingstemperatuur voor werking	-20...60 °C
IP beschermingsgraad	IP20 In overeenstemming met IEC 60529 (aansluitblok) IP40 In overeenstemming met IEC 60529 (behuizing) IP50 In overeenstemming met IEC 60529 (voorpaneel)
trilling bestendigheid	20 m/s <sup>2</sup> (f= 10...150 Hz) In overeenstemming met IEC 60068-2-6
schokbestendigheid	15 gn voor 11 ms In overeenstemming met IEC 60068-2-27
relatieve vochtigheid	93 % zonder condensatie In overeenstemming met IEC 60068-2-30
elektromagnetische compatibiliteit	Elektrostatische ontlading immuñiteitstest: , 6 kV (in contact), niveau 3, conform aan IEC 61000-4-2 Elektrostatische ontlading immuñiteitstest: , 8 kV (in lucht), niveau 3, conform aan IEC 61000-4-2 Gevoelig aan elektromagnetische velden: , 10 V/m (80 MHz tot 1 GHz), niveau 3, conform aan IEC 61000-4-3 Elektrische snelle transiënte/burst immuñiteitstest: , 1 kV (capacitieve verbindingsclip), niveau 3, conform aan IEC 61000-4-4 Elektrische snelle transiënte/burst immuñiteitstest: , 2 kV (rechtstreeks), niveau 3, conform aan IEC 61000-4-4 1,2/50 µs schokgolven immuñiteitstest: , 1 kV (differentieelmodus), niveau 3, conform aan IEC 61000-4-5 1,2/50 µs schokgolven immuñiteitstest: , 2 kV (gewone modus), niveau 3, conform aan IEC 61000-4-5 Geleidende RF verstoringen: , 10 V (0,15...80 MHz), niveau 3, conform aan IEC 61000-4-6 Spanningsval en onderbrekingen immuñiteitstest: , 0 % (1 cyclus), conform aan IEC 61000-4-11 Spanningsval en onderbrekingen immuñiteitstest: , 70 % (25/30 cycli), conform aan IEC 61000-4-11 Geleide en uitgestraalde emissies: , klasse B, conform aan EN 55022

## Verpakkingseenheid

Eenheidstype van verpakking 1	PCE
Aantal eenheden in verpakking 1	1
verpakking 1 hoogte	2,7 cm
verpakking 1 breedte	7,8 cm
verpakking 1 lengte	9,5 cm
verpakking_1_gewicht	75 g
Eenheidstype van verpakking 2	S02
Aantal eenheden in verpakking 2	40

---

verpakking 2 hoogte	15 cm
verpakking 2 breedte	30 cm
verpakking 2 lengte	40 cm
verpakking 2 gewicht	3,484 kg

---

## contractuele waarborg

---

Garantie (in maanden)	18
-----------------------	----

Schneider Electric wil tegen 2050 de Net Zero-status hebben bereikt via partnerschappen in de toeleveringsketen, materialen met een lagere impact en circulariteit via onze doorlopende campagne "Use Better, Use Longer, Use Again" om de levensduur van producten en de recycleerbaarheid te verlengen.

[Uitleg van Environmental Data >](#)

[Hoe evalueren we de duurzaamheid van producten? >](#)

### Milieuoetafdruk

Totale levenscyclus ecologische voetafdruk	43 kg CO2 eq.
Koolstofvoetafdruk van de fabricagefase [A1–A3]	2 kg CO2 eq.
Koolstofvoetafdruk van de distributiefase [A4]	0.1 kg CO2 eq.
Koolstofvoetafdruk van de installatiefase [A5]	0 kg CO2 eq.
Koolstofvoetafdruk van de gebruiksfase [B2, B3, B4, B6]	41 kg CO2 eq.
Koolstofvoetafdruk van de einde-levensfase [C1–C4]	0.2 kg CO2 eq.
Milieu Profiel	<a href="#">Milieuprofiel van het product</a>

### Use Better

#### Materialen en verpakking

Pakket met gerecycleerd karton	Ja
Verpakkingen zonder kunststof	Ja
SCIP-nummer	7bdc2711-0ad2-427c-8ece-532c5e9f09d7
RoHS-richtlijn van de EU	<a href="#">Conform door vrijstelling</a>
REACH-verordening	<a href="#">Referentie bevat zorgwekkende stoffen (SVHC) boven drempelwaarde</a>

### Use Longer

#### Levensduurverlenging

Reparatie	Nee
-----------	-----

### Use Again

#### Herverpakken en herfabriceren

Percentage mogelijke recycleerbaarheid	13
Circulair Profiel	<a href="#">Informatie over einde levensduur</a>
Terugname	Ja

Dimensions Drawings

Width 17.5 mm

---

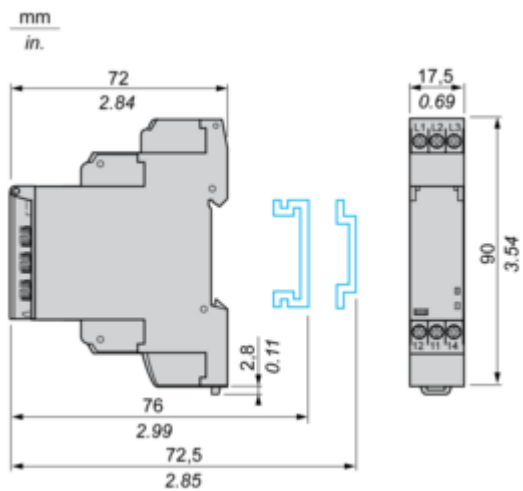

Connections and Schema

Internal Wiring Diagram

---

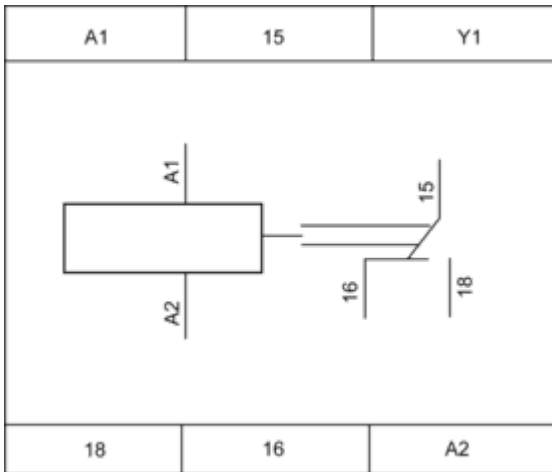

## Wiring Diagram

---

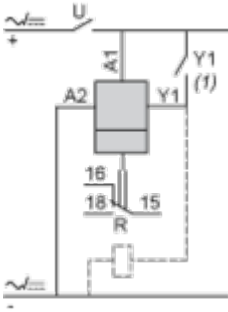

### 1) Contact Y1:

- Control for functions B, C, Ac, Bw, Ad, Ah, N, O, W, T, Tt.
- Partial stop for functions At, Ht and Pt.
- Function D if Di selected.
- Not used for functions A, H and P.

Technical Description

Function A : Power on Delay Relay

---

**Description**

The timing period T begins on energisation. After timing, the output(s) R close(s). The second output can be either timed or instantaneous.

**Function: 1 Output**



**Function: 2 Outputs**

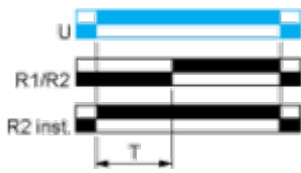

2 timed outputs (R1/R2) or 1 timed output (R1) and 1 instantaneous output (R2 inst.)

**Function Ac: On-Delay & Off-Delay with Control Signal**

---

**Description**

After energisation of power supply and energization of Y1 causes the timing period T to start.

At the end of this timing period, the output(s) R close(s).

When deenergization of Y1, the timing T starts.

At the end of this timing period T, the output(s) R revert(s) to its/their initial position.

The second output (R2) can be either timed (when set to "TIMED") or instantaneous (when set to "INST").

**Function: 1 Output**

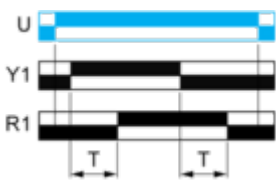

**Function: 2 Outputs**

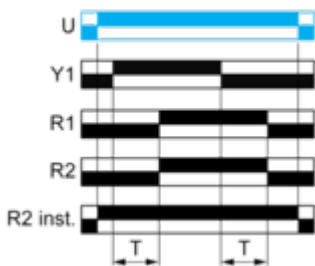

**Function At : Power on Delay Relay (Summation) with Control Signal**

---

**Description**

After power-up, the first opening of control contact C starts the timing. Timing can be interrupted each time control contact C closes. When the cumulative total of time periods elapsed reaches the pre-set value T, the output relay closes.

**Function: 1 Output**

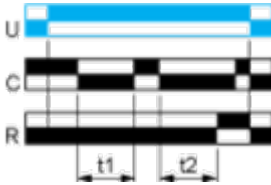

$T = t1 + t2 + \dots$

**Function B : Interval Relay with Control Signal**

---

**Description**

After power-up, pulsing or maintaining control contact C starts the timing T. The output R closes for the duration of the timing period T then reverts to its initial state.

**Function: 1 Output**

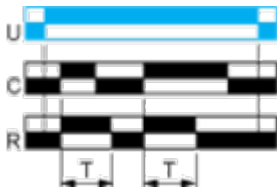

**Function Bw : Double Interval Relay with Control Signal**

---

**Description**

On closing and opening of control contact C, the output R closes for the duration of the timing period T.

**Function: 1 Output**

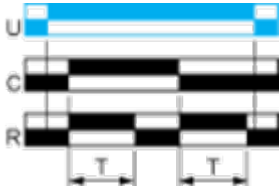

**Function C : Off-Delay Relay with Control Signal**

---

**Description**

After power-up and closing of the control contact C, the output R closes. When control contact C re-opens, timing T starts. At the end of the timing period, the output(s) R revert(s) to its/their initial state. The second output can be either timed or instantaneous.

**Function: 1 Output**

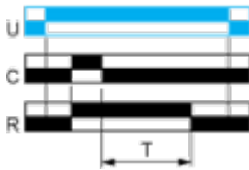

**Function: 2 Outputs**

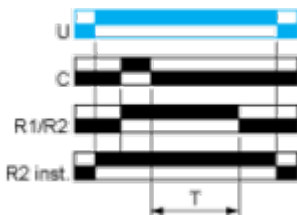

2 timed outputs (R1/R2) or 1 timed output (R1) and 1 instantaneous output (R2 inst.)

**Function D: Symmetrical Flashing Relay (Starting Pulse Off)**

---

**Description**

On energisation of power supply, output(s) R starts at its/their initial state for timing duration T then change(s) to output(s) R close(s) for the same timing duration T. This cycle is repeated indefinitely until power supply removal. Specially for RE17\*, RE22R2AMU, RE22R2MMW, RE22R2MMU, RE22R2MJU, this D function can only be initiated by energizing Y1 permanently. The second output (R2) can be either timed (when set to "TIMED") or instantaneous (when set to "INST").

**Function: 1 Output**

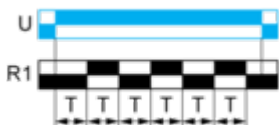

**Function: 2 Outputs**

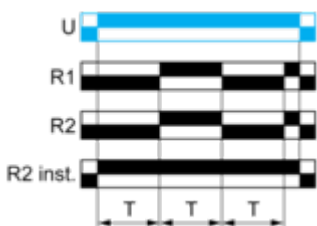

**Function: 1 Output with Retrigger / Restart Control**



**Function: 2 Output with Retrigger / Restart Control**

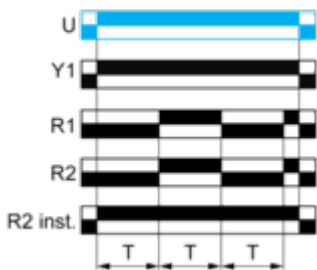

**Function Di : Symmetrical Flasher Relay (Starting Pulse On)**

---

**Description**

Repetitive cycle with two timing periods T of equal duration, with output(s) R changing state at the end of each timing period T.

The second output can be either timed or instantaneous.

**Function: 1 Output**



**Function: 2 Outputs**

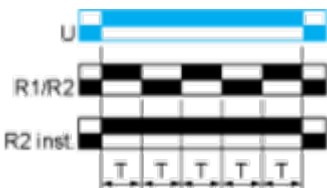

2 timed outputs (R1/R2) or 1 timed output (R1) and 1 instantaneous output (R2 inst.)

**Function H : Interval Relay**

---

**Description**

On energisation of the relay, timing period T starts and the output(s) R close(s). At the end of the timing period T, the output(s) R revert(s) to its/their initial state. The second output can be either timed or instantaneous.

**Function: 1 Output**



**Function: 2 Outputs**

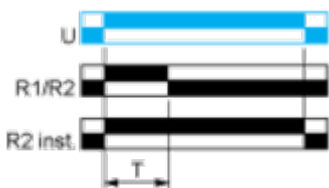

2 timed outputs (R1/R2) or 1 timed output (R1) and 1 instantaneous output (R2 inst.)

**Function Ht: Interval Relay & With Pause / Summation Control**

**Description**

On energisation of power supply, output(s) R close(s) and timing period T starts.

The timing can be interrupted / paused each time X1 energizes.

When the cumulative total of time periods elapsed reaches the pre-set value T, the output(s) R revert(s) to its/their initial state Reenergization of X1 will also cause output(s) R close(s) if the time has elapsed and restart the same operation as described at the beginning.

Except for RE17\*, RE22R2MMW, RENF22R2MMW, RE22R2MMU and RE22R2MJU, timing can be interrupted / paused each time Y1 energizes.

The second output (R2) can be either timed (when set to "TIMED" or instantaneous (when set to "INST").

**Function: 1 Output**

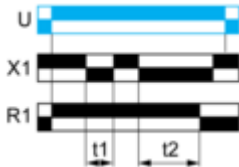

$T = t1 + t2 + \dots$

**Function: 2 Outputs**

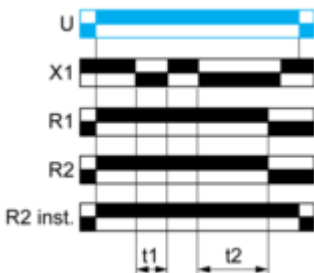

$T = t1 + t2 + \dots$

**Function: 1 Output with Retrigger / Restart Control**

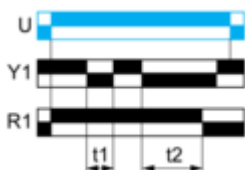

$T = t1 + t2 + \dots$



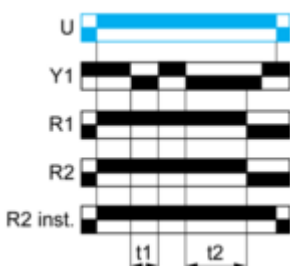

**Function: 2 Outputs with Retrigger / Restart Control**



$T = t1 + t2 + \dots$

**Legend**

---

	Relay de-energised
	Relay energised
	Output open
	Output closed

C	Control contact
G	Gate
R	Relay or solid state output
R1/R2	2 timed outputs
R2 inst.	The second output is instantaneous if the right position is selected
T	Timing period
Ta -	Adjustable On-delay
Tr -	Adjustable Off-delay
U	Supply

Technical Illustration

Dimensions

---

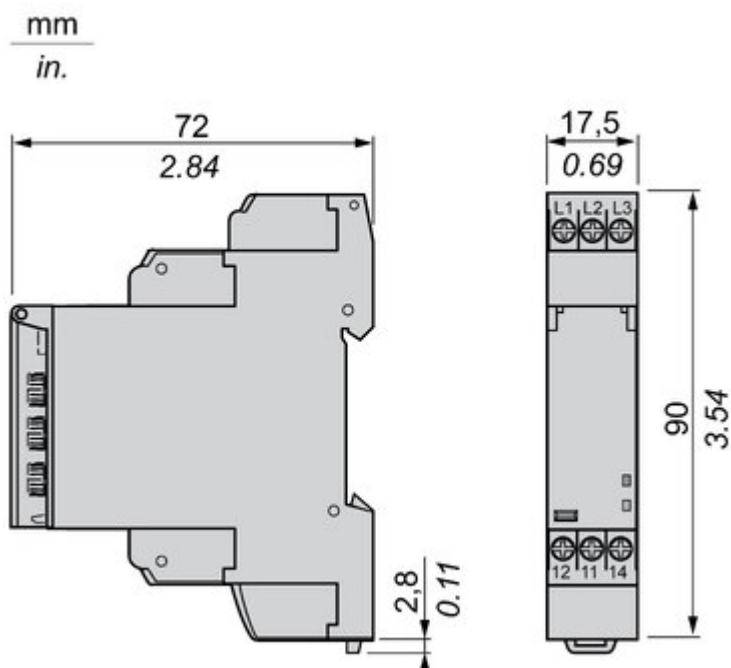

Offer Marketing Illustration

Product benefits / Features

---

## Technical Benefits

### Harmony Timer Relay

Flexible choice of screw or spring connection terminals for wiring.

One product reference covering 28 timing functions, 2 outputs, and a wide range of supply voltage 24...240 V AC/DC.

Dust and unintended human intervention avoided thanks to the IP50 lead-sealable settings protection cover.



A Dial-Pointer LED indicator that enhances ease of operation in difficult environments such as dusty or low-light conditions

Different mounting style to meet your preference:  
DIN rail mount with product width; 17.5 mm/0.69 in.  
22.5 mm/0.88 in.  
Plug in mounting with socket

Offer Marketing Illustration

Product benefits / Features

---



### Features

#### Harmony Timer Relay

-  "Diagnostic button" to check downstream circuit immediately, shorten the commission and troubleshooting time
-  Compatible with a wide range of applications including machines, buildings, water segments, and HVAC.
-  Wide range of time delay for adjustment: from 0.01 s to 999 hrs.
-  Compliant with IEC 60255-1 standard, and a wide array of product certifications such as UL, CE, CSA, EAC.
-  Unprecedented accuracy, predictive maintenance, and superior security.

Image of product / Alternate images

Alternative

---

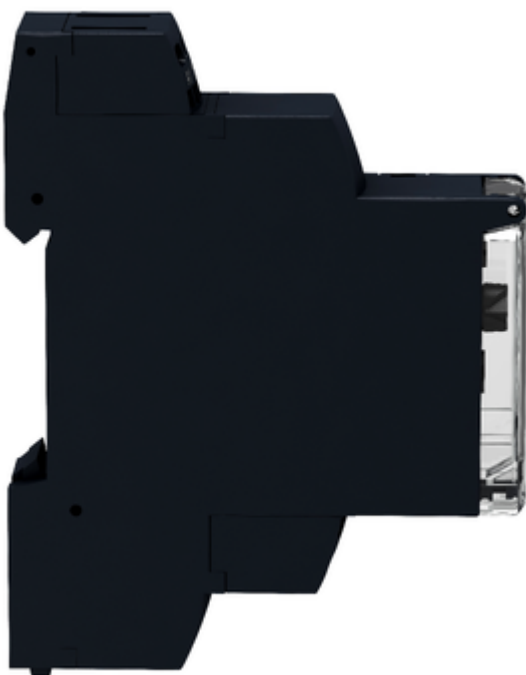





Image of product in real life situation

