

Color: ■ white

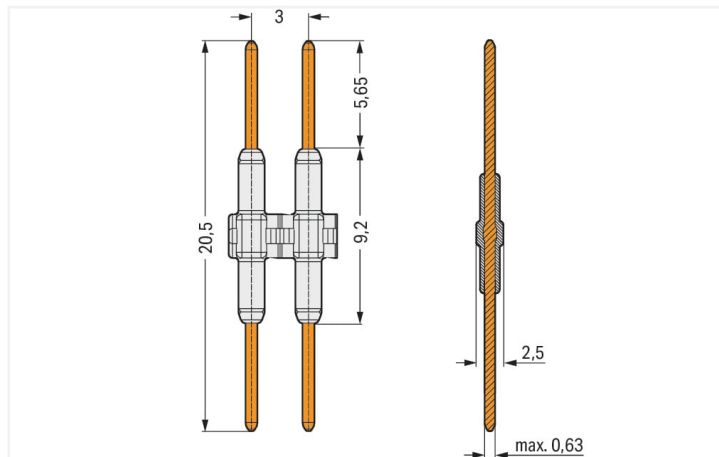

Dimensions in mm

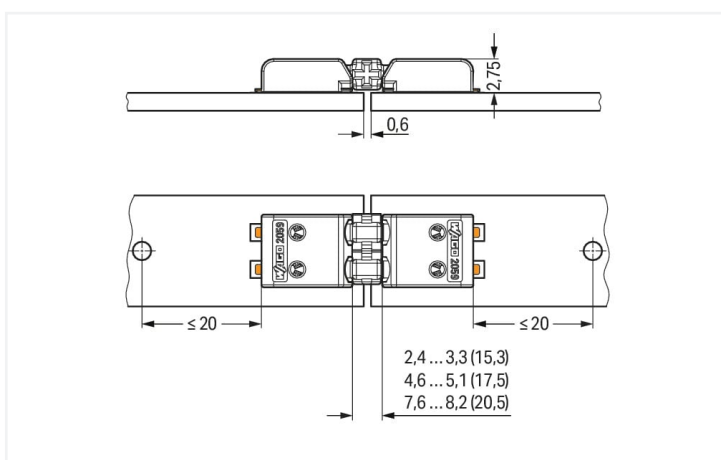

Dimensions in mm

- Board-to-board links simplify LED module assembly
- Easy push-in connection and disconnection

Electrical data

Ratings per	IEC/EN 60664-1		
	III	III	II
Overvoltage category	III	III	II
Pollution degree	3	2	2
Nominal voltage	63 V	160 V	320 V
Rated surge voltage	2.5 kV	2.5 kV	2.5 kV
Rated current	3 A	3 A	3 A

Connection data

Total number of potentials	3
----------------------------	---

Connection 1

Pole number	3
-------------	---

Physical data

Pin spacing	3 mm / 0.118 inches
Width	8.7 mm / 0.343 inches
Height	2.5 mm / 0.098 inches
Depth	20.5 mm / 0.807 inches

Mechanical data

Mating cycles (max.)	10
Number of mating cycles	10 connections/disconnections (max.)
Suitable	for SMD PCB terminal blocks (2059 Series)

Material data

Note (material data)	Information on material specifications can be found here
Color	white
Material group	I
Insulation material	Polyamide (PA66)
Flammability class per UL94	V0
Contact material	Copper alloy
Contact plating	Silver
Fire load	0.002 MJ
Weight	0.2 g

Environmental requirements

Limit temperature range	-60 ... +105 °C
-------------------------	-----------------

Commercial data

eCl@ss 10.0	27-14-11-92
eCl@ss 9.0	27-14-11-92
ETIM 8.0	EC002848
ETIM 7.0	EC002848
PU (SPU)	375 pcs
Packaging type	Box
Country of origin	CN
GTIN	4055143610001
Customs tariff number	85369010000

Environmental Product Compliance

RoHS Compliance Status	Compliant, No Exemption
------------------------	-------------------------

Approvals / Certificates

General approvals



Approval	Standard	Certificate Name
CCA DEKRA Certification B.V.	EN 60947-7-4	NTR NL-7819
CCA DEKRA Certification B.V.	EN 60947-7-4	71-111131
CCA DEKRA Certification B.V.	EN 60838	NTR NL-7720
cURus Underwriters Laboratories Inc.	UL 1059	E45172
KEMA/KEUR DEKRA Certification B.V.	EN 60838	71-106226
UL Underwriters Laboratories Inc.	UL 1977	E45171

Downloads

Environmental Product Compliance

Compliance Search	
Environmental Product Compliance 2059-903/021-000	↓

Documentation

Additional Information			
Technical Section	03.04.2019	pdf 2010.85 KB	↓

CAD/CAE-Data

CAD data	
2D/3D Models 2059-903/021-000	↓

CAE data	
ZUKEN Portal 2059-903/021-000	↓

Installation Notes

Installation



Installation

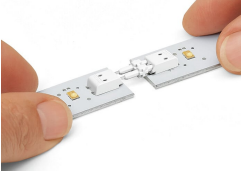

Installation

