



# OptiLine 45

Catalogue 2022



[se.com](http://se.com)

Life Is On

**Schneider**  
Electric



# Contents

## OptiLine 45 Trunking

Presentation .....	6
Dimensions.....	9
Cable capacity .....	10
Choice guide .....	12
Range.....	15

## OptiLine 45 Poles

Presentation .....	24
Range.....	29
Technical description .....	34

## OptiLine 45 Posts

Presentation .....	35
Range.....	39
Technical description .....	41

## OptiLine 45 Service boxes

Presentation .....	44
Range.....	45
Technical description .....	50

## OptiLine 45

Reference number overview .....	52
---------------------------------	----



# OptiLine 45

## The 45 direct Click-in installation system



Electrical, telephone and data installations must be easy to install, safe to use and flexible enough to ensure that changes are easy to make. The design of the visible parts must also set the right tone in the office.

OptiLine 45 direct click-in installation system provide integrated installation solutions for ceilings, walls, floors and desks.

Together with Unica wiring devices, solutions are created that fulfil the most stringent demands for function, design, convenience and safety.



### Direct click-in installation system

- 45 mm front opening
- Direct click-in of Unica 45x45 module wiring devices which gives optimal function and design.

### Environment-friendly

- Only lead-free and cadmium-free PVC is used
- The aluminium range offers a halogen-free alternative, including accessories.

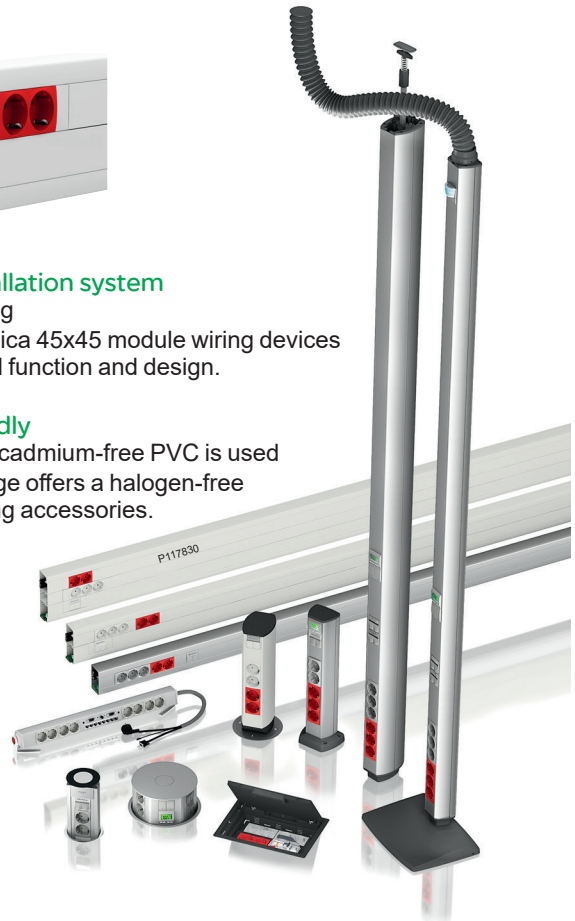

### New Unica 45x45 module wiring devices

New Unica is a wiring device series suitable for direct click-in in OptiLine 45 trunking, poles, posts, floor boxes and service boxes.

#### Range

Unica offers a broad range of socket outlets, switches, VDI outlets and electronic products such as dimmers, movement detectors, thermostats and timers.

#### Main benefits

- Optional mounting direction for correct user interface in both trunking, poles and posts
- Connection piece for simple interconnection of double and triple outlets without space between
- 45° terminals. Easy to connect even though the outlets are close together
- Dual input and output terminals. For easy loop-through of additional connections such as earthing of trunking.

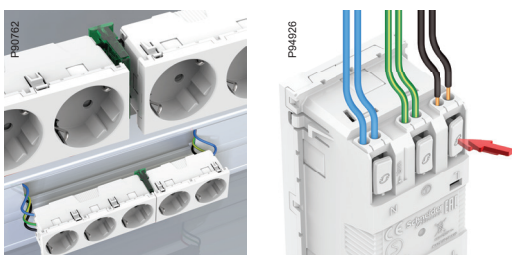





## Trunking

A cost-effective installation with high capacity.

### The range

Available in PVC or aluminium with one, two or three compartments.



### Main benefits:

- Easy installation without the need of instructions. Accessories are mounted directly without adaptation
- 55 mm depth. High cable capacity and space behind the wiring devices
- Pre-punched slots in the partition walls of the PVC trunking. Easy to make holes or openings to feed cables between the compartments
- Trunking base and cover packed together, but not assembled. Easy handling
- Extra-secure click-in function and front locking clip. Gives improved pull-out force.

## Poles

The best solution for a truly flexible office, with power, telecom and data services close to the workplaces. Fed from the ceiling, preferably from connection boxes. Free-standing and movable poles give extra freedom. A pole can be moved within a radius of up to 1.5 metres from the connection point in the ceiling.

### The range

Available in aluminium, free-standing or tension-mounted. One or two-sided, or with four boxes.



### Main benefits:

- Design: Aluminium with a high surface finish. Softly rounded and slender form
- Stable, sturdy design. Several parts are cast
- Movable poles have steady feet. The rectangular foot also allows poles to be installed back-to-back or against a wall
- The adjustable ceiling fixing for tension-mounted poles can be fitted easily without tools. Spring-loaded. Total working range of 400 mm
- Cable separation profile gives the correct spacing between VDI and power cables.

## Posts

For power, telecom and data installations close to workplaces, on raised access floors, on screeded floor boxes in concrete floors or on in-cavity floors. Can also be used with other floors, in which case they are supplied via a floor feeder or a floor grommet.

### The range

Available in aluminium in one and two-sided versions.

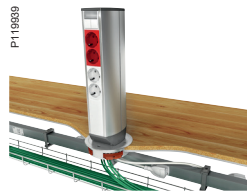

### Main benefits:

- Design: Aluminium with a high surface finish. Softly rounded and compact form
- Stable, sturdy design. Several parts are cast
- Accessories for above-floor supply
- Cable separation profile gives the correct spacing between VDI and power cables.

## Service boxes

Flexible solutions for the supply of power, telecom and data to desks in offices and conference rooms. The boxes can also be used as connection points in the ceiling for feeding of poles.



### The range

- Five box types, all in natural anodised aluminium:
- A six-sided pop-up box, pre-wired with outlets, cable and plug
  - A mini pop-up, empty
  - A turnable and smoothly rounded one-sided box. Pre-wired with outlets, cables and plugs.
  - A one-sided box, empty.
  - A flip-up box for flush mounting in desks, empty.

### Main benefits:

- The range covers many applications
- Many mounting options including concealed installation
- All products in aluminium and metal – high finish and impact resistant
- Ceiling cable feeder – flexible solution also for movable desks.

# OptiLine 45 Trunking Presentation



## Installation trunking with 45 mm front opening for direct click-in of Unica wiring devices

OptiLine 45 trunking are available in lead- and cadmium-free PVC or aluminium with a 45 mm front opening. All trunking are 55 mm deep, which gives a high cable capacity and space for cables behind the wiring devices. One of the main advantages is the easy installation. The design is symmetrical and all accessories are click-in mounted without any need of adaptations. It is also very easy to create cross sectional feeding of the cables in the PVC trunking thanks to the pre-punched slots in the partition walls.

Dedicated installation fixings and an extra-secure click-in function for the front and Unica wiring devices give a very reliable installation.

Also the handling is easy. The trunking base and cover are packed together, but not assembled.

### PVC Trunking



**75x55**  
With one compartment

**95x55**  
With one compartment

**140x55**  
With two compartments

**165x55**  
With two compartments, especially intended for VDI installations

**185x55**  
With three compartments

### Aluminium Trunking



**75x55**  
With one compartment

**95x55**  
With one compartment

**140x55**  
With one compartment

**165x55**  
With two compartments

**185x55**  
With two compartments



### Unica 45x45 module wiring devices

The OptiLine 45 range has a front opening for direct click-in of Unica 45x45 module wiring devices which gives optimal function and design.

Unica offers a broad range of socket outlets, switches, VDI outlets and electronic products such as dimmers, movement detectors, thermostats, timers.

### The complete trunking system

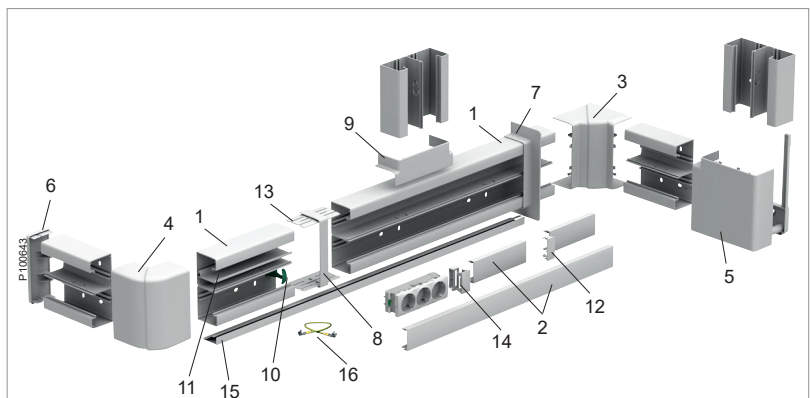

- |                               |                                       |
|-------------------------------|---------------------------------------|
| 1. Trunking base              | 12. Joint cover piece for front cover |
| 2. Front cover                | 13. Jointing piece                    |
| 3. Internal corner            | 14. Front locking clip                |
| 4. External corner            | 15. Sealing strip                     |
| 5. Bend 90°, incl wall fixing | 16. Earthing kit (Aluminium trunking) |
| 6. Stop end                   |                                       |
| 7. Wall/ceiling frame         |                                       |
| 8. Joint cover piece          |                                       |
| 9. T-piece                    |                                       |
| 10. Cable retainer            |                                       |
| 11. Cable shelf               |                                       |



# OptiLine 45 Trunking Presentation

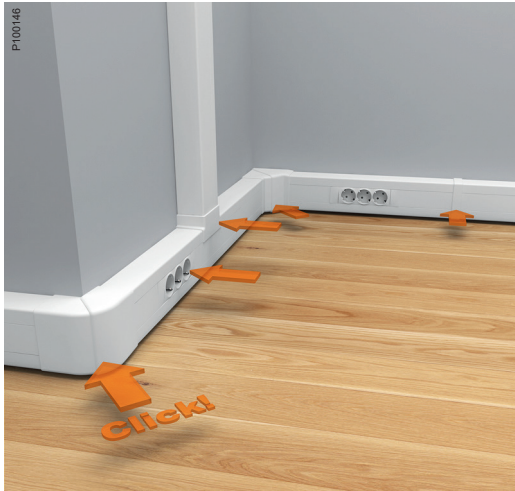

### Click-in accessories

All accessories are designed for easy click-in mounting without tools.

- Easy installation without instructions
- Mounted directly without adaptations
- Mounted when trunking is in place.



### Efficient mounting support

Both PVC and aluminium trunking profiles are prepared for fast, exact and reliable installation.

- Pre-punched oval holes every 25 cm
- Easy to make X and Y adjustments.

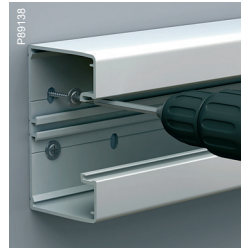

### Professional tools and fixings

Dedicated tools and fixings for fast and safe installation.

- Extra long drills and bits to avoid damaging the front when using a drilling machine
- Fixings suitable for any material
- Screws for PVC trunking
- Screws to be used together with single-insulated wires.



### Perfect joints

Two jointing pieces for exact levelling and a click-in joint cover piece to hide the gap

- Perfect joints
- No tools needed
- Joint cover piece in one piece
- The jointing pieces can also be used for joints without joint cover piece.

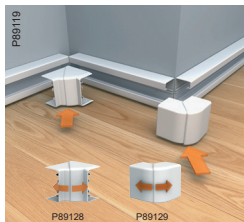

### Adjustable corners

The adjustable corners are delivered in one piece.

- Easy and quick to mount
- No adaptations needed.

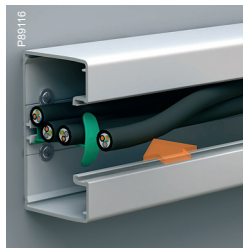

### The cable retainer – a helping hand

The cable retainer keeps all the cables in place in the trunking during the installation.

- Faster installation
- One man can do the work
- Green colour for quick identification
- Can remain in place also after the installation.

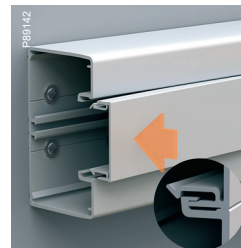

### Secure front cover

Auto-guided and extra secure click-in for the front. High-quality material.

- Easy to mount also when kneeling
- Works reliably even at low temperatures
- Can not be opened without a tool
- IP40 classified.

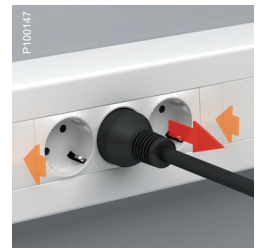

### Pull-out safe outlets

Extra secure click-in function combined with a front locking clip.

- High pull-out loads on the wiring devices
- Design aligned with Unica.



### Pre-punched slots for easy hole making

Pre-punched slots in the PVC partition walls.

- Easy hole making by hand or with a screwdriver
- Allows cross-sectional feeding of cables.

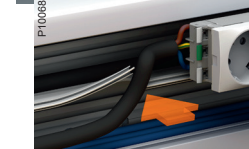
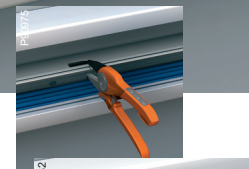

### Easy feeding without threading

The pre-punched slots can be cut up with a cutting shears.

- The cables can be laid in without threading
- Very easy to feed cables between the compartments
- Cables and outlets can be separated.



### Protective foil

Protective foil on both sides of the trunking base and on the front cover. The main product references including pictures are printed on the foil.

- No surface damages during the installation
- Easy to order new parts.



### Dust protection

A sealing strip can be fitted between the trunking and the floor.

- 5-15 mm coverage
- Easy cleaning
- Solid impression.



### Smart package

The trunking base and front covers are packed together, but not assembled.

- Easy handling
- No damages. The covers are protected until final installation.



# OptiLine 45 Trunking Presentation

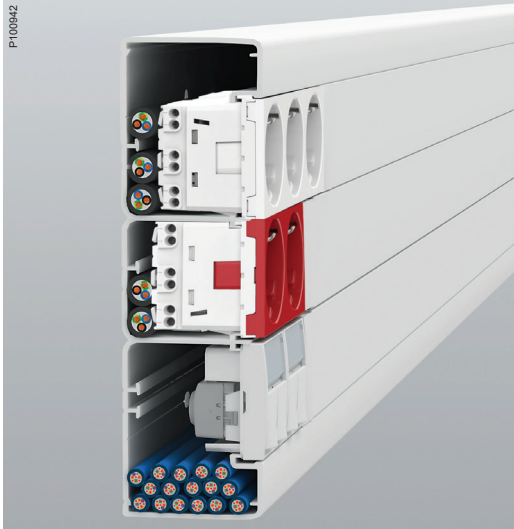

### Three-compartment trunking

The three-compartment trunking allows a dedicated space for the wiring devices.

- Maximum distance between VDI and power cables
- High capacity
- Easy installation.



### Symmetrical design

The trunking base is symmetrical and has a softly rounded form.

- Easy and safe mounting
- No risk of installing the trunking upside-down
- The trunking form guides the accessories in place.



### 55 mm depth

All trunking are 55 mm deep.

- High cable capacity
- Space enough for 3x2.5 mm<sup>2</sup> cables behind the wiring devices.

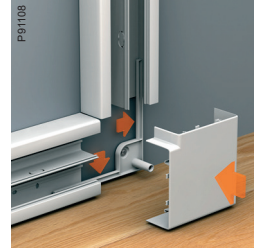

### Perfect bends

The bend kit includes an adjustable fixing device to be screw-fitted to the wall.

- Large tolerances when cutting and fixing the trunking
- Self-guiding mounting of the bend piece
- Perfect result and finish.



### High classification

The trunking is IP40 and IK07 classified.

- Safe and impact resistant
- Can not be opened without a tool.

The PVC trunking is fire classified in category M1.



### One-compartment trunking

Suitable for both installation and distribution. A cable shelf separates VDI cables from power cables.

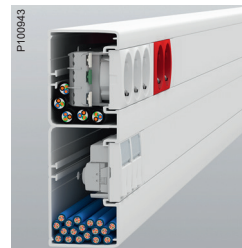

### Dedicated VDI trunking

A non-symmetrical two-compartment trunking especially intended for VDI installations.

- Extra space for VDI cables in the larger lower compartment
- Long distance between VDI and power cables.



### Easy earthing of aluminium trunking

The aluminium trunking base and front cover has easily accessible earthing rails. A pre-mounted earthing kit is available on one reference number.

- Easy to order
- Quick and easy to mount
- Screwless mounting.



# OptiLine 45 Trunking

## Dimensions

### PVC

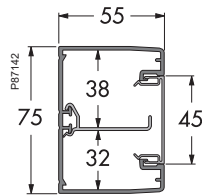

**75x55**

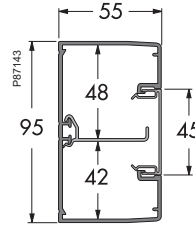

**95x55**

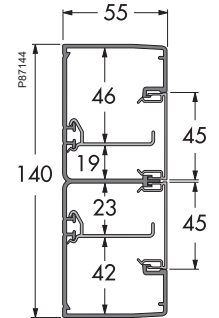

**140x55**

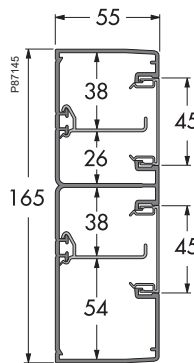

**165x55**

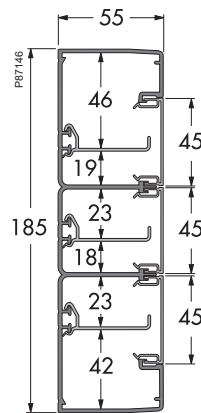

**185x55**

### Aluminium Trunking

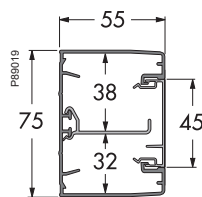

**75x55**

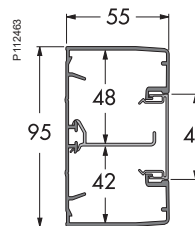

**95x55**

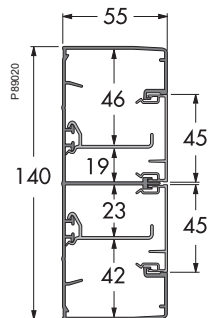

**140x55**

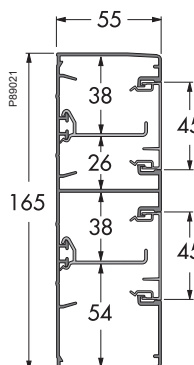

**165x55**

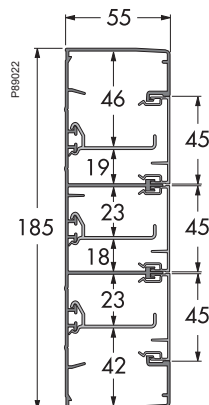

**185x55**

# OptiLine 45 Trunking

## Cable capacity

### Cable capacity

#### Installation trunking 75x55 and 95x55 mm

**75x55 and 95x55 without outlets**  
If the trunking is used as a feeder trunking please use this guide to calculate the cable capacity.



Com-part-ment	Fill factor	
	100%	50%
	Inner area	Inner area
■	3508 mm <sup>2</sup>	1754 mm <sup>2</sup>
■	4505 mm <sup>2</sup>	2253 mm <sup>2</sup>

**75x55 and 95x55 with Unica outlets**  
If the trunking is used as an installation trunking please use this guide to calculate the cable capacity.

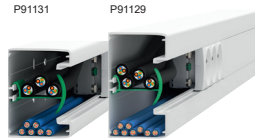

Com-part-ment	Fill factor	
	100%	50%
	Inner area	Inner area
■	2385 mm <sup>2</sup>	1193 mm <sup>2</sup>
■	3382 mm <sup>2</sup>	1691 mm <sup>2</sup>

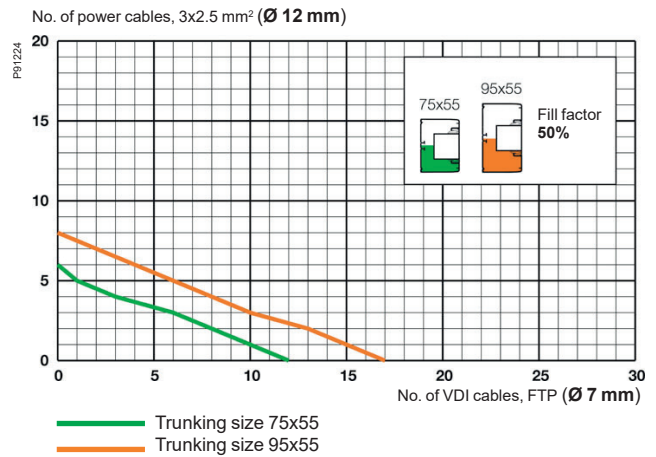
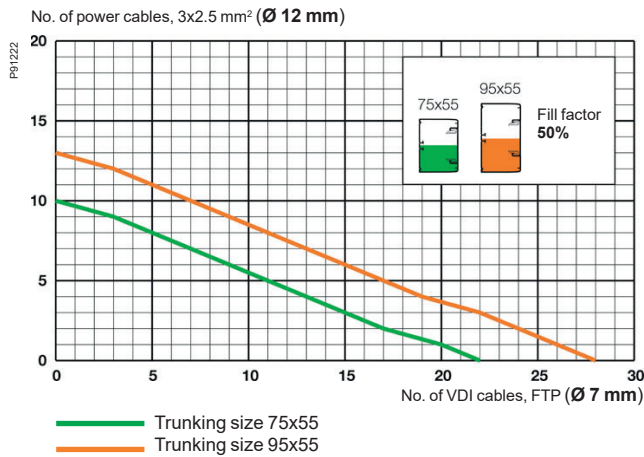

#### Installation trunking 140x55 mm

**140x55 without outlets**  
If the trunking is used as a feeder trunking please use this guide to calculate the cable capacity.

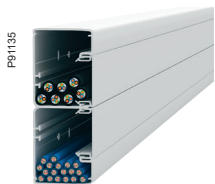

Com-part-ment	Fill factor	
	100%	50%
	Inner area	Inner area
■	3303 mm <sup>2</sup>	1652 mm <sup>2</sup>
■	3303 mm <sup>2</sup>	1652 mm <sup>2</sup>

**140x55 with Unica outlets**  
If the trunking is used as an installation trunking please use this guide to calculate the cable capacity.



Com-part-ment	Fill factor	
	100%	50%
	Inner area	Inner area
■	2180 mm <sup>2</sup>	1090 mm <sup>2</sup>
■	2180 mm <sup>2</sup>	1090 mm <sup>2</sup>

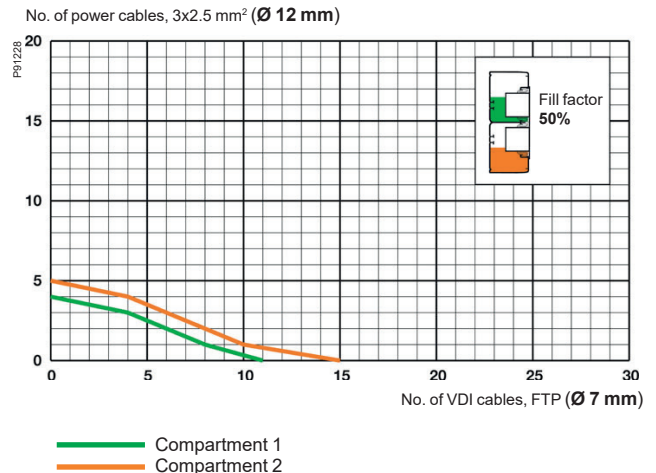
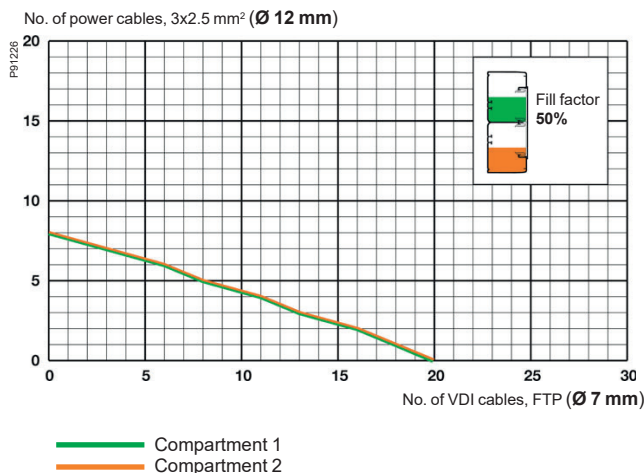

*A more detailed calculation can be made in the OptiLine system specification tool.*



# OptiLine 45 Trunking

## Cable capacity

### Cable capacity

#### Installation trunking 165x55 mm

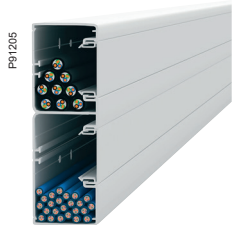

**165x55 (VDI) without outlets**  
If the trunking is used as a feeder trunking please use this guide to calculate the cable capacity.

Com-part-ment	Fill factor	
	100%	50%
	Inner area	Inner area
■	3374 mm <sup>2</sup>	1687 mm <sup>2</sup>
■	4358 mm <sup>2</sup>	2179 mm <sup>2</sup>

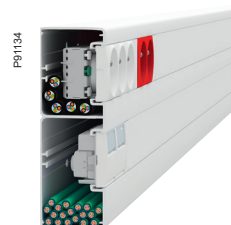

**165x55 (VDI) with Unica outlets**  
If the trunking is used as an installation trunking please use this guide to calculate the cable capacity.

Com-part-ment	Fill factor	
	100%	50%
	Inner area	Inner area
■	2251 mm <sup>2</sup>	1126 mm <sup>2</sup>
■	3235 mm <sup>2</sup>	1618 mm <sup>2</sup>

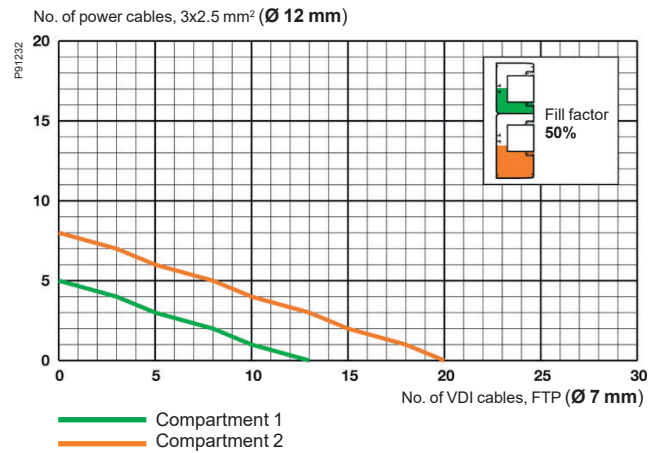
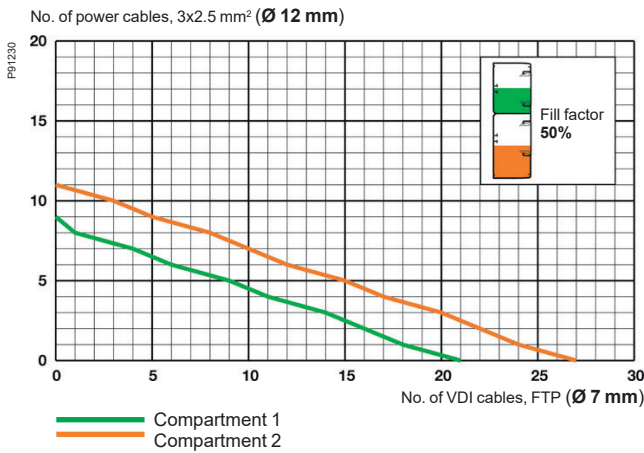

#### Installation trunking 185x55 mm

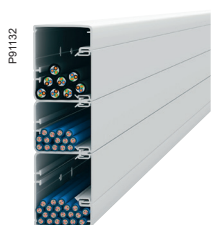

**185x55 without outlets**  
If the trunking is used as a feeder trunking please use this guide to calculate the cable capacity.

Com-part-ment	Fill factor	
	100%	50%
	Inner area	Inner area
■	3218 mm <sup>2</sup>	1609 mm <sup>2</sup>
■	2187 mm <sup>2</sup>	1094 mm <sup>2</sup>
■	3218 mm <sup>2</sup>	1609 mm <sup>2</sup>

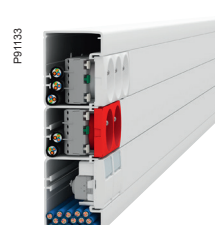

**185x55 with Unica outlets**  
If the trunking is used as an installation trunking please use this guide to calculate the cable capacity.

Com-part-ment	Fill factor	
	100%	50%
	Inner area	Inner area
■	2095 mm <sup>2</sup>	1048 mm <sup>2</sup>
■	1064 mm <sup>2</sup>	532 mm <sup>2</sup>
■	2095 mm <sup>2</sup>	1048 mm <sup>2</sup>

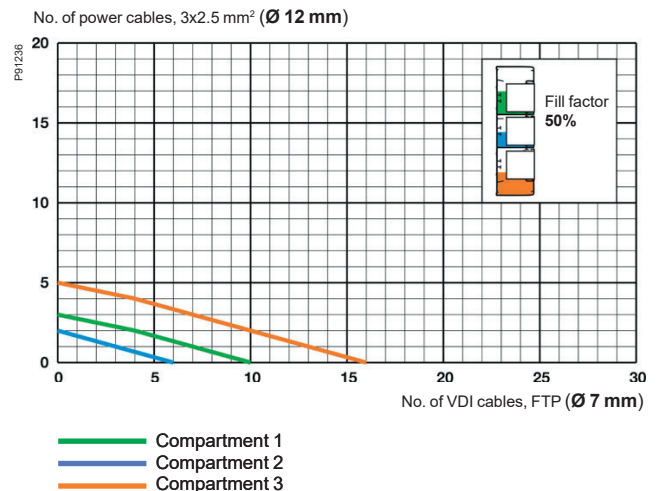
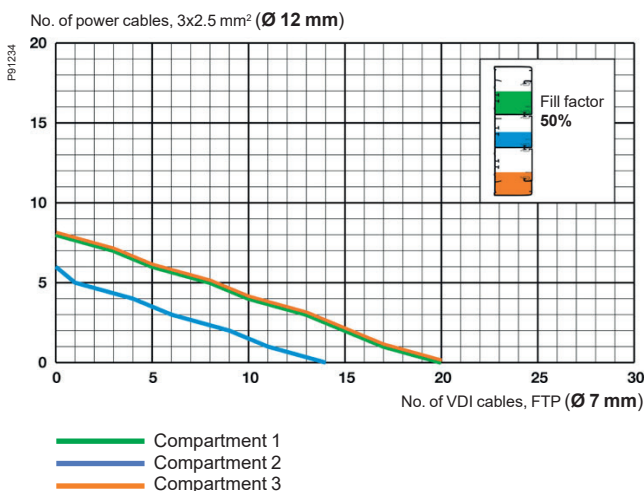











*A more detailed calculation can be made in the OptiLine system specification tool.*







# OptiLine 45 Trunking

## Choice guide

### Trunking and accessories

Trunking size	Trunking incl. separate front cover		Internal corner		External corner		Bend 90°		Stop end		Wall/ceiling frame	
	Ref. No.	Qty per pack	Ref. No.	Qty per pack	Ref. No.	Qty per pack	Ref. No.	Qty per pack	Ref. No.	Qty per pack	Ref. No.	Qty per pack
<b>PVC</b>												
75x55 	ISM10100P ISM10110P	24 m	ISM10101P	1	ISM10102P	1	ISM10103P	1	ISM10104P	2	ISM10105P	1
95x55 	ISM10200P	12 m	ISM10201P	1	ISM10202P	1	ISM10203P	1	ISM10204P	2	ISM10205P	1
140x55 	ISM10300P ISM10310P	12 m	ISM10301P	1	ISM10302P	1	ISM10303P	1	ISM10304P	2	ISM10305P	1
165x55 	ISM10400P	12 m	ISM10401P	1	ISM10402P	1	ISM10403P	1	ISM10404P	2	ISM10405P	1
185x55 	ISM10500P	8 m	ISM10501P	1	ISM10502P	1	ISM10503P	1	ISM10504P	2	ISM10505P	1
<b>Aluminium</b>												
75x55 	ISM10150	12 m	ISM10151	1	ISM10152	1	ISM10153	1	ISM10154	2	ISM10155	1
95x55 	ISM10250	12	ISM10251	1	ISM10252	1	ISM10253	1	ISM11254	2	ISM10255	1
140x55 	ISM10350	6 m	ISM10351	1	ISM10352	1	ISM10353	1	ISM10354	2	ISM10355	1
165x55 	ISM10450	6 m	ISM10451	1	ISM10452	1	ISM10453	1	ISM10454	2	ISM10455	1
185x55 	ISM10550	6 m	ISM10551	1	ISM10552	1	ISM10553	1	ISM10554	2	ISM10555	1

P=Polar white

 Joint cover piece, kit incl. jointing pieces		 T-piece single compartment feeder		 T-piece double compartment feeder		 Front cover PVC		 Front cover Alu		 Joint cover piece for front		 Jointing piece, internal	
Ref. No.	Qty per pack	Ref. No.	Qty per pack	Ref. No.	Qty per pack	Ref. No.	Qty per pack	Ref. No.	Qty per pack	Ref. No.	Qty per pack	Ref. No.	Qty per pack
ISM10106P	1	ISM10107P	1	–	–	ISM10900P	24 m	ISM10950	24 m	ISM10903P	5	ISM10904	10
ISM10206P	1	ISM10207P ISM10208P	1	–	1	ISM10900P	24 m	ISM10950	24 m	ISM10903P	5	ISM10904	10
ISM10306P	1	ISM10207P ISM10208P	1	ISM10308P	1	ISM10900P	24 m	ISM10950	24 m	ISM10903P	5	ISM10904	10
ISM10406P	1	ISM10207P ISM10208P	1	ISM10308P	1	ISM10900P	24 m	ISM10950	24 m	ISM10903P	5	ISM10904	10
ISM10506P	1	ISM10207P ISM10208P	1	ISM10308P	1	ISM10900P	24 m	ISM10950	24 m	ISM10903P	5	ISM10904	10
ISM10156	1	ISM10157	1	–	–	–	–	ISM10950	24 m	ISM10951	5	ISM10904	10
ISM10256	1	ISM10357 ISM10258	1	–	–	–	–	ISM10950	24 m	ISM10951	5	ISM10904	10
ISM10356	1	ISM10357 ISM10258	1	ISM10358	1	–	–	ISM10950	24 m	ISM10951	5	ISM10904	10
ISM10456	1	ISM10357 ISM10258	1	ISM10358	1	–	–	ISM10950	24 m	ISM10951	5	ISM10904	10
ISM10556	1	ISM10357 ISM10258	1	ISM10358	1	–	–	ISM10950	24 m	ISM10951	5	ISM10904	10



# OptiLine 45 Trunking Range

## PVC trunking

Type	Colour	Dimensions A/B/C (mm)	Qty per package	EAN code	Ref. No.
------	--------	-----------------------	-----------------	----------	----------

### Installation trunking

Installation trunking including one-compartment trunking base and front cover. The trunking base has pre-punched mounting holes every 25<sup>th</sup> cm and can be provided with cable shelves. 45 mm front opening for direct click-in of Unica 45x45 module wiring devices.

Trunking base and front cover are supplied unassembled under separate protective foil, in lengths of 2 m. Size 75 mm is also available in lengths of 3 m.

Material: PVC.

With one compartment	Polar white	75/55/2000	24 m	3606480681493	ISM10100P
		75/55/3000		3606480681578	ISM10110P

With one compartment	Polar white	95/55/2000	12 m	3606480681585	ISM10200P
----------------------	-------------	------------	------	---------------	-----------

Installation trunking including two or three-compartment trunking base and front covers. The trunking base has pre-punched mounting holes every 25<sup>th</sup> cm and can be provided with cable shelves. The integrated partition wall has pre-punched slots every 25<sup>th</sup> cm to facilitate cable laying. 45 mm front opening for direct click-in of Unica 45x45 module wiring devices.

Trunking base and front cover are supplied unassembled under separate protective foil, in lengths of 2 m. Size 140 mm is also available in lengths of 3 m.

Material: PVC.

With two compartments	Polar white	140/55/2000	12 m	3606480681677	ISM10300P
		140/55/3000		3606480681752	ISM10310P

With two compartments, the lower comp. for VDI appl.	Polar white	165/55/2000	12 m	3606480681769	ISM10400P
--	-------------	-------------	------	---------------	-----------

With three compartments	Polar white	185/55/2000	8 m	3606480681837	ISM10500P
-------------------------	-------------	-------------	-----	---------------	-----------

P85768



P85769



P85770



P85771

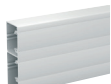

P85772



## Accessories for PVC trunking

### Internal corner

Adjustable internal corner for an 80–100 degree angling of PVC trunking.

Material: PC/ABS.

For trunking 75x55	Polar white	84/117/117	1	3606480681509	ISM10101P
For trunking 95x55	Polar white	104/117/117	1	3606480681592	ISM10201P
For trunking 140x55	Polar white	149/117/117	1	3606480681684	ISM10301P
For trunking 165x55	Polar white	174/117/117	1	3606480681776	ISM10401P
For trunking 185x55	Polar white	194/117/117	1	3606480681844	ISM10501P

### External corner

Adjustable external corner for a 75–135 degree angling of PVC trunking.

Material: PC/ABS.

For trunking 75x55	Polar white	84/105/105	1	3606480681516	ISM10102P
For trunking 95x55	Polar white	104/105/105	1	3606480681608	ISM10202P
For trunking 140x55	Polar white	149/105/105	1	3606480681691	ISM10302P
For trunking 165x55	Polar white	174/105/105	1	3606480681783	ISM10402P
For trunking 185x55	Polar white	194/105/105	1	3606480681851	ISM10502P

P89067



P89068



## Accessories for PVC trunking

Type	Colour	Dimensions A/B/C (mm)	Qty per package	EAN code	Ref. No.
<b>Bend, 90°, kit</b>					
90 degree bend kit for angling upwards and downwards of PVC trunking. Including bend piece and fixing device to be screw-fitted to the wall. Material: PC/ABS.					
For trunking 75x55	Polar white	102/57/102	1	3606480681523	ISM10103P
For trunking 95x55	Polar white	122/57/122	1	3606480681615	ISM10203P
For trunking 140x55	Polar white	167/57/167	1	3606480681707	ISM10303P
For trunking 165x55, only upwards angling	Polar white	192/57/192	1	3606480681790	ISM10403P
For trunking 185x55	Polar white	212/57/212	1	3606480681868	ISM10503P
<b>Stop end</b>					
Stop end for PVC trunking. Fast fitting with locking clips. Screw-fixing possible for extra security. Package of two. Material: PC/ABS.					
For trunking 75x55	Polar white	79/56/21	2	3606480681530	ISM10104P
For trunking 95x55	Polar white	99/56/21	2	3606480681622	ISM10204P
For trunking 140x55	Polar white	144/56/21	2	3606480681714	ISM10304P
For trunking 165x55	Polar white	169/56/21	2	3606480681806	ISM10404P
For trunking 185x55	Polar white	189/56/21	2	3606480681875	ISM10504P
<b>Wall/ceiling frame</b>					
Wall/Ceiling frame to be fitted around a PVC trunking at wall or ceiling passage. Easily modified to C or L-profile depending on how the passage is made. Snap-fitted, with a screw-fixing option for high security. Material: PC/ABS.					
For trunking 75x55	Polar white	130/82/22	1	3606480681547	ISM10105P
For trunking 95x55	Polar white	150/82/22	1	3606480681639	ISM10205P
For trunking 140x55	Polar white	195/82/22	1	3606480681721	ISM10305P
For trunking 165x55	Polar white	220/82/22	1	3606480681813	ISM10405P
For trunking 185x55	Polar white	240/82/22	1	3606480681882	ISM10505P
<b>Joint cover piece, kit</b>					
Joint cover piece, supplied and mounted together with two jointing pieces. Intended to cover joints between two PVC trunking sections. Easy to remove in case of an upgrading of the installation. Material: PC/ABS.					
For trunking 75x55	Polar white	80/57/100	1	3606480681554	ISM10106P
For trunking 95x55	Polar white	100/57/100	1	3606480681646	ISM10206P
For trunking 140x55	Polar white	145/57/100	1	3606480681738	ISM10306P
For trunking 165x55	Polar white	170/57/100	1	3606480681820	ISM10406P
For trunking 185x55	Polar white	190/57/100	1	3606480681899	ISM10506P

P85779



P85780



P85781









P85782







# OptiLine 45 Trunking Range

## Accessories for PVC trunking

Type	Colour	Dimensions A/B/C (mm)	Qty per package	EAN code	Ref. No.
<b>T-piece</b>					
T-piece intended to connect vertical and horizontal PVC trunking of various sizes. Material: PC/ABS.					
	For vertical trunking 75x55 and horizontal trunking 75x55	Polar white	42/57/97	1	3606480681561 ISM10107P
	For vertical trunking 75x55 and horizontal trunking 95x55, 140x55, 165x55 or 185x55	Polar white	52/57/97	1	3606480681653 ISM10207P
	For vertical trunking 95x55 and horizontal trunking 95x55, 140x55, 165x55 or 185x55	Polar white	52/57/117	1	3606480681660 ISM10208P
	For vertical trunking 140x55 and horizontal trunking 140x55, 165x55 or 185x55	Polar white	52/57/162	1	3606480681745 ISM10308P
<b>Front cover</b>					
Front cover to be snap-fitted in trunking with a 45 mm front opening. Supplied with protective foil, in lengths of 2 m. Material: PVC or aluminium.					
	Front cover, PVC	Polar white	45/16/2000	24 m	3606480681905 ISM10900P
	Front cover, aluminium, with earthing slots	Anodized	45/16/2000	24 m	3606480028489 ISM10950
<b>Cable retainer</b>					
Cable retainer to be mounted at the back of the trunking base to keep cables in place during the installation phase. No need to remove the retainer when fitting the front cover. Package of five. Material: PA.					
	Cable retainer	Green	32/42/25	5	3606480028403 ISM10901
<b>Cable shelf</b>					
Single cable shelf to be mounted in the trunking base, providing separation between power and low voltage cables. Supplied in lengths of 1 m. Material: PVC.					
	Cable shelf	White	17/47/1000	24 m	3606480028410 ISM10902
<b>Joint cover piece for front cover</b>					
Joint cover piece intended to cover joints between two front covers. Package of five. Material: PC/ABS.					
	Joint cover piece for PVC front cover	Polar white	47/20/23	5	3606480681929 ISM10903P
	Joint cover piece for aluminium front cover	Alu metallic	47/20/23	5	3606480028496 ISM10951
<b>Joining piece</b>					
Internal joining piece intended to facilitate jointing of two PVC trunking bases. May also be used to mount the joint cover piece. Package of ten. Material: PC/ABS.					
	Joining piece	White	4/51/100	10	3606480028441 ISM10904
<b>Sealing strip</b>					
Sealing strip to be fitted between trunking and floor for a 10-15 mm coverage. Material: PVC.					
	Sealing strip	Polar white	17/40/2000	24 m	3606480681943 ISM10905P

## Accessories for PVC trunking

Type	Colour	Dimensions A/B/C (mm)	Qty per package	EAN code	Ref. No.
<b>Front locking clip</b>					
Front locking clip to be mounted on either side of an outlet in order to secure pull-out forces. Package of ten. Material: PC/ABS.					
P85792					
Front locking clip	Polar white	45/23/23	10	3606489604141	ISM10909P
<b>Modular device adaptor</b>					
2-module adaptor for 1-2 modular devices like for instance miniature circuit breakers. With transparent grey cover. Material: PC+ASA.					
P85793					
Modular device adaptor	Polar white	90/72/45	1	3606480681950	ISM10907P
<b>Cutting shears</b>					
Cutting shears for PVC material. To be used when for instance cutting slots in the partition walls of PVC trunking (sizes 140 and 185) for easy cable laying between compartments. Also suitable when cutting front covers, cable shelves or other PVC length material, instead of using a saw. Material: Steel.					
P91380					
Cutting shears	Orange	230/22/80	1	3606480028472	ISM10908
<b>Label holder</b>					
Label holder for marking purposes. Package of ten. Material: PC/ABS.					
P144190 P144191					
P144192 P144199					
Label holder	White	23/23/45	10	3606489843021	ISM10920P
	Anthracite	23/23/45	10	3606489843038	ISM10921
	Alu metallic	23/23/45	10	3606489843045	ISM10922
	Red	23/23/45	10	3606490159319	ISM10923



# OptiLine 45 Trunking Range

## Aluminium trunking

Type	Colour	Dimensions A/B/C (mm)	Qty per package	EAN code	Ref. No.
<b>Installation trunking</b>					
Installation trunking including one, two or three-compartment trunking base and front cover(s). The trunking base has pre-punched mounting holes every 25 <sup>th</sup> cm and can be provided with cable shelves. 45 mm front opening for direct click-in of Unica 45x45 module wiring devices. Trunking base and front cover are supplied unassembled under separate protective foil, in lengths of 2 m. Material: Aluminium.					
With one compartment	Anodized	75/55/2000	12 m	3606480027789	ISM10150
With one compartment	Anodized	95/55/2000	12 m	3606485137728	ISM10250
With two compartments	Anodized	140/55/2000	6 m	3606480028021	ISM10350
With two compartments, the lower comp. for VDI appl.	Anodized	165/55/2000	6 m	3606480028182	ISM10450
With three compartments	Anodized	185/55/2000	6 m	3606480028328	ISM10550

P85773  
P111545  
P85774  
P85775  
P85776









## Accessories for aluminium trunking

<b>Internal corner</b>					
Adjustable internal corner for an 80–100 degree angling of aluminium trunking. Material: PC/ABS, painted.					
For trunking 75x55	Alu metallic	84/117/117	1	3606480027796	ISM10151
For trunking 95x55	Alu metallic	104/117/117	1	3606485137735	ISM10251
For trunking 140x55	Alu metallic	149/117/117	1	3606480028038	ISM10351
For trunking 165x55	Alu metallic	174/117/117	1	3606480028199	ISM10451
For trunking 185x55	Alu metallic	194/117/117	1	3606480028335	ISM10551
<b>External corner</b>					
Adjustable external corner for a 75–135 degree angling of aluminium trunking. Material: PC/ABS, painted.					
For trunking 75x55	Alu metallic	84/105/105	1	3606480027802	ISM10152
For trunking 95x55	Alu metallic	104/105/105	1	3606485137742	ISM10252
For trunking 140x55	Alu metallic	149/105/105	1	3606480028045	ISM10352
For trunking 165x55	Alu metallic	174/105/105	1	3606480028205	ISM10452
For trunking 185x55	Alu metallic	194/105/105	1	3606480028342	ISM10552
<b>Bend, 90°, kit</b>					
90 degree bend kit for angling upwards and downwards of aluminium trunking. Including bend piece and fixing device to be screw-fitted to the wall. Material: PC/ABS, painted.					
For trunking 75x55	Alu metallic	102/57/102	1	3606480027819	ISM10153
For trunking 95x55	Alu metallic	122/57/122	1	3606485137759	ISM10253
For trunking 140x55	Alu metallic	167/57/167	1	3606480028052	ISM10353
For trunking 165x55 only upwards angling	Alu metallic	192/57/192	1	3606480028212	ISM10453
For trunking 185x55	Alu metallic	212/57/212	1	3606480028359	ISM10553

P85797  
P85798  
P85799

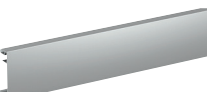

## Accessories for aluminium trunking

Type	Colour	Dimensions A/B/C (mm)	Qty per package	EAN code	Ref. No.
<b>Stop end</b>					
Stop end for aluminium trunking. Including screw and nut to fix the stop end in the trunking base. Material: PC/ABS, painted.					
 P85800	For trunking 75x55	Alu metallic	79/56/21	2	3606480027826 ISM10154
	For trunking 95x55	Alu metallic	99/56/21	2	3606480028823 ISM11254
	For trunking 140x55	Alu metallic	144/56/21	2	3606480028069 ISM10354
	For trunking 165x55	Alu metallic	169/56/21	2	3606480028229 ISM10454
	For trunking 185x55	Alu metallic	189/56/21	2	3606480028366 ISM10554
<b>Wall/Ceiling frame</b>					
Wall/Ceiling frame to be fitted around an aluminium trunking at wall or ceiling passage. Easily modified to C or L-profile depending on how the passage is made. Snap-fitted, with a screw-fixing option for high security. Material: PC/ABS, painted.					
 P85801	For trunking 75x55	Alu metallic	130/82/22	1	3606480027833 ISM10155
	For trunking 95x55	Alu metallic	150/82/22	1	3606485137766 ISM10255
	For trunking 140x55	Alu metallic	195/82/22	1	3606480028076 ISM10355
	For trunking 165x55	Alu metallic	220/82/22	1	3606480028236 ISM10455
	For trunking 185x55	Alu metallic	240/82/22	1	3606480028373 ISM10555
<b>Joint cover piece, kit</b>					
Joint cover piece, supplied and mounted together with two jointing pieces. Intended to cover joints between two aluminium trunking sections. Easy to remove in case of an upgrading of the installation. Material: PC/ABS, painted.					
 P85802	For trunking 75x55	Alu metallic	80/57/100	1	3606480027840 ISM10156
	For trunking 95x55	Alu metallic	100/57/100	1	3606485137773 ISM10256
	For trunking 140x55	Alu metallic	145/57/100	1	3606480028083 ISM10356
	For trunking 165x55	Alu metallic	170/57/100	1	3606480028243 ISM10456
	For trunking 185x55	Alu metallic	190/57/100	1	3606480028380 ISM10556
<b>T-piece</b>					
T-piece intended to connect vertical and horizontal aluminium trunking of various sizes. Material: PC/ABS, painted.					
 P85804	For vertical trunking 75x55 and horizontal trunking 75x55	Alu metallic	42/57/97	1	3606480027857 ISM10157
	For vertical trunking 75x55 and horizontal trunking 95x55, 140x55, 165x55 or 185x55	Alu metallic	52/57/97	1	3606480028090 ISM10357
	For vertical trunking 95x55 and horizontal trunking 95x55, 140x55, 165x55 or 185x55	Alu metallic	52/57/117	1	3606480160561 ISM10258
	For vertical trunking 140x55 and horizontal trunking 140x55, 165x55 or 185x55	Alu metallic	52/57/162	1	3606480028106 ISM10358
<b>Front cover</b>					
Front cover to be snap-fitted in trunking with a 45 mm front opening. With earthing slots. Supplied with protective foil, in lengths of 2 m. Material: Aluminium.					
 P85786	Front cover	Anodized	45/16/2000	24 m	3606480028489 ISM10950
<b>Cable retainer</b>					
Cable retainer to be mounted at the back of the trunking base to keep cables in place during the installation phase. No need to remove the retainer when fitting the front cover. Package of five. Material: PA.					
 P85787	Cable retainer	Green	32/42/25	5	3606480028403 ISM10901
<b>Cable shelf</b>					
Single cable shelf to be mounted in the trunking base, providing separation between power and low voltage cables. Supplied in lengths of 1 m. Material: PVC.					
 P85788	Cable shelf	White RAL 9010	17/47/1000	24 m	3606480028410 ISM10902

# OptiLine 45 Trunking Range

## Accessories for aluminium trunking



Type	Colour	Dimensions A/B/C (mm)	Qty per package	EAN code	Ref. No.
<b>Joint cover piece for front cover</b>					
Joint cover piece intended to cover joints between two aluminium front covers. Package of five. Material: PC/ABS, painted.					
Joint cover piece	Alu metallic	46/20/23	5	3606480028496	ISM10951
<b>Jointing piece</b>					
Internal jointing piece intended to facilitate jointing of two aluminium trunking bases. May also be used to mount the joint cover piece. Package of ten. Material: PC/ABS.					
Jointing piece	White	4/51/100	10	3606480028441	ISM10904
<b>Jointing/earthing piece</b>					
Internal jointing and earthing piece, intended for jointing and earthing of two aluminium trunking bases. Including two screws. Material: Zinc.					
Jointing/earthing piece	Untreated	4/6/26	10	3606480028533	ISM10955
<b>Sealing strip</b>					
Sealing strip to be fitted between trunking and floor for a 10-15 mm coverage. Material: PVC.					
Sealing strip	Polar white	17/40/2000	24 m	3606480681943	ISM10905P
<b>Modular device adaptor</b>					
2-module adaptor for 1-2 modular devices like for instance miniature circuit breakers. With transparent grey cover. Material: PC+ASA.					
Modular device adaptor	Alu metallic	90/72/45	1	3606480028540	ISM10957
<b>Earthing clamp</b>					
Earthing clamp to be used for bonding of front cover, trunking base and accessories to earth. Package of ten. Material: Steel.					
Earthing clamp	—	9/9/9	20	3606480028502	ISM10952
<b>Earthing kit</b>					
Kit including earth wire with flat pin connectors and earthing clamps. To be used to connect the front cover to the base profile or the base profile to another base profile.					
Earthing kit	Yellow/green	L = 200	10	3606480028519	ISM10953
		L = 300	10	3606480028526	ISM10954
<b>Front locking clip</b>					
Front locking clip to be mounted on either side of an outlet in order to secure pull-out forces. Package of ten. Material: PC/ABS.					
Front locking clip	Polar white	45/23/23	10	3606489604141	ISM10909P
<b>Label holder</b>					
Label holder for marking purposes. Package of ten. Material: PC/ABS.					
Label holder	White	23/23/45	10	3606489843021	ISM10920P
	Anthracite	23/23/45	10	3606489843038	ISM10921
	Alu metallic	23/23/45	10	3606489843045	ISM10922
	Red	23/23/45	10	3606490159319	ISM10923

## Fixing products

Type	Colour	Dimensions (mm)	Qty per package	EAN code	Ref. No.
<b>Wall plugs</b>					
Wall plug on sprue plate, suitable for use in concrete, stone, lightweight concrete, expanded clay, hollow bricks, solid bricks and plasterboard. Material: PE-HD.					
TP 2	Red	Ø5.5x35	100	7315881003006	1003003
TP 2B	Brown	Ø8x40	100	7315881005000	1005008
TP 3	Blue	Ø10x45	10	3606480621369	IMT48002
Same as above but single. Material: PE-HD.					
TP 6	Red	Ø6x30	100	7315881003020	1003020
<b>Nail plugs</b>					
Nail plug including nail for through installation. Suitable for use in concrete, stone, lightweight concrete, expanded clay, hollow bricks, solid bricks and plasterboard. Material: PA.					
TPS-6/5x35	Clear	Drill Ø6	100	7315881150007	1150002
TPS-6/20x50	Clear	Drill Ø6	100	7315880100027	1150051
<b>Installation screws</b>					
Screw with large thin head and integrated washer. Phillips cross recess. Twin thread. Fully threaded. Gives very good pressure when fixing plastic trunking. Material: Hardened steel, electroplated.					
TSC-32	—	Ø4.2x25	100	7315883782022	3782020
TSC-33	—	Ø4.2x31	100	7315883782039	3782030
Screw with raised countersunk head, Phillips cross recess. Fully threaded. Suitable for mounting directly into plasterboard. Material: Steel, electroplated.					
TSF-25	—	Ø4.8x25	100	7315883782428	3782420
TSF-35	—	Ø4.8x35	100	7315883782435	3782430
TSF-45	—	Ø4.8x45	100	7315883782442	3782440
<b>Installation screw with cup washer</b>					
Screw with cross-slotted head type PH2. Sharp point, fully threaded. High pitch for quick mounting. Provided with a cup washer for screw-head protection. To be used when installing single-insulated wire in the trunking. Material: Hardened steel, electroplated, and PP.					
TFT-IS5x32	—	Ø5x32	100	7332418018203	4020210

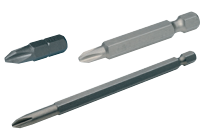

## Fixing products

Type	Colour	Dimensions (mm)	Qty per package	EAN code	Ref. No.
<b>Cavity fixings</b>					
Cavity fixing with metal toggle for high load values. Material: Zinc/Steel.					
 <small>PB0837</small>	TPP-10xM4S	—	Drill Ø10	25	7315881200009 1200005
	TPP-13xM5S	—	Drill Ø13	25	7315881200405 1200401
Cavity fixing for light installations in plasterboard. Board thickness from 9 mm. Screw size 4.5x35. Material: Zinc.					
 <small>PB9047</small>	TPD-Metal	—	Screw size 4.5x35	100	7315880114291 1220104
Cavity fixing including a 38 mm long screw. The shape of THW prevents it from rotating. No pre-drilling needed, just hammer in. Excellent for porous and thin material. Pull-out load 100 N, safety factor 3, shear load 100N, safety factor 2.5. Board thickness 6-13 mm, max. thickness of fixture 16 mm. Material: Steel, electroplated.					
 <small>PB1678</small>	THW 4.2x38	—	—	50	7315881260171 1260170
<b>Screw bits</b>					
1/4 hexagon drive end, various lengths (25, 50 or 110 mm, see below). Adapted to the Thorsman range of installation screws with Phillips cross recess. Material: Hardened steel.					
 <small>PB0841 PB1679 PB9048</small>	PH 2x25	—	1/4"x25	2	7315881772056 1772054
	PH 2x25 Reduced	—	1/4"x25	2	7315880056294 1772052
	PH 2x50	—	1/4"x50	2	7315880055273 1772056
	PH 2x110	—	1/4"x110	2	7315880055297 1772058

### Design and dimensions

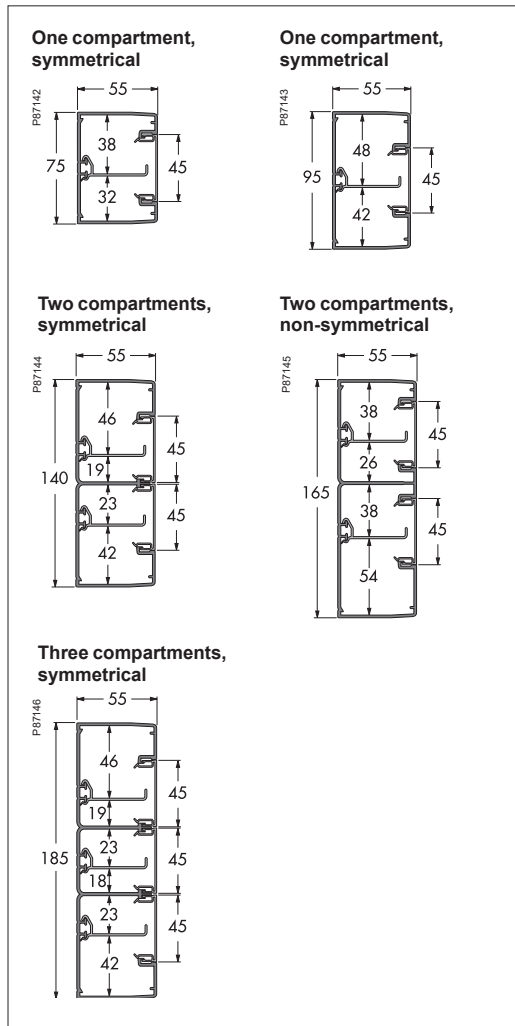

### Technical and Material data

PVC (self-extinguishing, lead and cadmium-free)	Fire rating	UL 94 V0 (0.8 mm)
Aluminium	Colour	Polar white (RAL 9003)
PC/ABS	Surface treatment	Natural anodizing
	Fire rating	UL 94 HB
	Colours	<ul style="list-style-type: none"> <li>• Polar white (RAL 9003)</li> <li>• Aluminium metallic (painted)</li> </ul>
PA (polyamide), halogen-free	Fire rating	UL 94 V0
	Colours	<ul style="list-style-type: none"> <li>• Green</li> <li>• Clear</li> </ul>
PC+ASA	Fire rating	UL 94 HB
	Colours	<ul style="list-style-type: none"> <li>• Polar white (RAL 9003)</li> <li>• Aluminium metallic</li> </ul>
PE (polyethylene), halogen-frees	Fire rating	UL 94 HB
	Colours	<ul style="list-style-type: none"> <li>• Red</li> <li>• Brown</li> <li>• Black</li> </ul>
Degree of protection	IP40	
Temperature range	Operating temperature from -25°C to +60°C	
Resistance to impact	PVC trunking	2J (IK07)
	PC/ABS accessories	2J (IK07)
Standards and certificates	The products comply with the standards: <ul style="list-style-type: none"> <li>• EN 50085-1:2005</li> <li>• pr EN 50085-2-1:2002</li> <li>• NFC 68 102:1990 (French national standard)</li> </ul> The products satisfy the provisions for CE marking according to the Low Voltage Directive 73/23/EEC and 93/68/EEC.	

### Exploded view

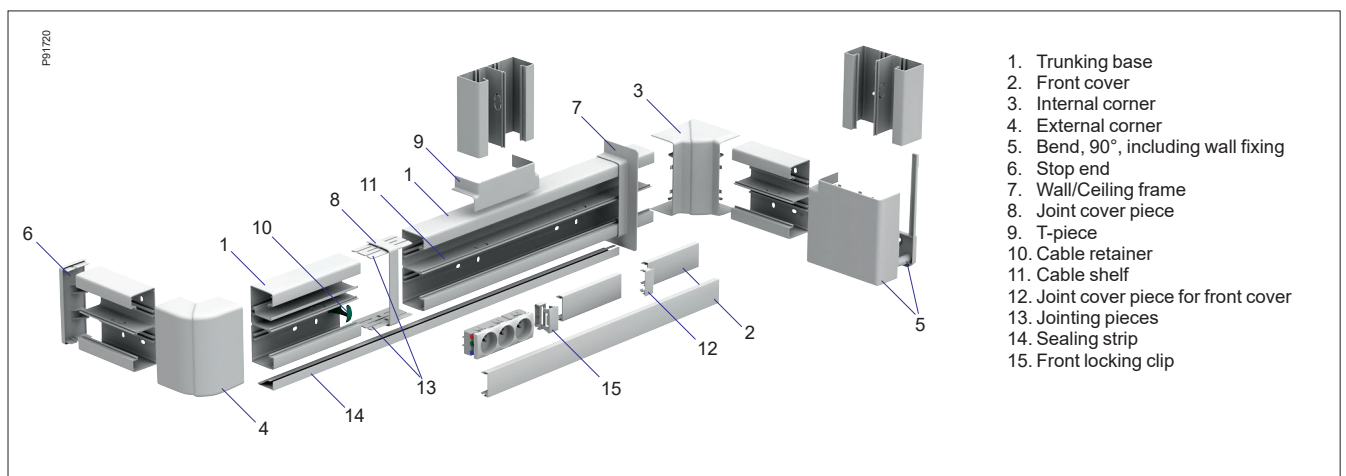

# OptiLine 45 Poles

## Presentation



### Service poles with 45 mm front opening for direct click-in of Unica wiring devices

OptiLine 45 service poles with a 45 mm front opening offer very flexible installation solutions, bringing power, telecom and data directly from the ceiling to the desk.

The poles have a softly rounded and slender form and are made of aluminium with a high surface finish, either natural anodised or powder coated white. They are installed free-standing in the room mounted on a foot and movable within a radius of up to 1.5 metres from the connection point in the ceiling, or tension-mounted between floor and ceiling. Both types are available in one and two-sided versions, or with four boxes.

The spring-loaded and adjustable ceiling fixing for tension-mounted poles can be fitted easily without tools.



#### One-sided poles

Free-standing



P86536

P87200

Alu

White



Tension-mounted



P86538

P87199

Alu

White

#### Two-sided poles

Free-standing



P86535

P87201

Alu

White



Tension-mounted



P86537

P87199

Alu

White

#### With boxes

Free-standing



P117513

P117514

Alu

White



Tension-mounted

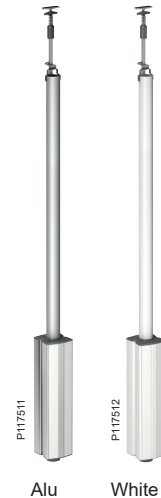

P117511

P117512

Alu

White



### Unica 45x45 module wiring devices

The OptiLine 45 range has a front opening for direct click-in of Unica 45x45 module wiring devices which gives optimal function and design.

Unica offers a broad range of socket outlets, switches, VDI outlets and electronic products such as dimmers, movement detectors, thermostats, timers.

# OptiLine 45 Poles Presentation

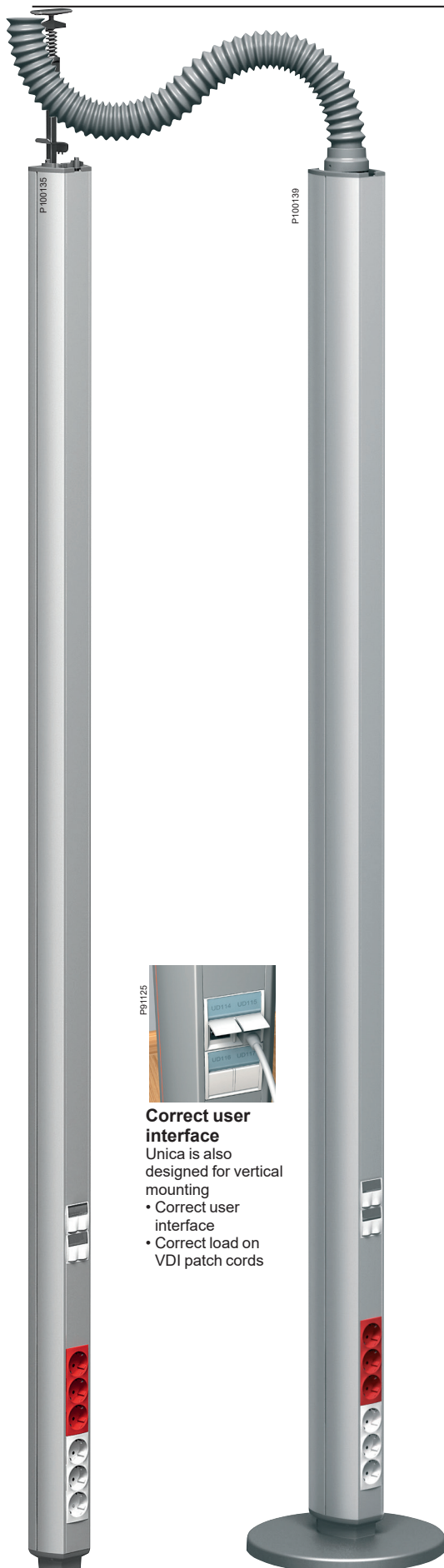

### Design, finish and quality

All OptiLine poles are made of aluminium, anodized or powder coated, with a high surface finish. The form is softly rounded and slender. All parts are designed to give reliable function and easy installation.

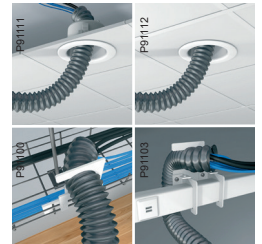
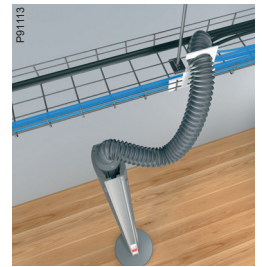

### Many mounting options

Accessories for all mounting options. The ceiling frame for the flexible conduit is mounted without a tool and can be adjusted to different ceiling thicknesses.

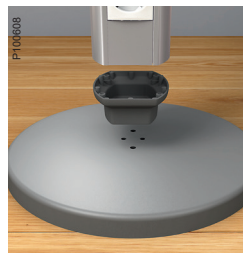

### Stable and sturdy

All parts in aluminium, several are die-cast. Foot in sand-cast iron.

- Stable and sturdy design
- Reliable function
- High-quality impression.



### Innovative square foot

The foot has a steel clamp that can be unfolded for extra support.

- Steady
- Nice installation close to the wall
- Two poles can be placed back to back.

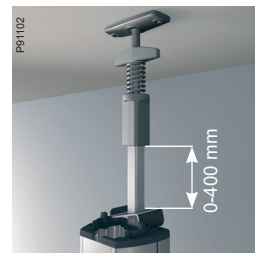

### Handy ceiling fixing

Fitted easily without tools.

Self-locking adjustment.

- Quick and safe installation
- 400 mm working range
- Mechanism outside the pole – does not interfere with the wiring devices.



### Correct user interface

Unica is also designed for vertical mounting

- Correct user interface
- Correct load on VDI patch cords

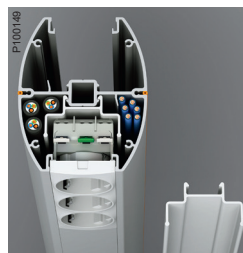

### Cable separation

Partition profile for good separation of cables.

- Correct distance between VDI and power cables
- Full isolation between terminations and cables.



### Screw slots

Slots along both sides of the pole.

- For decorative colour strips
- For products like spotlights, small shelves etc.

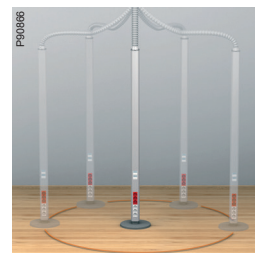

### Flexibility

The movable pole has a steady foot and a flexible conduit.

- Easy to move the poles to optimize the office layout
- 1.5 m action radius.















### Smooth stop-end

Stop end in cast aluminium with smoothly shaped edges.

- Covers the sharp cut of the base profile
- No risk of damaged cables.

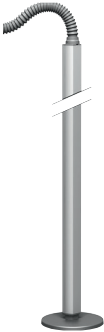

## OptiLine 45 Poles & accessories Choice guide

Quantity per pack: 1									
<b>Tension-mounted</b>			<b>Height mm</b>	<b>Anodized aluminium</b>	<b>Polar white</b>				
	<b>One-sided</b> 		2700-3100 3100-3500 3500-3900 3900-4300	ISM20100 ISM20102 ISM20104 ISM20120	ISM20101P ISM20103P ISM20105P ISM20121P	ISM20810P		ISM20814	
	<b>Two-sided</b> 		2700-3100 3100-3500 3500-3900 3900-4300	ISM20106 ISM20108 ISM20110 ISM20122	ISM20107P ISM20109P ISM20111P ISM20123P		ISM20811P	ISM20814	
<b>Tension-mounted with installation boxes</b>			<b>Height mm</b>	<b>Anodized aluminium</b>	<b>Polar white</b>				
			2700-3100 3100-3500 3500-3900	ISM20140 ISM20142 ISM20144	ISM20141P ISM20143P ISM20145P	ISM20552P		ISM20554	
<b>Free-standing</b>			<b>Height mm</b>	<b>Anodized aluminium</b>	<b>Polar white</b>				
	<b>One-sided</b> 		2150 2450 2900	ISM20130 ISM20112 ISM20114	ISM20131P ISM20113P ISM20115P				
	<b>Two-sided</b> 		2150 2450 2900	ISM20132 ISM20116 ISM20118	ISM20133P ISM20117P ISM20119P				
<b>Free-standing with installation boxes</b>			<b>Height mm</b>	<b>Anodized aluminium</b>	<b>Polar white</b>				
			2150 2450 2900	ISM20146 ISM20148 ISM20150	ISM20147P ISM20149P ISM20151P				



 Foot, round	 Foot, rectangular	 Ceiling frame	 Ceiling fixing	 Busbar fixing	 Cable tray fixing
ISM20808	ISM20809	ISM20812P	ISM20816	ISM20815	ISM20813
ISM20808	ISM20809	ISM20812P	ISM20816	ISM20815	ISM20813
ISM20808	ISM20809	ISM20812P	ISM20816	ISM20815	ISM20813

# OptiLine 45 Poles Range

## Poles, empty

Type	Colour	Dimensions A/B/C (mm)	Qty per package	EAN code	Ref. No.
------	--------	-----------------------	-----------------	----------	----------

### Pole, tension-mounted

Empty pole for tension mounting between floor and ceiling, one-sided or two-sided. Including front cover, ceiling fixing, ceiling frame, stop end, strain relief, partition profile, floor fixing plate, earthing kit and mounting instruction. Adjustability of ceiling fixing 400 mm. Unearthed. Supplied without service content or cables. 45 mm front opening for direct click-in of Unica 45x45 module wiring devices.

Material: Aluminium, natural anodized or powder coated white.

One-sided, 2.7-3.1 m	Anodized	3100/68/89	1	3606480029561	ISM20100
	Polar white			3606480681974	ISM20101P
One-sided, 3.1-3.5 m	Anodized	3500/68/89	1	3606480029585	ISM20102
	Polar white			3606480681981	ISM20103P
One-sided, 3.5-3.9 m	Anodized	3900/68/89	1	3606480029608	ISM20104
	Polar white			3606480681998	ISM20105P
One-sided, 3.9-4.3 m	Anodized	4300/68/89	1	3606480317262	ISM20120
	Polar white			3606480682070	ISM20121P
Two-sided, 2.7-3.1 m	Anodized	3100/116/90	1	3606480029622	ISM20106
	Polar white			3606480682001	ISM20107P
Two-sided, 3.1-3.5 m	Anodized	3500/116/90	1	3606480029646	ISM20108
	Polar white			3606480682018	ISM20109P
Two-sided, 3.5-3.9 m	Anodized	3900/116/90	1	3606480029660	ISM20110
	Polar white			3606480682025	ISM20111P
Two-sided, 3.9-4.3 m	Anodized	4300/116/90	1	3606480317286	ISM20122
	Polar white			3606480682087	ISM20123P

### Pole, tension-mounted, with installation boxes

Empty pole for tension mounting between floor and ceiling, provided with four installation boxes. Installation box height 558 mm. Including white plastic front cover, ceiling fixing, ceiling frame, stop end, floor fixing, floor fixing plate (zinc), earthing cable and mounting instruction. Adjustability of ceiling fixing 400 mm. Unearthed. Supplied without service content or cables. 45 mm front opening for direct click-in of Unica 45x45 module wiring devices.

Material: Aluminium, natural anodized or powder coated white.

2.7-3.1 m	Anodized	2700-3100/149/140	1	3606480317347	ISM20140
	Polar white			3606480682117	ISM20141P
3.1-3.5 m	Anodized	3100-3500/149/140	1	3606480317361	ISM20142
	Polar white			3606480682124	ISM20143P
3.5-3.9 m	Anodized	3500-3900/149/140	1	3606480317385	ISM20144
	Polar white			3606480682131	ISM20145P

### Pole, free-standing

Empty, free-standing and movable pole, one-sided or two-sided. Including front cover, flexible conduit with adaptor, strain relief, partition profile, earthing kit and mounting instruction. Unearthed. Supplied without service content or cables. 45 mm front opening for direct click-in of Unica 45x45 module wiring devices. Length of flexible conduit 2 m, action radius 1.5 m from the connection point in the ceiling. Foot to be ordered separately.

Material: Aluminium, natural anodized or powder coated white.

One-sided, 2.15 m	Anodized	2150+2000/68/89	1	3606480317309	ISM20130
	Polar white			3606480682094	ISM20131P
One-sided, 2.45 m	Anodized	2450+2000/68/89	1	3606480029684	ISM20112
	Polar white			3606480682032	ISM20113P
One-sided, 2.9 m	Anodized	2900+2000/68/89	1	3606480029707	ISM20114
	Polar white			3606480682049	ISM20115P
Two-sided, 2.15 m	Anodized	2150+2000/116/90	1	3606480317323	ISM20132
	Polar white			3606480682100	ISM20133P
Two-sided, 2.45 m	Anodized	2450+2000/116/90	1	3606480029721	ISM20116
	Polar white			3606480682056	ISM20117P
Two-sided, 2.9 m	Anodized	2900+2000/116/90	1	3606480029745	ISM20118
	Polar white			3606480682063	ISM20119P

P86538  
P87199



P117511  
P117512



P86536  
P87201



# OptiLine 45 Poles Range

## Poles, empty

P117513  
P117514



Type	Colour	Dimensions A/B/C (mm)	Qty per package	EAN code	Ref. No.
<b>Pole, free-standing, with installation boxes</b>					
Empty, free-standing and movable pole, provided with four installation boxes. Installation box height 558 mm. Including white plastic front cover, flexible conduit with adaptor, earthing cable and mounting instruction. Unearthed. Supplied without service content or cables. 45 mm front opening for direct click-in of Unica 45x45 module wiring devices. Length of flexible conduit 2 m, action radius 1.5 m from the connection point in the ceiling. Foot to be ordered separately. Material: Aluminium, natural anodized or powder coated white.					
2.15 m	Anodized Polar white	2150+2000/149/140	1	3606480317408 3606480682148	ISM20146 ISM20147P
2.45 m	Anodized Polar white	2450+2000/149/140	1	3606480317422 3606480682155	ISM20148 ISM20149P
2.9 m	Anodized Polar white	2900+2000/149/140	1	3606480317446 3606480682162	ISM20150 ISM20151P

## Pre-wired Poles

P135068  
P140080



<b>One-sided Pole</b>					
Free-standing and movable service pole, one-sided. Pre-wired, configured with 3 x double outlets, side-earthed, with cable, and 2 x Cat 6 UTP with cable. Including front cover, flexible conduit with adaptor, strain relief and mounting instruction. Length of flexible conduit 2.0 m, action radius 1.5 m from the connection point in the ceiling. Earthed. Foot to be ordered separately. External cables: one unshielded 3 x 1.5 mm <sup>2</sup> cable with side-earthed plug, 2.0 m free length, and two Cat 6 UTP data cables with RJ45 plugs, 6.0 m free length.					
One-sided Pole	White	Aluminum	2150+2000/68/89	1	ISM22204
2 x Cat 6 UTP	Anodized	Aluminum	2150+2000/68/89	1	ISM22205
Free-standing and movable service pole, one-sided. Pre-wired, configured with 3 x double outlets, side-earthed, with cable, and 2 x Cat 6A S/FTP with cable. Including front cover, flexible conduit with adaptor, strain relief and mounting instruction. Length of flexible conduit 2.0 m, action radius 1.5 m from the connection point in the ceiling. Earthed. Foot to be ordered separately. External cables: one unshielded 3 x 1.5 mm <sup>2</sup> cable with side-earthed plug, 2.0 m free length, and two Cat 6A S/FTP data cables with RJ45 plugs, 6.0 m free length.					
One-sided Pole	White	Aluminum	2150+2000/68/89	1	ISM22206
2 x Cat 6A S/FTP	Anodized	Aluminum	2150+2000/68/89	1	ISM22207











P140082  
P135061



<b>Two-sided Pole</b>					
Free-standing and movable service pole, two-sided. Pre-wired, each side configured with 3 x double outlets, side-earthed, with cable, and 2 x Cat 6 UTP with cable. Including front cover, flexible conduit with adaptor, strain relief and mounting instruction. Length of flexible conduit 2.0 m, action radius 1.5 m from the connection point in the ceiling. Earthed. Foot to be ordered separately. External cables: one unshielded 3 x 1.5 mm <sup>2</sup> cable with side-earthed plug, 2.0 m free length, and four Cat 6 UTP data cables with RJ45 plugs, 6.0 m free length.					
Two-sided Pole	White	Aluminum	2150+2000/116/90	1	ISM22208
2 x Cat 6 UTP	Anodized	Aluminum	2150+2000/116/90	1	ISM22209
Free-standing and movable service pole, two-sided. Pre-wired, each side configured with 3 x double outlets, side-earthed, with cable, and 2 x Cat 6A S/FTP with cable. Including front cover, flexible conduit with adaptor, strain relief and mounting instruction. Length of flexible conduit 2.0 m, action radius 1.5 m from the connection point in the ceiling. Earthed. Foot to be ordered separately. External cables: one unshielded 3 x 1.5 mm <sup>2</sup> cable with side-earthed plug, 2.0 m free length, and four Cat 6A S/FTP data cables with RJ45 plugs, 6.0 m free length.					
Two-sided Pole	White	Aluminum	2150+2000/116/90	1	ISM22210
2 x Cat 6A S/FTP	Anodized	Aluminum	2150+2000/116/90	1	ISM22211



## Accessories for poles

P86528		<b>Foot for free-standing, movable pole</b>					
		Rectangular foot for free-standing, movable pole, to be fixed to the bottom plate of the pole by means of two M6 bolts (included). The foot is provided with a steel clamp that can be unfolded for extra support. When not in use, the clamp lies protected in a recess underneath the foot. Specially suited in applications close to the wall or when two poles are positioned back to back. Material: Cast iron, painted.					
		Foot, rectangular	Grey	33/250/346	1	3606480030598	ISM20809
P86529		<b>Round foot for free-standing, movable poles</b>					
		Round foot for free-standing, movable poles, to be fixed to the bottom plate of the pole by means of two M6 bolts (included). Suitable both for one and two-sided poles. Material: Cast iron, painted.					
		Foot, round	Grey	29/Ø317	1	3606480030581	ISM20808
P86527		<b>Ceiling frame</b>					
		Ceiling frame intended to lead flexible conduit through false ceiling. To be mounted in circular hole, Ø125 mm, by using three included clamps. Also including a slotted plastic plate to be used to lock the flexible conduit, which is fixed by cable ties. The plate can also be used as a drill template for entrance hole Ø125 mm. Material: PC/ABS.					
		Ceiling frame	Polar white	89/Ø161	1	3606480682216	ISM20812P
P86532		<b>Ceiling frame</b>					
		Ceiling frame for one-sided or two-sided poles. Covers the edge of the hole in a false ceiling. Self-sticking. Material: PS (polystyrene).					
		Ceiling frame for 1-sided pole	Polar white	1/108/129	1	3606480682193	ISM20810P
P86531		<b>Ceiling frame for 2-sided pole</b>					
		Ceiling frame for 2-sided pole. Covers the edge of the hole in a false ceiling. Self-sticking. Material: PS (polystyrene).					
		Ceiling frame for 2-sided pole	Polar white	1/156/130	1	3606480682209	ISM20811P
P92648		<b>Ceiling frame for Ø65 mm pole</b>					
		Ceiling frame for Ø65 mm pole. Covers the edge of the hole in a false ceiling. Self-sticking. Material: PS (polystyrene).					
		Ceiling frame for Ø65 mm pole	Polar white	1/Ø115	1	3606480682902	ISM20552P
P86524		<b>Cable tray fixing</b>					
		Cable tray fixing including fixing material, intended to connect flexible conduit to cable tray. Gripping around cable tray. Material: Steel, powder coated.					
		Cable tray fixing	White	100/15/70	1	3606480030635	ISM20813
P86530		<b>Cable tray fixing with screws</b>					
		Cable tray fixing to be clamped onto the edge of a cable tray or feeder trunking in the ceiling. Including screws. Can be mounted anywhere along the pole length. The height is adjustable by ±15 mm. Maximum material thickness of tray/trunking at fixing point = 10 mm. Material: Aluminium, powder coated.					
		Cable tray fixing	White	75/50/120	1	3606480030642	ISM20814
P86526		<b>Ceiling fixing</b>					
		Ceiling fixing intended to connect flexible conduit to ceiling or wall. Fixings not included. Material: Aluminium, powder coated.					
		Ceiling fixing	White	50/156/90	1	3606480030666	ISM20816
P94903		<b>Busbar fixing</b>					
		Busbar fixing for Ø55 mm conduits, intended to connect flexible conduit to busbar trunking. Material: Steel, powder coated.					
		Busbar fixing	White	105/90/70	1	3606480030659	ISM20815
P94375		<b>Floor fixing plate</b>					
		Fixing plate to fix tension-mounted poles to the floor by screws. Fixed to the pole by pegs. Material: Steel, electroplated.					
		Floor fixing plate	—	13/49/60	1	3606480567438	ISM20828

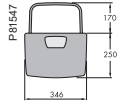

## Accessories for service poles

Type	Colour	Dimensions <sup>a</sup> A/B/C (mm)		Qty per package	EAN code	Ref. No.
<b>Wall bracket</b>						
Upper wall bracket for poles with one or two boxes. Screws for fixing the pole are included. Material: Steel, powder coated white RAL 9010 or grey.						
Upper wall bracket	White	38/51/57		1	3606481213846	INS40480
Upper wall bracket	Grey	38/51/57		1	3606481218957	INS40483
<b>Wall bracket</b>						
Upper wall bracket for one-sided poles. Screws for fixing the pole are included. Material: Steel, powder coated white RAL 9010 or grey						
Upper wall bracket for one-sided pole	White	38/42/94		1	3606481213853	INS40481
Upper wall bracket for one-sided pole	Grey	38/42/94		1	3606481218964	INS40484
Upper wall bracket for one-sided poles. The pole will be positioned 25 mm from the wall to avoid interference with false ceiling frames. Screws for fixing the pole are included. To be used together with lower wall bracket INS40486. Material: Steel, powder coated.						
Upper wall bracket for Optiline 45 and 50 poles	White	38/56/94		1	3606489938505	INS40485
<b>Lower wall/floor bracket</b>						
Lower wall/floor bracket for Optiline 50 poles. For one-sided poles and poles with one or two boxes. Material: Steel, powder coated grey.						
Lower wall/floor bracket	Grey	43/67/40		1	3606481213860	INS40482
Lower wall bracket for one-sided poles and poles with one or two boxes. The pole will be positioned 25 mm from the wall to avoid interference with false ceiling frames. To be used together with upper wall bracket INS40485. Material: Steel, powder coated.						
Lower wall bracket for Optiline 45 and 50 poles	Grey	43/80/40		1	3606489938512	INS40486

P152507



P152508



Wall\_bracket



P152506













Lower\_wall\_floor\_bracket



# OptiLine 45 Poles Range

## Accessories for poles

Type	Colour	Dimensions A/B/C (mm)	Qty per package	EAN code	Ref. No.
<b>Front cover</b>					
Front cover to be snap-fitted in service carriers with a 45 mm front opening. With earthing slots. Supplied with protective foil, in lengths of 2 m. Material: Aluminium, natural anodized or powder coated white.					
P92658 	Anodized	45/16/2000	24 m	3606480028489	ISM10950
P92659 	Polar white	45/16/2000	24 m	3606480682179	ISM10960P
<b>Floor fixing with slot for floor feeder</b>					
Floor fixing for one or two-sided pole. Fixed to the floor by screws. With slot for connection of floor feeder 18x75 mm. Material: Aluminium, powder coated.					
P97198 	Grey	38/125/102	1	3606480030703	ISM20820
P97189 	Grey	38/125/156	1	3606480030710	ISM20821
<b>Floor feeder</b>					
Floor feeder made up by a base part with three compartments and a cover. Supplied in lengths of 2 m. To be used for feeding along the floor to a pole provided with a slotted floor fixing for 18x75 mm floor feeder. Material: PVC.					
P96523 	Grey	18/75/2000	28 m	3606480030673	ISM20817
Floor feeder made up by a base part with three compartments and a cover. Supplied in lengths of 2 m. To be used for feeding along the floor to a pole provided with a slotted floor fixing for 18x75 mm floor feeder. Material: Aluminium, natural anodized.					
P111399 	Anodized	18/75/2000	8 m	3606480027536	ISM20857
<b>Floor feeder jointing piece</b>					
Floor feeder jointing piece to cover joints between floor feeder sections. Material: PVC.					
P96521 	Grey	20/50/78	10	3606480030680	ISM20818
<b>Corner feeder piece</b>					
Corner feeder piece to be used in 90 degree corners between floor feeder sections. Material: PVC.					
P96522 	Grey	20/120/120	10	3606480030697	ISM20819
<b>Floor feeder adaptor</b>					
Adaptor to be used between floor feeder and wall trunking with a 45 mm front opening. Material: PC/ABS.					
P97196 	Polar white	60/63/110	1	3606480682278	ISM20826P
P97187 	Alu metallic	60/63/110	1	3606480030772	ISM20827
<b>Partition profile</b>					
Partition profile of halogen-free material with two partition walls. Mounted in internal fixing rails of poles and posts. Supplied in lengths of 0.5 m. Material: ABS.					
P97194 	White	500/30/52	10	3606480030758	ISM20825

# OptiLine 45 Poles Range

## Accessories for poles

Type	Colour	Dimensions A/B/C (mm)	Qty per package	EAN code	Ref. No.
<b>Decorative stripe</b>					
Decorative stripe to be fitted in the slots along the sides of poles and posts. Supplied in lengths of 5 m. Material: Silicone rubber.					
Decorative stripe	Grey	5000/Ø3.5	5 m	3606480030727	ISM20822
Decorative stripe	Polar white	5000/Ø3.5	5 m	3606480682261	ISM20823P
Decorative stripe	Orange	5000/Ø3.5	5 m	3606480030741	ISM20824
<b>Earthing clamp</b>					
Earthing clamp to be used for bonding of front cover, base profile and accessories to earth. Material: Steel.					
Earthing clamp	—	9/9/9	20	3606480028502	ISM10952
<b>Earthing kit</b>					
Kit including earth wire with flat pin connectors and earthing clamps. To be used to connect the front cover to the base profile.					
Earthing kit	Yellow/green	L = 200 L = 300	10 10	3606480028519 3606480028526	ISM10953 ISM10954
<b>Modular device adaptor</b>					
2-module adaptor for 1-2 modular devices like for instance miniature circuit breakers. With transparent grey cover. Material: ASA+PC, white or alu metallic.					
Modular device adaptor	Polar white	90/72/45	1	3606480681950	ISM10907P
Modular device adaptor	Alu metallic	90/72/45	1	3606480028540	ISM10957
<b>Front locking clip</b>					
Front locking clip to be mounted on either side of an outlet in order to secure pull-out forces. Material: PC/ABS.					
Front locking clip	Polar white	45/23/23	10	3606489604141	ISM10909P
<b>Label holder</b>					
Label holder for marking purposes. Package of ten. Material: PC/ABS.					
Label holder	White	23/23/45	10	3606489843021	ISM10920P
Label holder	Anthracite	23/23/45	10	3606489843038	ISM10921
Label holder	Alu metallic	23/23/45	10	3606489843045	ISM10922
Label holder	Red	23/23/45	10	3606490159319	ISM10923

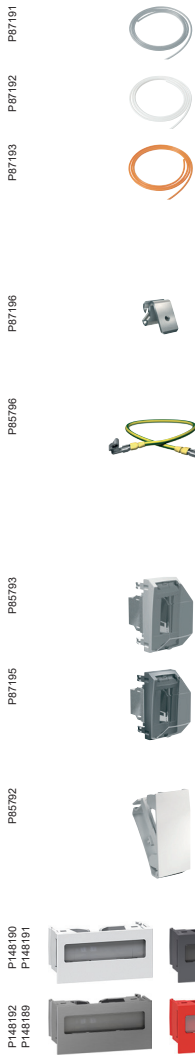

Comp.	Max. Ø mm	Cross section area mm <sup>2</sup>	Cable capacity (l) mm <sup>2</sup>			Diagram
			40%	50%	60%	
<b>One-sided pole</b>						
1	41	4220	1688	2110	2532	
<b>One-sided pole with partition profile</b>						
1	39	1799	720	900	1079	
2	15	1106	442	553	663	
<b>Two-sided pole without and with partition profile</b>						
1	41	3747	1499	1874	2248	
2	16	871	348	435	523	
3	39	1799	720	900	1079	
<b>Pole with four boxes</b>						
1	75	13966	5586	6983	8379	
<b>Pole profile for pole with four boxes</b>						
2	43	2535	1014	1267	1521	

(\*) We recommend a 40% utilization of the cable capacity.

# OptiLine 45 Poles

## Technical description

### Exploded views

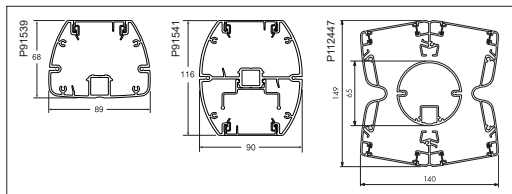
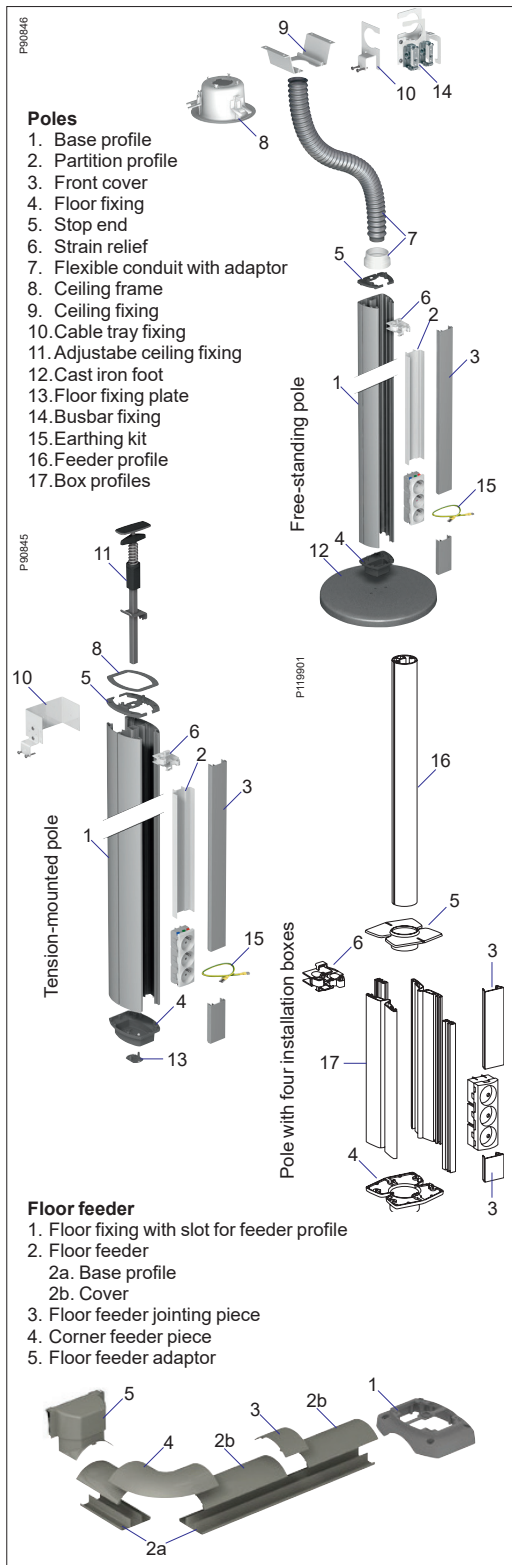

### Technical and Material data

Aluminium, extruded	Specification	EN-AW-6063
	Surface treatment	Natural anodizing or powder coating
	Colour	Polar white (RAL 9003)
Aluminium, die cast	Surface treatment	Powder coating
	Colour	Grey (RAL 9007)
Cast iron	Surface treatment	Coated with clear varnish
Zinc	Surface treatment	Untreated
PC/ABS	Fire rating	UL 94 HB
	Colour	White
PS (Polystyrene)	Colour	Polar white (RAL 9003)
	Other info	Halogen-free
PVC	Colour	Grey (RAL 7030)
PC+ASA	Fire rating	UL 94 HB
	Colour	Polar white (RAL 9003)
Steel	Specification	SS 1142
	Surface treatment	Powder coating
Silicone rubber	Colour	<ul style="list-style-type: none"> <li>• Grey</li> <li>• Orange</li> <li>• Polar white</li> </ul>

### Design and dimensions

		Tension-mounted poles	
		A Total height	B Height without ceiling fixing
P112455 Tension-mounted poles, one-sided and two-sided		Min. 2700 mm	2540 mm
		Max. 3100 mm	
		Min. 3100 mm	2940 mm
		Max. 3500 mm	
		Min. 3500 mm	3340 mm
P112456 Tension-mounted poles with four installation boxes		Max. 3900 mm	
		Min. 3900 mm	3740 mm
		Max. 4300 mm	
		Min. 4300 mm	
		Tension-mounted poles with boxes	
P112449 Free-standing poles, one-sided and two-sided		Min. 2700 mm	2510 mm
		Max. 3100 mm	
		Min. 3100 mm	2910 mm
		Max. 3500 mm	
P112450 Free-standing poles with one, two and four boxes		Max. 3900 mm	3310 mm
		Min. 3900 mm	
		Max. 4300 mm	
		Free-standing poles	
		A Total height of pole	B Length of flex. conduit
P112449 Free-standing poles, one-sided and two-sided		2150 mm	2000 mm
		2450 mm	2000 mm
		2900 mm	2000 mm
		Free-standing poles with boxes	
P112449 Free-standing poles, one-sided and two-sided		2150 mm	2000 mm
		2450 mm	2000 mm
		2900 mm	2000 mm



# OptiLine 45 Posts Presentation



## Service posts with 45 mm front opening for direct click-in of Unica wiring devices

OptiLine 45 service posts with a 45 mm front opening give a neat installation solution on all types of floors.

The posts have a softly rounded and compact form and are made of aluminium with a high surface finish, either natural anodised or powder coated white. They are available in one and two-sided versions.

On raised access floors and in-cavity floors the posts are fed from under the floor. On concrete floors the feeding comes from a screeded floor box. For other floors a floor feeder is available as an accessory.



### Unica 45x45 module wiring devices

The OptiLine 45 range has a front opening for direct click-in of Unica 45x45 module wiring devices which gives optimal function and design.

Unica offers a broad range of socket outlets, switches, VDI outlets and electronic products such as dimmers, movement detectors, thermostats, timers.

### One-sided posts

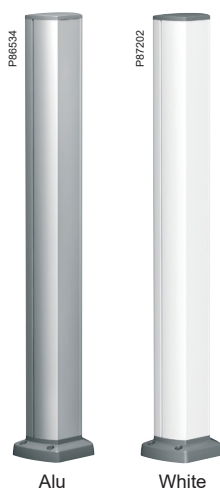

Alu White

### Two-sided posts

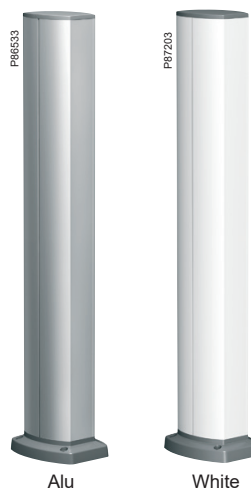

Alu White

### Two-sided posts for floor grommet

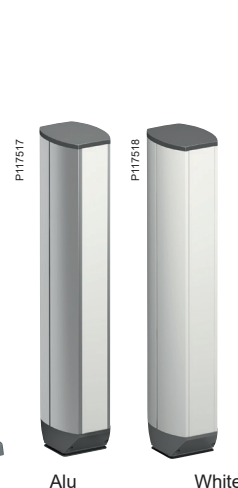

Alu White

# OptiLine 45 Posts Presentation

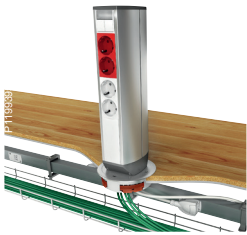

### Full flexibility

For a truly flexible solution, go for our two-sided outlet post with a special fixing for the floor grommet. Canalis busbar trunking and mesh trays distribute power and networks under the floor and further up to the post through the floor grommet. The floor grommet suits any type of floor and can be installed where required. Should needs be changed, just remove the post, put the cover back, install a new grommet and move the post to where it is needed.

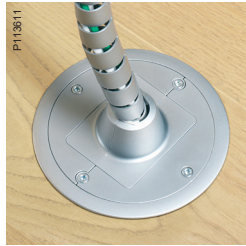

### Tube adaptor

With a tube adaptor in the floor grommet you can supply power and data to a furniture box instead.



### Stable and tight

When not in use the centre cover makes the floor grommet tight, withstanding both water and high loads.



### Design, finish and quality

All OptiLine posts are made of aluminium, anodized or powder coated, with a high surface finish. The form is softly rounded and slender. All parts are designed to give reliable function and easy installation.

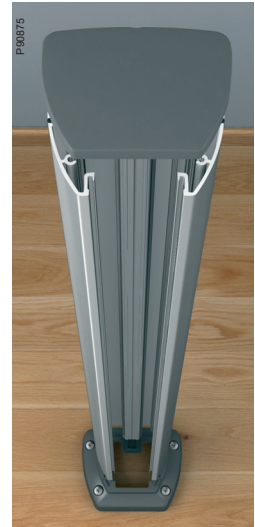

### Stable and sturdy

All parts in aluminium, several are die-cast.

- Stable and sturdy design
- Reliable function
- High-quality impression



### Feeding along/under the floor

Posts could be fed from the floor or along the floor

- Floor fixing for feeding from the floor as a standard
- Floor fixing with slot for floor feeder as an accessory



### Feeding from trunking

The post can be fed from a wall trunking.

- Easy and fast installation
- Floor feeder adaptor with adjustable height

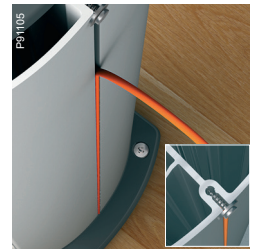

### Screw slots

Slots along both sides of the post

- For decorative colour strips
- For products like hooks etc.

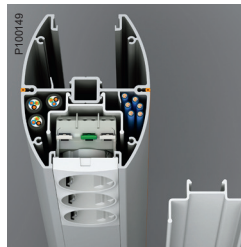

### Cable separation

Partition profile for good separation of cables.

- Correct distance between VDI and power cables
- Full isolation between wiring device terminations and cables

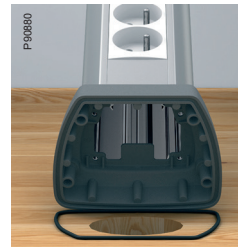

### Wet sealing

The floor fixing can be provided with a gasket ring.

- Gasket ring included in the package
- Effective wet sealing
- Stable mounting also on slightly uneven floors

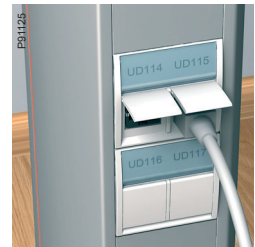











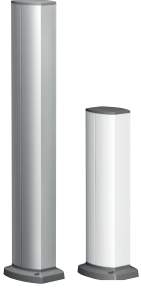

### Correct user interface

Unica 45x45 modules are designed also for vertical mounting

- Correct user interface
- Correct load on VDI patch cords

# OptiLine 45 Posts

## Choice guide

Posts					
	One-sided	Two-sided	Colour	Height mm	Ref. No.
<b>With floor fixing</b> 			Anodized aluminium Polar white	430 430	ISM20210 ISM20211P
			Anodized aluminium Polar white	700 700	ISM20200 ISM20201P
			Anodized aluminium Polar white	430 430	ISM20212 ISM20213P
			Anodized aluminium Polar white	700 700	ISM20202 ISM20203P
<b>With floor fixing for floor grommet</b> 			Anodized aluminium Polar white	430 430	ISM20220 ISM20221P
<b>With slotted floor fixing</b> 			Anodized aluminium Polar white	430 430	ISM20215 ISM20216P
			Anodized aluminium Polar white	700 700	ISM20205 ISM20206P
			Anodized aluminium Polar white	430 430	ISM20217 ISM20218P
			Anodized aluminium Polar white	700 700	ISM20207 ISM20208P

# OptiLine 45 Posts Range

## Posts

	Type	Colour	Dimensions A/B/C (mm)		Qty per package	EAN code	Ref. No.
<b>Post with floor fixing</b>							
Empty, free-standing, one or two-sided post mounted on a floor fixing. Including front cover, floor fixing, stop end, strain relief, partition profile, earthing kit and mounting instruction. Floor fixing provided with gasket ring. Unearthed. Supplied without service content and cables. 45 mm front opening for direct click-in of Unica 45x45 module wiring devices. Material: Aluminum, natural anodized or pow							
P100853 P86534	One-sided For up to six 45x45 module wiring devices	Anodized Polar white	430/68/89		1	3606480025532 3606480682322	ISM20210 ISM20211P
	One-sided For up to twelve 45x45 module wiring devices	Anodized Polar white	700/68/89		1	3606480029769 3606480682285	ISM20200 ISM20201P
P100887 P97203	Two-sided For up to six 45x45 module wiring devices on each side	Anodized Polar white	430/116/90		1	3606480025556 3606480682339	ISM20212 ISM20213P
	Two-sided For up to twelve 45x45 module wiring devices on each side	Anodized Polar white	700/116/90		1	3606480029783 3606480682292	ISM20202 ISM20203P
P117517 P117518	Empty, free-standing, two-sided post mounted on a floor fixing for floor grommet, intended for up to six 45x45 module wiring devices. Including plastic front covers, floor fixing, stop end, strain relief, partition profile, earthing kit and mounting instruction. Unearthed. Supplied without service content and cables. 45 mm front opening for direct click-in of Unica 45x45 module wiring devices. Material: Aluminum, natural anodized or powder coated white.						
	Two-sided for floor grommet	Anodized Polar white	430/116/90		1	3606480317460 3606480682360	ISM20220 ISM20221P
<b>Post with slotted floor fixing</b>							
Empty, free-standing, one or two-sided post mounted on a floor fixing. Including front cover, floor fixing with slot 18x75 mm, stop end, strain relief, partition profile, earthing kit and mounting instruction. Floor fixing provided with gasket ring. Unearthed. Supplied without service content and cables. 45 mm front opening for direct click-in of Unica 45x45 module wiring devices. Material: Aluminum, natural anodized or powder coated white.							
P104015 P103999	One-sided For up to six 45x45 module wiring devices	Anodized Polar white	430/68/89		1	3606480027512 3606480682346	ISM20215 ISM20216P
	One-sided For up to twelve 45x45 module wiring devices	Anodized Polar white	700/68/89		1	3606480027499 3606480682308	ISM20205 ISM20206P
	Two-sided For up to six 45x45 module wiring devices on each side	Anodized Polar white	430/116/90		1	3606480027529 3606480682353	ISM20217 ISM20218P
P104044 P104043	Two-sided For up to twelve 45x45 module wiring devices on each side	Anodized Polar white	700/116/90		1	3606480027505 3606480682315	ISM20207 ISM20208P



# OptiLine 45 Posts Range

## Pre-wired Posts

Type	Colour	Material	Dimensions A/B/C (mm)	Qty per package	Ref. No.
<b>One-sided Post</b>					
One-sided Post mounted on a floor fixing. Pre-wired, configured with 3 x double socket outlets, side-earthed, with cable, and 2 x Cat 6 UTP with cable. Including stop end and mounting instruction. Floor fixing provided with gasket ring. Earthed. External cables: one unshielded 3 x 1.5 mm <sup>2</sup> cable with side-earthed plug, 2.5 m free length, and two Cat 6 UTP data cables with RJ45 plugs, 9.0 m free length.					
One-sided Post	White	Aluminum	600/68/89	1	ISM22200
2 x Cat 6 UTP	Anodized	Aluminum	600/68/89	1	ISM22201
One-sided Post mounted on a floor fixing. Pre-wired, configured with 3 x double socket outlets, side-earthed, with cable, and 2 x Cat 6A S/FTP with cable. Including stop end and mounting instruction. Floor fixing provided with gasket ring. Earthed. External cables: one unshielded 3 x 1.5 mm <sup>2</sup> cable with side-earthed plug, 2.5 m free length, and two Cat 6A S/FTP data cables with RJ45 plugs, 9.0 m free length.					
One-sided Post	White	Aluminum	600/68/89	1	ISM22202
2 x Cat 6A S/FTP	Anodized	Aluminum	600/68/89	1	ISM22203



P111188  
P111189

## Accessories for posts

Type	Colour	Dimensions A/B/C (mm)	Qty per package	EAN code	Ref. No.
<b>Floor fixing with slot for floor feeder</b>					
Floor fixing for one or two-sided sided post. Fixed to the floor by screws. With slot for connection of floor feeder 18x75 mm. Material: Aluminium, powder coated.					
For one-sided post	Grey	38/125/102	1	3606480030703	ISM20820
For two-sided post	Grey	38/125/156	1	3606480030710	ISM20821
<b>Floor feeder, PVC</b>					
Floor feeder made up by a base part with three compartments and a cover. Supplied in lengths of 2 m. To be used for feeding along the floor to a post provided with a slotted floor fixing for 18x75 mm floor feeder. Material: PVC.					
Floor feeder	Grey	18/75/2000	28 m	3606480030673	ISM20817
<b>Floor feeder, aluminium</b>					
Floor feeder made up by a base part with three compartments and a cover. Supplied in lengths of 2 m. To be used for feeding along the floor to a post provided with a slotted floor fixing for 18x75 mm floor feeder. Material: Aluminium, natural anodized.					
Floor feeder	Anodized	18/75/2000	8 m	3606480027536	ISM20857
<b>Floor feeder jointing piece</b>					
Floor feeder jointing piece to cover joints between floor feeder sections. Material: PVC.					
Jointing piece	Grey	20/50/78	10	3606480030680	ISM20818
<b>Corner feeder piece</b>					
Corner feeder piece to be used in 90 degree corners between floor feeder sections. Material: PVC.					
Corner feeder piece	Grey	20/120/120	10	3606480030697	ISM20819
<b>Floor feeder adaptor</b>					
Adaptor to be used between floor feeder and wall trunking with a 45 mm front opening. Material: PC/ABS.					
Adaptor	Polar white	60/63/110	1	3606480682278	ISM20826P
Adaptor	Alu metallic	60/63/110	1	3606480030772	ISM20827
<b>Floor grommet</b>					
Grommet for floor applications, intended to suit a special version of the two-sided post. Including trim frame with fixing devices, two-part cover and sealing foam for protection from dust and wet floor-cleaning. The cover has the function of a water-tight blank plate when no post has been installed. When installing a post, the removed part of the cover remains in the grommet, secured by a strap. Hole diameter 127 mm. Material: Zinc, chromium plated.					
Floor grommet	—	38/Ø147	1	3606480160769	INS40550

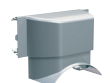



# OptiLine 45 Posts Range

## Accessories for posts

Type	Colour	Dimensions A/B/C (mm)		Qty per package	EAN code	Ref. No.
<b>Partition profile</b>						
Partition profile of halogen-free material with two partition walls. Mounted in internal fixing rails of poles and posts. Supplied in lengths of 0.5 m. Material: ABS.						
Partition profile	White	500/30/52		10	3606480030758	ISM20825
<b>Front cover</b>						
Front cover to be snap-fitted in service carriers with a 45 mm front opening. With earthing slots. Supplied with protective foil, in lengths of 2 m. Material: Aluminium, natural anodized or powder coated white.						
Front cover	Anodized	45/16/2000		24 m	3606480028489	ISM10950
Front cover	Polar white	45/16/2000		24 m	3606480682179	ISM10960P
<b>Decorative stripe</b>						
Decorative stripe to be fitted in the slots along the sides of poles and posts. Supplied in lengths of 5 m. Material: Silicone rubber.						
Decorative stripe	Grey	5000/Ø3.5		5 m	3606480030727	ISM20822
Decorative stripe	Polar white	5000/Ø3.5		5 m	3606480682261	ISM20823P
Decorative stripe	Orange	5000/Ø3.5		5 m	3606480030741	ISM20824
<b>Earthing clamp</b>						
Earthing clamp to be used for bonding of front cover, base profile and accessories to earth. Material: Steel.						
Earthing clamp	—	9/9/9		20	3606480028502	ISM10952
<b>Earthing kit</b>						
Kit including earth wire with flat pin connectors and earthing clamps. To be used to connect the front cover to the base profile.						
Earthing kit	Yellow/green	L = 200 L = 300		10 10	3606480028519 3606480038526	ISM10953 ISM10954
<b>Modular device adaptor</b>						
2-module adaptor for 1-2 modular devices like for instance miniature circuit breakers. With transparent grey cover. Material: ASA+PC.						
Modular device adaptor	Polar white	90/72/45		1	3606480681950	ISM10907P
Modular device adaptor	Alu metallic	90/72/45		1	3606480028540	ISM10957
<b>Front locking clip</b>						
Front locking clip to be mounted on either side of an outlet in order to secure pull-out forces. Material: PC/ABS.						
Front locking clip	Polar white	45/23/23		10	3606489604141	ISM10909P
<b>Label holder</b>						
Label holder for marking purposes. Package of ten. Material: PC/ABS.						
Label holder	White	23/23/45		10	3606489843021	ISM10920P
Label holder	Anthracite	23/23/45		10	3606489843038	ISM10921
Label holder	Alu metallic	23/23/45		10	3606489843045	ISM10922
Label holder	Red	23/23/45		10	3606490159319	ISM10923

# OptiLine 45 Posts

## Technical description



### Technical and Material data

Aluminium, extruded	Specification	EN-AW-6063
	Surface treatment	Natural anodizing or powder coating
	Colour	Polar white (RAL 9003)
Aluminium, die cast	Surface treatment	Powder coating
	Colour	Grey (RAL 9007)
PVC	Colour	Grey (RAL 7030)
PC/ABS	Fire rating	UL 94 HB
	Colour	<ul style="list-style-type: none"> <li>• Polar white (RAL 9003)</li> <li>• Aluminium metallic (painted)</li> </ul>
PC+ASA	Fire rating	UL 94 HB
	Colour	<ul style="list-style-type: none"> <li>• Polar white (RAL 9003)</li> <li>• Aluminium metallic</li> </ul>
Steel	Specification	SS 1142
Silicone rubber	Colour	<ul style="list-style-type: none"> <li>• Grey</li> <li>• Orange</li> <li>• Polar white</li> </ul>
	Degree of protection	IP30
	Temperature range	Operating temperature from -25°C to +60°C
Standards and certificates	The products comply with the standards:	
	<ul style="list-style-type: none"> <li>• EN 50085-1 : 2005</li> <li>• NFC 68 102 (French national standard)</li> </ul>	
	The products satisfy the provisions for CE marking according to the Low Voltage Directive 73/23/EEC and 93/68/EEC.	

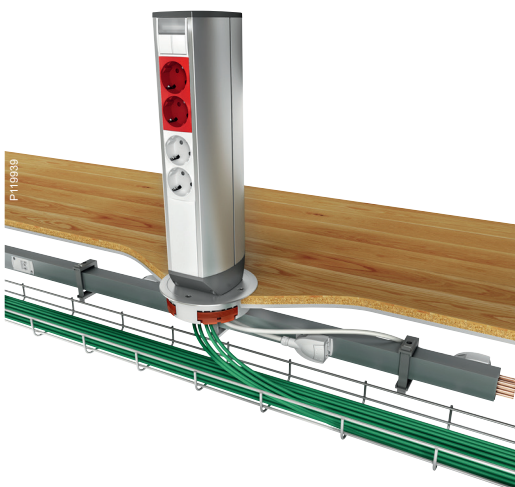

# OptiLine 45 Posts

## Technical description

### Exploded view

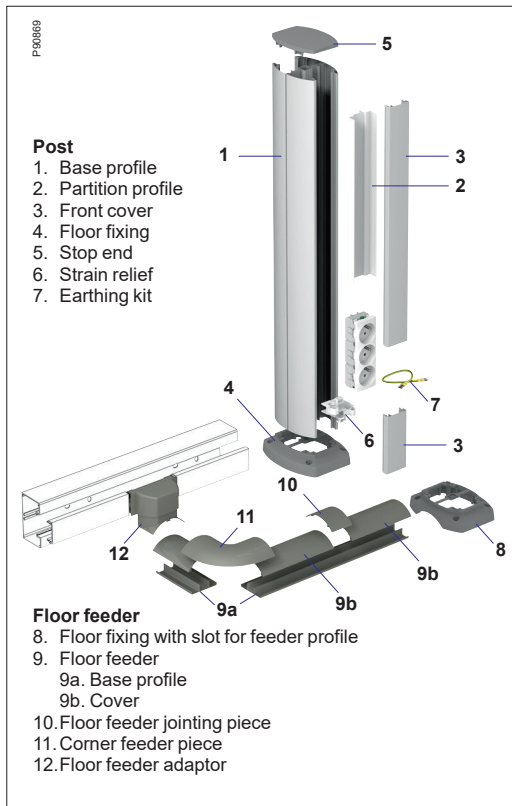

### Cable capacity

Comp.	Max Ø mm	Cross section area mm <sup>2</sup>	Cable capacity*) mm <sup>2</sup>			
			40%	50%	60%	
<b>One-sided post</b>						
1	41	4220	1688	2110	2532	P86032
<b>One-sided post with partition profile</b>						
1	39	1799	720	900	1079	P86031
2	15	1106	442	553	663	
<b>Two-sided post without and with partition profile</b>						
1	41	3747	1499	1874	2248	P86033
2	16	871	348	435	523	
3	39	1799	720	900	1079	

\*) We recommend a 40% utilization of the cable capacity.

### Design and dimensions

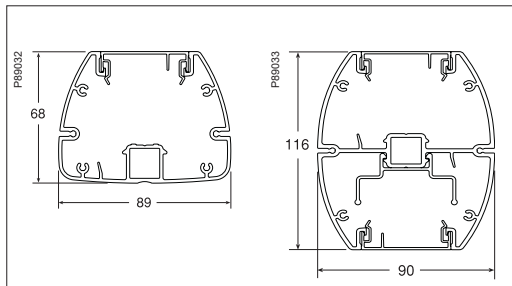

# OptiLine 45 Service boxes Presentation



## Service boxes with 45 mm front opening for direct click-in of Unica wiring devices

OptiLine 45 service boxes provide flexible solutions for the supply of power, telecom and data to desks in offices and conference rooms. The basic boxes can also be used as access points in the ceiling for feeding of poles.

Three box types are included in the offer:

- A six-sided pop-up box, pre-wired with outlets, cable and plug.
- A mini pop-up box, empty for three modules, with strain relief.
- A flip-up box, empty for five modules. For flush-mounting in desks. Fixing elements, earthing cable and strain relief included.
- A turnable and smoothly rounded one-sided box. Pre-wired with outlets, cables and plugs.
- A one-sided basic box.

All boxes are made in natural anodised aluminium with a high finish. Many boxes are delivered pre-wired for easy ordering and quick installation.

The pop-up box and the turnable boxes offer unique user advantages in terms of design and accessibility.



Pop-up service box



Mini pop-up service boxes



Flip-up service boxes



## Unica 45x45 module wiring devices

The OptiLine 45 range has a front opening for direct click-in of Unica 45x45 module wiring devices which gives optimal function and design.

Unica offers a broad range of socket outlets, switches, VDI outlets and electronic products such as dimmers, movement detectors, thermostats, timers.

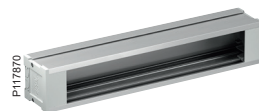

Basic service boxes





# OptiLine 45 Service boxes Presentation



## Flip-up and Pop-up



**Pop-up**  
Large-capacity box, 6-sided. A light touch activates a gas-operated spring that slowly pushes the box up into working position.



**Mini pop-up**  
A manual pop-up box with a smart membrane on top, enabling the box to be pushed down flush with the desk surface also with connected cables and plugs.



## Flip-up



**Flip-up**  
Flush-mounted box with a spring-loaded cover that is opened by a light touch. A cable basket is easily mounted under the box.



## Surface mounted

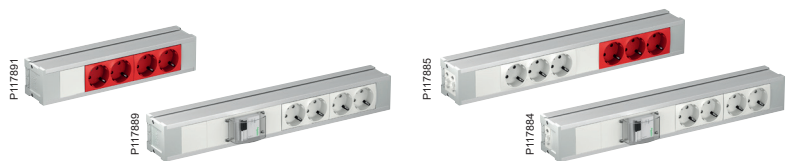



**Surface mounted boxes for every need**  
Universal boxes with smart fixing devices. Can be fixed to a desk, to a wall or to cable trays.

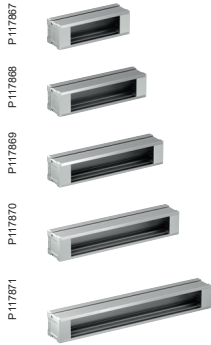

# OptiLine 45 Service boxes Range

## Basic desk units



Type	Colour	Dimensions A/B/C (mm)		Qty per package	EAN code	Ref. No.
<b>Basic desk unit, empty</b>						
One-sided desk unit, empty. Including base profile, stop ends, earthing cable and screws. Material: Aluminium, natural anodized.						
3 modules	Anodized	60/60/195		1	3606480273865	ISM20420
4 modules	Anodized	60/60/240		1	3606480273872	ISM20421
5 modules	Anodized	60/60/285		1	3606480273889	ISM20422
6 modules	Anodized	60/60/330		1	3606480273896	ISM20423
8 modules	Anodized	60/60/420		1	3606480273902	ISM20424

## Flush-mounted desk unit

Type	Colour	Dimensions A/B/C (mm)	Qty per package	EAN code	Ref. No.
<b>Desk unit with flip lid</b>					
Flush-mounted desk unit provided with a flip lid. Empty, intended for 12 modules (12x22.5 mm). To be mounted in a desk-top. Fixing elements, earthing cable, strain relief and mounting instruction included. Thickness of desk-top: 10-40 mm, hole dimensions: 142x295 mm. Material: Aluminium, steel, powder coated.					
Desk unit with flip lid	Grey	105/160/305	1	3606480317507	ISM20410
<b>Cable basket for desk unit with flip lid</b>					
Basket for cables, to be mounted under the frame of the flip-lid unit, for instance under a desk. Material: Steel, polyester/PVC cloth.					
Cable basket	White	170/150/265	1	3606480068461	INS40703

## Turnable desk unit

Type	Colour	Dimensions A/B/C (mm)	Qty per package	EAN code	Ref. No.
<b>Turnable desk unit, pre-defined/pre-wired</b>					
One-sided turnable desk unit. Standing on two feet, can be turned around its own axis to the desired position. Configured with 4 x double power outlets, Pin-earthed, with cable and various data outlets, see below. Earthed. Total lengths of power and data cables 6 m. Material: Aluminum, natural anodized.					
2 x Cat 6 UTP data outlets with cable	Anodized	92/130/618	1	3606481279989	ISM20350P

## Pop-up desk units, pre-wired

<b>Pop-up desk unit, pre-wired, with Unica side-earthed outlets</b>					
Pop-up desk unit, 6-sided. Three sides provided with double Unica socket outlets, side-earthed. Three sides are empty for future installation needs. Including 6 m of power connection cable with integrated plug. Fixing clamps and hooks for excess cables are included. When inactive, the pop-up unit is flush with the desk-top. By pushing the top down, the gas activated spring brings the unit to the accessible position. When not in use, the unit can easily be pushed back to the flush position. Material: Aluminum, anodized, with powder-coated top.					
Pre-wired with: 3 x double side-earthed socket outlets and 6 m power cable with plug	Anodized	325/Ø236	1	3606481279972	ISM20346P
<b>Pop-up desk unit, pre-wired, with Unica pin-earthed outlets</b>					
Pop-up desk unit, 6-sided. Three sides provided with double Unica socket outlets, pin-earthed. Three sides are empty for future installation needs. Including 6 m of power connection cable with integrated plug. Fixing clamps and hooks for excess cables are included. When inactive, the pop-up unit is flush with the desk-top. By pushing the top down, the gas activated spring brings the unit to the accessible position. When not in use, the unit can easily be pushed back to the flush position. Material: Aluminum, anodized, with powder-coated top.					
Pre-wired with: 3 x double pin-earthed socket outlets and 6 m power cable with plug	Anodized	325/Ø236	1	3606481279965	ISM20341P

## Manual pop-up desk units, empty

<b>Pop-up desk unit, empty</b>					
Pop-up desk unit, one-sided, manual. Including earthing cable, strain relief and mounting instruction. When inactive, the pop-up unit is flush with the desk-top. By a light pressure on the top, the unit can be lifted up from the desk surface. When not in use, it is easily pressed back to the flush position. Ordinary power and data plugs can remain in the outlets also in the flush position, since the cover is provided with a soft rubber membrane that allows the cables to exit in any direction (360°). Hole dimension: diam 100 mm. Material: Aluminium, anodized.					
Manual pop-up box, 6-module*	Anodized	252/112/-	1	3606480317484	ISM20400
Manual pop-up box, 8-module*	Anodized	297/112/-	1	3606480317491	ISM20401

\* 1 module = 22.5 mm

## Accessories for basic desk units

Type	Colour	Dimensions A/B/C (mm)		Qty per package	EAN code	Ref. No.
<b>Accessory kit</b>						
Accessory kit including mounting profiles, brackets and screws. For the installation of basic desk unit, snap-fitted and screw-locked, in OptiLine 70 front opening. Material: Aluminium, natural anodized.						
For 3 modules	Anodized	37/8/195		1	3606480273919	ISM20425
For 4 modules	Anodized	37/8/240		1	3606480273926	ISM20426
For 5 modules	Anodized	37/8/285		1	3606480273933	ISM20427
For 6 modules	Anodized	37/8/330		1	3606480273940	ISM20428
For 8 modules	Anodized	37/8/420		1	3606480273957	ISM20429
For 9 modules	Anodized	37/8/465		1	3606480334733	ISM20451
<b>Connection block</b>						
Connection block with strain relief, screw and one-module front cover. Material: PC, aluminium.						
Connection block	—	30/40/75		1	3606480274169	ISM20450
<b>Power cables</b>						
Extension cable 1-phase 250/400V 16A with connectors. Cable: halogen-free Ø10.2 mm, S05Z1A7Z1-F3G1.5 3x1.5mm <sup>2</sup> . Connectors: female GST 18i3 and male power connector (combined pin- and side-earth). NOTE: Only to be used for Schneider furniture units! Material: PA, PE/PP, FR.						
Cable, 3 m	White	Length 3000		1	3606480068485	INS40721
Cable, 5 m	White	Length 5000		1	3606480068492	INS40722
<b>Fixings for Basic box</b>						
Wall fixing, to be screw-fitted to the wall. The box is pushed in place on the fixing, can be mounted in three different positions. Also suitable for connection of two boxes. Material: Steel, zinc plated.						
Wall fixing	—	5/30/195		1	3606480068430	INS40700

P117892



P117893



P117894



P117895



P117896



P121475



P117897



P112435





P113020











# OptiLine 45 Service boxes Range

## Accessories for desk units

Type	Colour	Dimensions A/B/C (mm)		Qty per package	EAN code	Ref. No.
<b>Ceiling cable feeder</b>						
Cable feeder including base profile with separation wall and cover. Diameter 52 mm. For cable feeding from ceiling to work-desk. Material: Aluminium, natural anodized or powder coated white.						
Cable feeder	Anodized Polar white	3200/Ø52		1	3606480030505 3606480687112	ISM20800 ISM20801P
<b>Desk lead-through</b>						
Round guide bushing with flange and locking device. For lead-through of ceiling cable feeder through desktop. Material: Aluminium, powder coated grey or polar white.						
Desk lead-through	Grey Polar white	70/Ø80		1	3606480030529 3606480687129	ISM20802 ISM20803P
<b>Feeder adaptor</b>						
Adaptor for ceiling cable feeder. To be used as connection for flexible conduit Ø55 mm. Material: Aluminium, powder coated grey or polar white.						
Adaptor	Grey Polar white	25/Ø58.5		1	3606480030543 3606480687136	ISM20804 ISM20805P
<b>Foot adaptor</b>						
Adaptor intended for mounting the ceiling cable feeder onto a round foot (ISM20808). Material: Steel, painted.						
Foot adaptor	Grey	145/Ø60		1	3606480297960	ISM20832
<b>Round foot</b>						
Round foot to be fixed to foot adaptor to provide a stable base to the ceiling cable feeder. Fixes to the foot adaptor by means of two M6 bolts (included). Material: Cast iron, painted.						
Foot, round	Grey	29/Ø317		1	3606480030581	ISM20808
<b>Flexible conduit</b>						
Flexible conduit, Ø55 mm, to be used to bring cables from ceiling to cable feeder. Material: PUR (polyurethane).						
Flexible conduit	Alu metallic Polar white	2000/Ø55		2 m	3606480030567 3606480030574	ISM20806 ISM20807
Flexible conduit (split tube), Ø25 mm, to be used for cable feeding from ceiling to service carrier or from floor outlet box to desk top. Cables to be laid by using dedicated mounting tool. Material: PP.						
Flexible conduit	Grey metallic	Ø25/2000		2	3606480150340	ISM50850
<b>Mounting tool</b>						
Mounting tool for laying of cables in split-tube flexible conduits. Material: PP.						
For Ø25 mm conduit	—	Ø115/36/70		1	3606480150357	ISM50852
<b>Ceiling frame</b>						
Ceiling frame intended to lead flexible conduit through false ceiling. To be mounted in circular hole, Ø125 mm, by using three included clamps. Also including a slotted plastic plate to be used to lock the flexible conduit, which is fixed by cable ties. The plate can also be used as a drill template for entrance hole Ø125 mm. Material: PC/ABS.						
Ceiling frame	Polar white	89/Ø161		1	3606480682216	ISM20812P
<b>Cable tray fixing</b>						
Cable tray fixing including fixing material, intended to connect flexible conduit to cable tray. Gripping around cable tray. Material: Steel, powder coated.						
Cable tray fixing	White	100/15/70		1	3606480030635	ISM20813

### Accessories for desk units

Type	Colour	Dimensions A/B/C (mm)		Qty per package	EAN code	Ref. No.
<b>Ceiling fixing</b>						
Ceiling fixing intended to connect flexible conduit to ceiling or wall. Fixings not included. Material: Aluminium, powder coated.						
	White	50/156/90		1	3606480030666	ISM20816
<b>Busbar fixing</b>						
Busbar fixing for Ø55 mm conduits, intended to connect flexible conduit to busbar trunking. Material: Steel, powder coated.						
	White	105/90/70		1	3606480030659	ISM20815
<b>Floor grommet</b>						
Grommet for floor applications, intended to suit a special version of the two-sided service post. Including trim frame with fixing devices, two-part cover and sealing foam for protection from dust and wet floor-cleaning. The cover has the function of a water-tight blank plate when no service post has been installed. When installing a post, the removed part of the cover remains in the grommet, secured by a strap. Hole diameter 127 mm. Material: Zinc, chromium plated.						
	—	38/Ø147		1	3606480160769	INS40550
<b>Tube adaptor</b>						
Two-part tube adaptor for floor grommet. Intended for flexible tubes Ø25 mm. With integrated strain relief of flexible tube. To be used for instance together with flexible tube and a furniture unit. Material: Zinc, chromium plated.						
	—	39/64/80		1	3606480160752	INS40551
<b>Earthing kit</b>						
Kit including earth wire with flat pin connectors and earthing clamps. To be used to connect the front cover to the base profile.						
	Yellow/green	L = 200 L = 300		10 10	3606480028519 3606480028526	ISM10953 ISM10954
<b>Earthing clamp</b>						
Earthing clamp to be used for bonding of front cover, base profile and accessories to earth. Material: Steel.						
	—	9/9/9		20	3606480028502	ISM10952
<b>Modular device adaptor</b>						
2-module adaptor for 1-2 modular devices like for instance miniature circuit breakers. With transparent grey cover. Material: PC+ASA, white or alu metallic.						
	Polar white	90/72/45		1	3606480681950	ISM10907P
	Alu metallic	90/72/45		1	3606480028540	ISM10957



# OptiLine 45 Service boxes

## Technical description

### Exploded view

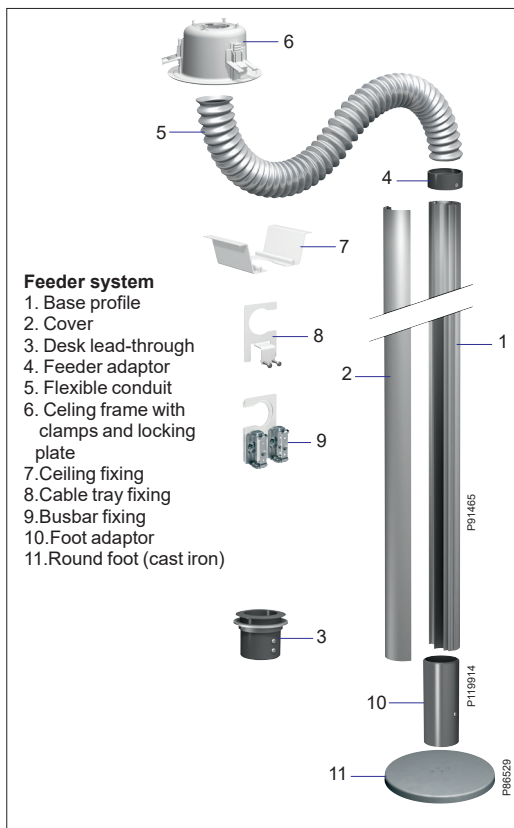

### Cable capacity

Comp.	Max Ø mm	Cross section area mm <sup>2</sup>	Cable capacity*) mm <sup>2</sup>			
			40%	50%	60%	
<b>Basic desk unit</b>						
1	48	2438	975	1219	1463	P121635
<b>Ceiling cable feeder</b>						
1	18	640	256	320	384	P183360
2	24	1046	418	523	628	

\*) We recommend a 40% utilization of the cable capacity.

### Dimensions

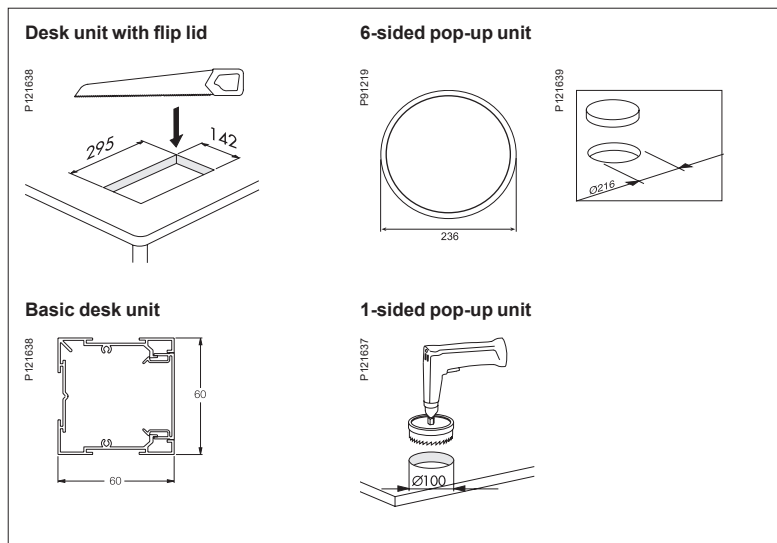

# OptiLine 45 Service boxes

## Technical description



### Description

OptiLine 45 desk units are made of natural anodized aluminium. Three types are included in the offer;

- A basic rectangular one-sided version made up by a base profile with accessories. To be mounted on desk, cable tray or wall by means of dedicated fixings. The unit can be installed in an OptiLine 70 post by incorporating an accessory kit. Supplied in an empty version in five sizes, to be used for customer configuration. Feeder accessories comfortably bring cables from the ceiling to the box.
- A flush-mounted desk unit provided with a flip lid. To be mounted in the desk-top, intended for single user application.
- A turnable one-sided desk unit, with smoothly rounded design. The box is standing on two designed feet and can be turned around its own axis to the desired position. Supplied in different configurations with cables and plugs.
- A one-sided manual pop-up desk unit, intended for single user applications, mounted in the desk-top (office application), or in kitchen table-tops (residential application).
- A round 6-sided pop-up desk unit, supplied in different configurations. The unit is intended for mounting in for instance conference tables, where there is a need for occasional connections to power and VDI.

### Benefits

- Made of natural anodized aluminium with a high finish.
- Many desk units are pre-wired for easy ordering and quick installation.
- Pop-up and turnable desk units offer unique user advantages in terms of design and accessibility.

### Technical and Material data

Aluminium; desk units	Specification	EN-AW-6063
	Surface treatment	Natural anodizing
Aluminium; accessories	Specification	EN-AW-6063
	Surface treatment	Natural anodizing or powder coating
	Colours	<ul style="list-style-type: none"> <li>• Polar white (RAL 9003)</li> <li>• Grey (RAL 9007)</li> </ul>
Steel	Specification	SS 1142
	Surface treatment	Powder coating
	Colour	Aluminium metallic
PUR (polyurethane)	Density	1.2 g/cm <sup>3</sup>
	Colour	<ul style="list-style-type: none"> <li>• Polar white (RAL 9003)</li> <li>• Aluminium metallic</li> </ul>
PC/ABS	Fire rating	UL 94 HB
	Colour	Polar white (RAL 9003)
PC+ASA	Fire rating	UL 94 HB
	Colour	<ul style="list-style-type: none"> <li>• Polar white (RAL 9003)</li> <li>• Aluminium metallic</li> </ul>

### Technical and Material data, cont.

Degree of protection	IP30
Temperature range	Operating temperature from -5°C to +60°C
Standards and certificates	<p>The products comply with the standards:</p> <ul style="list-style-type: none"> <li>• IEC 1084-1 (Basic desk unit only)</li> <li>• IEC 1084-2-4 (Basic desk unit only)</li> <li>• SS 424 10 32: 1989</li> </ul> <p>The products satisfy the provisions for CE marking according to the Low Voltage Directive 73/23/EEC and 93/68/EEC</p> <p>The products are approved for installation of the</p>
Unica	<p>range of service content</p> <p>All desk units are CE-marked</p>



# OptiLine 45

## Reference number overview

<b>100●●●●</b>					
1003003.....	21	ISM10304P.....	15	ISM20118.....	28
1003020.....	21	ISM10305P.....	15	ISM20119P.....	28
1005008.....	21	ISM10306P.....	15	ISM20120.....	28
1150002.....	21	ISM10308P.....	16	ISM20121P.....	28
1150051.....	21	ISM10310P.....	14	ISM20122.....	28
		ISM10350.....	18	ISM20123P.....	28
<b>120●●●●</b>		ISM10351.....	18	ISM20130.....	28
1200005.....	22	ISM10352.....	18	ISM20131P.....	28
1200401.....	22	ISM10353.....	18	ISM20132.....	28
1220104.....	22	ISM10354.....	19	ISM20133P.....	28
		ISM10355.....	19	ISM20140.....	28
<b>126●●●●</b>		ISM10356.....	19	ISM20141P.....	28
1260170.....	22	ISM10357.....	19	ISM20142.....	28
		ISM10358.....	19	ISM20143P.....	28
<b>177●●●●</b>		ISM10400P.....	14	ISM20144.....	28
1772052.....	22	ISM10401P.....	14	ISM20145P.....	28
1772054.....	22	ISM10402P.....	14	ISM20146.....	29
1772056.....	22	ISM10403P.....	15	ISM20147P.....	29
1772058.....	22	ISM10404P.....	15	ISM20148.....	29
		ISM10405P.....	15	ISM20149P.....	29
<b>378●●●●</b>		ISM10406P.....	15	ISM20150.....	29
3782020.....	21	ISM10450.....	18	ISM20151P.....	29
3782030.....	21	ISM10451.....	18	ISM20200.....	37, 38
3782420.....	21	ISM10452.....	18	ISM20201P.....	37, 38
3782430.....	21	ISM10453.....	18	ISM20202.....	37, 38
3782440.....	21	ISM10454.....	19	ISM20203P.....	37, 38
		ISM10455.....	19	ISM20205.....	37, 38
<b>402●●●●</b>		ISM10456.....	19	ISM20206P.....	37, 38
4020210.....	21	ISM10500P.....	14	ISM20207.....	37, 38
		ISM10501P.....	14	ISM20208P.....	37, 38
<b>IMT●●●●●</b>		ISM10502P.....	14	ISM20210.....	37, 38
IMT48002.....	21	ISM10503P.....	15	ISM20211P.....	37, 38
		ISM10504P.....	15	ISM20212.....	37, 38
<b>INS●●●●●</b>		ISM10505P.....	15	ISM20213P.....	37, 38
INS40480.....	31	ISM10506P.....	15	ISM20215.....	37, 38
INS40481.....	31	ISM10550.....	18	ISM20216P.....	37, 38
INS40482.....	31	ISM10551.....	18	ISM20217.....	37, 38
INS40483.....	31	ISM10552.....	18	ISM20218P.....	37, 38
INS40484.....	31	ISM10553.....	18	ISM20220.....	37, 38
INS40485.....	31	ISM10554.....	19	ISM20221P.....	37, 38
INS40486.....	31	ISM10555.....	19	ISM20341P.....	46
INS40550.....	39, 49	ISM10556.....	19	ISM20346P.....	46
INS40551.....	49	ISM10900P.....	16	ISM20350P.....	46
INS40700.....	47	ISM10901.....	16, 19	ISM20400.....	46
INS40703.....	46	ISM10902.....	16, 19	ISM20401.....	46
INS40721.....	47	ISM10903P.....	16	ISM20410.....	46
INS40722.....	47	ISM10904.....	16, 20	ISM20420.....	45
		ISM10905P.....	16, 20	ISM20421.....	45
<b>ISM●●●●●</b>		ISM10907P.....	17, 33, 40, 49	ISM20422.....	45
ISM10100P.....	14	ISM10908.....	17	ISM20423.....	45
ISM10101P.....	14	ISM10909P.....	17, 20, 33, 40	ISM20424.....	45
ISM10102P.....	14	ISM10920P.....	17, 20, 33, 40	ISM20425.....	47
ISM10103P.....	15	ISM10921.....	17, 20, 33, 40	ISM20426.....	47
ISM10104P.....	15	ISM10922.....	17, 20, 33, 40	ISM20427.....	47
ISM10105P.....	15	ISM10923.....	17, 20, 33, 40	ISM20428.....	47
ISM10106P.....	15	ISM10950.....	16, 19, 32, 40	ISM20429.....	47
ISM10107P.....	16	ISM10951.....	16, 20	ISM20450.....	47
ISM10110P.....	14	ISM10952.....	20, 33, 40, 49	ISM20451.....	47
ISM10150.....	18	ISM10953.....	20, 33, 40, 49	ISM20552P.....	30
ISM10151.....	18	ISM10954.....	20, 33, 40, 49	ISM20800.....	48
ISM10152.....	18	ISM10955.....	20	ISM20801P.....	48
ISM10153.....	18	ISM10957.....	20, 33, 40, 49	ISM20802.....	48
ISM10154.....	19	ISM10960P.....	32, 40	ISM20803P.....	48
ISM10155.....	19	ISM11254.....	19	ISM20804.....	48
ISM10156.....	19	ISM20100.....	28	ISM20805P.....	48
ISM10157.....	19	ISM20101P.....	28	ISM20806.....	48
ISM10200P.....	14	ISM20102.....	28	ISM20807.....	48
ISM10201P.....	14	ISM20103P.....	28	ISM20808.....	30, 48
ISM10202P.....	14	ISM20104.....	28	ISM20809.....	30
ISM10203P.....	15	ISM20105P.....	28	ISM20810P.....	30
ISM10204P.....	15	ISM20106.....	28	ISM20811P.....	30
ISM10205P.....	15	ISM20107P.....	28	ISM20812P.....	30, 48
ISM10206P.....	15	ISM20108.....	28	ISM20813.....	30, 48
ISM10207P.....	16	ISM20109P.....	28	ISM20814.....	30
ISM10208P.....	16	ISM20110.....	28	ISM20815.....	30, 49
ISM10250.....	18	ISM20111P.....	28	ISM20816.....	30, 49
ISM10251.....	18	ISM20112.....	28	ISM20817.....	32, 39
ISM10252.....	18	ISM20113P.....	28	ISM20818.....	32, 39
ISM10253.....	18	ISM20114.....	28	ISM20819.....	32, 39
ISM10255.....	19	ISM20115P.....	28	ISM20820.....	32, 39
ISM10256.....	19	ISM20116.....	28	ISM20821.....	32, 39
ISM10258.....	19	ISM20117P.....	28	ISM20822.....	33, 40
ISM10300P.....	14				
ISM10301P.....	14				
ISM10302P.....	14				
ISM10303P.....	15				

# OptiLine 45

## Notes

---

Life Is On



**Schneider Electric Industries SAS**

35, rue Joseph Monier  
CS 30323  
92506 Rueil Malmaison Cedex  
France

RCS Nanterre 954 503 439  
Capital social 896 313 776 €  
[www.schneider-electric.com](http://www.schneider-electric.com)

07-2022

© 2022 - Schneider Electric. All Rights Reserved.  
All trademarks are owned by Schneider Electric Industries SAS or its affiliated companies.  
ISC00942\_OptiLine 45

This document has been  
printed on recycled paper

