

Cepex wandcontactdoos

Bestelnr. 4219



- schroefklemmen
- andere varianten op aanvraag

Technische informatie

Ampère	16 A
Polen	3 p
Voltage	230 V
Uurstand	6 h
Hertz	50-60 Hz
Beschermingsgraad	IP 44
Aanrakingsveiligheid	false
Gewicht	506 g
Certificeringen	EAC, CQC

Tekeningen

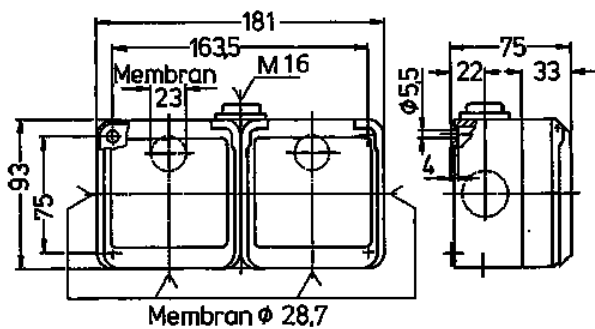

Tekening	Amp.	16		
		3	4	5
1 MB 350	Polen			
Maten in mm				
Kabelaansluiting		1,5	1,5	1,5
van/tot mm²		—4	—4	—4