















**TARA Zweiwege-Umstellung für Wannenrand- bzw. Fliesenrandmontage -  
Bronze gebürstet**

TARA

29 140 892 Produktversion ab 30.06.2015



- automatische Umstellung Wanne/Brause
- Bohrungsdurchmesser 32 mm
- Rosette Ø 55 mm
- Anschluss 1/2"
- Durchfluss max. 64,9 l/min bei 3 bar Fließdruck

	Bronze gebürstet	29 140 892-42
	Chrom	29 140 892-00
	Platin gebürstet	29 140 892-06
	Platin	29 140 892-08
	Weiß matt	29 140 892-10
	Dark Brass matt	29 140 892-16
	Dark Bronze matt	29 140 892-17
	Dark Chrome	29 140 892-19
	Light Gold gebürstet	29 140 892-27
	Messing gebürstet (23kt Gold)	29 140 892-28
	Schwarz matt	29 140 892-33
	Champagne gebürstet (22kt Gold)	29 140 892-46
	Champagne (22kt Gold)	29 140 892-47
	Chrom gebürstet	29 140 892-93
	Dark Platinum gebürstet	29 140 892-99

29 140 892 Produktversion ab 30.06.2015  
mm [inches]

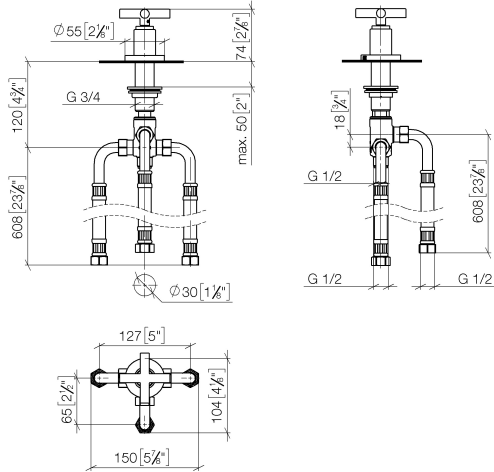

**Durchflussdiagramm**

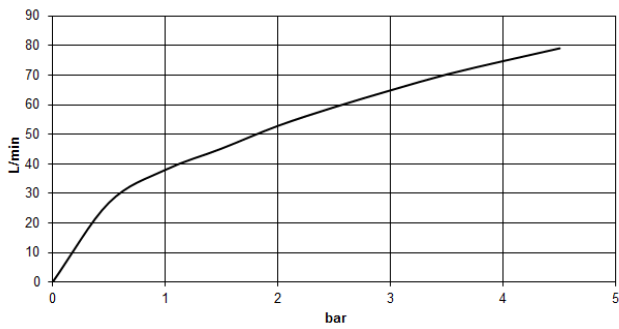

**Codes & Standards**

ASME A112.18.1      cUPC      DIN 4109      ISO 3822

**Ü-Zeichen**



TARA Zweiwege-Umstellung für Wannenrand- bzw. Fliesenrandmontage -  
Bronze gebürstet

---

TARA

29 140 892 Produktversion ab 30.06.2015

Zertifikate

---

LGA\_29

IAPMO\_4976

**TARA Zweibege-Umstellung für Wannenrand- bzw. Fliesenrandmontage -  
Bronze gebürstet**

TARA

29 140 892 Produktversion ab 30.06.2015

Ersatzteile für die  
anderen  
Oberflächenvarianten  
finden Sie hier:  
Chrom

