

Montageanleitung

CN 安装说明

CRO Upute za ugradnju

CZ Návod k instalaci

DK Montagevejledning

E Instrucciones de montaje

F Instructions de montage

GB Installation instructions

GR Οδηγία συναρμολόγησης

H Szerelési utasítás

I Istruzioni di montaggio

NL Montagehandleiding

NO Installasjonsanvisning

P Instrução de montagem

PL Instrukcja montażu

ROM Instrucțiuni de montare

RU Указания по установке

S Monteringsanvisning

SER Uputstvo za montažu

SF Asennusohje

SK Návod na montáž

SLO Navodila za montažo

TR Montaj talimatı

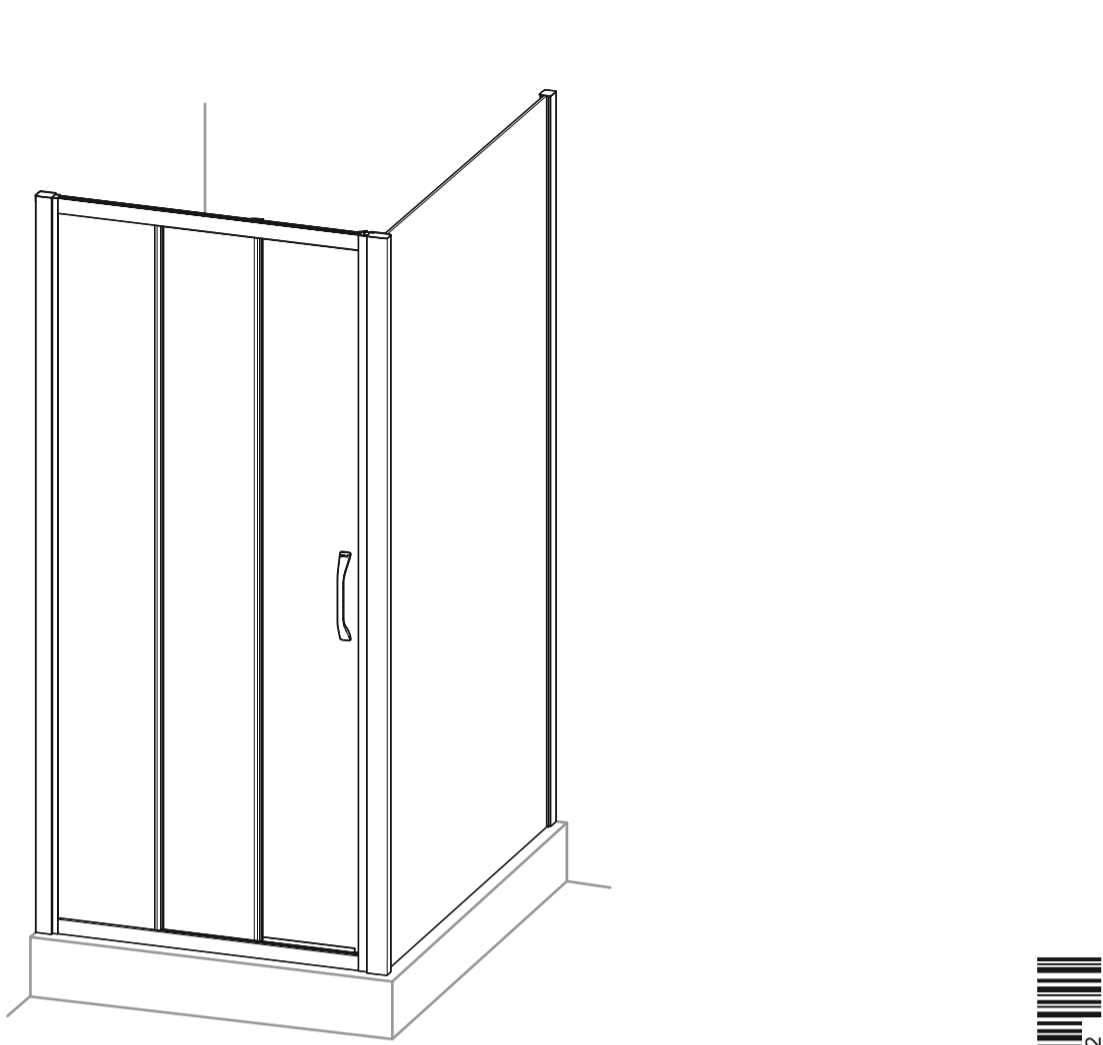

- D Wichtiger Hinweis:** Bitte prüfen Sie die Duschabtrennung vor dem Einbau auf Transportschäden und Vollständigkeit. Nach dem Einbau können Beanstandungen nicht mehr anerkannt werden. Bitte prüfen Sie auf dem Karton, ob das Maß WEM oder M ist.

- CN 重要提示:** 请在安装淋浴隔板之前检查是否存在运输损坏以及货物是否完整。安装之后才提交的投诉不予受理。请检查纸箱上的尺寸是WEM还是M。

- SK Važna napomena:** Provjerite potpunost pregrada za tuševе i mogućа oštećenja pri transportu prije ugradnje. Nakon ugradnje ne možemo više priznati reklamacije. Provjerite na kartonu je li veličina WEM ili M.

- CZ Důležité upozornění:** Před instalací sprchové kabiny přezkontrolujte, prosím, zda nebyla kabina během přepravy poškozena a zda je dodávka kompletní. Po zabudování nemůže být reklamacе již uznána. Zkontrolujte, jestli na krabici, jestli je rozměr WEM nebo M.

- NO Viktig oplysning:** Inden kabinevæggen monteres, undersøges den for transportskader o.lign., idet reklamationer ikke kan godkendes efter at montering har fundet sted. Se efter på papkassen, om målet er WEM eller M.

- E Nota importante:** Por favor, antes de montar la mampara se debe controlar que el producto no haya sufrido daños durante el transporte y que todas las piezas estén completas. Una vez instalado el artículo no asumiremos ninguna responsabilidad por las eventuales reclamaciones. Por favor compruebe en el cartón si se trata de la medida WEM o bien M.

- F Remarque importante:** avant de procéder au montage, vérifiez que le pare-douche est complet et qu'il n'a pas été endommagé lors du transport. Aucune réclamation ne pourra être admise après le montage. Vérifier si la mesure indiquée sur le carton est WEM ou M.

- GB Important information:** Please check the shower enclosure for transport damage and completeness before installation. Complaints made following installation cannot be accepted. Please check the information on the cardboard box whether the dimensions are WEM or M.

- GR Σημαντική υπόδειξη:** Παρακαλώ ελέγξτε το διαχωριστικό ντουζιέρας πριν από την τοποθέτηση για ζημιές μεταφοράς και πληρότητα. Μετά την τοποθέτηση δεν μπορεί πια να αναγνωριστούν παράπονα σχετικά με τα παραπάνω. Παρακαλώ ελέγξτε στη συσκευασία εάν η διάσταση είναι WEM ή M.

- H Fontos tudnivaló:** Kérjük, beépítés előtt ellenőrizze a zuhanylevélasztót, hogy a szállításnál nem sérült-e és hogy hiánytalan-e. A beépítés után már nem fogadunk el reklamációt. Kérjük ellenőrizze a kartonon, hogy a méret WEM, vagy M.

- I Avviso importante:** Prima di effettuare il montaggio vi preghiamo di controllare se la parete divisoria della doccia presenta dei danni di trasporto. Dopo il montaggio non vengono più accettati reclami. Controllare sul cartone se la misura corrisponde a WEM o M.

- NL Belangrijk:** Controleer voor het inbouwen of het douchescherm bij het transport beschadigd is en of het volledig is. Na het inbouwen kunnen klachten niet meer in behandeling genomen worden. Kijk op de deo's of de maat WEM of M is.

- NO Viktig informasjon:** Vennligst sjekk dusjkabinettet for transportskader og at det er komplett før installasjon. Klager som gjøres etter installasjon kan ikke aksepteres. Kontroller om målene på kartongen er WEM eller M.

- P Indicação importante:** Favor verificar antes da instalação se a separação de chuveiro está completa e se sofreu danos de transporte. Depois da montagem não se aceitam reclamações. Por favor, verifique se a medida indicada na embalagem é WEM ou M.

- PL Ważna wskazówka:** Przed zabudowaniem przysznycowej ścianki działowej należy sprawdzić jej kompletność i skontrolować na obecność ewentualnych uszkodzeń powstałych w czasie transportu. Po dokonaniu zabudowy reklamacje nie będą uwzględniane. Sprawdź na kartonie, czy wymiarem to WEM lub M.

- SK Instrukciune importantă:** Înainte de montare vă rugăm să inspectați cabina de duș cu privire la integritate și la eventualele deteriorări produse în urma transportului. După montare nu se mai admit reclamații. Vă rugăm să verificați mărimea înscrisă pe ambalaj, dacă este WEM sau M.

- TR Вaжнa инфopмация:** Перед сборкой проверьте душевую кабину на наличие повреждений и ее укомплектованность. Претензии после сборки не принимаются. Уточните на картонной коробке, какой это размер — WEM или M.

- S Viktig hänvisning:** Innan duschskiljeväggen byggs in måste man kontrollera att inga transportskador uppkommit på den och att den är fullständig. När den byggts in kan inte några reklamationer accepteras längre. Kontrollera på kartongen om måttet är WEM eller M.

- SF Važna napomena:** Molimo vas da proverite da li je tuš kabina oštećena u transportu i da li je potpuna. Reklamacije se po obavljenoj montaži više ne priznaju. Proverite da li se na kartonu nalazi oznaka WEM ili M.

- SE Tärkeä ohje:** Tarkista suihkuseinäke ennen asennusta kuljetusvauroiden varalta ja tarkista myös toimituksen sisältö. Asennuksen jälkeen ei valituksia enää voida ottaa huomioon. Tarkista laatikosta, onko mitta WEM tai M.

- SK Dôležité upozornenie:** Pred abudovaním oddeovacej sprchovacej steny skontrolujte prosím, i nebola pokodená poas prepravy a i je dodávka úplná. Po zabudovaní sa reklamácie u neuznávajú. Prosím skontrolujte na kartóne, či je to rozmer WEM alebo M.

- TR Važen nasvet:** Pred montažo preverite, e je bila kabina za prhanje na prevozu poškodovana in da je popolna. Reklamacije po konani montaži ne moremo ve upoštevati. Prosimo preverite na kartonu, ali gre za mero WEM ali M.

- TR Önemli açıklama:** Du duvarını takmadan önce lütfen nakliyat hasarı ve eksiksiz olup olmadığını kontrol ediniz. Du duvarını takdıktan sonra yapılacak ikayetler kabul edilmez. Lütfen kartonun üzerindeki ölçünün WEM mi, M mi olduğunu kontrol ediniz.

- D Sicherheitshinweis:** Die Installation ist durch einen Fachmann durchzuführen. Hütte Einscheibensicherheitsgläser dürfen nachträglich nicht bearbeitet werden. Stets die Kanten der Scheiben schützen, z. B. beim Abstellen der Scheiben immer Holz oder Pappe als Unterlage benutzen.

- CN 安全提示:** 安装工作应由一名专业人员进行。HÜPPE单层安全玻璃不可事后再进行处理。请始终保护玻璃边缘，比如在放下玻璃时始终使用木头或纸板垫底。

- SK Sigurnosna napomena:** Ugradnju treba obaviti stručnjak. Ne smijete naknadno obrađivati jednoslajna sigurnosna stakla Hüppe. Uvijek zaštitite rubove ploča, npr. pri spuštanju ploča uvijek upotrijebite drvo ili karton kao podlogu.

- CZ Bezpečnostní pokyny:** Instalaci smí provést pouze odborník. Jednoduché bezpečnostní okenní tabule firmy Hüppe nesmí být dodatečně opracovávány. Hrany tabulí musí být neustále chráněny; používejte např. při stavění tabulí na hrany vždy dřevěnou nebo lepenkovou podložku.

- NO Sikkerhetsoplysning:** A beszerelést szakemberrel végeztesse! A Hüppe-féle egy rétegű biztonsági üvegből készült ajtókat nem szabad utólag megmunkálni. Az üvegek széléit mindig védjék, pl. az üveg leállításánál mindig használjon alátétként fát vagy papírtelmezt.

- E Reglamento de seguridad:** Es imprescindible que se efectúe la instalación debidamente por parte de un técnico especializado. Una vez instalados los vidrios de seguridad de Hüppe no se deben someter a manipulación posterior. Hay que observar siempre la protección de los cantos de los vidrios, al apoyar los vidrios en el suelo depositarlos p. e. sobre madera o cartón.

- F Remarques concernant la sécurité:** l'installation doit être confiée à un professionnel. Vous ne devez en aucune façon tenter de retailer les vitrages Hüppe en verre sécurit. Veillez à en protéger les bords, par exemple en utilisant du bois ou du carton comme support avant de les poser par terre.

- GB Safety information** Installation must be carried out by trained personnel. Single-pane, safety glass panels from Hüppe must not be reworked in any way following supply. Always protect the edges of the panes, e.g. always set down on a strip of wood or card.

- GR Υπόδειξη ασφαλείας:** Η εγκατάσταση πρέπει να διενεργηθεί από ειδικό. Τα μονά τζαμία ασφαλείας της Hüppe δεν επιτρέπεται να επεξεργαστούν εκ των υστέρων. Να προστατεύετε πάντα τις ακμές των τζαμιών, π. χ. κατά την αποθήκευση τους να χρησιμοποιείτε πάντα ξύλο ή χαρτόνι ως υπόθεμα.

- H Biztonsági tudnivalók:** A beszerelést szakemberrel végeztesse! A Hüppe-féle egy rétegű biztonsági üvegből készült ajtókat nem szabad utólag megmunkálni. Az üvegek széléit mindig mindig védjék, pl. az üveg leállításánál mindig használjon alátétként fát vagy papírtelmezt.

- I Cenno sulla sicurezza:** Il montaggio deve venire effettuato da un tecnico specializzato. Non è lecito eseguire lavorazioni successive sui vetri di sicurezza Hüppe a lastra singola. Proteggete sempre gli orli delle lastre, p. es. impiegate sempre del legno o della carta come appoggio per le lastre che vengono messe da parte.

- NL Veiligheidsvoorschrift:** De installatie moet door een vakman worden uitgevoerd. Hüppe gehard veiligheidsglas mag niet achteraf worden bewerkt. Bescherm altijd de zijkanten van de ruit; gebruik bv. bij het plaatsen van de ruit altijd hout of karton als ondergrond.

- NO Sikkerhetsinformasjon:** Installasjon må gjøres av opplært personell. Helpealte sikkerhetsglass paneler fra Hüppe må ikke endres på noen måte etter levering. Beskytt alltid kantene av glasset, sett det f.eks. ned på et stykke tre eller papp.

- P Indicação de segurança:** A instalação deve ser feita por um especialista. Os vidros de segurança de Hüppe não devem ser trabalhados ulteriormente. Proteger sempre os cantos dos vidros utilizando p.expl. madeira ou cartão como base para depositar o vidro.

- PL Wskazówki bezpieczeřstwa:** Instalacje należą powierzyć fachowcowi. Jednowarstwowych szyb bezpiecznych firmy Hüppe nie należą poddawać dalszej obróbce. Przy odstawianiu szyb konieczne krawędzie, np. przez ustawienie na drewnianej lub tekturowej podkładce.

- SK Instrukciune de siguranță:** Instalarea trebuie efectuată de un specialist. Nu este permisă o prelucrare ulterioară a panourilor din geam securizat Hüppe. Protejați întotdeauna muchiile geamurilor, de exemplu: la depunerea geamurilor pe podea utilizați întotdeauna suporturi din lemn sau carton.

- TR İnformация по безопасности:** Сборку должен производить подготовленный персонал. После поставки одиночные панели и панели из безопасного стекла фирмы Hüppe нельзя каким-либо образом переделывать. Обеспечивайте постоянную защиту кромок панелей, напр., всегда устанавливайте их на брус или картон.

- S Säkerhetsupplysning:** Installationen ska genomföras av en fackman. Hüppe säkerhetsglas med ett glas får inte bearbetas ytterligare efteråt. Man måste alltid se till att skydda glassens kanter, t ex alltid använda trä eller papp som underlag när man ställer ifrån sig glasen.

- SF Mere opreza:** Instaliranje treba da obavi stručnjak. Jednostrana sigurnosna stakla Hüppe ne smeju se naknadno obrađivati. Uvek štitive iverce stakala, na primer prilikom odlaganja uvek postavite komad drveta ili kartona kao podlogu.

- SE Turvallsuusohje:** Asennus on suoritettava ammattihenkilön toimesta. Yksilasilaisia Hüppe-varmuuslaseja ei saa käsitellä jälkikäteen. Suojaa aina lasien reunat; esim. maahan laskettaessa käytä aina puu- tai pahvialustaa.

- SK Bezpečnostné pokyny:** Montáž musí previes odborník. Bezpenostné jednovrstvové sklá Hüppe sa dodatone nesmú opracováva. Hrany tabú musia by stále chránené, napr. pre odstavenie tabú používajte zakadým drevenú alebo lepenkovú podloku.

- TR Vamostni nasveti:** Montažo mora opraviti strokovnjak. Vamostne enostenske šipe proizvajalca Hüppe ne smete naknadno obdelovati. Vedno morate zaštititi robove in šipe, npr. e odstavite šipe vzemite vedno les ali karton za podlogo.

- TR Emniyet açıklaması:** Du duvarının bir usta tarafından takılması gereklidir. Hüppe'nin emniyet camından mamül tek katlı levhalarının sonradan ileilmesi yasaktır. Camın kenarlarını, örnein camı yere koyarken altına tahta veya karton koyarak daima koruyunuz.



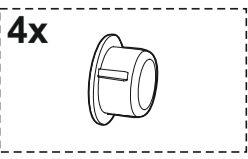
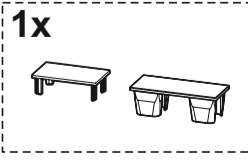
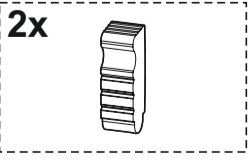
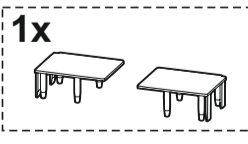
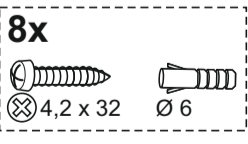
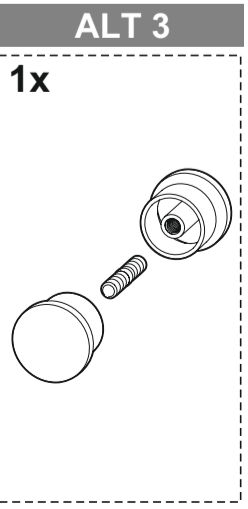
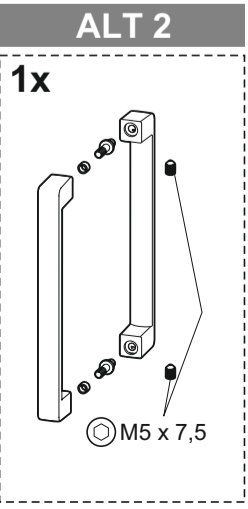
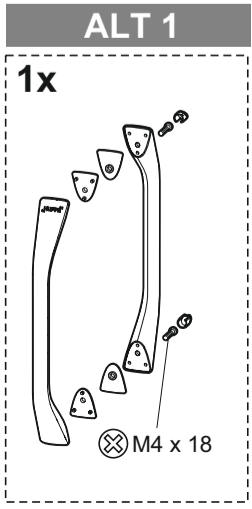
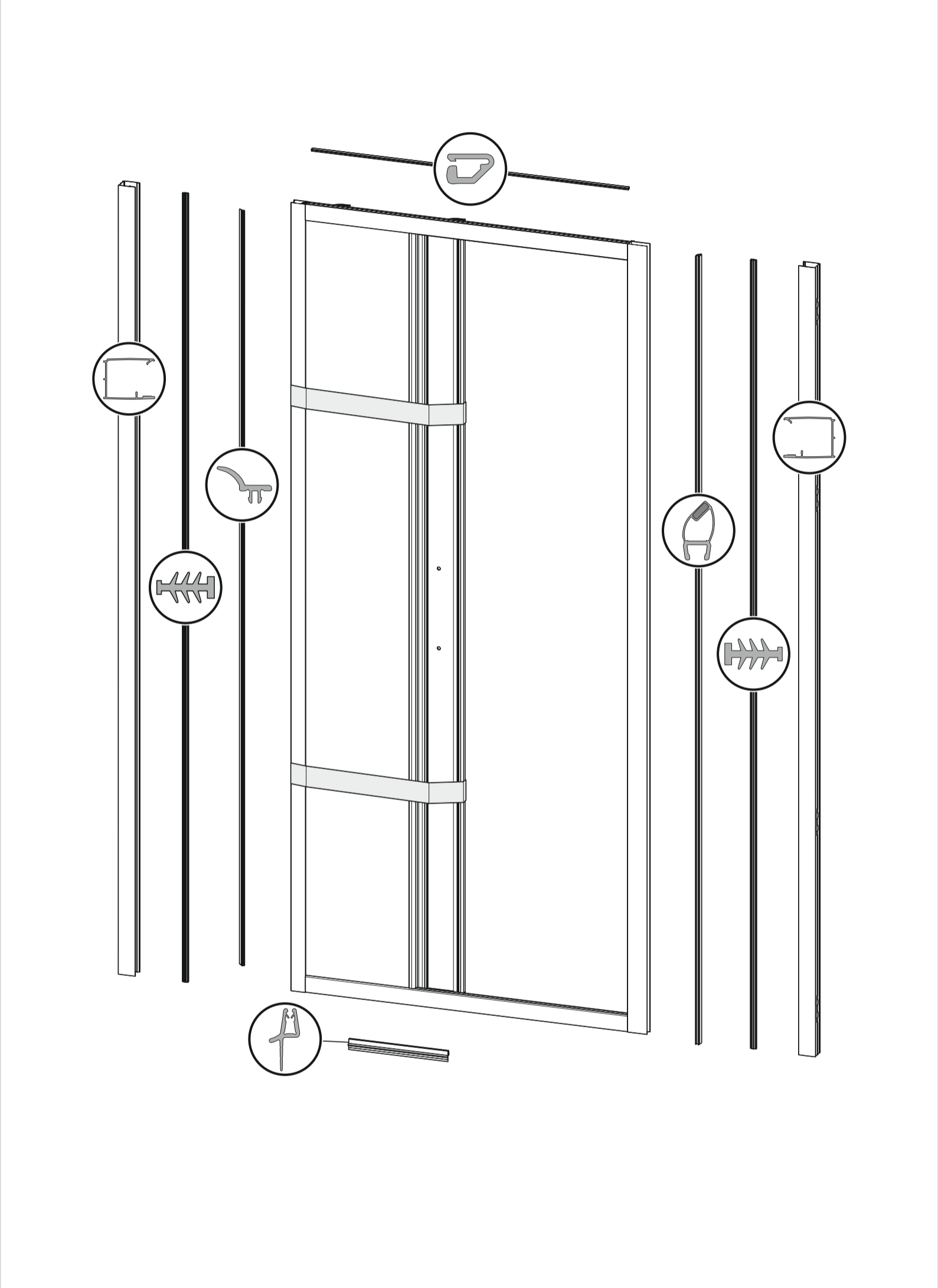
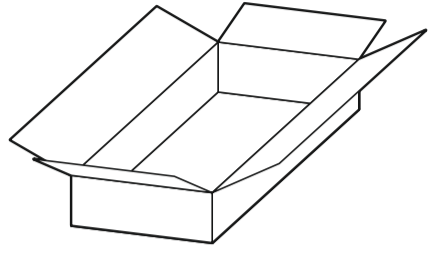
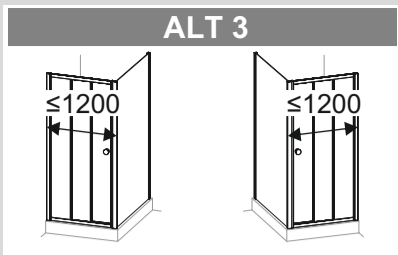
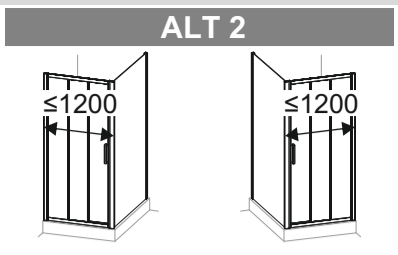
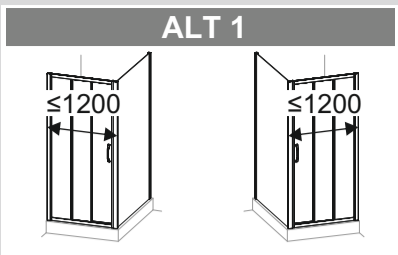

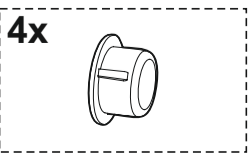
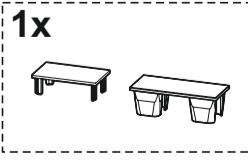
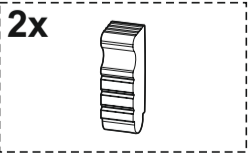
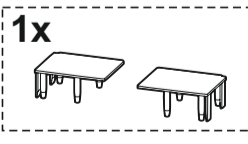
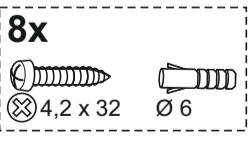
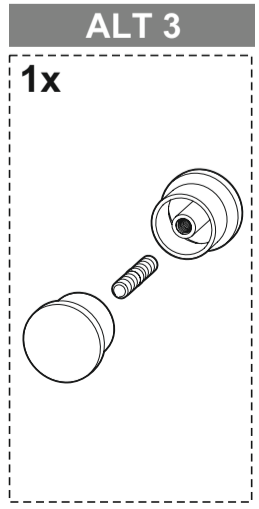
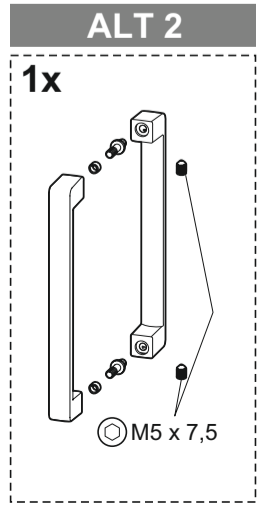
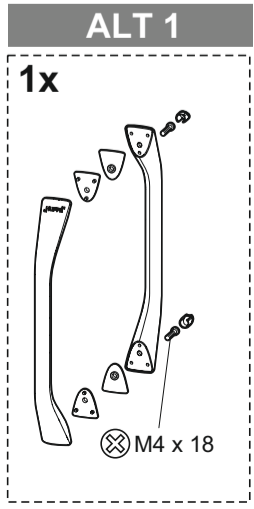
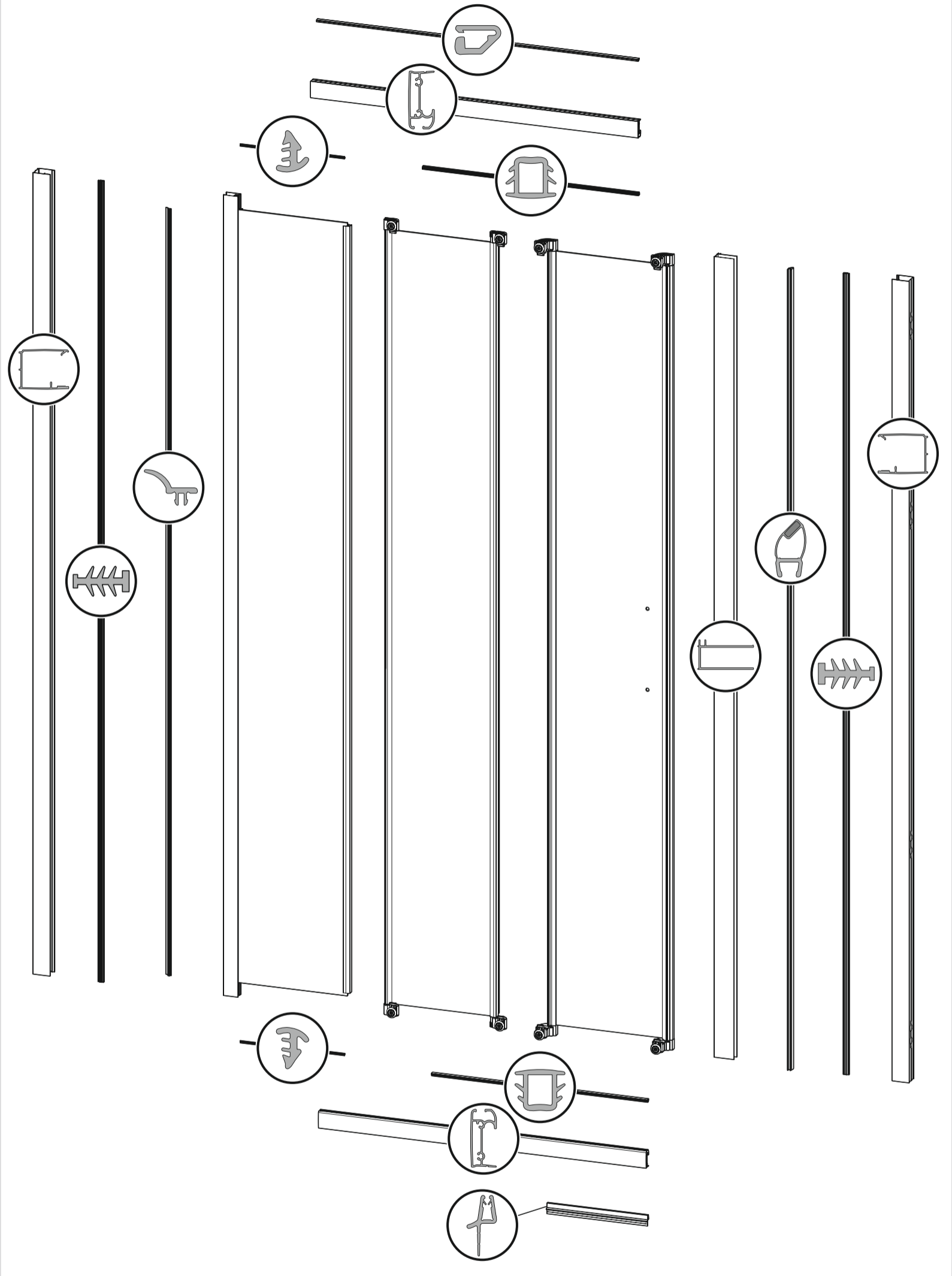
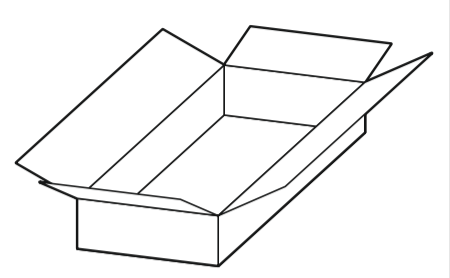
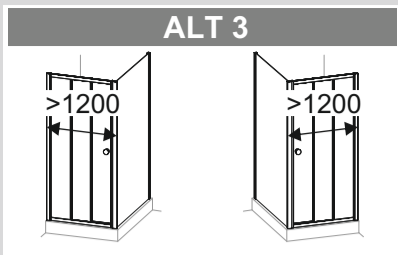
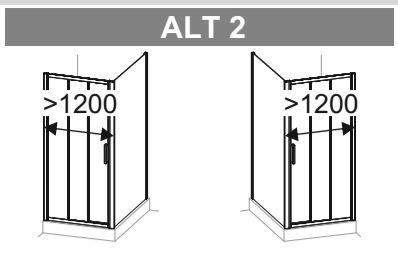
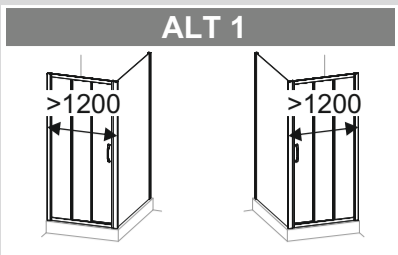

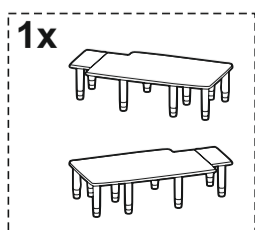
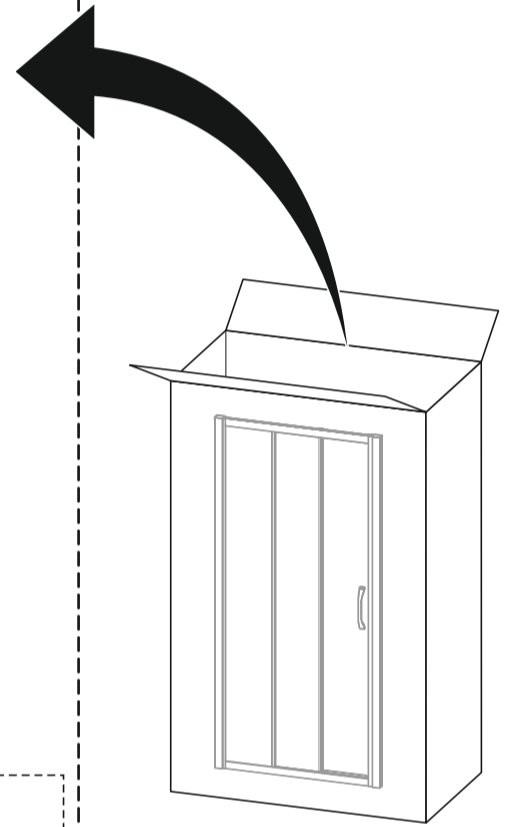
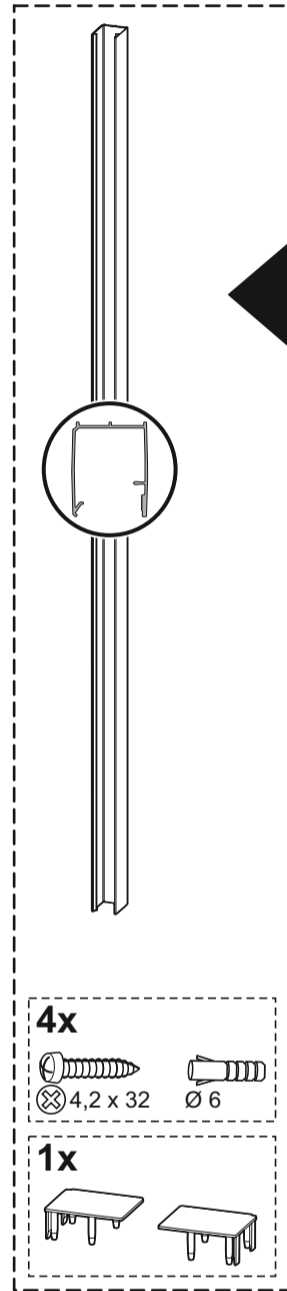
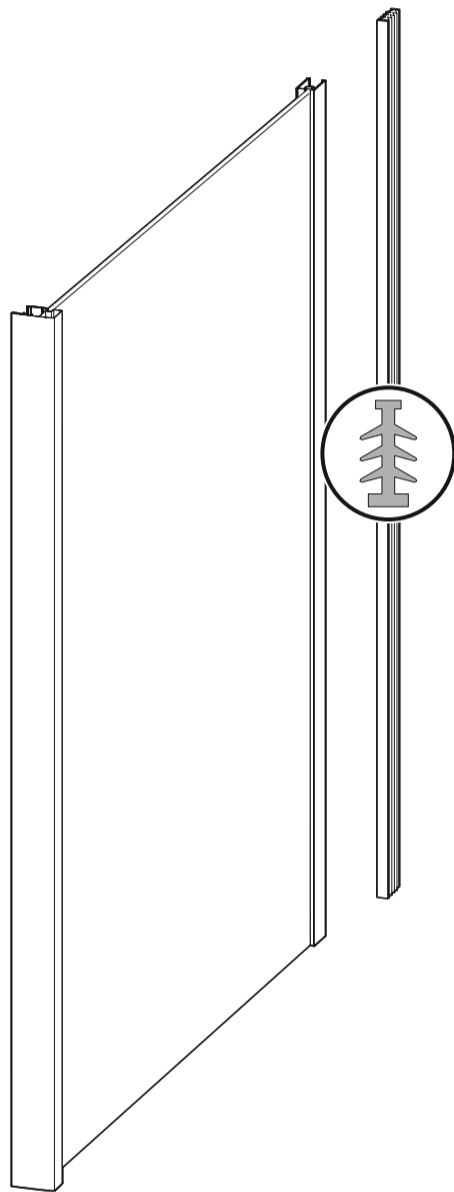
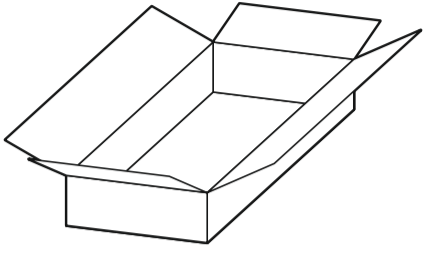

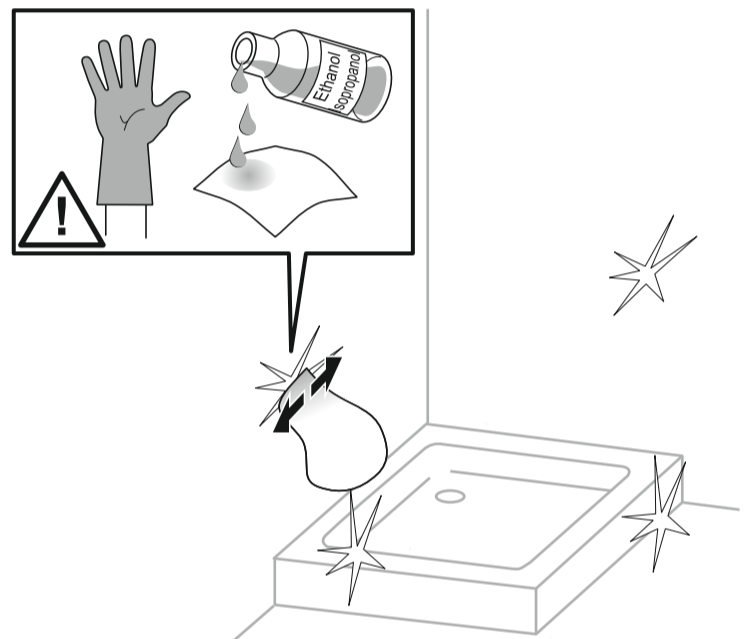
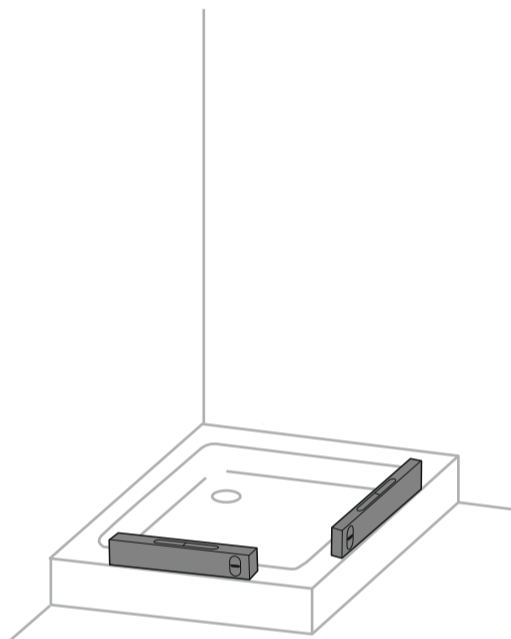
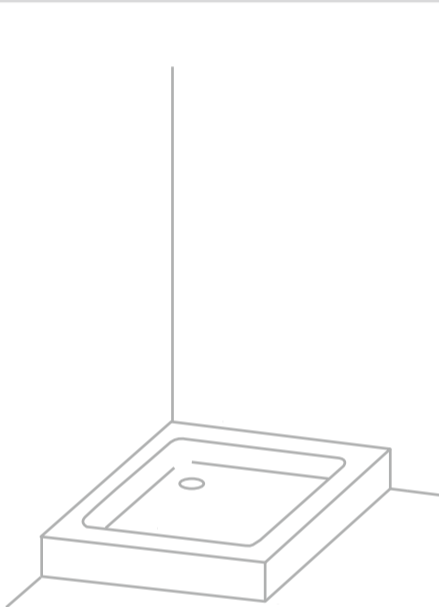
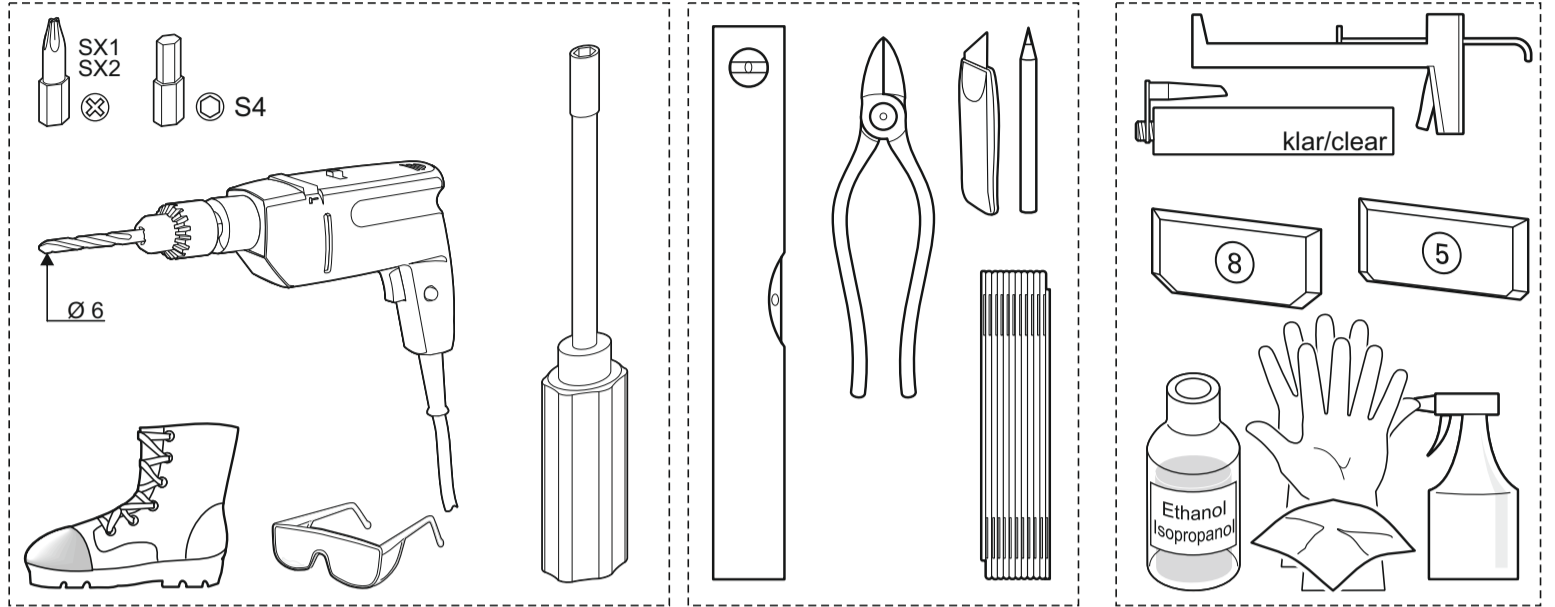
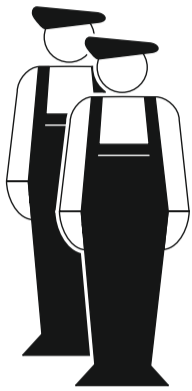
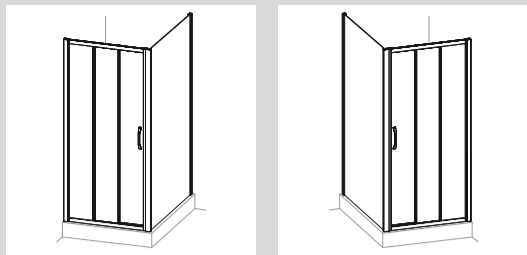

	WEM	M	ST	PT	SFT	GT	SW
D	Wanneneinbaumaß	Montagemaß Mitte Glas	Schwingtür	Pendeltür	Schwingfalttür	Gleittür	Seitenwand
CN	排水槽安装尺寸	玻璃中央安装尺寸	外开门	双向门	折叠门	移动门	侧板
CRO	Veličina za ugradnju kade	Veličina za ugradnju sredina staklo	Mimokretna vrata	Njišuća vrata	Mimokretna sklopiva vrata	Klizna vrata	Bočna stijena
CZ	Vestavný rozměr vaničky	Montážní rozměr Střed skla	Křídlové dveře	Litací dveře	Křídlové sklapovací dveře	Posuvné dveře	Boční stěna
DK	Karrets indbygningsmål	Montagemål Midt glas	Svingdør	Dobbelt svingdør	Svingfoldedør	Skydedør	Sidevæg
E	Medida de montaje de la bañera	Medida de montaje del centro del cristal	Puerta batiente	Puerta de vaivén	Puerta batiente plegable	Puerta corredera	Panel lateral
F	Cotes de montage receveur	Cotes de montage Milieu verre	Porte battante	Porte saloon	Porte pliante battante	Porte coulissante	Paroi latérale
GB	Outer tray dimension	Installation dimensions to centre of glass	Swing door	Two-way door	Folding swing door	Sliding door	Side panel
GR	Διαστάσεις τοποθέτησης ντουζιέρας	Διάσταση τοποθέτησης κέντρου κρυστάλλου	Αιωρούμενη πόρτα	Πτερυγική πόρτα	Αιωρούμενη πτυσσόμενη πόρτα	Ολισθαίνουσα πόρτα	Πλευρικό τοίχωμα
H	Zuhanytálca beépítési méret	Szerelési méret, üveg közepé	Nyílójátó	Lengőajtó	Harmonikaajtó	Tolóajtó	Oldalfal
I	Dimensione di montaggio della vasca	Dimensione di montaggio vetro centrale	Porta a battente	Porta a vento	Porta battente pieghevole	Porta scorrevole	Pannello laterale
NO	Kar-innbygningsmål	Monteringsmål Midt glass	Svingdør	Pendeldør	Svingfoldedør	Glidedør	Sidevegg
NL	Inbouwmaat bak	Montagemaat Midden glas	Zwaaideur	Pendeldeur	Zwaaivouwdeur	Schuifdeur	Zijwand
P	Medida de instalação da banheira	Medida de montagem centro do vidro	Porta de batente	Porta de vaivém	Porta de fol e de batente	Porta de correr	Painel lateral
PL	Warunki zabudowy na brodziku	Wymiar montażowy środka szyby	Drzwi skrzydłowe	Drzwi wahadłowe	Drzwi skrzydłowe składane	Drzwi suwane	Ścianka boczna
ROM	Dimensiune de montare cadă	Dimensiune de montaj geam pe mijloc	Ușă batantă	Ușă pivotantă	Ușă pliabilă	Ușă glisantă	Perete lateral
RU	Установочный размер поддона	Монтажный размер Центр стекла	Распашная дверь	Дверь, открывающаяся вовнутрь и наружу	Распашная складывающаяся дверь	Раздвижная дверь	Боковая стенка
SER	Ugradne dimenzije kade	Dimenzije za montažu Sredina stakla	Obrtna vrata	Vrata koja se mogu otvoriti u oba pravca	Obrtna vrata koja se mogu preklopiti	Klizna vrata	Bočni zid
S	Karinbyggnadsmått	Monteringsmått mitten glas	Slagdörr	Pendeldörr	Slagvikdörr	Skjutdörr	Sidovägg
SF	Altaan asennusmita	Lasin keskiosan asennusmita	Kääntöovi	Heiluriovi	Taitettava kääntöovi	Liukuovi	Sivuseinä
SK	Vstavaný rozmer vaničky	Montážny rozmer Stred skla	Křídlové dveře	Lietacie dveře	Křídlové sklapovacie dveře	Posuvné dveře	Bočná stena
SLO	Vgradne dimenzije kadi	Montažna dimenzija sredina stekla	Nihajna vrata	Nihalna vrata	Nihajna zložljiva vrata	Drсна vrata	Bočna stena
TR	Küvet montaj ölçüsü	Cam ortası montaj ölçüsü	Döner kapı	Amerikan kapı	Döner katlanır kapı	Sürgülü kapı	Yan duvar

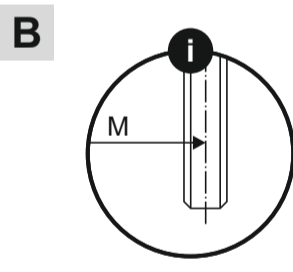
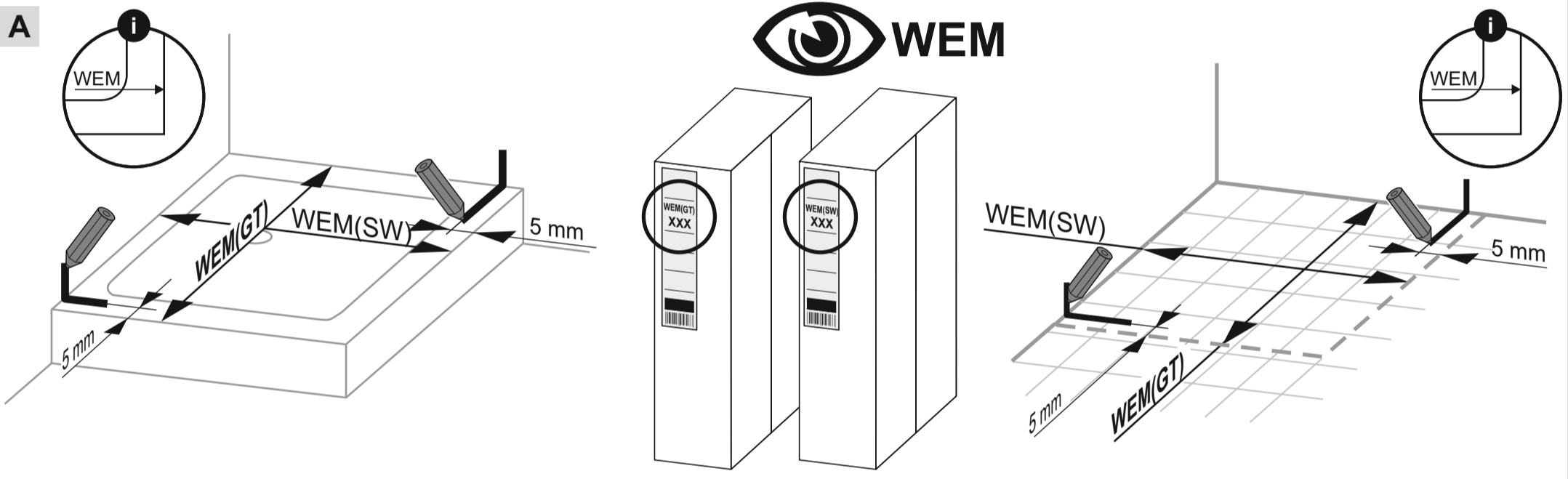
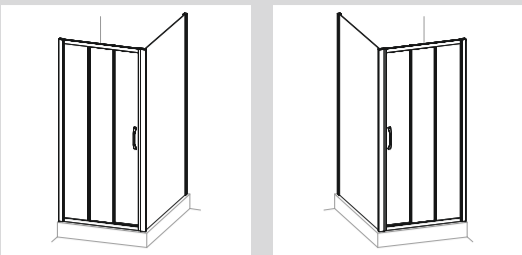

- Achtung:**
Diese Montagesituation ist nur gültig, wenn das Maß "M" auf dem Karton steht - Maßanfertigung auf Mitte Glas.
- Pozor:**
Ova situacija pri ugradnji vrijedi samo ako na kartonu stoji veličina "M" - izrada po mjeri prema sredini stakla.
- 注意:**
此安装情形只在纸箱上注有"M"尺寸时才适用, 即根据玻璃中央尺寸定制。
- Pozor:**
Tato situace při montáži platí jen tehdy, když je na krabici uveden rozměr "M". - výroba na míru na střed skleněné tabule
- Bemærk:**
Denne montagesituation gælder kun, hvis målet "M" står på papkassen - specialfremstilling på midten af glasset.
- Atención:**
Esta situación de montaje sólo es válida si la medida "M" figura sobre el cartón - Construcción a medida respecto al centro del cristal
- Attention:**
Cette situation de montage n'est valable que si la mesure "M" est mentionnée sur le carton - Réalisation sur mesure milieu verre.
- Note:**
This installation situation only applies if the dimensions "M" are specified on the box - made-to-measure design acc. to glass centre.
- Προσοχή:**
Η απεικονιζόμενη κατάσταση τοποθέτησης ισχύει μόνο, όταν υπάρχει τυπωμένη η διάσταση "M" στο χαρτόνι-Κατασκευή διαστάσεων στο κέντρο τζαμιού.
- Figyelem:**
Ez a szerelési helyzet csak akkor érvényes, ha az „M” méret található a kartonon – Méretre gyártás: az üveg középvonalaig számítva.
- Attenzione:**
Questa situazione di montaggio vale soltanto se sul cartone è indicata la misura "M" - produzione su misura al centro del vetro.

- Let op:**
Deze montagesituatie geldt uitsluitend wanneer de maat "M" op de doos staat – speciaal maatwerk op midden glas.
- Merk:**
Følgende anvisning gjelder kun hvis målet "M" står på kartongen – produksjon etter mål fra midten av glasset.
- Atenção:**
Esta situação de montagem aplica-se apenas com a medida "M" indicada na embalagem – feito a medida, com ponto de referência no centro do vidro.
- Uwaga:**
Ta sytuacja montażowa występuje tylko w przypadku podania wymiaru „M” na kartonie – wykonanie na wymiar na środek szyby.
- Atenție:**
Acest caz de montare este valabil numai dacă pe ambalaj este înscrisă mărimea "M" - variantă de execuție la mijlocul geamului.
- Будьте внимательны:**
Такая ситуация при сборке верна только тогда, когда на картонной коробке указан размер "M" — это нестандартное изготовление по заказу посередине стекла.
- Observera:**
Monteringssituationen gäller endast när måttet "M" står på kartongen – måttillverkning mitt på gaset.
- Oppez:**
Prikazana situacija na slici važi samo ako na kartonu stoji vrednost "M" - mera je prilagodena vrednosti na sredini stakla.
- Huomio:**
Tämä asennustilanne pätee vain, kun laatikossa lukee mitta "M" - valmistettu mittatytönä lasin keskelle.
- Pozor:**
Táto montážna situácia je platná len vtedy, keď stojí rozmer "M" na kartóne - zhotovenie na mieru na strede skla.
- Pozor:**
Ta položaj montaže je veljaven samo v primeru, če se na kartonu nahaja mera "M" - izdelano po meri na sredino stekla.
- Dikkat:**
Bu montaj durumu ancak kartonun üzerindeki ölçü „M” ise geçerlidir – Ölçü üretimi camın ortasına göredir.

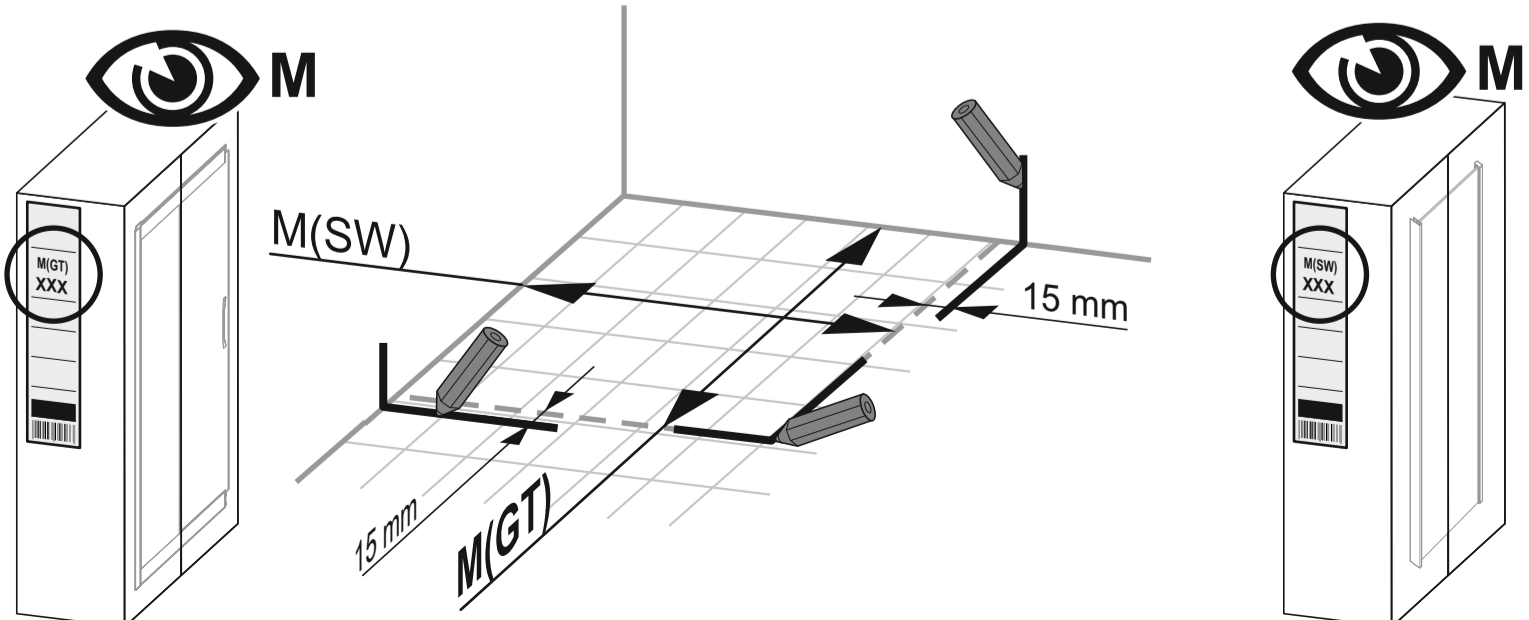

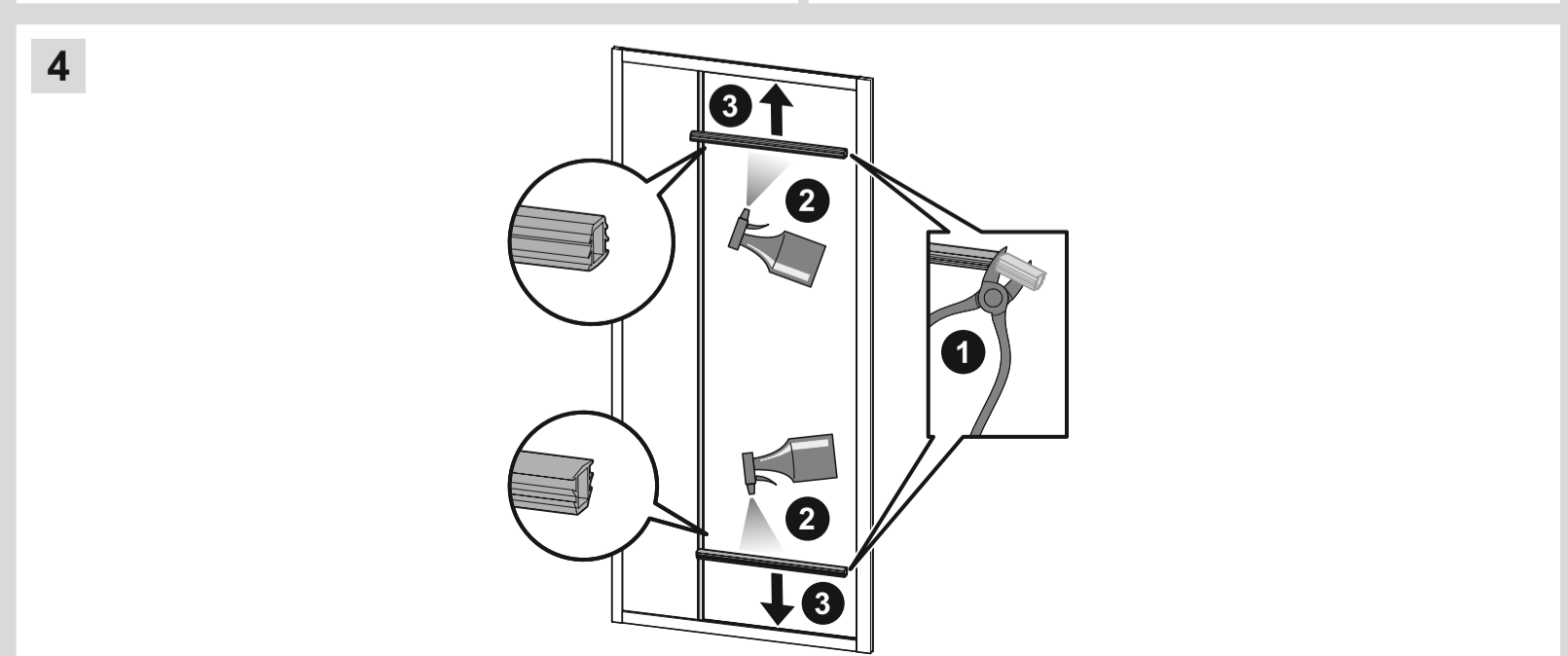
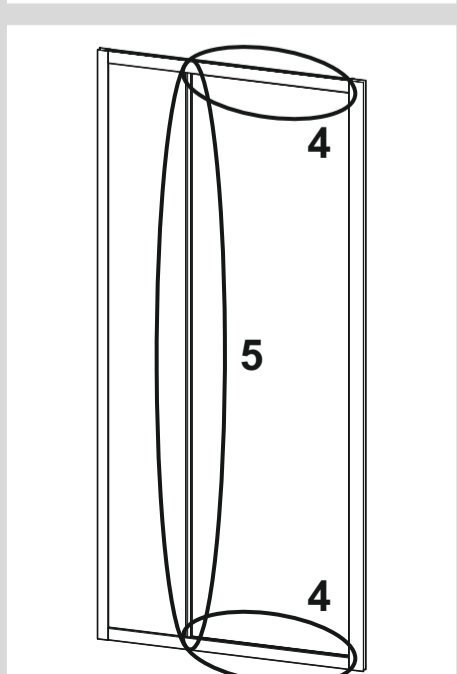
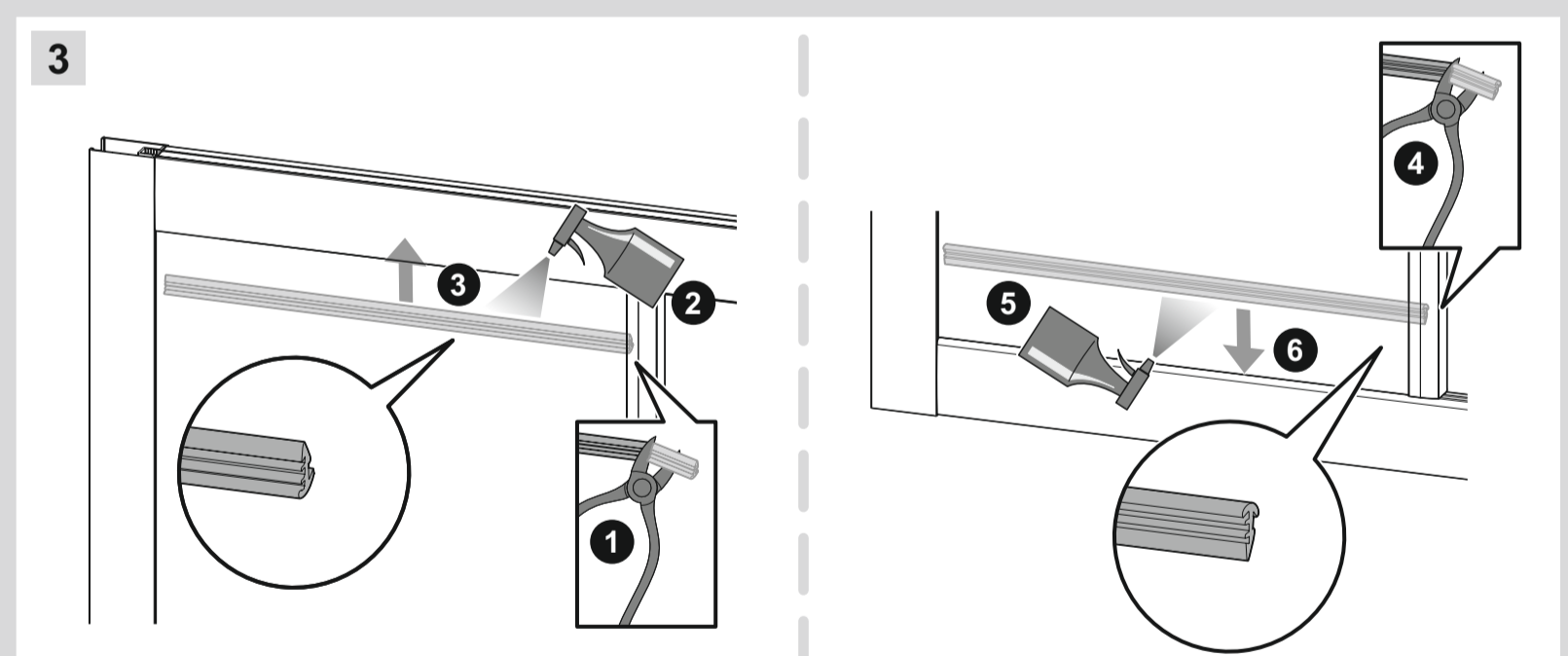
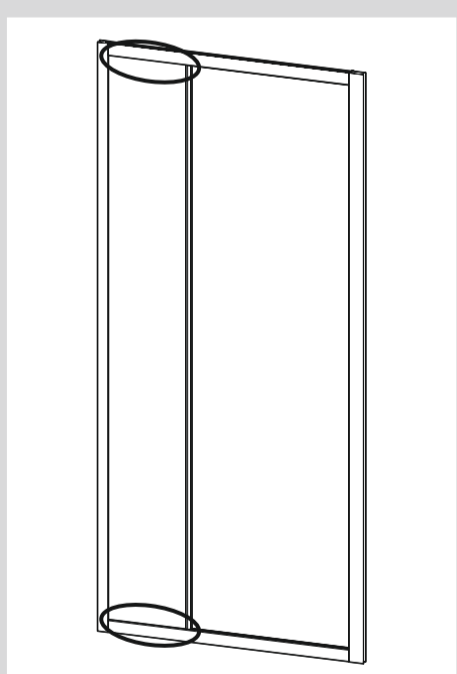
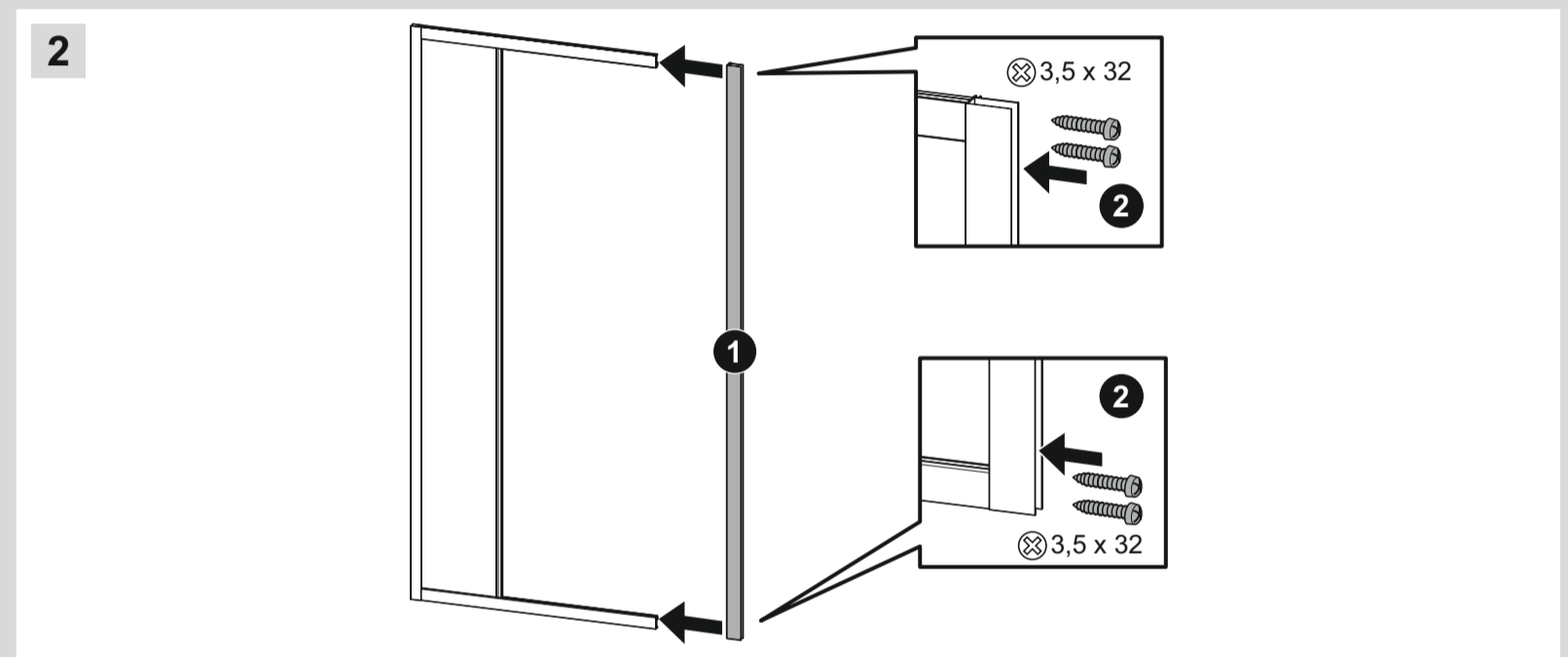
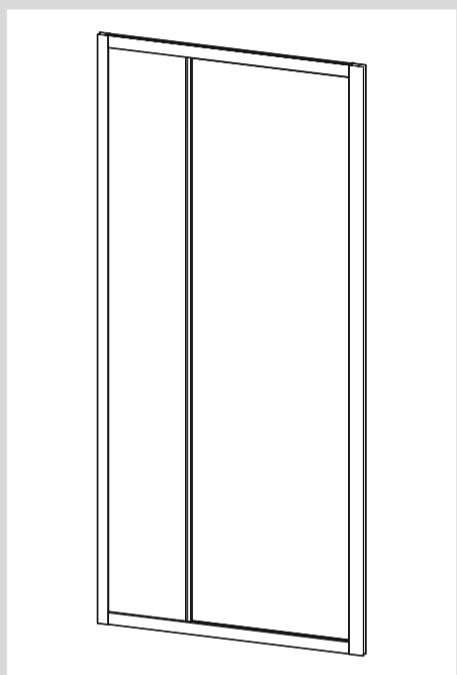
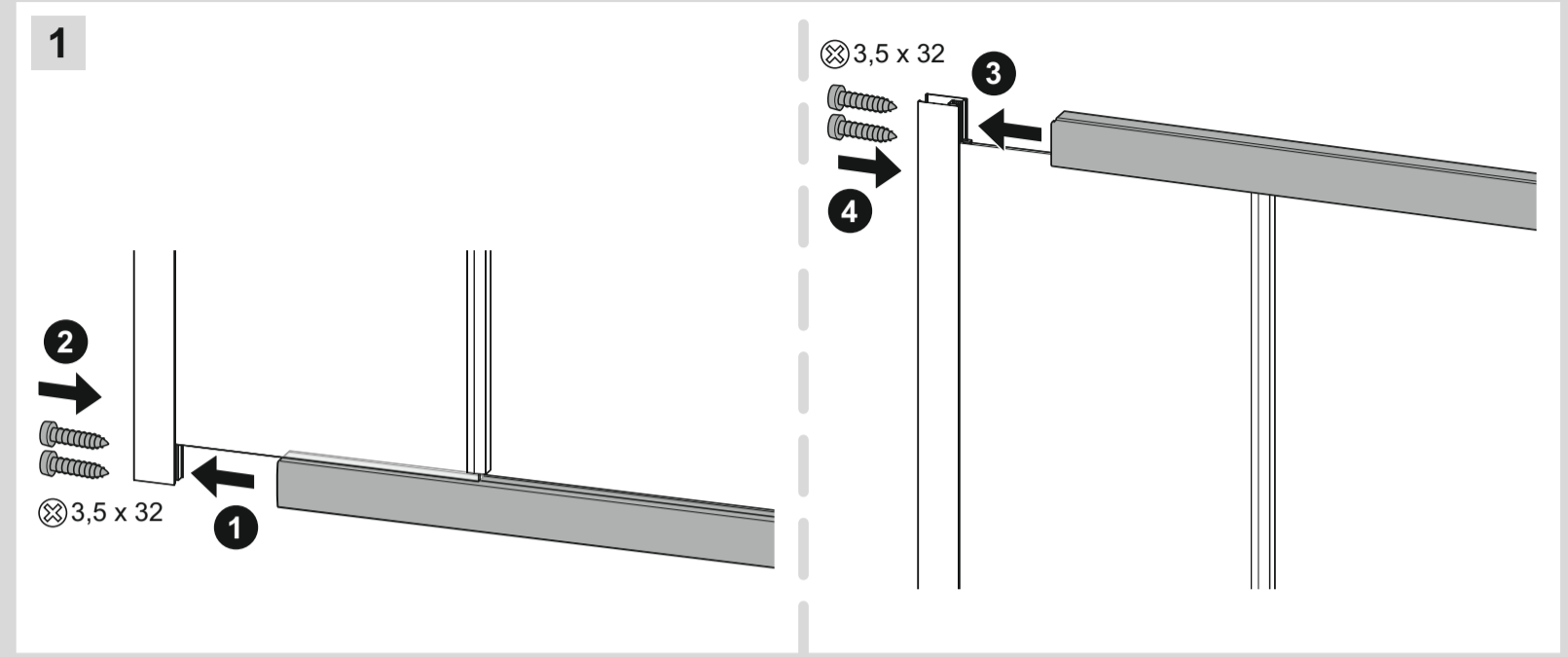
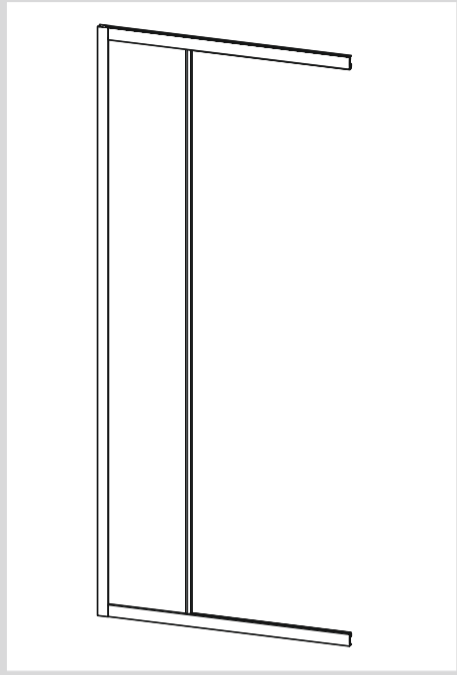
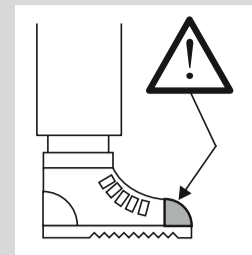
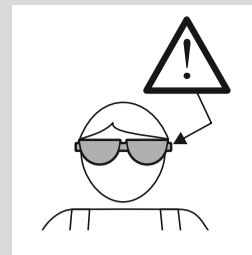
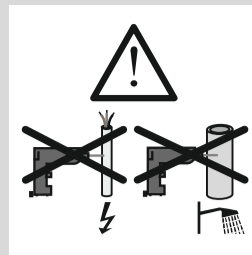
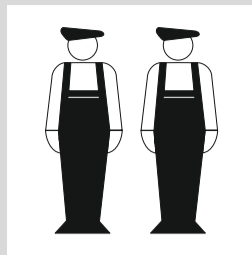
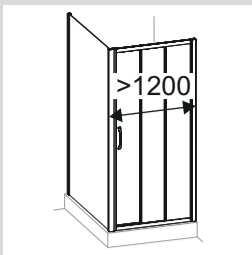

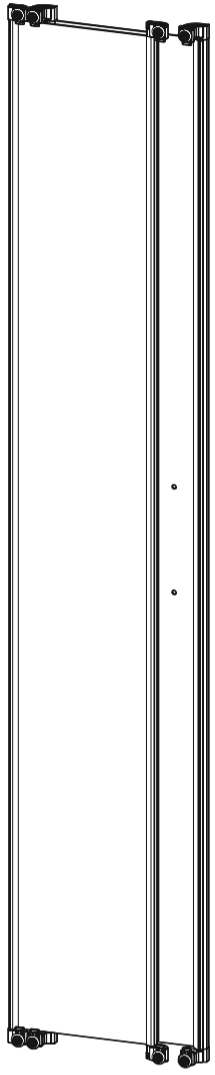
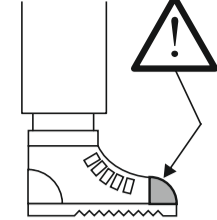
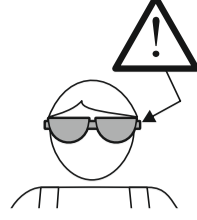
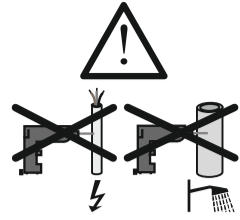
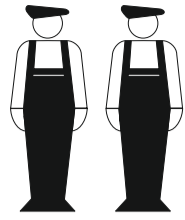
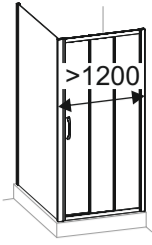
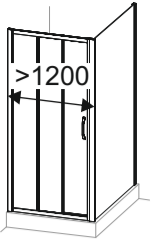

5

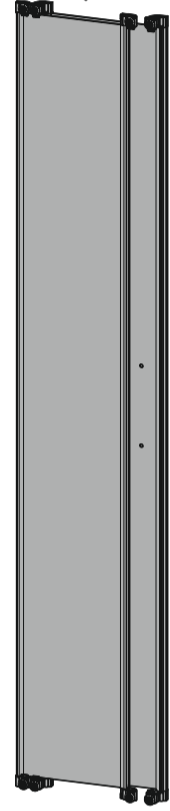
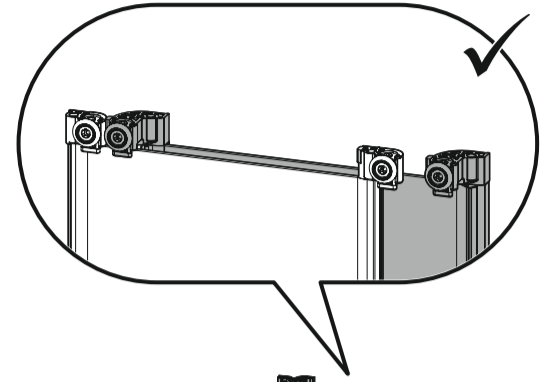
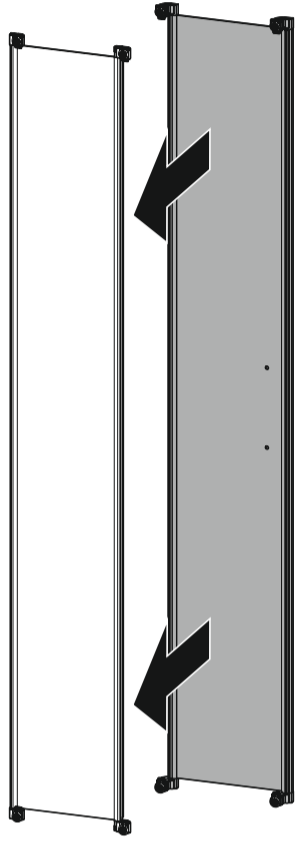

6

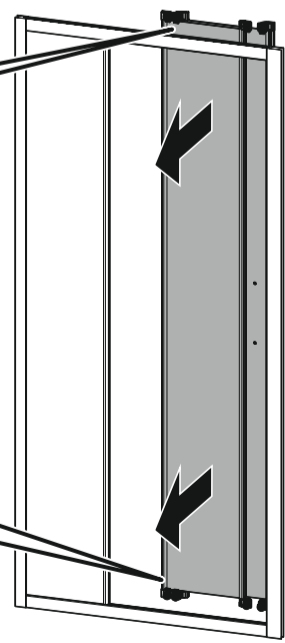
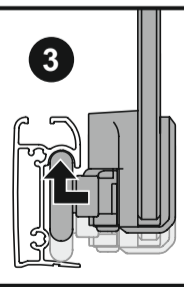
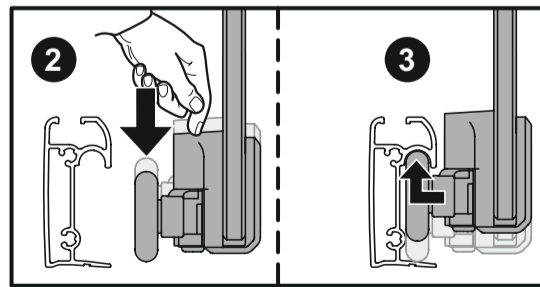
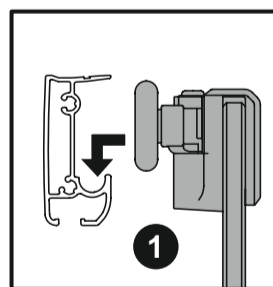
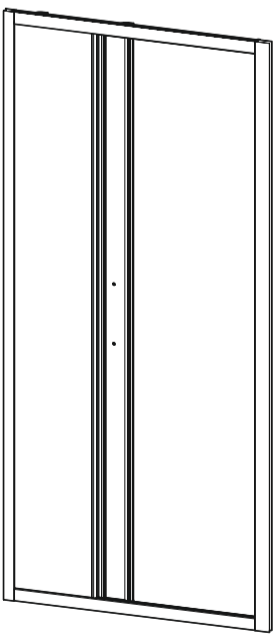

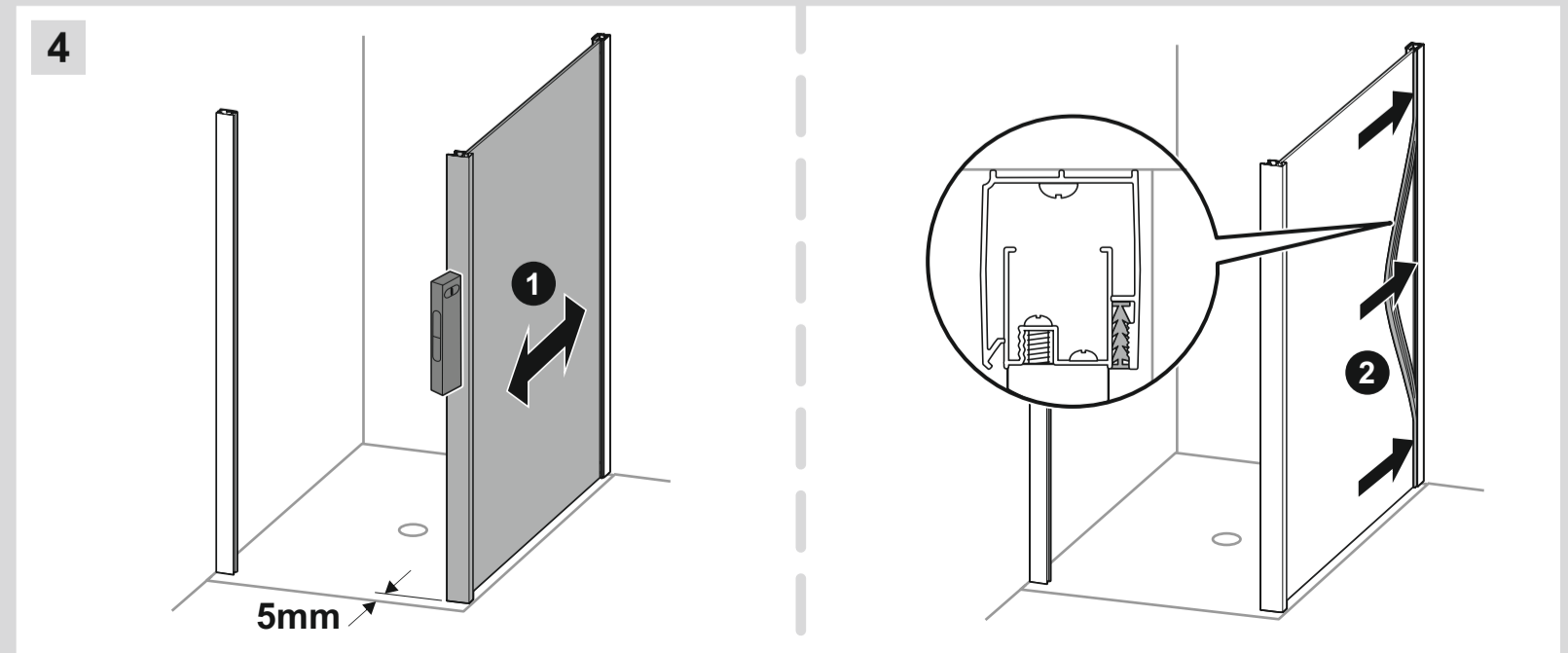
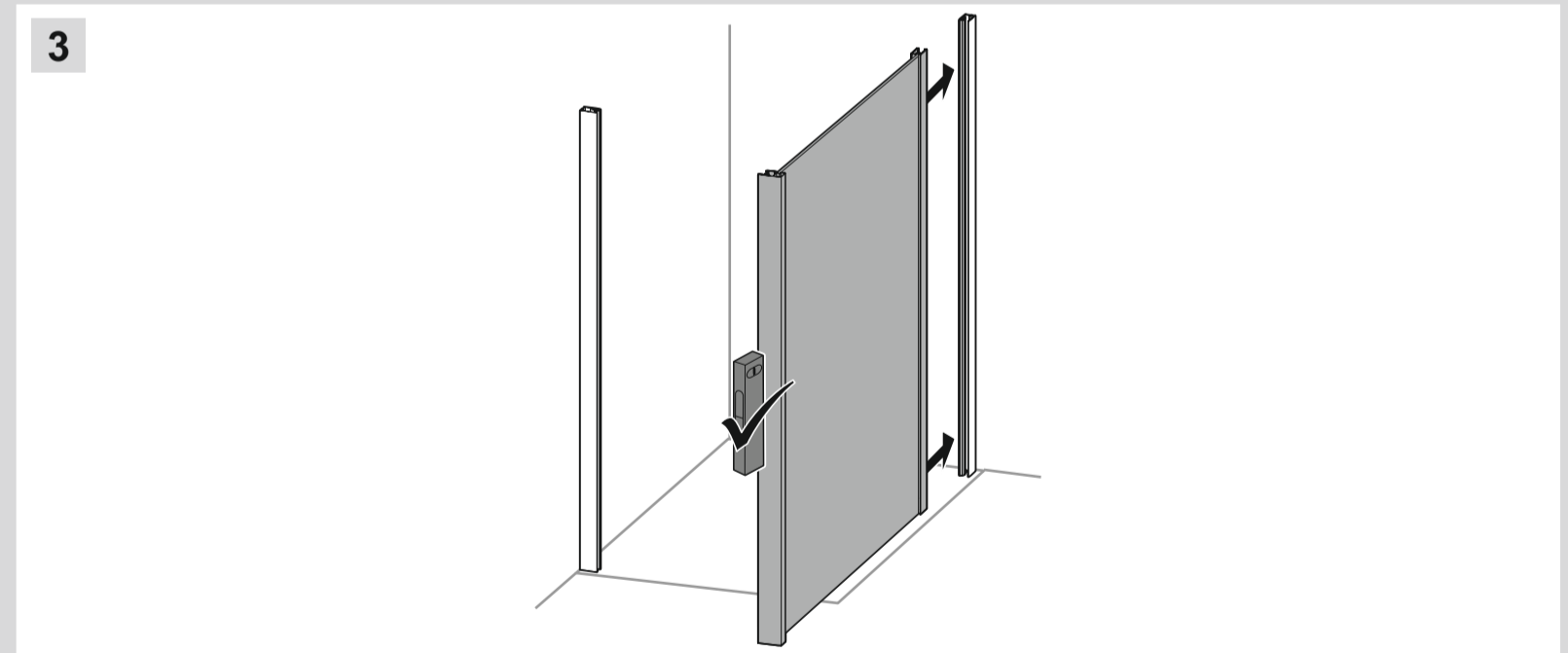
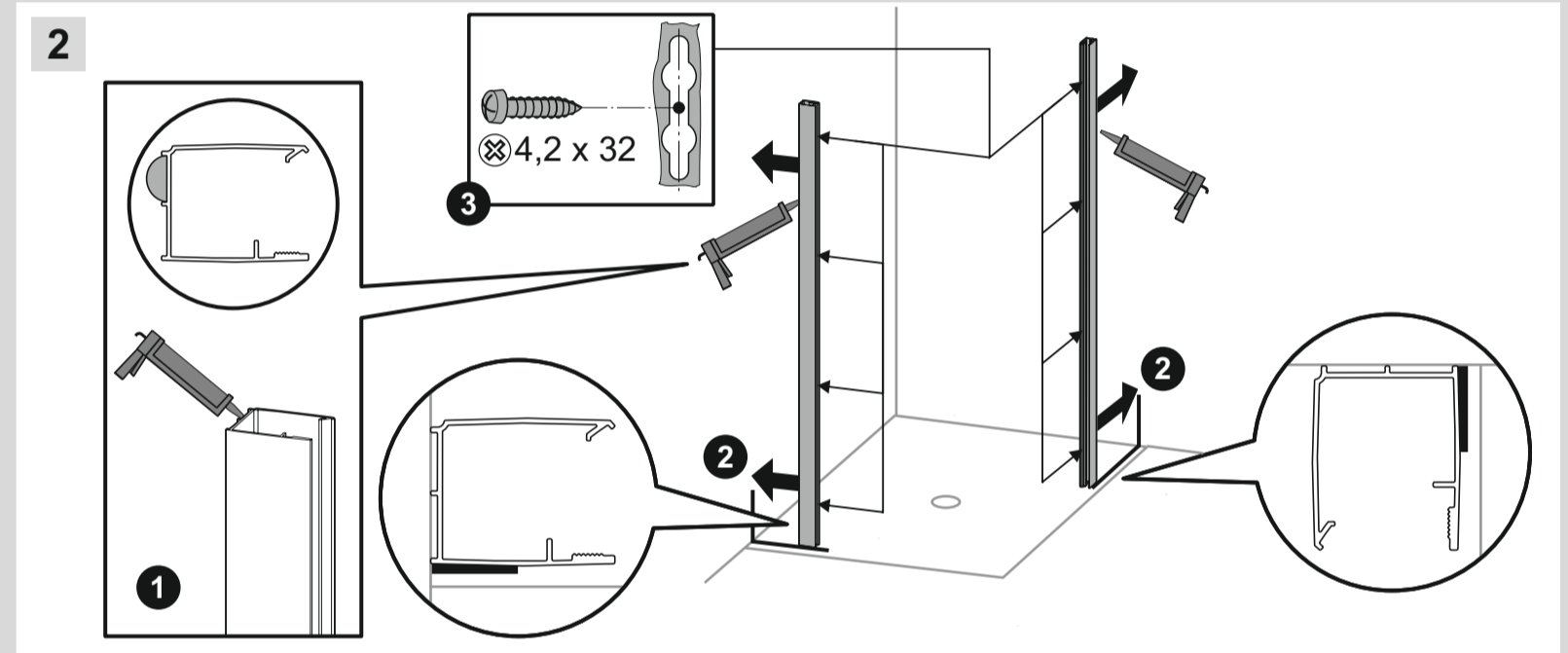
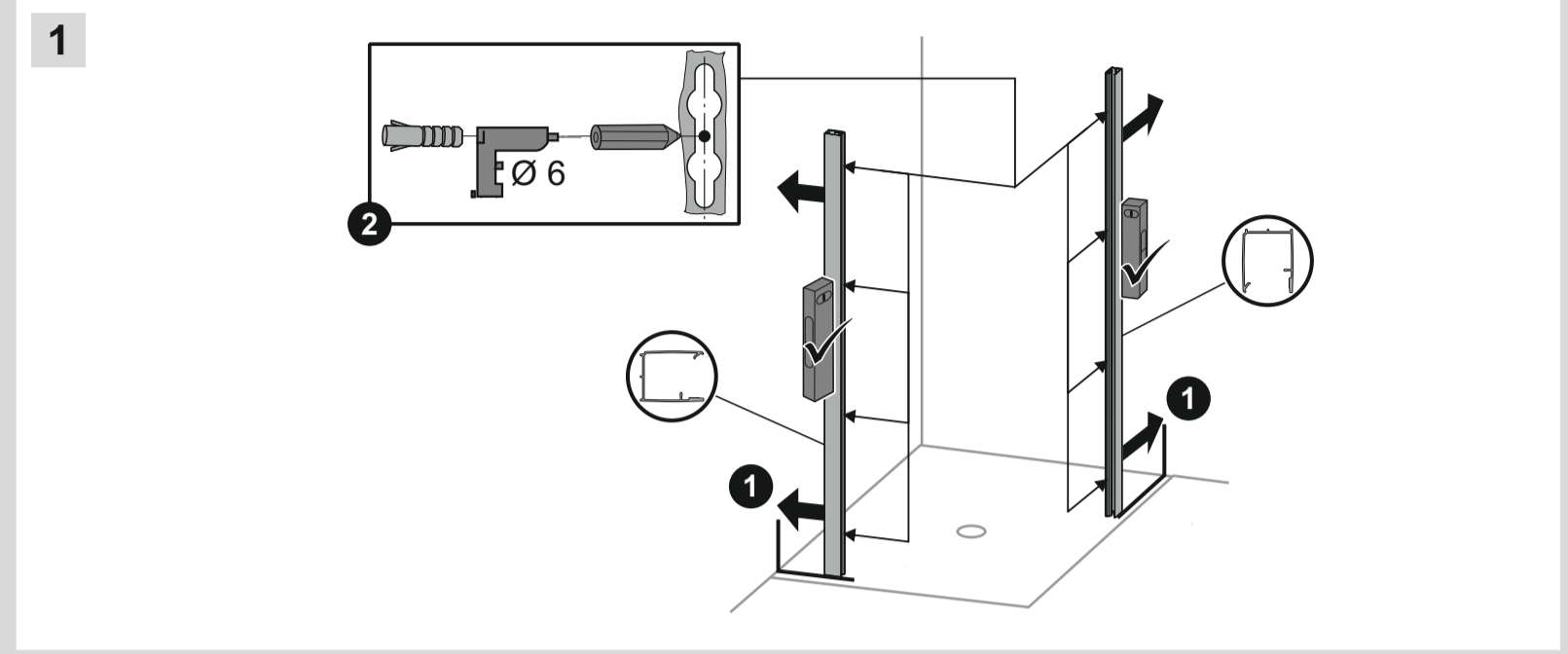
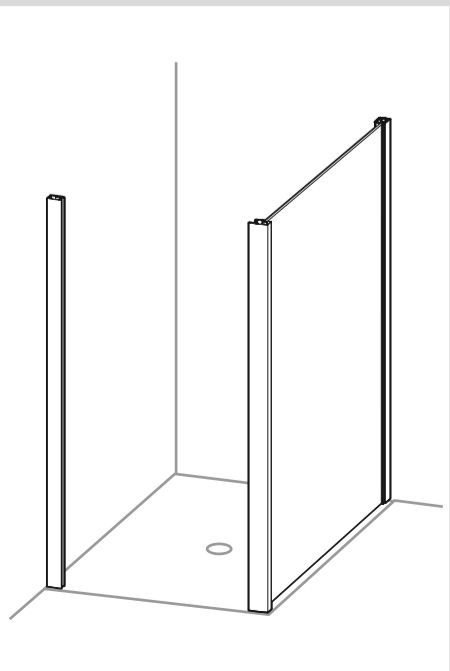
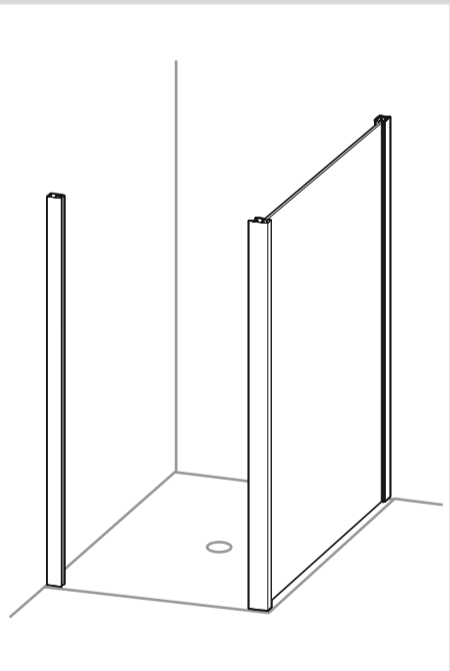
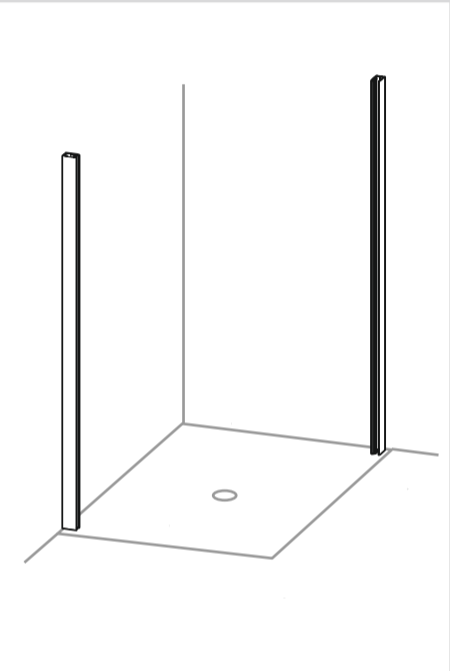
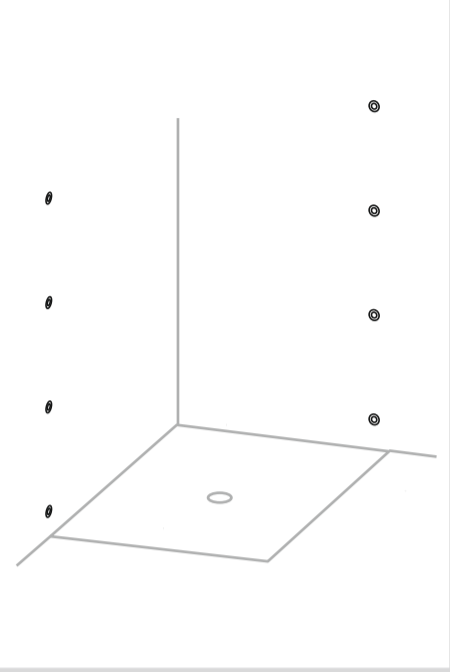
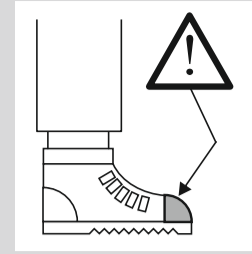
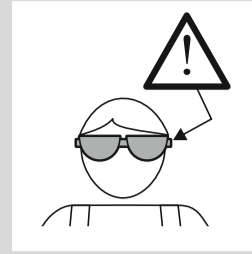
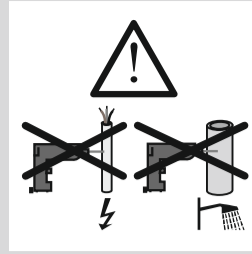
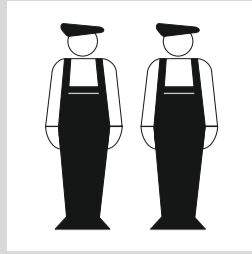

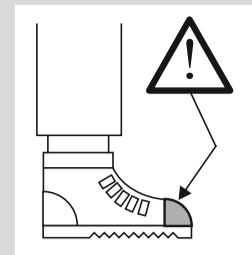
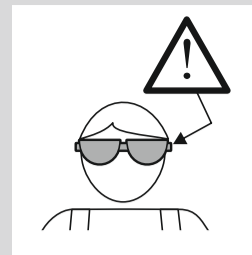
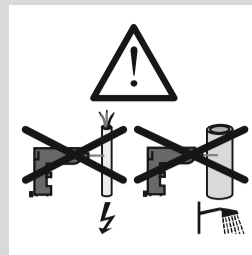
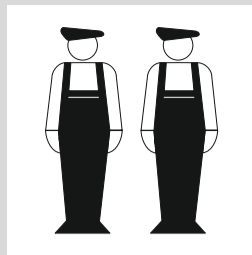

ALT 1

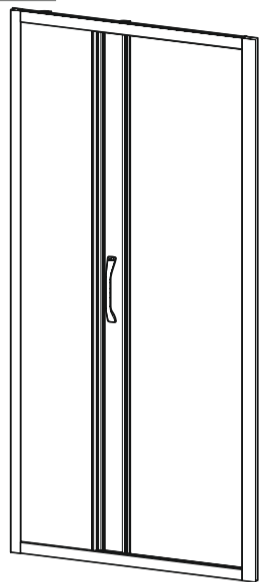

5a

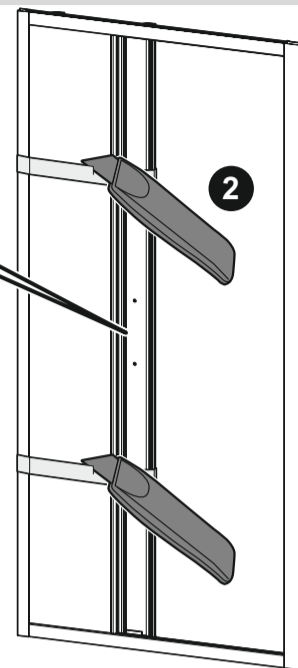
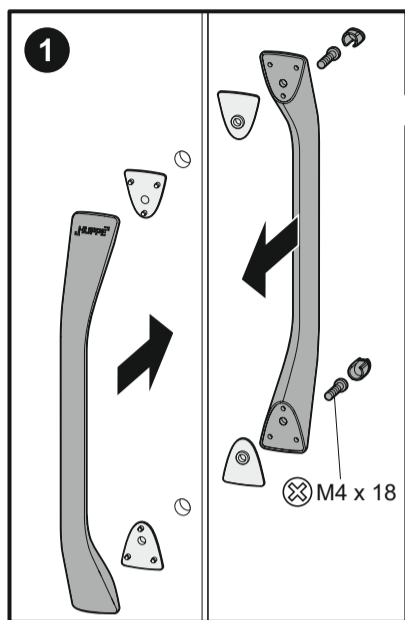

ALT 2

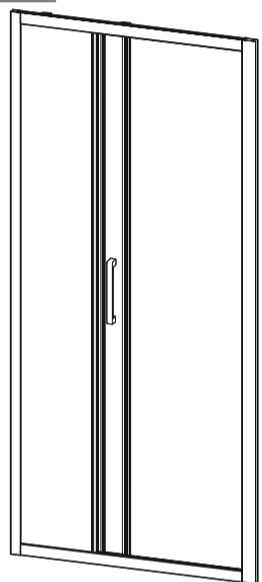

5b

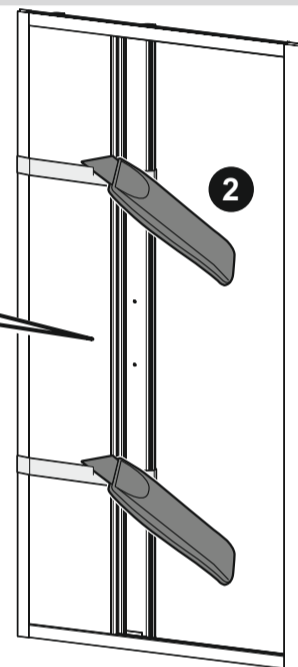
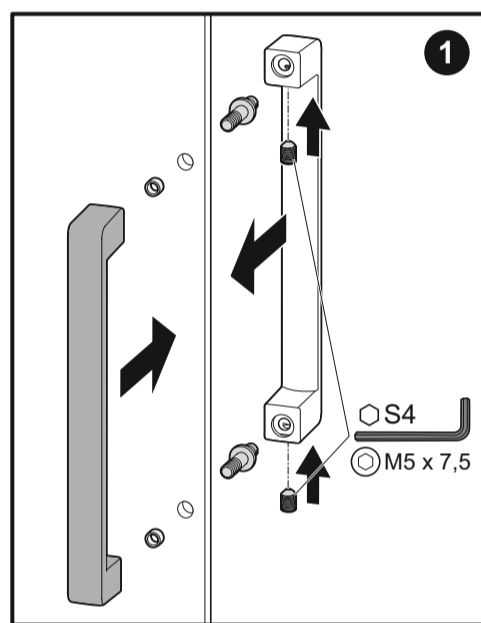

ALT 3

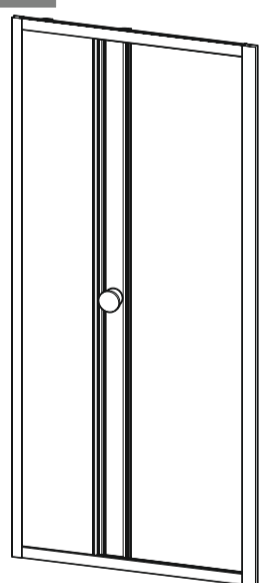

5c

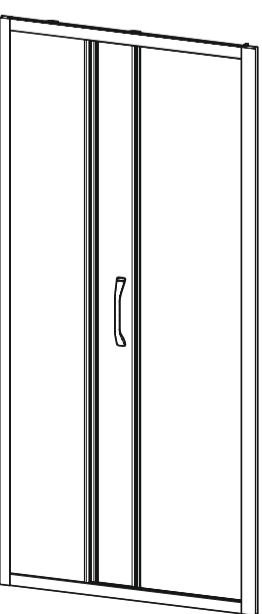
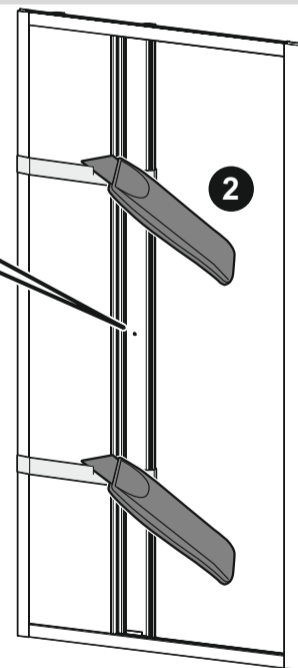
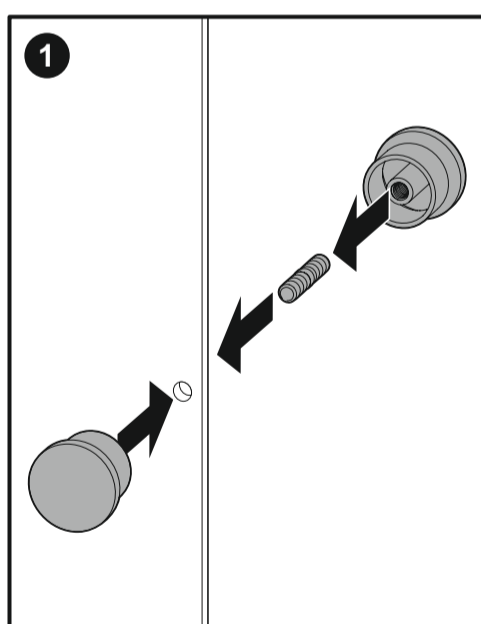

6

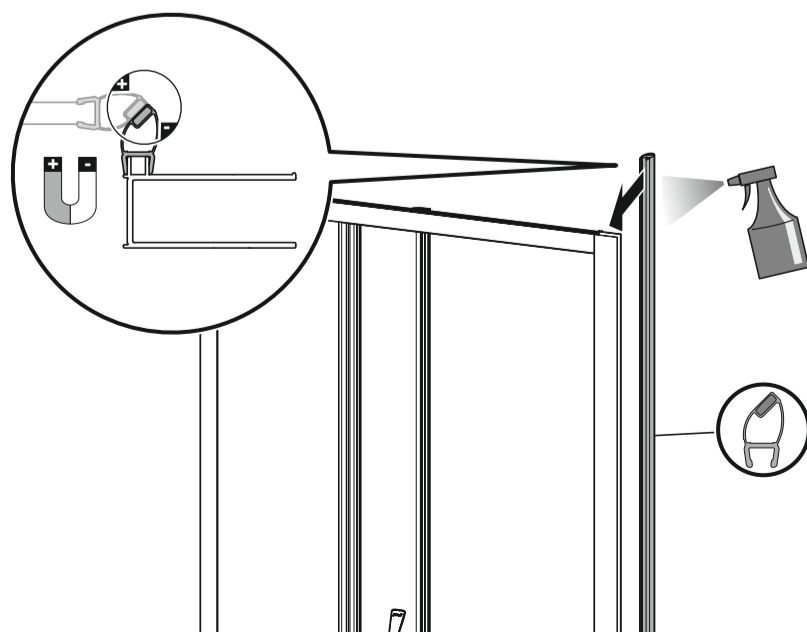

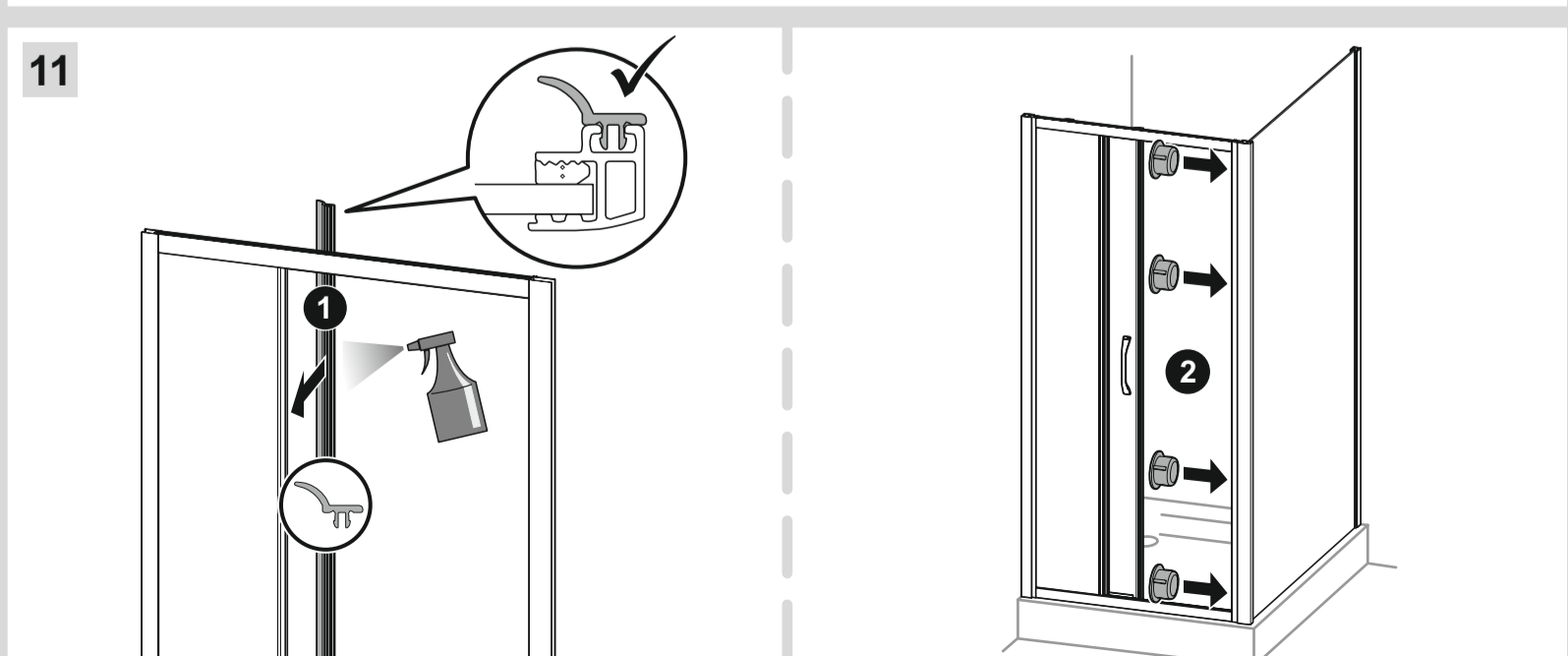
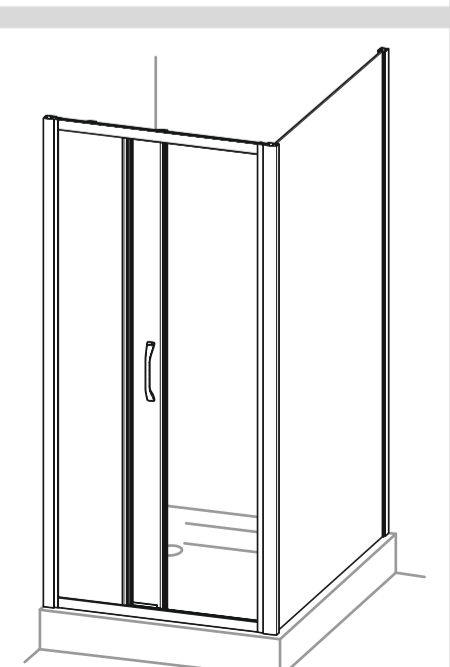
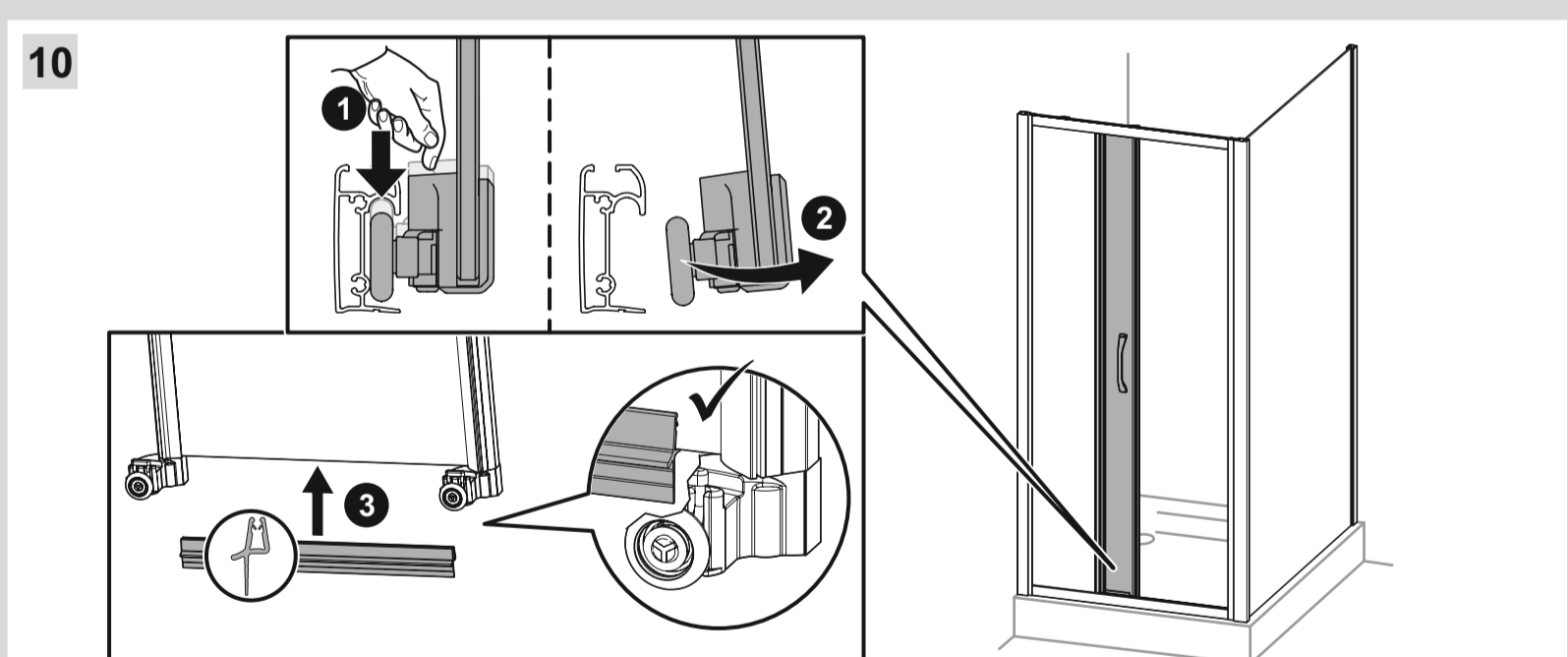
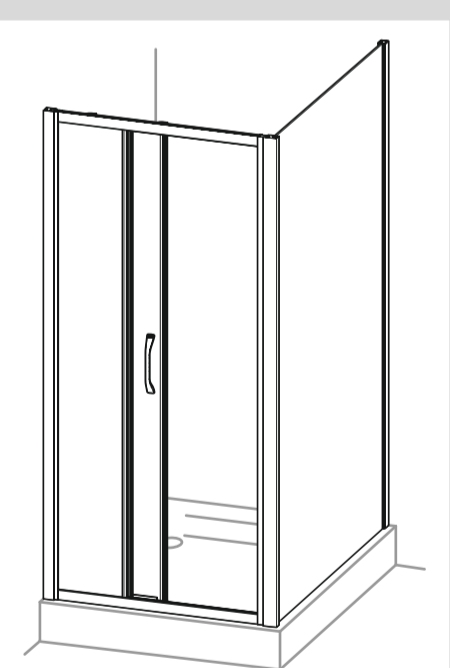
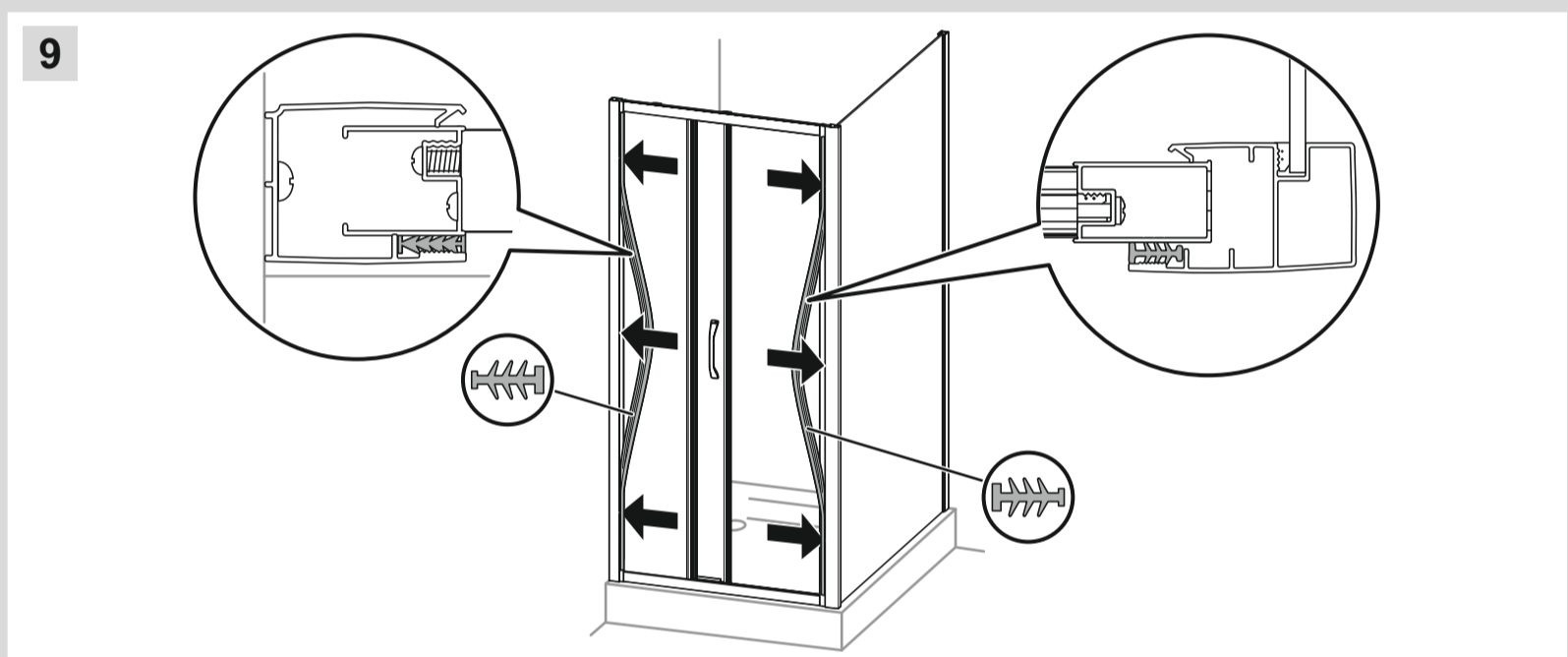
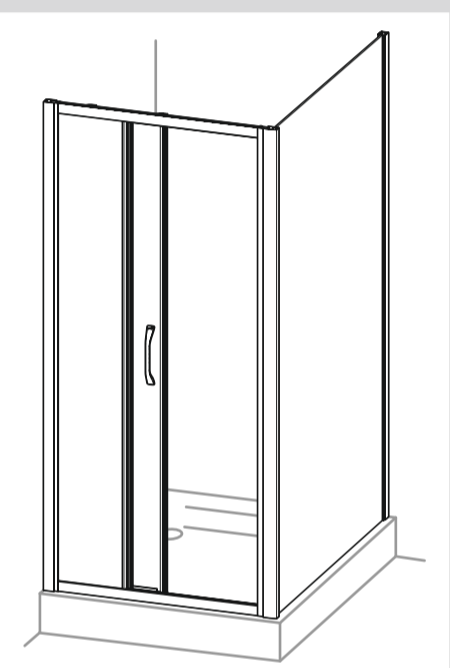
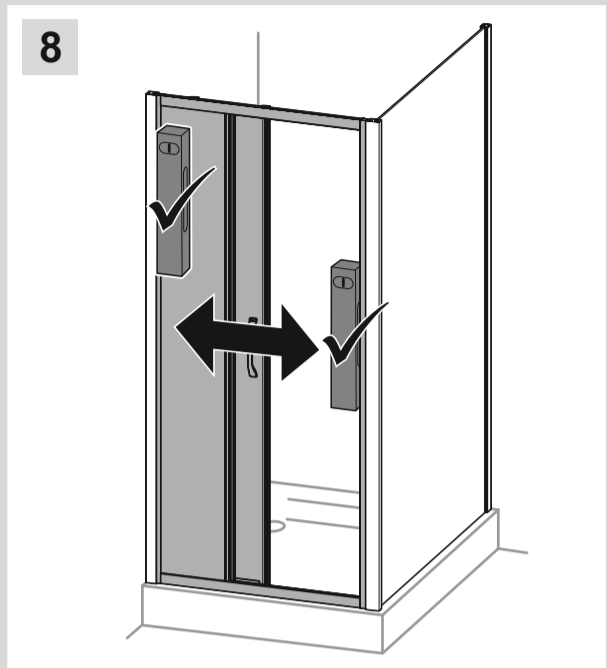
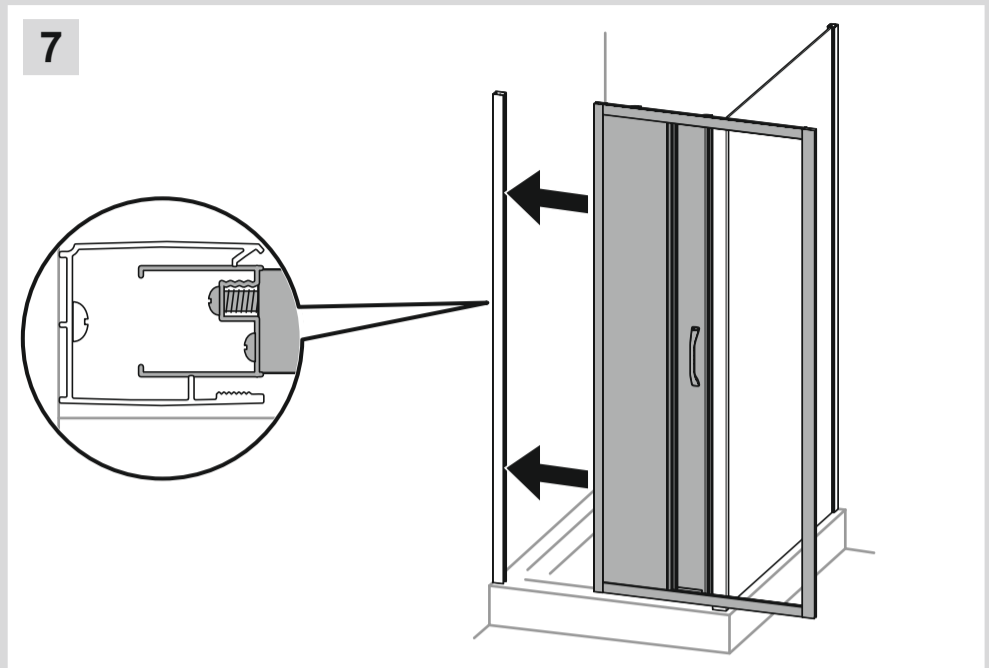
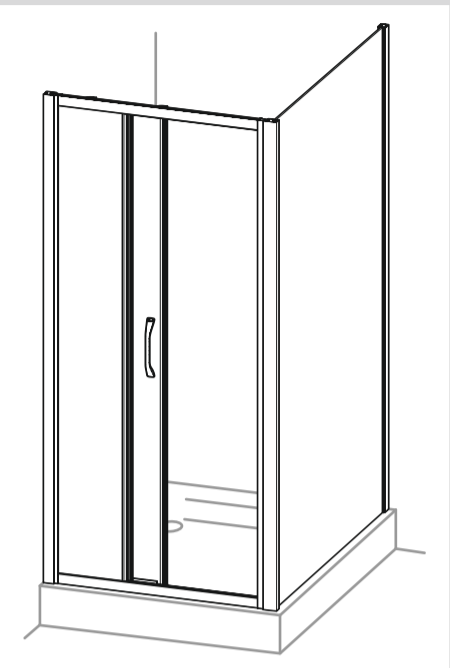
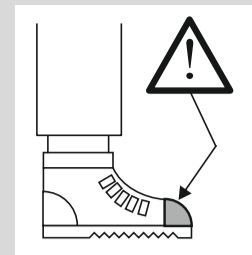
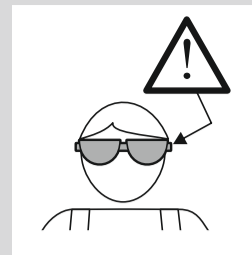
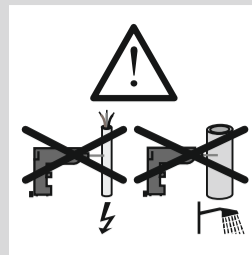
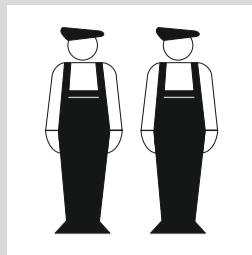

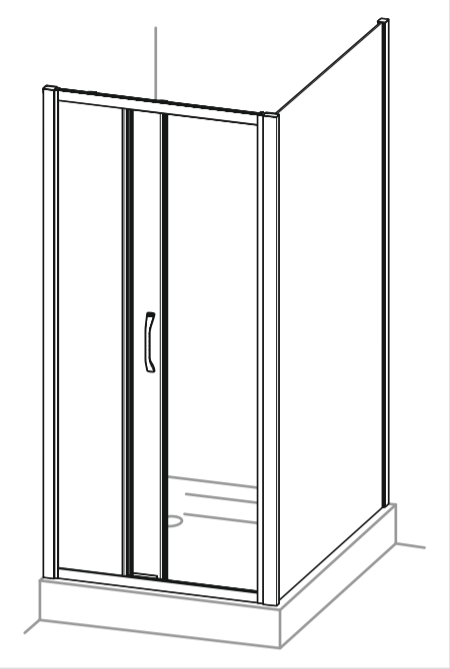
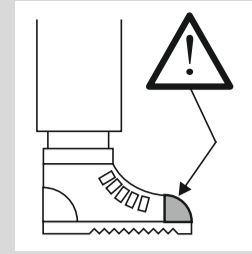
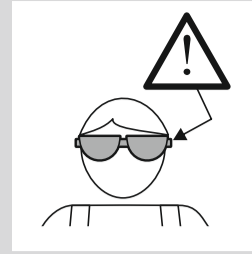
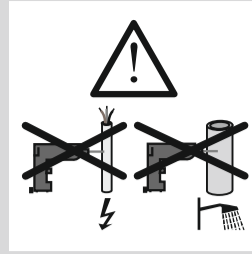
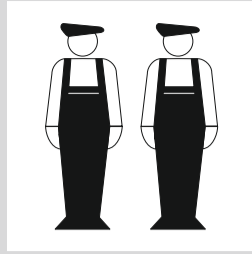

12

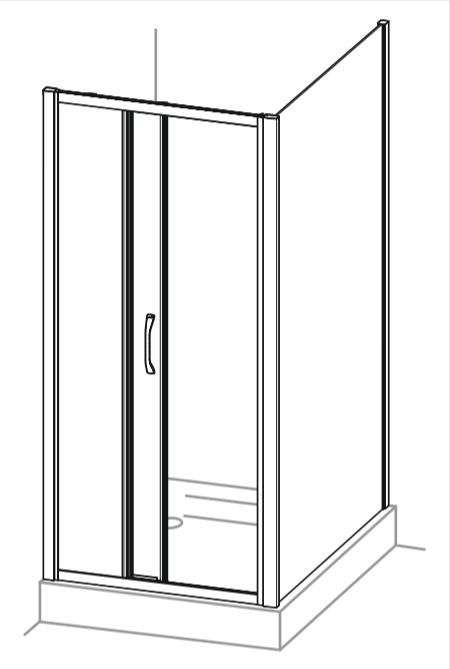
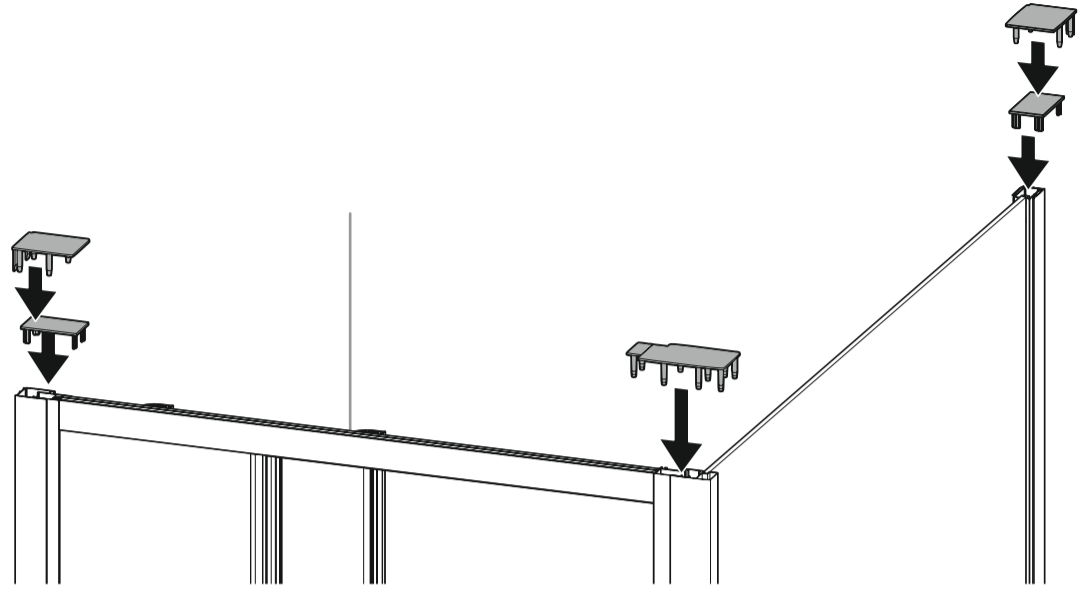

13

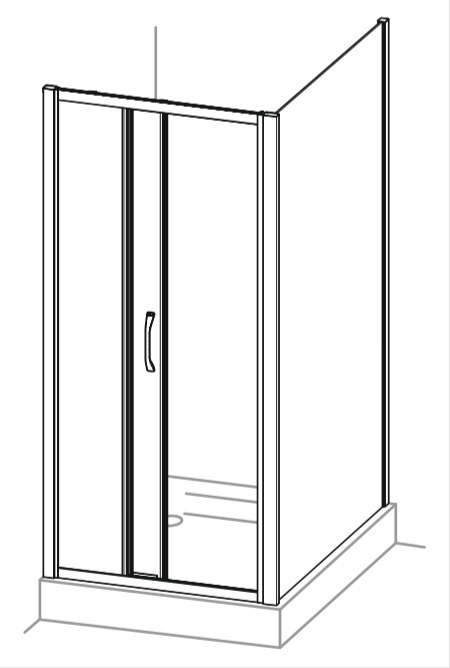
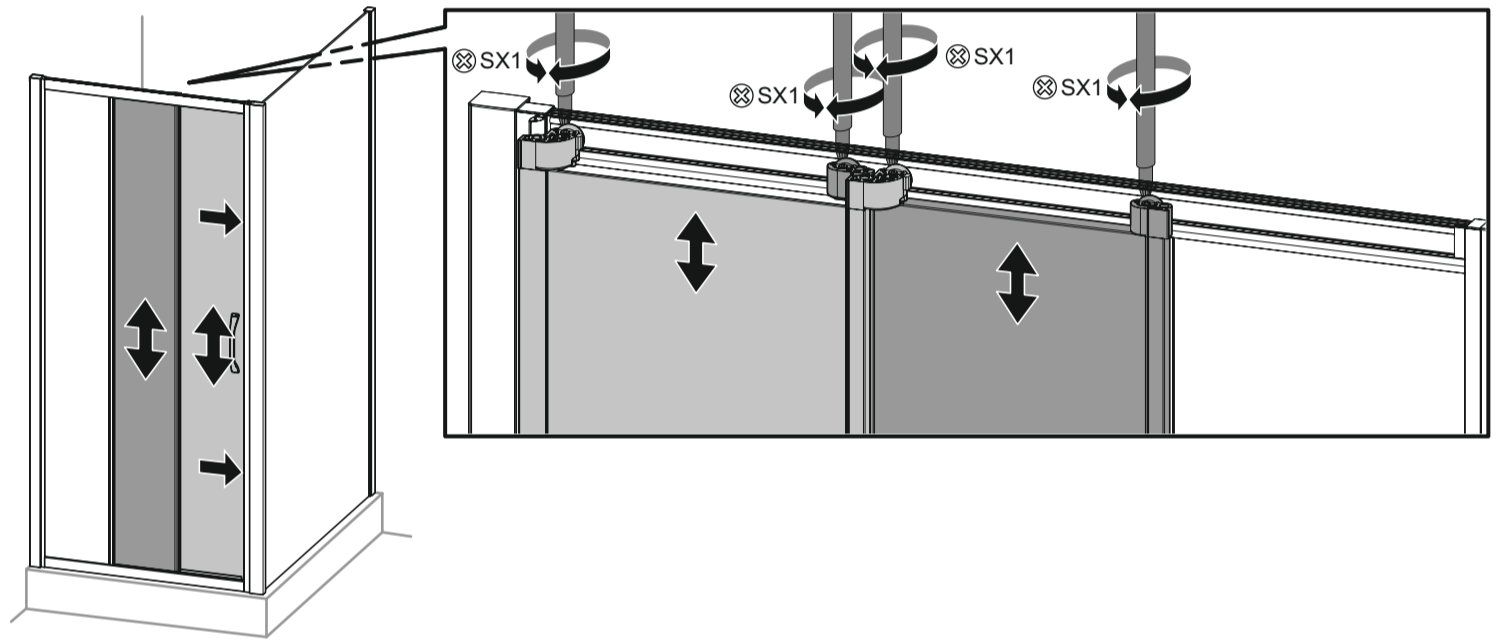

14

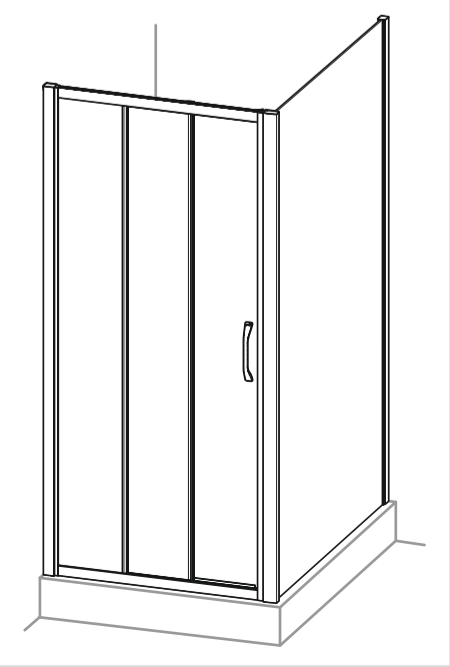
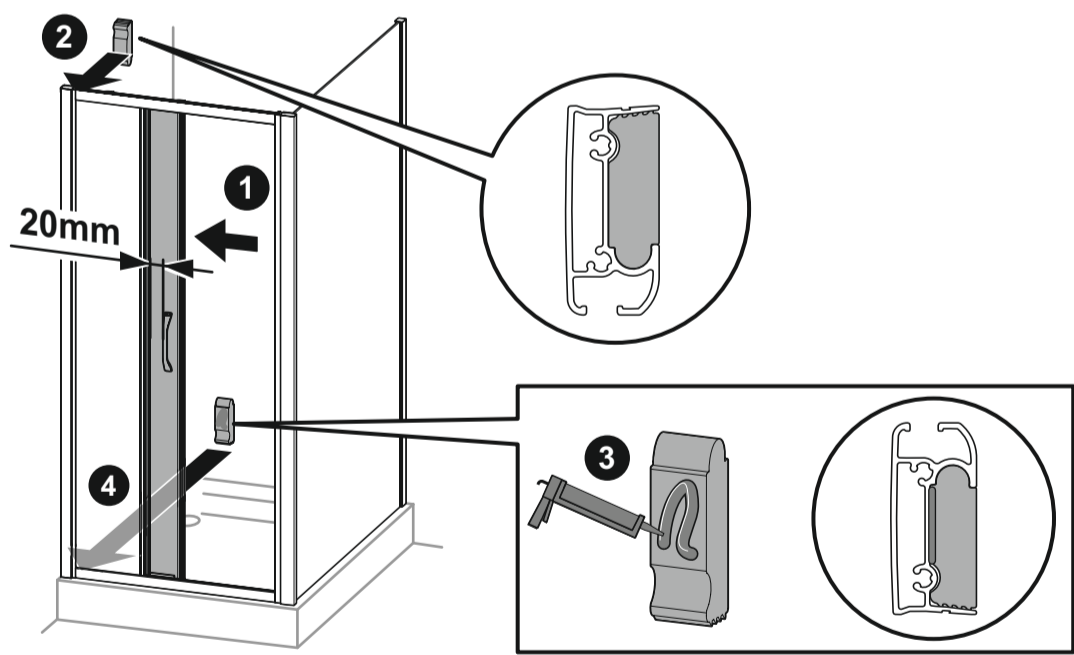

15

