

**Data Sheet | Item Number: 2231-1116/327-047**

1-conductor female connector; lever; Push-in CAGE CLAMP®; 2.5 mm²; Pin spacing 5 mm; 16-pole; direct marking; 2,50 mm²; gray

<https://www.wago.com/2231-1116/327-047>



Color: ■ gray

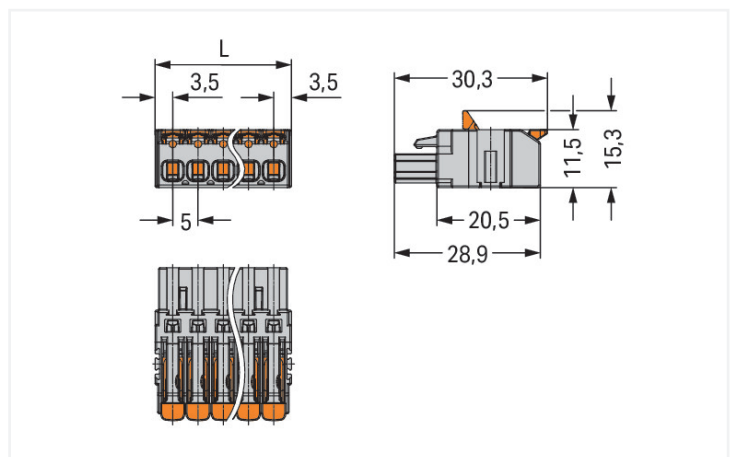
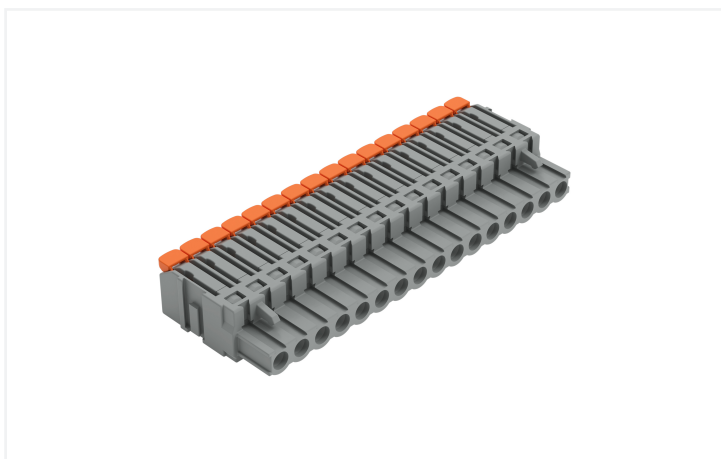

L = (pole no. x pin spacing) + 2 mm2- and 3-pole female connectors – one latch only

- Intuitive and tool-free lever actuation
- Universal connection for all conductor types
- Push-in termination of solid and ferruled conductors
- Just 11.5 mm tall

- Test slot 0° and 90° to conductor entry
- Codable

## Notes

### Safety Information

The MCS – MULTI CONNECTION SYSTEM includes connectors without breaking capacity in accordance with DIN EN 61984. When used as intended, these connectors must not be connected/disconnected when live or under load. When used as intended, these connectors must not be connected/disconnected when live or under load. The circuit design should ensure header pins, which can be touched, are not live when unmated.

### Variants:

Other pole numbers  
Other versions (or variants) can be requested from WAGO Sales or configured at <https://configurator.wago.com/>.

## Electrical data

### Ratings per IEC/EN

Ratings per	IEC/EN 60664-1
Nominal voltage (III/3)	320 V
Rated impulse withstand voltage (III / 3)	4 kV
Rated voltage (III/2)	320 V
Rated impulse withstand voltage (III/2)	4 kV
Nominal voltage (II/2)	630 V
Rated impulse withstand voltage (II/2)	4 kV
Rated current	16 A
Legend (ratings)	(III / 2) $\triangle$ Overvoltage category III / Pollution degree 2

### Ratings per UL

Approvals per	UL 1059
Rated voltage UL (Use Group B)	300 V
Rated current UL (Use Group B)	20 A
Rated voltage UL (Use Group D)	300 V
Rated current UL (Use Group D)	10 A

### Ratings per CSA

Approvals per	CSA
Rated voltage CSA (Use Group B)	300 V
Rated current CSA (Use Group B)	20 A
Rated voltage CSA (Use Group D)	300 V
Rated current CSA (Use Group D)	10 A

## Connection Data

Clamping units	16
Total number of potentials	16
Number of connection types	1
Number of levels	1

### Connection 1

Connection technology	Push-in CAGE CLAMP®
Actuation type	Lever
Solid conductor	0.2 ... 2.5 mm <sup>2</sup> / 24 ... 12 AWG
Fine-stranded conductor	0.2 ... 2.5 mm <sup>2</sup> / 24 ... 12 AWG
Fine-stranded conductor; with insulated ferrule	0.25 ... 1.5 mm <sup>2</sup>
Fine-stranded conductor; with uninsulated ferrule	0.25 ... 2.5 mm <sup>2</sup>
Strip length	11 ... 12 mm / 0.43 ... 0.47 inches
Pole number	16
Conductor entry direction to mating direction	0°

### Physical data

Pin spacing	5 mm / 0.197 inches
Width	52 mm / 3.228 inches
Height	11.5 mm / 0.453 inches
Depth	30.3 mm / 1.193 inches

### Mechanical data

Variable coding	Yes
Anti-rotation protection	Yes

### Plug-in connection

Contact type (pluggable connector)	Female connector/socket
Connector (connection type)	for conductor
Mismating protection	No

### Material data

Note (material data)	<a href="#">Information on material specifications can be found here</a>
Color	gray
Material group	I
Insulation material (main housing)	Polyamide (PA66)
Flammability class per UL94	V0
Clamping spring material	Chrome-nickel spring steel (CrNi)
Contact material	Copper alloy
Contact Plating	Tin
Fire load	0.408 MJ
Actuator color	orange
Weight of insulation material	3.81 g
Weight	26 g

### Environmental requirements

Limit temperature range	-60 ... +100 °C
Processing temperature	-35 ... +60 °C

### Commercial data

PU (SPU)	25 pcs
Packaging type	Box
Country of origin	PL
GTIN	4066966740325
Customs tariff number	85366990990

### Product Classification

ETIM 9.0	EC002638
ETIM 10.0	EC002638
ECCN	NO US CLASSIFICATION

Environmental Product Compliance	
RoHS Compliance Status	Compliant, No Exemption

## Downloads









### Documentation

Additional Information			
Technical Section	03.04.2019	pdf 2027.26 KB	<a href="#">↓</a>

## 1 Compatible Products

### 1.1 System counterpart

#### 1.1.1 Male connector/plug

 <p><b>Item No.: 231-616</b> 1-conductor male connector; CAGE CLAMP®; 2.5 mm²; Pin spacing 5 mm; 16-pole; gray</p>	 <p><b>Item No.: 2231-1616</b> 1-conductor male connector; lever; Push-in CAGE CLAMP®; 2.5 mm²; Pin spacing 5 mm; 16-pole; 2,50 mm²; gray</p>	 <p><b>Item No.: 2231-1616/000-044</b> 1-conductor male connector; lever; Push-in CAGE CLAMP®; 2.5 mm²; Pin spacing 5 mm; 16-pole; direct marking; 2,50 mm²; gray</p>	 <p><b>Item No.: 2231-1616/000-9034</b> 1-conductor male connector; lever; Push-in CAGE CLAMP®; 2.5 mm²; Pin spacing 5 mm; 16-pole; direct marking; 2,50 mm²; gray</p>
 <p><b>Item No.: 2231-1616/336-000</b> 1-conductor male connector; lever; Push-in CAGE CLAMP®; 2.5 mm²; Pin spacing 5 mm; 16-pole; Strain relief plate; 2,50 mm²; gray</p>	 <p><b>Item No.: 231-446/001-000</b> THT male header; 1.0 x 1.0 mm solder pin; angled; Pin spacing 5 mm; 16-pole; gray</p>	 <p><b>Item No.: 231-146/001-000</b> THT male header; 1.0 x 1.0 mm solder pin; straight; Pin spacing 5 mm; 16-pole; gray</p>	 <p><b>Item No.: 231-476/001-000</b> THT male header; 1.2 x 1.2 mm solder pin; angled; Pin spacing 5 mm; 16-pole; gray</p>
 <p><b>Item No.: 231-176/001-000</b> THT male header; 1.2 x 1.2 mm solder pin; straight; Pin spacing 5 mm; 16-pole; gray</p>			

## 1.2 Optional Accessories

### 1.2.1 Coding

#### 1.2.1.1 Coding



**Item No.: 2231-505**  
Coding pin carrier; 5 coding keys; for female connectors; orange

## 1.2.2 Ferrule

### 1.2.2.1 Ferrule



**Item No.: 216-262**

Ferrule; Sleeve for 0.75 mm<sup>2</sup> / 18 AWG; insulated; electro-tin plated; electrolytic copper; gastight crimped; acc. to DIN 46228, Part 4/09.90; gray

**Item No.: 216-263**

Ferrule; Sleeve for 1 mm<sup>2</sup> / AWG 18; insulated; electro-tin plated; electrolytic copper; gastight crimped; acc. to DIN 46228, Part 4/09.90; red

**Item No.: 216-264**

Ferrule; Sleeve for 1.5 mm<sup>2</sup> / AWG 16; insulated; electro-tin plated; electrolytic copper; gastight crimped; acc. to DIN 46228, Part 4/09.90; black

**Item No.: 216-284**

Ferrule; Sleeve for 1.5 mm<sup>2</sup> / AWG 16; insulated; electro-tin plated; electrolytic copper; gastight crimped; acc. to DIN 46228, Part 4/09.90; black

## 1.2.3 Insulation stop

### 1.2.3.1 Insulation stop



**Item No.: 231-671**

Insulation stop; 0.25 - 0.5 mm<sup>2</sup>; light gray

**Item No.: 231-672**

Insulation stop; 0.75 - 1 mm<sup>2</sup>; dark gray

## 1.2.4 Locking system

### 1.2.4.1 Locking system



**Item No.: 2231-515**

center locking; for female connectors; For Push-in CAGE CLAMP® connection; lever; Pin spacing 5 mm; 5-pole; orange

**Item No.: 2231-510**

Locking lever; for female connectors; 1 part; For Push-in CAGE CLAMP® connection; lever; orange

## 1.2.5 Marking

### 1.2.5.1 Marking strip



**Item No.: 210-332/500-202**

Marking strips; as a DIN A4 sheet; MARKED; 1-16 (160x); Height of marker strip: 3 mm; Strip length 182 mm; Horizontal marking; Self-adhesive; white

**Item No.: 210-332/500-205**

Marking strips; as a DIN A4 sheet; MARKED; 1-32 (80x); Height of marker strip: 3 mm; Strip length 182 mm; Horizontal marking; Self-adhesive; white

**Item No.: 210-332/500-204**

Marking strips; as a DIN A4 sheet; MARKED; 17-32 (160x); Height of marker strip: 3 mm; Strip length 182 mm; Horizontal marking; Self-adhesive; white

**Item No.: 210-332/500-206**

Marking strips; as a DIN A4 sheet; MARKED; 33-48 (160x); Height of marker strip: 3 mm; Strip length 182 mm; Horizontal marking; Self-adhesive; white

## 1.2.6 Strain relief

### 1.2.6.1 Strain relief plate



**Item No.: 2231-536**

Strain relief plate; for female and male connectors; 1 part; lever; Pin spacing 5 mm; gray

## 1.2.7 Test and measurement

### 1.2.7.1 Testing accessories



**Item No.: 210-136**

Test plug; 2 mm Ø; with 500 mm cable; red

**Item No.: 231-661**

Test plugs for female connectors; for 5 mm and 5.08 mm pin spacing; 2,50 mm<sup>2</sup>; light gray

## 1.2.8 Tool

### 1.2.8.1 Operating tool



**Item No.: 210-720**

Operating tool; Blade: 3.5 x 0.5 mm; with a partially insulated shaft; multicoloured

**Item No.: 210-657**

Operating tool; Blade: 3.5 x 0.5 mm; with a partially insulated shaft; short; multicoloured

## Installation Notes

### Conductor termination

Inserting solid conductor via push-in termination.

Insert fine-stranded conductors – and remove all conductors – via operating tool.

### Conductor removal

Removing a conductor via lever.

## Testing

Coding

Coding a 1-conductor female connector by inserting a coding pin.