

Acti 9

Ready to install
Distribution and
control products

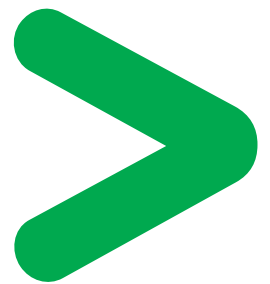

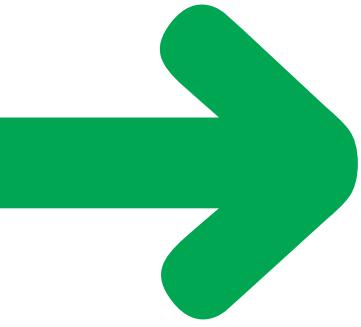

Introduction

Schneider Electric's Ready to Install offer brings together the company's range of solutions for the distribution, protection, control and management of electrical systems. As a global specialist in energy management, Schneider Electric offers integrated solutions making energy safer, more reliable, efficient and productive.

The Ready to Install offer includes a comprehensive range of distribution boards, panel boards, switchgear, protection devices, control and command solutions, metering and measurement products and Integrated Installation Solutions.

Our products are highly compatible and complement each other, allowing you to provide your customers with integrated, tailored solutions. For easy identification, products previously known under the Merlin Gerin and Mita brands are now being labelled as Schneider Electric so customers can spot our quality solutions at a glance.

Whether you're specifying equipment for a major project or buying a selection of components for a simple maintenance installation, our range is unequalled. When you choose a system bearing our name you have the reassurance it is of the highest quality. Wherever you are located and whatever your need, we are committed to meeting your requirements.

The Ready to Install offer now includes our award winning Acti 9 product range, winner of Select's Best New Product category.



Contents

Acti 9 Isobar	Section	1
Acti 9 MCBs, RCCB	Section	2
DIN rail mounted MCBs	Section	3
Surge protection	Section	4
Remote operated earth leakage protection	Section	5
Remote operated MCBs	Section	6
Control and command	Section	7
Powerpact 4 panelboards	Section	8
Wall mounted switchgear	Section	9
Connection systems and enclosures	Section	10
Technical data	Section	11
Dimensions	Section	12



A type distribution board features page 1/2

B type distribution board features page 1/3

A type **pages 1/4 to 1/7**

- Distribution boardspage 1/4
- Multi service distribution boardspage 1/4
- Split load distribution boardspage 1/4
- Connectionspage 1/5
- Split metered distribution boardspage 1/5
- Incomerspage 1/6
- Accessoriespage 1/7

B type **pages 1/8 to 1/13**

- Standard distribution boardspage 1/8
- Meter ready distribution boardspage 1/8
- Split metered distribution boardspage 1/8
- Metering kitspage 1/10
- Connectionspage 1/10
- Standard IP55 distribution boardspage 1/11
- Incomerspage 1/12
- Top or bottom extension enclosurespage 1/13
- Side extension enclosurespage 1/13
- Accessoriespage 1/13

Replacement items **pages 1/14 to 1/15**

- Pan assemblies, Type A and Type Bpage 1/14
- Doors and covers, Type A and Type Bpage 1/14
- Pan assemblies - accessoriespage 1/15

Acti 9 Isobar A type single phase distribution boards

1

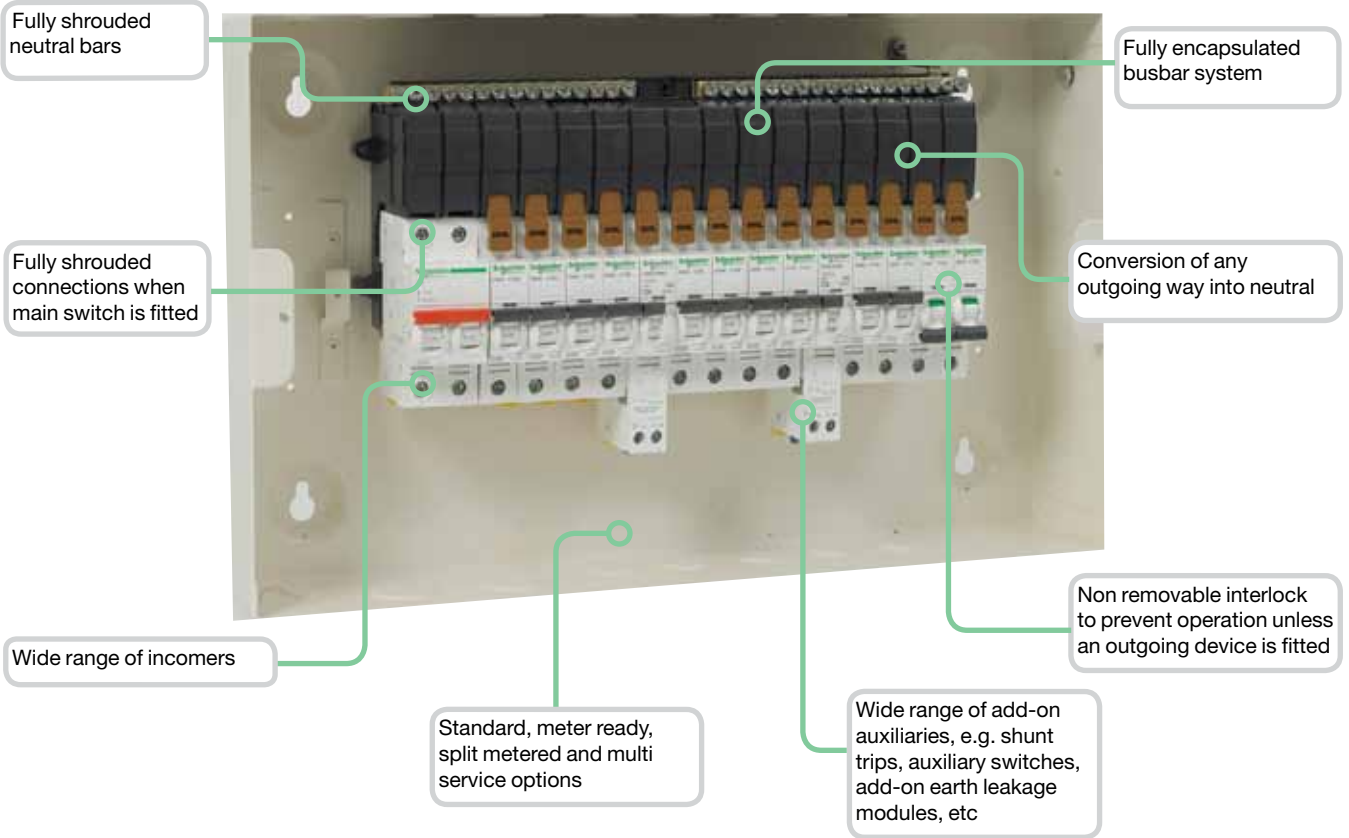

- Fully type tested conditional short circuit rating of 16kA to BS EN 61439-3
- High performance MCB 10kA BS EN 60898 15kA BS EN 60947-2 in B, C or D curve single and double pole
- 125A busbar rating
- Isobar disconnection to BS EN 60947-3 ensuring unused outgoing ways are isolated
- Option of switching outgoing neutral on all boards using distributed neutral kit
- Terminal block for feeding up to 100A
- Range of incomers: switch disconnectors, residual current devices, terminal blocks
- Single pole RCBO for new or retrofit maintaining device density
- Full range of device accessories and auxiliaries
- Knockouts for cable gland and conduit mixed to suit the installation needs without loss of space
- Split metering options

Acti 9 Isobar B type 3 phase distribution boards

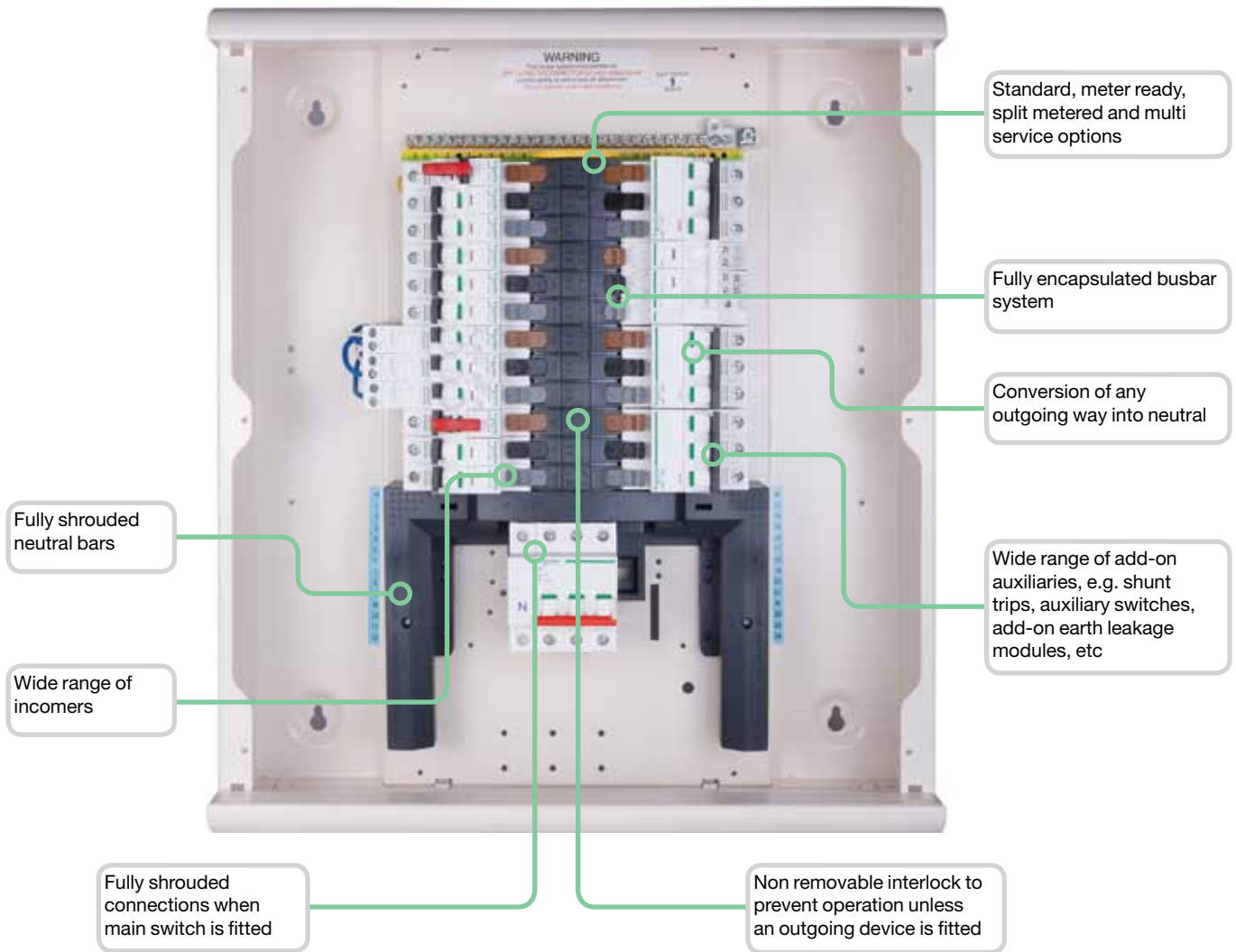

- Fully type tested conditional short circuit rating of 25kA to BS EN 61439-3
- High performance MCB 10kA BS EN 60898 15kA BS EN 60947-2 in B, C or D curve 1, 2, 3, 4 pole
- 250A busbar rating
- Isobar disconnection to BS EN 60947-3 ensuring unused outgoing ways are isolated
- Option of switching outgoing neutral on all boards using distributed neutral kit
- Terminal block for feeding up to 100A
- Range of incomers: switch disconnectors, residual current devices, terminal blocks, mccb
- Single pole RCBO for new or retrofit maintaining device density
- Full range of device accessories and auxiliaries
- Knockouts for cable gland and conduit mixed to suit the installation needs without loss of space
- Removable insulated pan assembly
- Fully shrouded neutral
- Split neutral bars
- Removable gland plates
- Optional metering, dual supply, surge protection and contactor on incoming
- Metered extension enclosures

Acti 9 Isobar A type distribution boards

1

BS EN 61439-3
IEC 61439-3

- Acti 9 Isobar is a complete range of single and 3 phase distribution boards for commercial and industrial applications
- Standard distribution boards up to 24 ways
- Multi service distribution boards up to 24 ways
- Dual incomer distribution boards up to 24 ways
- Split load distribution boards up to 24 ways
- Split metered distribution boards up to 20 ways
- Any outgoing way can be converted to switch the Neutral



Alternating current (AC) 50Hz		
withstand	110v	230/240v
conditional	25kA	25kA
unconditional	25kA/50mS	25kA/50mS
	17kA/200mS	17kA/200mS
Direct current (DC)		
	24v	48v
unconditional	25kA/50mS	25kA/50mS

Catalogue numbers

Acti 9 Isobar Standard distribution boards busbar rating 125 amp		
Incomers not included	No of SP ways	No of DP ways*
SEA9AN2	2	1
SEA9AN6	6	3
SEA9AN10	10	5
SEA9AN14	14	7
SEA9AN18	18	9
SEA9AN27	27	12

*When used with distributed neutral



Acti 9 Isobar Multi service distribution boards busbar rating 125 amp		
Incomers not included	No of SP ways	Useable DIN rail 18mm ways
SEA9AN108MS	10	4
SEA9AN1432MS	14	16
SEA9AN616MS	6	8
SEA9AN624MS	6	12
SEA9AN148MS	14	4
SEA9AN1016MS	10	8

Acti 9 Isobar Split load distribution boards busbar rating 125 amp		
Incomers not included	Unprotected way	RCCB protected ways
SEA9AN96SL	9	6
SEA9AN510SL	5	10
SEA9AN56SL	5	6

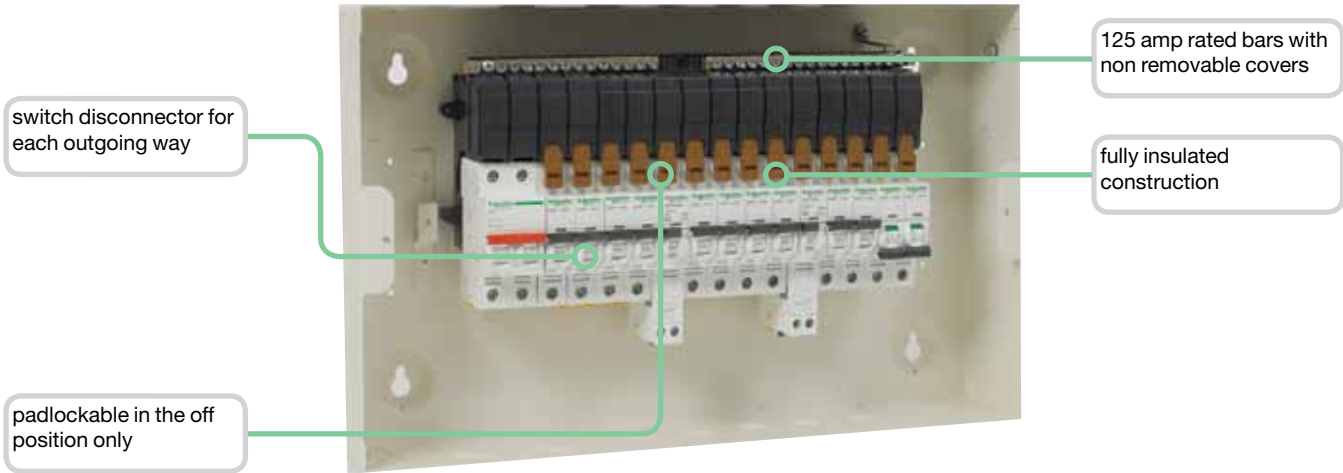

Technical data Standard, Meter ready, Split metered Acti 9 Isobar

Main characteristics		110v	230/240v	
According to BE EN 61439-3				
Withstand	conditional	25kA	25kA	
	unconditional	25kA/50mS	25kA/50mS	
		17kA/200mS	17kA/200mS	
insulation voltage (Ui)		500V	500V	
Pollution degree		3	3	
Rated impulse withstand voltage (Uimp)		6kV	6kV	
Current rating (A)	direct connection	125A	Terminal block 125A	
	Switch disconnecter	125A	Power switch 125A	
	RCCB sensitivities (mA)	30, 100, 300, 300TD, 100A		
Degree of protection (IEC 60529)		External IP3X Internal IP20		
Endurance (O-C) Isobar switch disconnecter		3000		
Overvoltage category		IV		
Operating temperature		-35 to +70°C		
Storage teperature		-40 to +80°C		
Connections				
Rating	Tightening torque	Copper lugs	Cables bare	Device
125 amp		■	50mm	DIN switch disconnector
125 amp		■	50mm	Terminal block
100 amp		■	35mm	RCCB



Acti 9 Isobar Dual supply distribution boards busbar rating 125 amp

Incomers not included	Section 1 SP ways	Section 2 SP ways
SEA9AN106DS	10	6
SEA9AN26DS	2	6
SEA9AN66DS	6	6

Acti 9 Isobar Split metered distribution boards busbar rating 100 amp direct connected meters

Incoming switch disconnector included	Meter type	No of SP ways	No of SP ways
SEA9AN6S6	40A direct connected	6	6
SEA9AN10S10	63A direct connected	10	10
SEA9AN14S14	63A direct connected	14	14
Total load	2 row 50A per row 1 row 40A per split	Meter used	A9M17067 A9MEM2010

1

Weight (kG) - Dimensions (mm)								
Standard	Multi service	Split load	Dual Incomer	Split metered	kG	Height	Width	Depth
2 way	■	■	■	■	1.8	300	200	117
6 way	■	■	■	■	2.5	300	273	117
10 way	■	■	2 - 6	■	3.0	300	345	117
14 way	6 - 16, 10 - 8	5 - 6	6 - 6	■	4.8	300	417	117
18 way	6 - 24, 10 - 16, 14 - 8	5 - 10, 9 - 6	10 - 6	6 - 6	5.7	300	489	117
27 way	14 - 32	10 - 10, 14 - 14	■	10 - 10	8.9	530	417	117



Incomers			
Switch disconnecter		Rating (A)	No of poles
SEA9R1252		125	2
Residual current circuit breaker 230/240vAC		Rating (A)	No of poles
Sensitivity (mA)			
SEA9R41263	30	63	2
SEA9R12263	100	63	2
SEA9R44263	300	63	2
SEA9R11280	30	80	2
SEA9R12280	100	80	2
SEA9R14280	300	80	2
SEA9R15280	300 TD	80	2
SEA9R11291	30	100	2
SEA9R12291	100	100	2
SEA9R14291	300	100	2
SEA9R15291	300 TD	100	2
Terminal block		Rating (A)	No of poles
SEA9TB1252		125	2

DIN rail only enclosures			
Reference	Description	Number of rows	Dimensions as
SEA9DE16	8 SP way module enclosure	1	SEA9AN6
SEA9DE24	12 SP way module enclosure	1	SEA9AN10
SEA9DE32	16 SP way module enclosure	1	SEA9AN14
SEA9DE40	20 SP way module enclosure	1	SEA9AN18
SEA9DE64	32 SP way module enclosure	2	SEA9AN27



Accessories

Flush mounting kits (overall dimensions add 50mm to width and height)		
Reference		No of ways
SEA9AN6FK	Flush mounting kit	6
SEA9AN10FK	Flush mounting kit	10
SEA9AN14FK	Flush mounting kit	14
SEA9AN18FK	Flush mounting kit	18
Distributed neutral kits		
Reference		No of ways
SEA9NA6	Distributed neutral for 6 way SP+N	6
SEA9NA10	Distributed neutral for 10 way SP+N	10
SEA9NA14	Distributed neutral for 14 way SP+N	14
SEA9NA18	Distributed neutral for 18 way SP+N	18
SEA9NA27	Distributed neutral for 27 way SP+N	27
SEA9NKIT	Phase to neutral conversion kit (pack 4)	
Reference	Description	
SEA9BL	Door lock	
SEA9PD	Padlock kit for door	
SEA9BP	Blank pole	
SEA9BP25	Pack of 25 x 5 pole filler	
SEA9BP5	single 5 pole filler	
SEA9TB1001	100 amp terminal block 1 pole	
SEA9ANWL	SP&N LABELS	

Acti 9 Isobar A type pan assemblies					
Reference		No of ways	Height	Width	Depth
SEA9AN6PS	Supplied without distributed neutral	6	202	200	87
SEA9AN10PS	Supplied without distributed neutral	10	202	272	87
SEA9AN14PS	Supplied without distributed neutral	14	202	344	87
SEA9AN18PS	Supplied without distributed neutral	18	202	416	87



Doors and covers	
Reference	
SEA9AN6C	6 way door and cover
SEA9AN10C	10 way door and cover
SEA9AN14C	14 way door and cover
SEA9AN18C	18 way door and cover
SEA9AN27C	27 way door and cover

Acti 9 Isobar B type distribution boards

1



BS EN 61439-3 IEC 61439-3

- Acti 9 Isobar is a complete range of single and 3 phase
- distribution boards for commercial and industrial
- applications
- Standard distribution boards up to 24 ways
- Meter ready distribution boards up to 24 ways
- Split metered distribution boards up to 22 ways
- Any outgoing way can be converted to switch the Neutral

Alternating current (AC) 50Hz			
withstand	230/240v	400v	415v
conditional	25kA	25kA	25kA
unconditional	25kA/50mS	25kA/50mS	25kA/50mS
	17kA/200mS	17kA/200mS	17kA/200mS

Direct current (DC)			
	24v	48v	
unconditional	25kA/50mS	25kA/50mS	

Catalogue numbers

Acti 9 Isobar Standard distribution boards busbar rating 250 amp			
	No of TP ways	No of SP ways	No of DP ways*
SEA9BN4	4	12	6
SEA9BN6	6	18	9
SEA9BN8	8	24	12
SEA9BN12	12	36	18
SEA9BN16	16	48	24
SEA9BN18	18	54	26
SEA9BN24	24	72	36

Acti 9 Isobar Meter ready distribution boards busbar rating 250 amp			
	No of TP ways	No of SP ways	No of DP ways
SEA9BN6M	6	18	9
SEA9BN8M	8	24	12
SEA9BN12M	12	36	18
SEA9BN16M	16	48	24
SEA9BN18M	18	54	26
SEA9BN24M	24	72	36

*Metering kits page 1/10

Acti 9 Isobar Split metered* distribution boards busbar rating 125 amp switch disconnecter fitted

	Lower pan assembly No of TP ways	No of SP ways	Upper pan assembly No of TP ways	No of SP ways
SEA9BN1256S8	8	24	8	24
SEA9BN12512S8	14	42	8	24
SEA9BN12514S6	16	48	6	18
SEA9BN12516S4	18	54	4	12

Acti 9 Isobar Split metered* distribution boards busbar rating 250 amp - incomer supplied separately

	Lower pan assembly No of TP ways	No of SP ways	Upper pan assembly No of TP ways	No of SP ways
SEA9BN2506S8	8	24	8	24
SEA9BN25012S8	14	42	8	24
SEA9BN25014S6	16	48	6	18
SEA9BN25016S4	18	54	4	12

*MID 3 Phase kWh kit Modbus communications and pulsed output

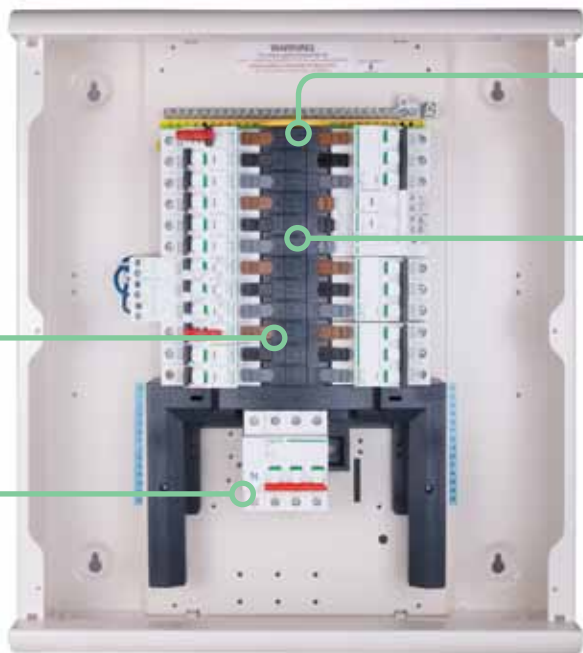

250 amp rated bars with non removable covers

fully insulated construction

interlocked switch disconnecter for each outgoing way

padlockable in the off position only

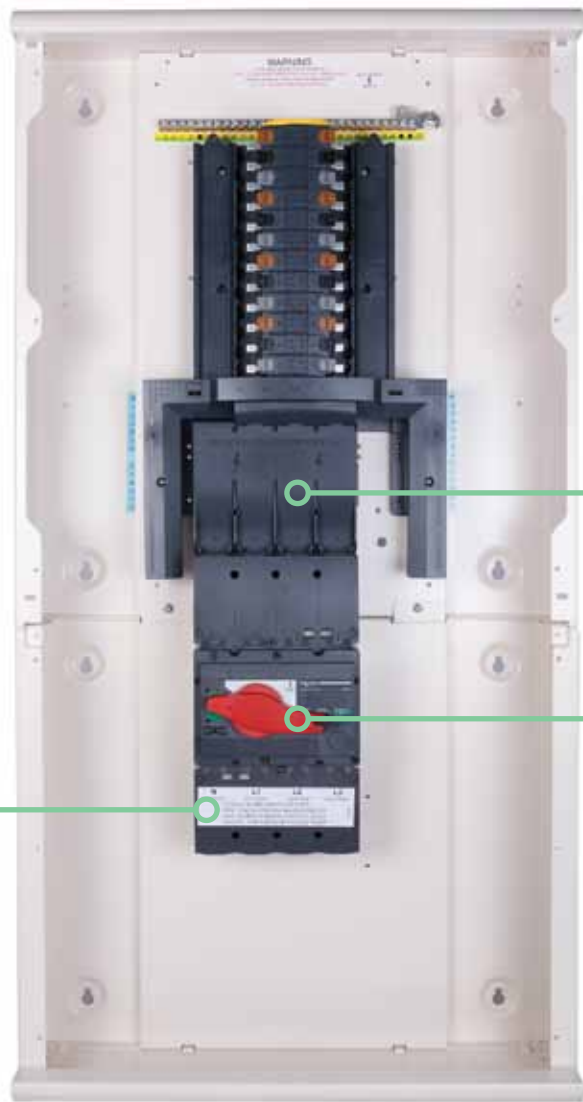

fully shrouded connections

padlockable handle

voltage test points

1

Metering kits				
Acti 9 Standard distribution boards			Rating (A)	Connection
SEA9BNKWH	MID 3 Phase kWh kit Modbus communications and pulsed output	Height 270 (mm)	250	via CT
SEA9BNKWHP	MID 3 Phase kWh kit pulsed output	Height 270 (mm)	250	via CT
SEA9BNMETE	Metering enclosure for standard Acti 9 Isobar boards for PM meters	height 270 (mm)	250	via CT
Acti 9 Meter ready distribution boards			Rating (A)	Connection
SEA9BN3155	MID 3 Phase kWh kit Modbus communications	Integral	63	direct
SEA9BN3110	MID 3 Phase kWh kit pulsed output	Integral	63	direct
SEA9BN3255	MID 3 Phase kWh kit Modbus communications	Height 135 (mm)	125	via CT
SEA9BN3210	MID 3 Phase kWh kit pulsed output	Height 135 (mm)	125	via CT

Incomers for 250 amp split metered boards			
		Rating (A)	No. of poles
SEA9NCB1604SM	160A 4P MCCB for A9 split meter board	160	4
SEA9NCB2004SM	200A 4P MCCB for A9 split meter board	200	4
SEA9NCB2504SM	250A 4P MCCB for A9 split meter board	250	4
SEA9NI1604SM	160A 4P Switch for A9 split meter board	160	4
SEA9NI2004SM	200A 4P Switch for A9 split meter board	200	4
SEA9NI2504SM	250A 4P Switch for A9 split meter board	250	4

Connections

Rating	Copper lugs	Bare cables	Device
125 amp		50mm	DIN switch disconnecter/Terminal block
		95mm with spreader connection	Interpact DIN Switch Disconnecter
160 -250 amp	95mm	185mm with cable clamps	Interpact Switch Disconnecter
	95mm	185mm with cable clamps	NSX Moulded case circuit breaker
	120 mm		Terminal block

Technical data Standard, Meter ready, Split metered Acti 9 Isobar

Main characteristics		230/240v	400v	415v
Withstand	conditional	25kA	25kA	25kA
	unconditional	25kA/50mS	25kA/50mS	25kA/50mS
		17kA/200mS	17kA/200mS	17kA/200mS
Insulation voltage (Ui)		500vAC	500vAC	500vAC
Pollution degree		3	3	3
Rated impulse withstand voltage (Uimp)		6kV	6kV	6kV
Current rating (A)	direct connection	125/250	6kV	6kV
	Switch disconnecter	125	DIN mounted Power switch	
		160-200-250	Interpact	
MCCB	100-160-200-225-250			
Degree of protection (IEC 60529)		External IP3X or IP55 Internal IP20		
Endurance (O-C) Isobar switch disconnecter		3000		
Overvoltage category		IV		
Operating temperature		-35 to +70°C		
Storage teperature		-40 to +80°C		

SEA9BN6HDGK



Main characteristics Acti 9 Isobar Heavy Duty

According to BE EN 61439-3		230/240v	400v	415v
Withstand	conditional	25kA	25kA	25kA
	unconditional	25kA/50mS	25kA/50mS	25kA/50mS
		17kA/200mS	17kA/200mS	17kA/200mS
Insulation voltage (Ui)		500vAC		
Pollution degree		3		
Rated impulse withstand voltage (Uimp)		6kV		
Current rating (A)		125A		
Degree of protection (IEC 60529)		External IP55 Internal IP20		
Endurance (O-C) Isobar switch disconnecter		3000		
Overvoltage category		IV		
Operating temperature		-35 to +70°C		
Storage teperature		-40 to +80°C		

Anti condensation measures should be taken if installed in an external location

Catalogue numbers

Acti 9 Isobar Standard IP55 distribution boards busbar rating 125 amp steel door

	No of TP ways	No of SP ways	No of DP ways
SEA9BN6HDGR	6	18	9
SEA9BN8HDGR	8	24	12
SEA9BN12HDGR	12	36	18
SEA9BN16HDGR	16	48	24

Acti 9 Isobar Standard IP55 distribution boards busbar rating 125 amp transparent door

	No of TP ways	No of SP ways	No of DP ways
SEA9BN6HDGK	6	18	9
SEA9BN8HDGK	8	24	12
SEA9BN12HDGK	12	36	18
SEA9BN16HDGK	16	48	24

Acti 9 Isobar and Acti 9 Isobar IP55

Weight (kG) - Dimensions (mm)

Standard	Meter ready	Split meter	kG	Height	Width	Depth
4 way	■	■	9	484	470	139
6 way	6 way	■	10.5	484	470	138
8 way	6 way	■	11	538	470	138
12 way	12 way	■	13.5	700	470	139
16 way	16 way	■	16	808	470	139
18 way	18 way	■	16.2	862	470	139
24 way	24 way	■	22	1024	470	139
■	■	125 amp	28	1290	470	139
■	■	250 amp	32	1694	470	139
250 amp incoming section		■	4	405	470	130

IP55			kG	Height	Width	Depth
6 way		■	32.4	650	600	330
8 way		■	32.9	650	600	330
12 way		■	40.1	800	600	330
16 way		■	41.4	800	600	330

1

SEA91253N



SEA9NI2504



SEA9R14463



SEA9TB1254



SEA9BNDM250SD



Int= Internal to the distribution board
Ext = in 400mm high extension enclosures
■ = not applicable

Incomers							
Switch disconnecter	Rating (A)	No of poles	Standard	Meter ready	Split Metered	IP55	
SEA91253N	125	3P+N	Int	Int	Int	Int	
SEA91254	125	4	Int	Int	Int	Int	
SEA9NI1603	160	3P+N	Ext	Ext	Ext	■	
SEA9NI1604	160	4	Ext	Ext	Ext	■	
SEA9NI2003	200	3P+N	Ext	Ext	Ext	■	
SEA9NI2004	200	4	Ext	Ext	Ext	■	
SEA9NI2254	225	4	Ext	Ext	Ext	■	
SEA9NI2503	250	3P+N	Ext	Ext	Ext	■	
SEA9NI2504	250	4	Ext	Ext	Ext	n ■	
Moulded Case Circuit Breaker	Rating (A)	No of poles	Standard	Meter ready	Split metered	IP55	
SEA9NCB1004	70-100	4	Ext	Ext	Ext	■	
SEA9NCB1604	112-160	4	Ext	Ext	Ext	■	
SEA9NCB2004	140-200	4	Ext	Ext	Ext	■	
SEA9NCB2504	175-250	4	Ext	Ext	Ext	■	
Residual current circuit breaker sensitivity (mA)	Rating (A)	No of poles	Standard	Meter ready	Split metered	IP55	
A9R41463	30	63	4	Int	Int	Int	
A9R12463	100	63	4	Int	Int	Int	
A9R44463	300	63	4	Int	Int	Int	
A9R15463	300/time delayed	63	4	Int	Int	Int	
A9R11480	30	80	4	Int	Int	Int	
A9R14491	300	100	4	Int	Int	Int	
A9R15491	300/time delayed	100	4	Int	Int	Int	
SEA9NI160RCCB	adjustable	160	■	Ext	Ext	Ext	
Terminals for direct connection	Rating (A)	No of poles	Standard	Meter ready	Split metered	IP55	
SEA9TB1254	125	4	Int	Int	Int	Int	
SEA9NTB2504	250	4	Ext	Ext	Ext	■	
Dual source incomer	Rating (A)	No of poles	Standard	Meter ready	Split metered	IP55	
SEA9NDSI	*270mm enclosure	125	4	Ext	Ext	Ext	
Contactormeter incomer	Rating (A)	No of poles	Standard	Meter ready	Split metered	IP55	
SEA9BN100CCI	*270mm enclosure	100	4	Ext	Ext	Ext	
Dual metered extension enclosure MID 3 Phase kWh kit Modbus communications and pulsed output 270mm enclosures	Rating (A)	No of poles	Standard	Meter ready	Split metered	IP55	
SEA9BNDM160SD	Interpact SD	160	4	Ext 270mm	■	■	
SEA9BNDM200SD	Interpact SD	200	4	Ext 270mm	■	■	
SEA9BNDM250SD	Interpact SD	250	4	Ext 270mm	■	■	
SEA9BNDM160M	NSX MCCB	160	4	Ext 270mm	■	■	
SEA9BNDM200M	NSX MCCB	200	4	Ext 270mm	■	■	
SEA9BNDM250M	NSX MCCB	250	4	Ext 270mm	■	■	
Single phasing kits	Rating (A)	No of poles	Standard	Meter ready	Split metered	IP55	
SEA9125SPEV	125	4	Int	Int	Int	Int	
SEA9250SPEV	250	4	Int	Int	Int	■	

SEA9BNEX034N



Top or bottom extension enclosures height 270 (mm)		■ not applicable		
Switch disconnecter	Description			
SEA9BNEXN	Plain front cover for additional wiring space			
SEA9BNEX034N	Mounting of DIN devices, overall door and cutout for 17 x 18mm poles			
SEA9BNEXA14N	Single phase add on distribution board 14 way			

SEA9BN8SXS



Side extension enclosures				
Reference	Description	No of rows	Total 18mm SP ways	Dimensions as
SEA9BN4SXS	Slotted front cover + overall door	2	34	SEA9BN4
SEA9BN8SXS	Slotted front cover + overall door	2	34	SEA9BN8
SEA9BN12SXS	Slotted front cover + overall door	3	51	SEA9BN12
SEA9BN16SXS	Slotted front cover + overall door	4	68	SEA9BN16
SEA9BN24SXS	Slotted front cover + overall door	5	85	SEA9BN24
SEA9BN4SXP	Plain front cover + overall door	2	34	SEA9BN4
SEA9BN8SXP	Plain front cover + overall door	2	34	SEA9BN8
SEA9BN12SXP	Plain front cover + overall door	3	51	SEA9BN12
SEA9BN16SXP	Plain front cover + overall door	4	68	SEA9BN16
SEA9BN24SXP	Plain front cover + overall door	5	85	SEA9BN24

SEA9BN8SXP



SEA9NEK2



Accessories	
Reference	Description
SEA9BL	Door lock
SEA9PD	Padlock kit for door
SEA9NEK1	Extra earth terminal bar 14 hole
SEA9NEK2	Extra earth terminal bar 20 hole
SEA9NEK3	Extra earth terminal bar 26 hole
SEA9LA	Pack of 3 padlock attachment MCB
SEA9BN63SPL	Split load kit 63 amp
SEA9BNSJKN	Side joining kit
SEA9BNTJKA	Top/bottom joining kit for enc/ext/enc
SEA9BNTJKB	Top bottom kit replacing gland plate
SEA9BNTJKN	Joining kit B board top/bottom
SEA9BP	Blank pole
SEA9BP25	Pack of 25 x 5 pole filler
SEA9BP5	Single 5 pole filler
SEA9TB1001	100 amp terminal block 1 pole
SEA9BNBCE25	Clean earth B boards 25 hole
SEA9BNWL	TP&N Labels
SEA9BNC	Neutral shroud (spare)
SEA9NB4	Distributed neutral for 4 way TP+N
SEA9NB6	Distributed neutral for 6 way TP+N
SEA9NB8	Distributed neutral for 8 way TP+N
SEA9NB12	Distributed neutral for 12 way TP+N
SEA9NB16	Distributed neutral for 16 way TP+N
SEA9NB18	Distributed neutral for 18 way TP+N
SEA9NB24	Distributed neutral for 24 way TP+N
SEA9NKIT	Phase to neutral conversion kit (pack 4)
SEA9ISOKEY	Pack of 5 disconnecter keys
SEA9BGPEXN	Gland plate for Acti9 Isobar 4 extension
SEA9FCF	Pack of 10 cover fixing screws

SEA9BT1001



SEA9NKIT



1

SEA9BN4PS



SEA9BN6P



SEA9BN8E



SEA9BN6TN



Pan assemblies - 3 phase without distributed neutral, supplied without mounting plate

Reference	Description
SEA9BN4PS	Pan assembly 4 way TP&N
SEA9BN6PS	Pan assembly 6 way TP&N
SEA9BN8PS	Pan assembly 8 way TP&N
SEA9BN12PS	Pan assembly 12 way TP&N
SEA9BN16PS	Pan assembly 16 way TP&N
SEA9BN18PS	Pan assembly 18 way TP&N
SEA9BN24PS	Pan assembly 24 way TP&N

Pan assemblies - replacement for Acti 9 Isobar and Isobar 4c distribution boards

Reference	Description
SEA9BN4P	B board replacement pan assembly
SEA9BN6P	B board replacement pan assembly
SEA9BN8P	B board replacement pan assembly
SEA9BN12P	B board replacement pan assembly
SEA9BN16P	B board replacement pan assembly
SEA9BN18P	B board replacement pan assembly
SEA9BN24P	B board replacement pan assembly

Pan assemblies - for switchboard mounting supplied with earths and neutral, phase coloured Isobar switch disconnectors

Reference	Description
SEA9BN4E	Pan assembly 4 way TP+ earth and neutral
SEA9BN6E	Pan assembly 6 way TP+ earth and neutral
SEA9BN8E	Pan assembly 8 way TP+ earth and neutral
SEA9BN12E	Pan assembly 12 way TP+ earth and neutral
SEA9BN16E	Pan assembly 16 way TP+ earth and neutral
SEA9BN18E	Pan assembly 18 way TP+ earth and neutral
SEA9BN24E	Pan assembly 24 way TP+ earth and neutral

Pan assemblies - for switchboard mounting supplied with earths and neutral, black Isobar switch disconnectors

Reference	Description
SEA9BN4PEV	Pan assembly 4 way TP+ earth and neutral
SEA9BN6PEV	Pan assembly 6 way TP+ earth and neutral
SEA9BN8PEV	Pan assembly 8 way TP+ earth and neutral
SEA9BN12PEV	Pan assembly 12 way TP+ earth and neutral
SEA9BN16PEV	Pan assembly 16 way TP+ earth and neutral
SEA9BN18PEV	Pan assembly 18 way TP+ earth and neutral
SEA9BN24PEV	Pan assembly 24 way TP+ earth and neutral

Pan assemblies - 3 phase without distributed neutral, supplied fitted on a mounting plate

Reference	Description
SEA9BN4TN	4 TP&N way panel fixing pan assembly
SEA9BN6TN	6 TP&N way panel fixing pan assembly
SEA9BN8TN	8 TP&N way panel fixing pan assembly
SEA9BN12TN	12 TP&N way panel fixing pan assembly
SEA9BN16TN	16 TP&N way panel fixing pan assembly
SEA9BN18TN	18 TP&N way panel fixing pan assembly
SEA9BN24TN	24 TP&N way panel fixing pan assembly

Door and cover assemblies

Reference	Description
SEA9BN4C	4 way door and cover
SEA9BN6C	6 way door and cover
SEA9BN8C	8 way door and cover
SEA9BN12C	12 way door and cover
SEA9BN16C	16 way door and cover
SEA9BN18C	18 way door and cover
SEA9BN24C	24 way door and cover

SEA9BINCKIT



Pan assemblies - accessories

Reference	Description
SEA9NPB250TB	250 amp incoming terminal block for E/PEV
SEA9BINCKIT	MCCB/Interpact connection kit for use with SEA9NPB250TB
SEA9TB2253	225 amp terminal block for PS/TN

1

Dimensions (mm)

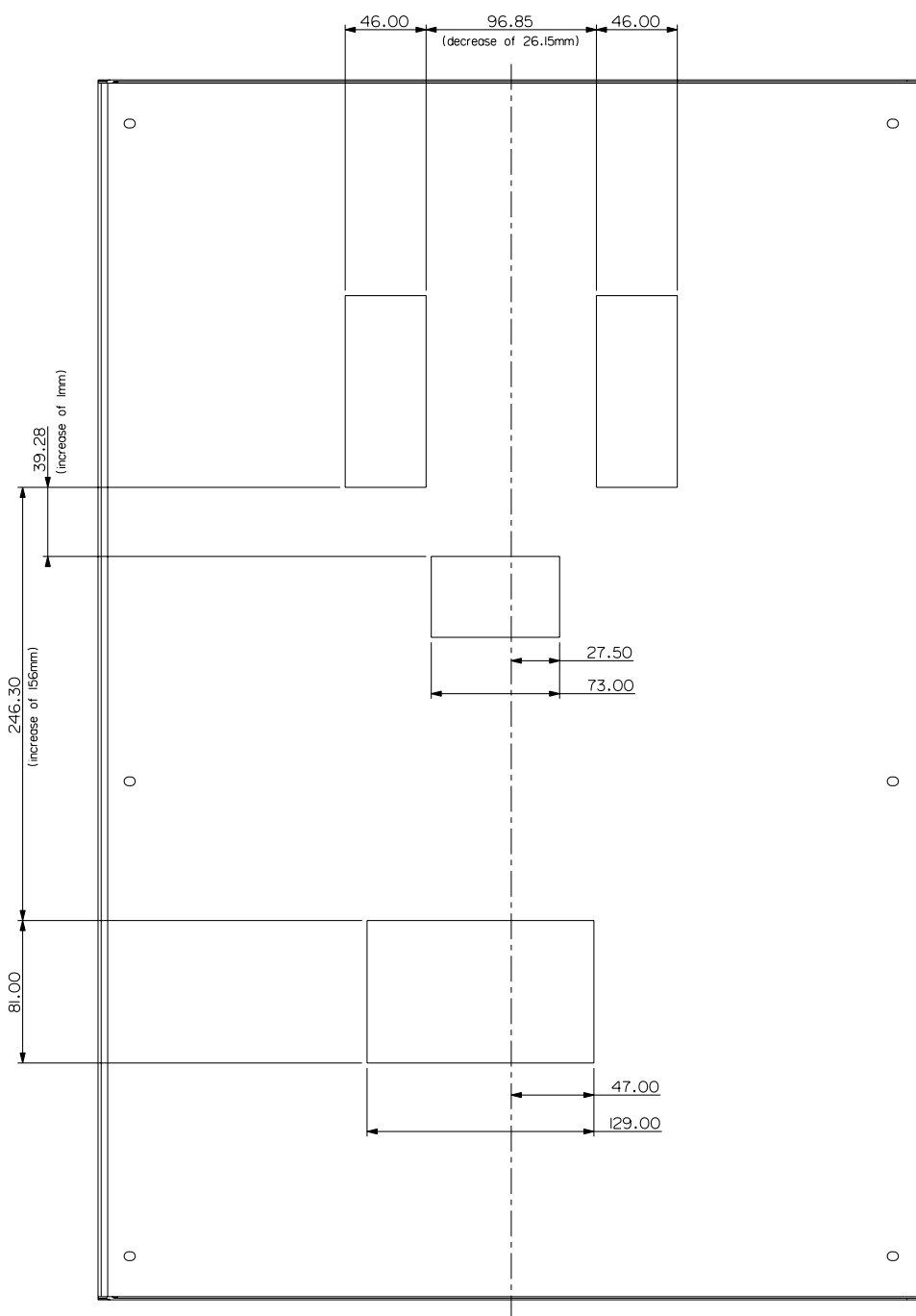

<i>iC60H circuit breakers (curve B, C, D)</i>	<i>pages 2/2 to 2/4</i>
<i>iC60H and iC60H2 RCB0 10, 30 and 100 mA</i>	<i>pages 2/5 to 2/8</i>
<i>Vigi iC60 add-on residual current devices</i>	<i>pages 2/9 to 2/12</i>
A type	pages 2/9 to 2/10
SI type	page 2/11
AC type	page 2/12
<i>iID residual current circuit breakers</i>	<i>pages 2/13 to 2/16</i>
A type	page 2/13
SI type	page 2/14
AC, A, SI type	pages 2/15 to 2/16
<i>Electrical auxiliaries for iC60, iID, iDPN Vigi, RCA and ARA</i> . . .	<i>pages 2/17 to 2/23</i>
<i>Accessories for iC60, iID, iDPN Vigi, Reflex iC60, RCA ARA and iSW</i>	<i>pages 2/24 to 2/29</i>





BS/EN 60947-2 BS/EN 60898-1

- iC60H circuit breakers are multi-standard circuit breakers which combine the following functions:
 - circuit protection against short-circuit currents,
 - circuit protection against overload currents,
 - suitable for industrial isolation according to IEC/EN 60947-2, standard.
 - fault tripping indication by a red mechanical indicator in circuit breaker front face.

Alternating current (AC) 50/60 Hz

Breaking capacity (Icu) according to IEC/EN 60947-2						Service breaking capacity (Ics)
Ph/Ph (2P, 3P, 4P)	Voltage (Ue)					
	12 to 133 V	220 to 240 V	380 to 415 V	440 V		
Ph/N (1P)	12 to 60 V	100 to 133 V	220 to 240 V	-		
Rating (In)	1 to 4 A	70 kA	70 kA	70 kA	50 kA	100 % of Icu
	6 to 40 A	42 kA	30 kA	15 kA	10 kA	50 % of Icu
	50/63 A	42 kA	-	15 kA	10 kA	50 % of Icu

Breaking capacity (Icn) according to IEC/EN 60898-1

Breaking capacity (Icn) according to IEC/EN 60898-1	
Ph/Ph	Voltage (Ue)
Ph/Ph	400 V
Ph/N	230 V
Rating (In)	1 to 63 A
	10000 A

Direct current (DC)

Breaking capacity (Icu) according to IEC/EN 60947-2						Service breaking capacity (Ics)
Between +/-	Voltage (Ue)					
	12 to 48 V	72 V	100 to 133 V	220 to 250 V		
Number of poles	1P	2P (in series)	3P (in series)	4P (in series)		
Rating (In)	1 to 63 A	20 kA	10 kA	10 kA	20 kA	10 kA
						100 % of Icu

Catalogue numbers

iC60H circuit breaker

Type	1P			2P		
	E45092			E45094		
Current rating (In)	Curve			Curve		
	B	C	D	B	C	D
1 A	A9F53101	A9F54101	A9F55101	A9F53201	A9F54201	A9F55201
2 A	A9F53102	A9F54102	A9F55102	A9F53202	A9F54202	A9F55202
3 A	A9F53103	-	-	-	-	-
4 A	A9F53104	A9F54104	A9F55104	A9F53204	A9F54204	A9F55204
6 A	A9F53106	A9F54106	A9F55106	A9F53206	A9F54206	A9F55206
10 A	A9F53110	A9F54110	A9F55110	A9F53210	A9F54210	A9F55210
16 A	A9F53116	A9F54116	A9F55116	A9F53216	A9F54216	A9F55216
20 A	A9F53120	A9F54120	A9F55120	A9F53220	A9F54220	A9F55220
25 A	A9F53125	A9F54125	A9F55125	A9F53225	A9F54225	A9F55225
32 A	A9F53132	A9F54132	A9F55132	A9F53232	A9F54232	A9F55232
40 A	A9F53140	A9F54140	A9F55140	A9F53240	A9F54240	A9F55240
50 A	A9F53150	A9F54150	A9F55150	A9F53250	A9F54250	A9F55250
63 A	A9F53163	A9F54163	A9F55163	A9F53263	A9F54263	A9F55263
Width in 9-mm modules	2			4		

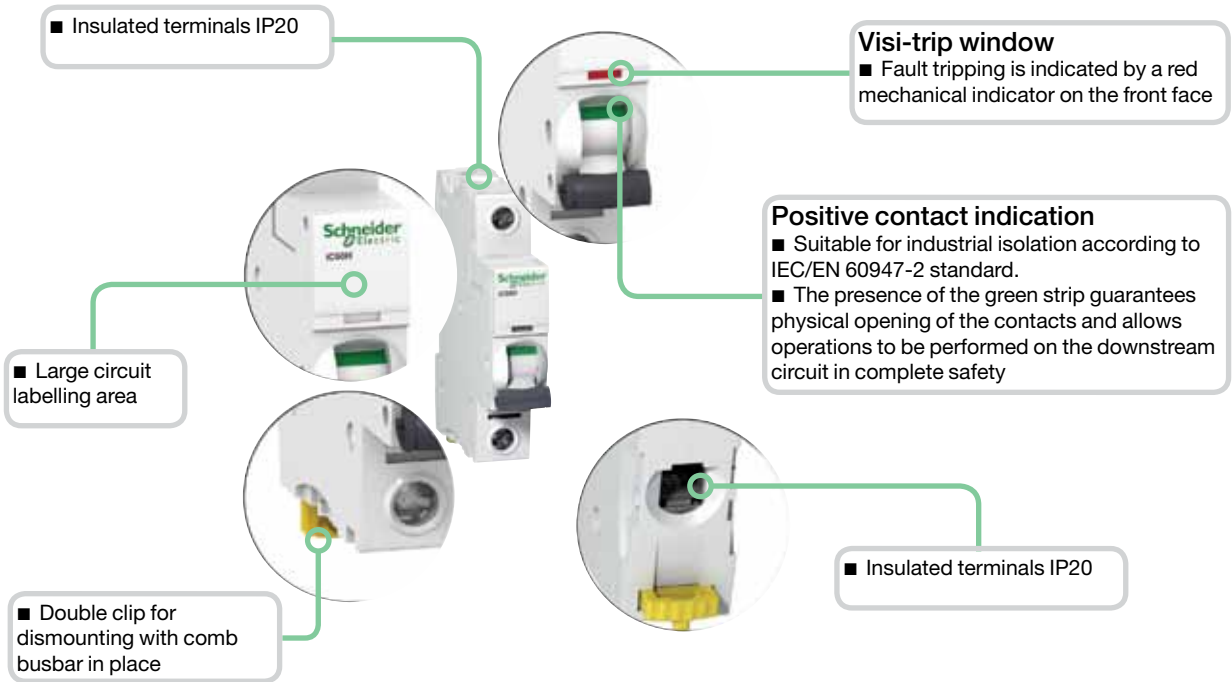

- Increased product service life thanks to:
 - overvoltage resistance by high level of industrial performances conception (pollution degree, rated impulse withstand voltage and insulation voltage),
 - high performance limitation (see limitation curves),
 - fast closing independent of the speed of actuation of the toggle.
- Remote indication, open/closed/tripped, by optional auxiliary contacts.
- Top or bottom electrical feeding.

3P			4P		
E-45095			E-45097		
Curve			Curve		
B	C	D	B	C	D
A9F53301	A9F54301	A9F55301	A9F53401	A9F54401	A9F55401
A9F53302	A9F54302	A9F55302	A9F53402	A9F54402	A9F55402
-	-	-	-	-	-
A9F53304	A9F54304	A9F55304	A9F53404	A9F54404	A9F55404
A9F53306	A9F54306	A9F55306	A9F53406	A9F54406	A9F55406
A9F53310	A9F54310	A9F55310	A9F53410	A9F54410	A9F55410
A9F53316	A9F54316	A9F55316	A9F53416	A9F54416	A9F55416
A9F53320	A9F54320	A9F55320	A9F53420	A9F54420	A9F55420
A9F53325	A9F54325	A9F55325	A9F53425	A9F54425	A9F55425
A9F53332	A9F54332	A9F55332	A9F53432	A9F54432	A9F55432
A9F53340	A9F54340	A9F55340	A9F53440	A9F54440	A9F55440
A9F53350	A9F54350	A9F55350	A9F53450	A9F54450	A9F55450
A9F53363	A9F54363	A9F55363	A9F53463	A9F54463	A9F55463
6			8		

2

Connection

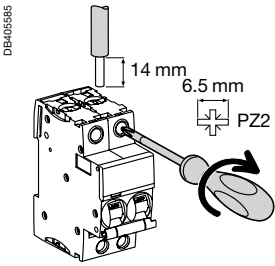

Rating	Tightening torque	Without accessory		With accessories		
		Rigid	Flexible or ferrule	50 mm ² Al terminal	Screw-on connection for ring terminal	Multi-cables terminal
1 to 25 A	2 N.m	DB122945	DB122946	DB122945	DB118789	DB118787
32 to 63 A	3.5 N.m			50 mm ²		

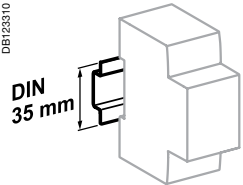

Clip on DIN rail 35 mm.

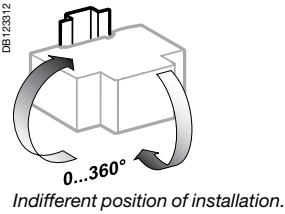

Indifferent position of installation.

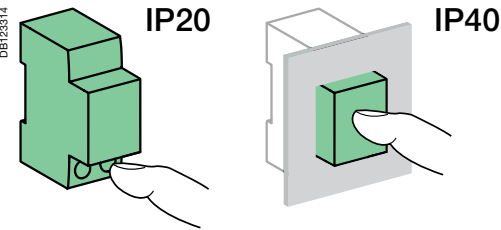

Technical data

Main characteristics	
According to IEC/EN 60947-2	
Insulation voltage (Ui)	500 V AC
Pollution degree	3
Rated impulse withstand voltage (Uimp)	6 kV
Thermal tripping	Reference temperature 50°C
Magnetic tripping	B curve 4 In ± 20 % C curve 8 In ± 20 % D curve 12 In ± 20 %
Utilization category	A
According to IEC/EN 60898-1	
Limitation class	3
Rated making and breaking capacity of an individual pole (Icn1)	Icn1 = Icn
Additional characteristics	
Breaking capacity under 1 pole with IT 380-415 V isolated neutral system (case of double fault)	40 A 4 kA 50/63 A 3 kA
Degree of protection (IEC 60529)	Device only IP20 Device in modular enclosure IP40 Insulation classe II
Endurance (O-C)	Electrical 10,000 cycles Mechanical 20,000 cycles
Overvoltage category (IEC 60364)	IV
Operating temperature	-35°C to +70°C
Storage temperature	-40°C to +85°C
Tropicalization (IEC 60068-1)	Treatment 2 (relative humidity 95 % to 55°C)

Dimensions (mm)

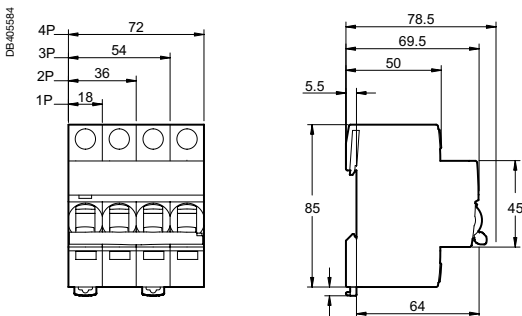

Weight (g)

Circuit-breaker	
Type	iC60H
1P	125
2P	250
3P	375
4P	500



IEC 61009-1,
IEC 61009-2-2,
BS EN 61009-1

- The single-phase iC60H RCBO's self-contained residual current device carries out complete protection of final circuits:
 - protection against short-circuits and cable overloads
 - protection of persons against electric shock by direct contact (10, 30 mA sensitivities),
 - protection of equipment against fires set by leakage currents (100 mA sensitivity).
- The neutral is not interrupted when the device is tripped. Hence iC60H RCBO can be used on most circuits, except for the ones operating under TT or IT earthing systems when the neutral needs to be isolated.

2

Alternating current (AC) 50/60 Hz

Breaking capacity (I_{cn}) according to IEC 61009-1

Ph/N	Voltage (U _e)	
	110 V	240 V
Rating (I _n) 6 to 45 A	10000 A	10000 A

Accessory

Padlocking device

- A9A27049 for pack of 10. Used to lock the toggle in the "open" or "closed" position by 4 mm diameter padlock (not supplied).

Catalogue numbers

iC60H RCBO 10000						
1P+N			A			Width in 9-mm modules
DB405038 	Voltage rating (V) 240	Sensitivity (I _{Δn}) Rating (I _n)	10 mA	30 mA	100 mA	
			-	A9D31806	-	
			-	A9D31810	-	
			-	A9D31816	-	
			-	A9D31820	-	
			-	A9D31825	-	
			-	A9D31832	-	
			-	A9D31840	-	
DB405038 	Voltage rating (V) 110	Sensitivity (I _{Δn}) Rating (I _n)	10 mA	30 mA	100 mA	2
			-	A9D19810	-	
			-	A9D19816	-	
			-	A9D19820	-	
			-	A9D19825	-	
	240	Rating (I _n)	6 A	A9D10806	A9D11806	A9D12806
			10 A	A9D10810	A9D11810	A9D12810
			16 A	A9D10816	A9D11816	A9D12816
			20 A	A9D10820	A9D11820	A9D12820
			25 A	A9D10825	A9D11825	A9D12825
			32 A	A9D10832	A9D11832	A9D12832
			40 A	A9D10840	A9D11840	A9D12840
			45 A	A9D10845	A9D11845	A9D12845
Operating frequency			50...60 Hz			

Accessory	
Type	
Padlocking device (bag of 10 pieces)	A9A27049



IEC 61009-1,
IEC 61009-2-2,
AS/NZS 61009.1

- The 2-pole iC60H2 RCBO's self-contained residual current device carries out
 - complete protection of final circuits:
 - protection against short-circuits and cable overloads,
 - protection of persons against electric shock by direct contact (30 mA sensitivities),
 - protection of equipment against fires set by leakage currents (300 mA sensitivity).
 - iC60H2 RCBO switches neutral, together with phase. It is therefore suitable for all circuits, whatever the earthing system (except for TN-C).

Alternating current (AC) 50/60 Hz

Breaking capacity (Icn) according to IEC 61009-1

Ph/N, Ph/Ph	Voltage (Ue)	
	110 V	240 V
Rating (In)	10 to 32 A	10000 A

Accessory

Padlocking device

- A9A27049 for pack of 10. Used to lock the toggle in the "open" or "closed" position by 4 mm diameter padlock (not supplied).

Catalogue numbers

iC60H2 RCBO 10000

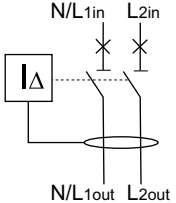
2P		A 	Width in 9-mm modules	
	110	Rating (In)	4	
		10 A		A9D19210
		16 A		A9D19216
		20 A		A9D19220
		25 A		A9D19225
		32 A		A9D19232
	240	Rating (In)		
		10 A		A9D11210
		16 A		A9D11216
		20 A		A9D11220
		25 A		A9D11225
		32 A		A9D11232
Operating frequency		50...60 Hz		

Technical data

Main characteristics		iC60H RCBO	iC60H2 RCBO
Insulation voltage (Ui)		400 V AC	
Rated impulse withstand voltage (Uimp)		4 kV	
Rated residual operating current (IΔn)		10, 30, 100 mA	30 mA
Thermal tripping	Reference temperature	50°C	
Limitation class		3	
Surge current withstand (8/20 μs) without tripping		250 A	
Rated nominal breaking capacity (Icn)		10,000 A	10,000 A
Phase/earth rated residual breaking and making capacity (IΔm)		7,500 A	7,500 A
Additional characteristics			
Degree of protection	Device only	IP20	
	Device in modular enclosure	IP40	
Endurance (O-C)	Electrical	5,000 cycles	
	Mechanical	20,000 cycles	
Operating temperature		-15°C to +60°C	
Storage temperature		-40°C to +85°C	
Tropicalization		Treatment 2 (relative humidity: 95 % at 55°C)	

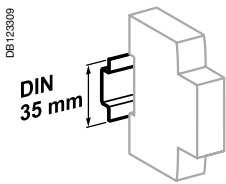

Clip on DIN rail 35 mm.

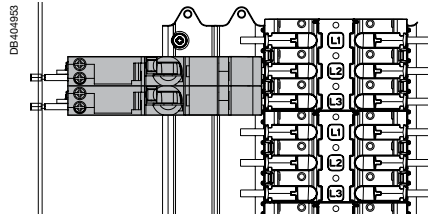

Installation on Isobar.

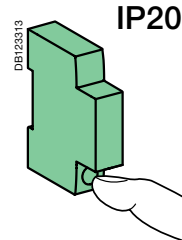

IP20

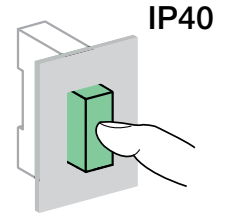

IP40

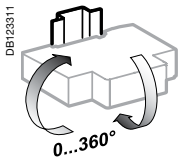

Indifferent position of installation.

Weight (g)

iC60 RCBO	
iC60H RCBO	205
iC60H2 RCBO	332

Dimensions (mm)

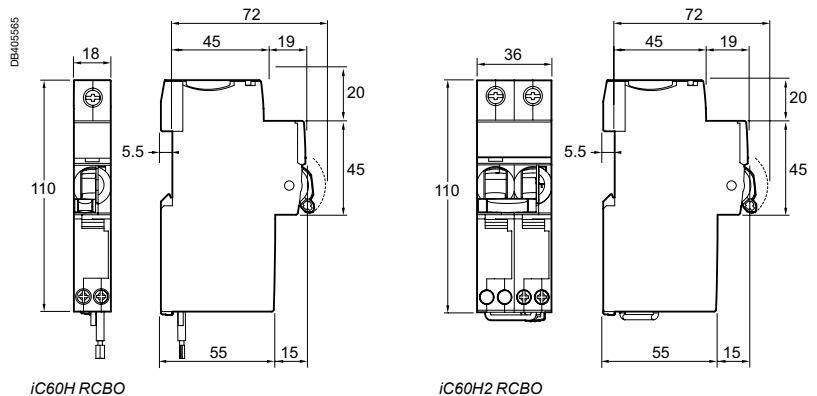

Protection

Earth leakage protection

iC60H RCBO

10, 30 and 100mA (cont.)

2

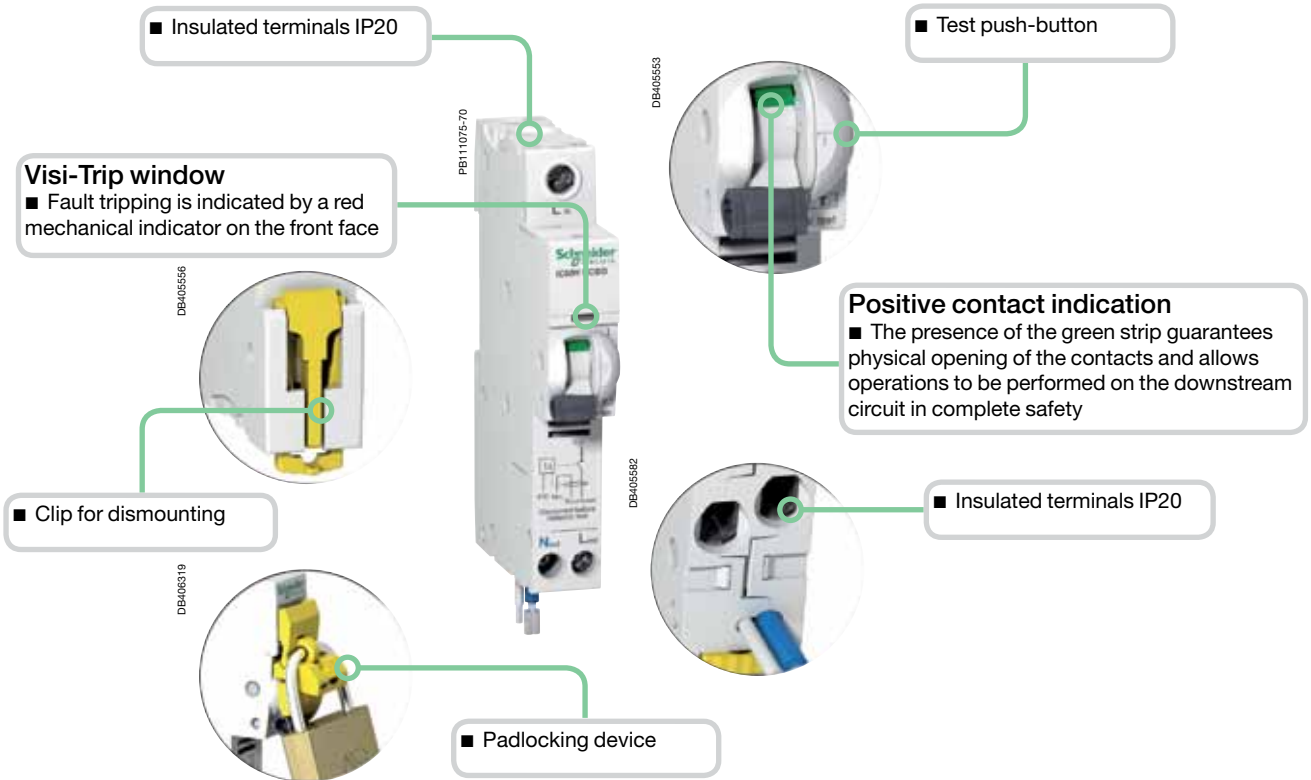

- Increased product service life thanks to fast closing independent of the speed of actuation of the toggle.
- Remote indication, open/closed/tripped, by optional auxiliary contacts.

Connection

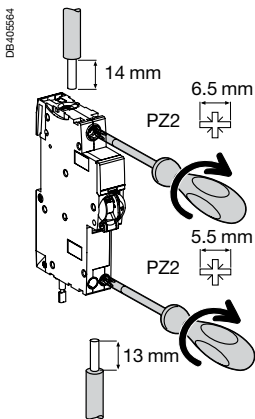

Type	Rating	Tightening torque	Copper cables	
			Rigid	Flexible
N in and L in	6 to 45 A	3.5 N.m	DB122345	DB122346
L out and N out			1 to 25 mm ²	1 to 16 mm ²
		2 N.m	1 to 16 mm ²	1 to 10 mm ²

IEC/EN 61009-1

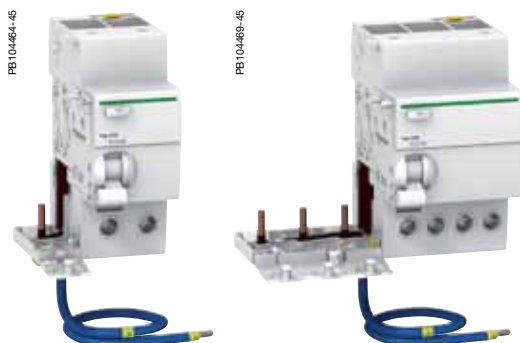

- Combined with iC60 circuit breaker, the Vigi iC60 provide:
 - protection of persons against electric shock by direct contact (30 mA),
 - protection of persons against electric shock by indirect contact (≥ 100 mA),
 - protection of installations against the risk of fire (300 mA),
 - use with 1/2 pole or 3/4 pole iC60H.

2

Catalogue numbers

Vigi iC60 add-on residual current devices						
Type	A				Width in 9 mm modules	
Product	Vigi iC60					
Auxiliaries	Without auxiliaries					
	Sensitivity	30 mA	100 mA	300 mA		
DB122462 	Rating	25 A			3	
		63 A	A9V02663 A9V01663*	A9V03663	A9V06663	4
DB122464 	Rating	63 A	A9V02763	-	A9V06763	6
Voltage rating (Ue)		230 - 240 V, 400 - 415 V Except * 110 V				
Operating frequency		50/60 Hz				



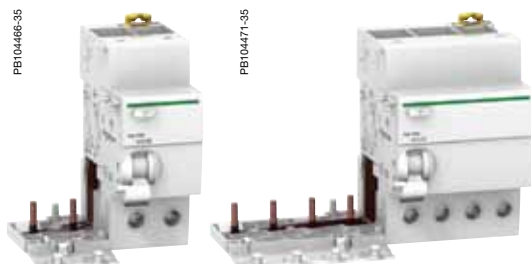

IEC/EN 61009-1

2

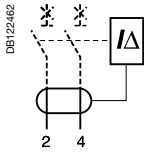

- Combined with iC60 circuit breaker, the Vigi iC60 provide:
 - protection of persons against electric shock by direct contact (30 mA),
 - protection of persons against electric shock by indirect contact (≥ 100 mA),
 - protection of installations against the risk of fire (300 mA or 500 mA)),
 - use with 2 pole or 4 pole iC60H only.

Catalogue numbers

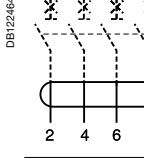
Vigi iC60 add-on residual current devices									
Type	A 							Width in 9 mm modules	
Product	Vigi iC60								
Auxiliaries	Without auxiliaries								
2P	Sensitivity	30 mA	100 mA	300 mA	500 mA	300 mA 	1000 mA 		
 DB122462	Rating	25 A	A9V51225	A9V22225	A9V54225	A9V26225	-	3	
		63 A	A9V51263	A9V22263	A9V54263	A9V26263	A9V25263	A9V29263	4
4P	Sensitivity	30 mA	100 mA	300 mA	500 mA	300 mA 	1000 mA 		
 DB122464	Rating	25 A	A9V51425	A9V22425	A9V54425	A9V26425	-	6	
		63 A	A9V51463	A9V22463	A9V54463	A9V26463	A9V25463	A9V29463	7
Voltage rating (Ue)		230 - 240 V, 400 - 415 V							
Operating frequency		50/60 Hz							

Protection Earth leakage protection

Vigi iC60 add-on residual current devices (SI type)

IEC/EN 61009-1

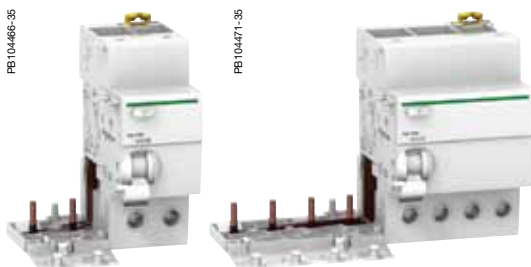

- Combined with iC60 circuit breaker, the Vigi iC60 provide:
 - protection of persons against electric shock by direct contact (≤ 30 mA),
 - protection of persons against electric shock by indirect contact (≥ 300 mA),
 - protection of installations against the risk of fire (300 mA),
 - use with 2 pole or 4 pole iC60H only.

The **SI** type provides increased immunity from electrical interference and polluted or corrosive environments.

2

Catalogue numbers

Vigi iC60 add-on residual current devices						
Type	SI					Width in 9 mm modules
Product	Vigi iC60					
Auxiliaries	Without auxiliaries					
2P	Sensitivity	10 mA	30 mA	300 mA 	1000 mA 	
	Rating	25 A	A9V30225	A9V61225	-	3
		40 A	-	A9V61240	-	4
		63 A	-	A9V61263	A9V65263	A9V39263
4P	Sensitivity	10 mA	30 mA	300 mA 	1000 mA 	
	Rating	25 A	-	A9V61425	-	6
		40 A	-	A9V61440	-	7
		63 A	-	A9V61463	A9V65463	A9V39463
Voltage rating (Ue)		230 - 240 V, 400 - 415 V				
Operating frequency		50/60 Hz				

Protection Earth leakage protection

Vigi iC60 add-on residual current devices (AC type)

2

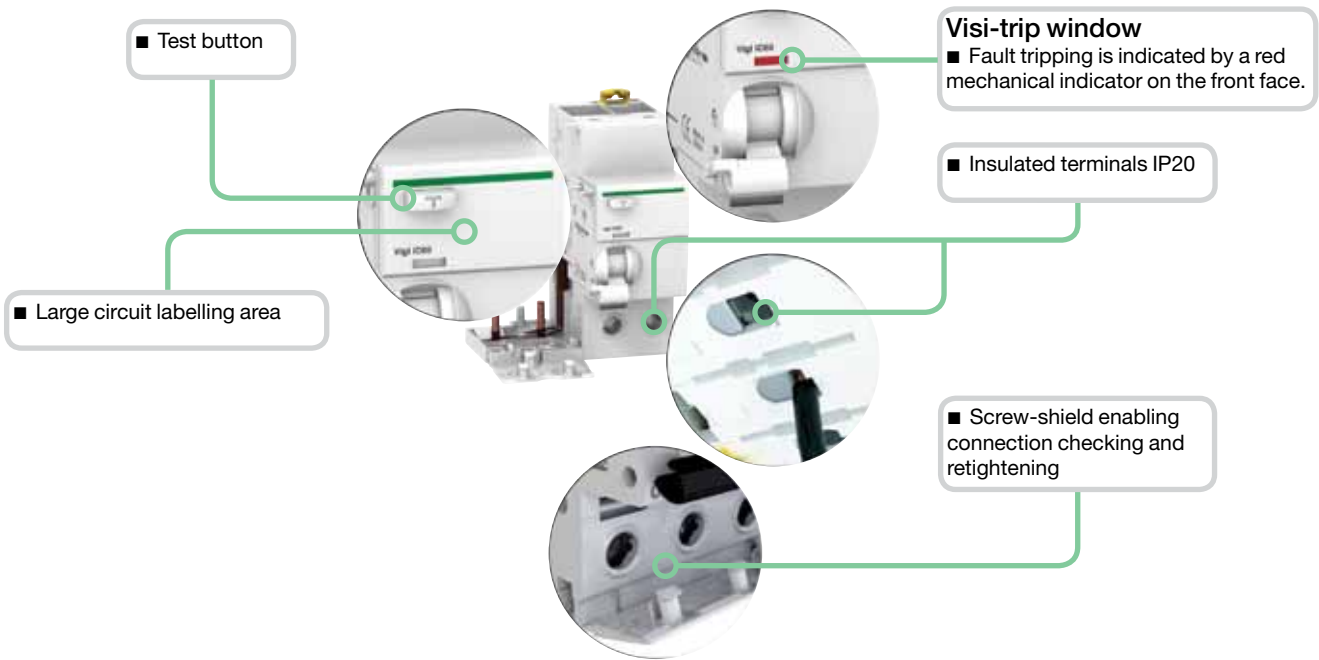

PB104466-40

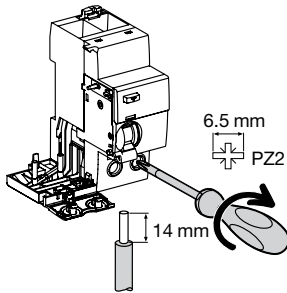

Connection

DB122948



Type	Rating	Tightening torque	Copper cables	
			Rigid	Flexible or ferrule
Vigi iC60	25 A	2 N.m		
	40 to 63 A	3.5 N.m		

DB123310

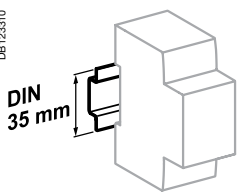

Clip on DIN rail 35 mm.

DB123312

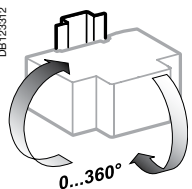

Indifferent position of installation.

DB123314

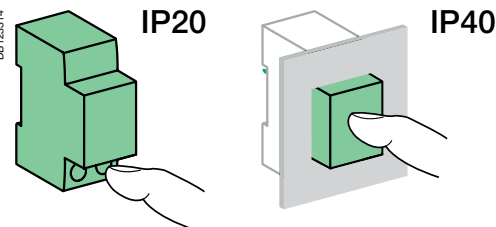



Technical data

Main characteristics

Insulation voltage (Ui)	500 V
Pollution degree	3
Rated impulse withstand voltage (Uimp)	6 kV

According to IEC/EN 61009-1

Surge current withstand (8/20 μs) without tripping	A type (no selective )	250 A
	A type (selective )	3 kA

Additional characteristics

Degree of protection	Device only	IP20
	Device in modular enclosure	IP40 Insulation classe II
Operating temperature	AC type	-5°C to +60°C
	A and <i>SI</i> types	-25°C to +60°C
Storage temperature		-40°C to +85°C

PB10472-40



PB10473-40



IEC/EN 61008-1

- The iID residual current circuit breakers provide:
 - protection of persons against electric shock by direct contact (≤ 30 mA),
 - protection of persons against electric shock by indirect contact (≥ 100 mA),
 - protection of installations against the risk of fire (300 mA or 500 mA).

Catalogue numbers

iID residual current circuit breakers									
Type	A							Width in 9 mm module	
Product	iID								
Auxiliaries									
2P	Sensitivity	10 mA	30 mA	100 mA	300 mA	500 mA	300 mA		
	Rating	16 A	A9R20216	-	-	-	-	4	
		25 A	A9R20225	A9R21225	-	A9R24225	-		
		40 A	-	A9R21240	-	A9R24240	-		A9R25240
		63 A	-	A9R21263	-	A9R24263	-		A9R25263
		100 A	-	A9R21291	-	A9R24291	-		A9R25291
4P	Sensitivity	10 mA	30 mA	100 mA	300 mA	500 mA	300 mA		
	Rating	25 A	-	A9R21425	-	A9R24425	-	8	
		40 A	-	A9R21440	A9R22440	A9R24440	A9R26440		A9R25440
		63 A	-	A9R21463	A9R22463	A9R24463	A9R26463		A9R25463
		80 A	-	A9R21480	-	A9R24480	-		A9R25480
		100 A	-	A9R21491	-	A9R24491	A9R26491		A9R25491
Voltage rating (Ue)	2P	230 - 240 V							
	4P	400 - 415 V							
Operating frequency	50/60 Hz								

iID residual current circuit breakers for 110/230 V			
Type	A		Width in 9 mm module
Product	iID		
Auxiliaries			
2P	Sensitivity	30 mA	
	Rating	63 A	A9R08263
4P	Sensitivity	30 mA	
	Rating	63 A	A9R08463
Voltage rating (Ue)	2P	110 V	
	4P	230 V	
Operating frequency	50/60 Hz		







IEC/EN 61008-1

- The iID residual current circuit breakers provide:
 - protection of persons against electric shock by direct contact (≤ 30 mA),
 - protection of persons against electric shock by indirect contact (≥ 300 mA),
 - protection of installations against the risk of fire (300 mA or 500 mA).

The **SI** type provides increased immunity from electrical interference and polluted or corrosive environments.

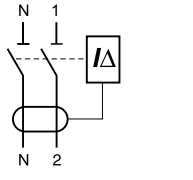
Catalogue numbers

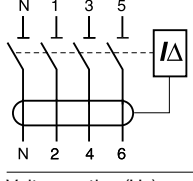
iID residual current circuit breakers								
Type	SI 						Width in 9 mm module	
Product	iID							
Auxiliaries								
2P	Sensitivity	10 mA	30 mA	300 mA	300 mA 	500 mA 		
	Rating	16 A	-	-	-	-	4	
		25 A	A9R30225	A9R61225	-	-		-
		40 A	-	A9R61240	-	A9R35240		-
		63 A	-	A9R61263	-	A9R35263		-
		100 A	-	-	-	A9R35291		-
4P	Sensitivity	10 mA	30 mA	300 mA	300 mA 	500 mA 		
	Rating	25 A	-	A9R61425	-	-	8	
		40 A	-	A9R61440	-	A9R35440		A9R37440
		63 A	-	A9R61463	A9R34463	A9R35463		A9R37463
		80 A	-	A9R31480	-	A9R35480		A9R37480
		100 A	-	A9R31491	A9R34491	A9R35491		-
Voltage rating (Ue)	2P	230 - 240 V						
	4P	400 - 415 V						
Operating frequency	50/60 Hz							

Protection Earth leakage protection

iID residual current circuit breakers (AC, A, SI types)

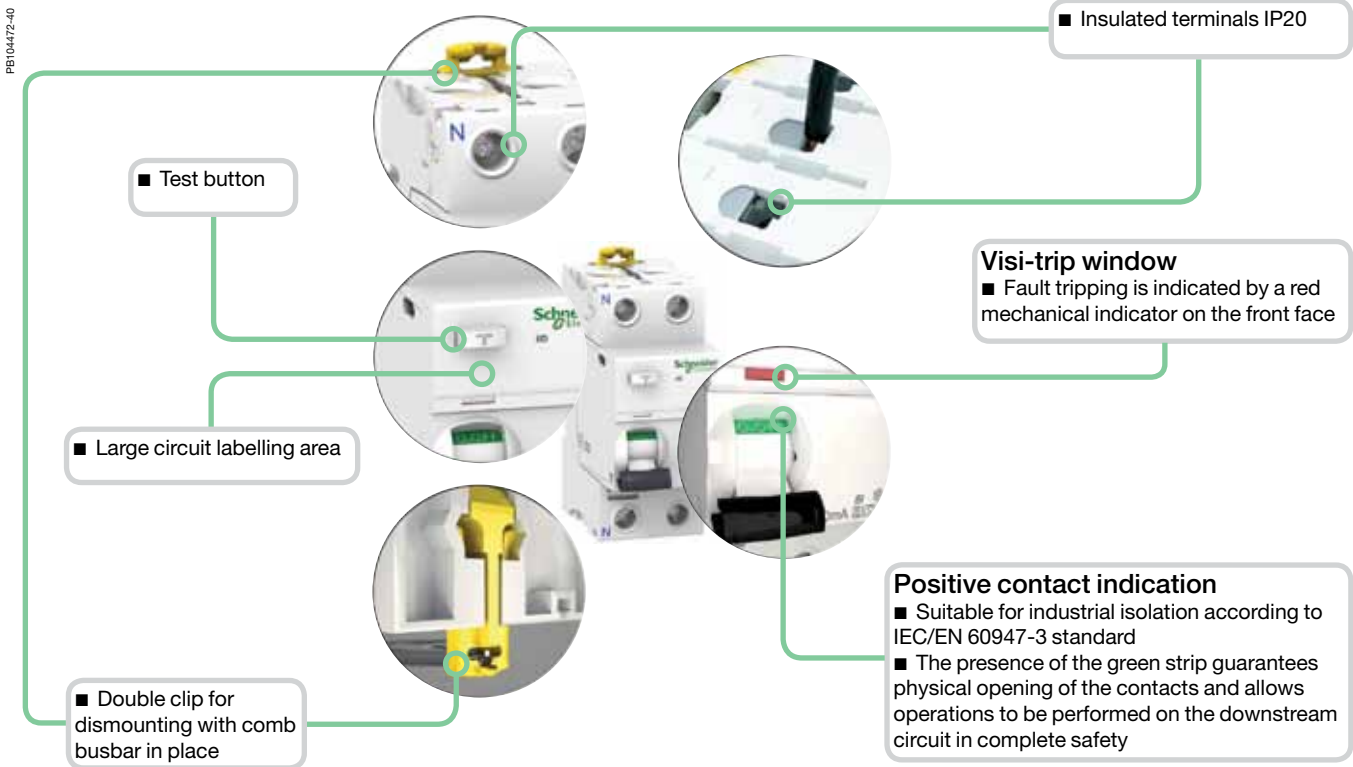

SI type

The *SI* type provides increased immunity from electrical interference and polluted or corrosive environments.

Protection Earth leakage protection

iID residual current circuit breakers (AC, A, S/I types) (cont.)

2

Connection

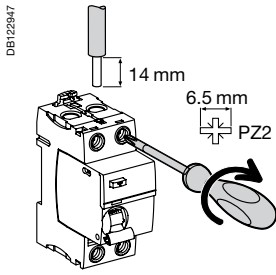

Type	Tightening torque	Without accessory		With accessories*			
		Copper cables Rigid	Copper cables Flexible or ferrule	50 mm ² Al terminal	Screw-on connection for ring terminal	Multi-cables terminal	
						Rigid cables	Flexible cables
iID	3.5 N.m	1 to 35 mm ²	1 to 25 mm ²	50 mm ²	Ø 5 mm	3 x 16 mm ²	3 x 10 mm ²

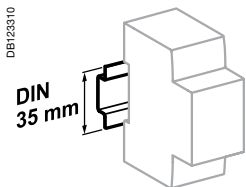

Clip on DIN rail 35 mm.

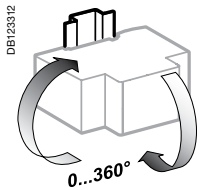

Indifferent position of installation.

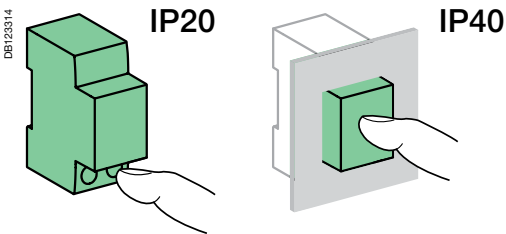

Technical data

Main characteristics			
Insulation voltage (U _i)	500 V		
Pollution degree	3		
Rated impulse withstand voltage (U _{imp})	6 kV		
According to IEC/EN 61008-1			
Making and breaking capacity (I _m /I _{Δm})	1500 A		
Surge current withstand (8/20 μs) without tripping	AC and A types (no selective Ⓢ)	250 Å	
	AC, A types (selective Ⓢ)	3 kÅ	
	S/I type	3 kÅ	
Conditional rated short circuit current (I _{nc} /I _{Δc})	With C60H	15 kA	
	With fuse	10,000 A	
Additional characteristics			
Degree of protection	Device only	IP20	
	Device in modular enclosure	IP40 Insulation classe II	
Endurance (O-C)	Electrical (AC1)	16 to 63 A	15,000 cycles
		80 to 100 A	10,000 cycles
	Mechanical		20,000 cycles
Operating temperature	AC type	-5°C to +60°C	
	A and S/I types	-25°C to +60°C	
Storage temperature	-40°C to +85°C		

Protection

Circuit protection

Earth leakage protection

Electrical auxiliaries for iC60, iID, iDPN Vigi, RCA and ARA

■ The electrical auxiliaries are combined with iC60 circuit breakers, iID residual current circuit breakers, remote tripping switch disconnectors iSW-NA, RCA remote controls and ARA automatic reclosers; they enable tripping or remote indication of their position (open/closed/tripped) upon a fault.

■ They are fastened by clips (without tools) to the left side of the breaker.

■ The iOF/SD+OF auxiliary is a 2-in-1 product: via a mechanical selector switch, it provides two contacts, OF+SD or OF+OF.

■ The iOF+SD24 auxiliary can report open/closed (OF) status information and intentional or fault tripping of the associated device (SD) to the Acti 9 Smartlink or a programmable logic controller via the Ti24 interface (24 V DC).

Tripping auxiliaries:

IEC/EN 60947-1

- iMN: undervoltage release
- iMNs: delayed undervoltage release
- iMNx: undervoltage release, independant from supply voltage
- iMX: shunt release
- iMX+OF: shunt release with open/close contact.

EN 50550

- iMSU: overvoltage release

Indication auxiliaries:

IEC/EN 60947-5-1

- iOF: open/close contact
- iSD: fault indicating contact
- iOF/SD+OF: open/close contact and switchable OF or SD contact.

IEC/EN 60947-5-4

- iOF+SD24: open/close contact OF and default indicating contact SD with Ti24 interface.

2

DB04939



2

The mounting order for the various auxiliaries must be complied with. The tripping auxiliaries (iMN, iMX) should be mounted first, as close as possible to the circuit breaker or the residual current circuit breaker. Then, the indicating auxiliaries (iOF, iSD) should be mounted, complying with their position shown in the following table.

Indicating auxiliaries

PB104474-25



PB104475-25



DB123583



















1 (iOF/SD+OF or iOF+SD24 or iSD)	1 iOF/SD+OF
1 iOF	1 (iSD or iOF or iOF/SD+OF)
None	1 iOF+SD24
None	None
1 iSD	1 iSD
None	1 (iSD or iOF or iOF/SD+OF or iOF+SD24)
1 iOF	1 (iSD or iOF or iOF/SD+OF)
None	1 (iSD or iOF or iOF/SD+OF or iOF+SD24)
1 iOF	1 (iSD or iOF or iOF/SD+OF)



Tripping devices must be mounted first. Comply with the position of the SD function.

*iSW-NA : the iSD auxiliary contact must be associated with an auxiliary (iMN, iMX, iMX+OF); it indicates that the remote tripping switch disconnector has been tripped open.

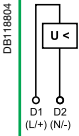
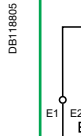
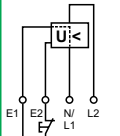

Tripping auxiliaries	Remote control	Device	Vigi iC60
 <p>PB104496-25</p>	ARA automatic recloser or RCA remote control	iC60 circuit breaker or iID residual current circuit breaker	Vigi iC60 add-on residual current device
1 (iMN, iMNs, iMNx or iMX, iMX+OF or iMSU) max.	-	 <p>PB104437-25</p> <p><i>iC60</i></p>	 <p>PB104466-25</p> <p><i>Vigi iC60</i></p>
2 (iMN, iMNs, iMNx or iMX, iMX+OF or iMSU) max.	-	-	-
2 (iMN, iMNs, iMNx or iMX, iMX+OF or iMSU) max.	-	-	-
3 iMSU max.	-	-	-
1 (iMN, iMNs, iMNx or iMX, iMX+OF or iMSU) max.	-	 <p>PB104472-25</p> <p><i>iID/iSW-NA</i></p>	-
1 (iMN, iMNs, iMNx or iMX, iMX+OF or iMSU) max.	 <p>PB108256-25</p> <p><i>ARA</i></p>	 <p>PB104437-25</p> <p><i>iC60</i></p>	 <p>PB104466-25</p> <p><i>Vigi iC60</i></p>
None	-	 <p>PB104472-25</p> <p><i>iID</i></p>	-
1 (iMX or iMN or iMSU) max.	 <p>PB106253-25</p> <p><i>RCA</i></p>	 <p>PB104437-25</p> <p><i>iC60</i></p>	 <p>PB104437-25</p> <p><i>Vigi iC60</i></p>
None	-	-	-

		Tripping						
Auxiliaries		iMN		iMNs		iMNx		
Type		Undervoltage release						
		Instantaneous		Delayed		Independent of the supply voltage		
								
Function		<ul style="list-style-type: none"> Trips the device with which it is combined when its input voltage decreases (between 70 % and 35 % U_n). Prevents device closing again until its input voltage is restored 		<ul style="list-style-type: none"> Not tripping on transient voltage dip (up to 0.2 s) 		<ul style="list-style-type: none"> Tripping of the associated device by opening of the control circuit (e.g. push-button, dry contact) A drop in the supply voltage does not trip the associated device A locking push-button control allows the circuit protected (e.g. machine control) to be placed in safety configuration 		
Wiring diagrams								
Use		<ul style="list-style-type: none"> Emergency stoppage by normally closed push button Ensures the safety of power supply circuits for several machines by preventing "uncontrolled" restarting 				<ul style="list-style-type: none"> Emergency stoppage with fail-safe principle Insensitive to control circuit voltage variation to increase service continuity Important: Before any servicing operation switch off the mains power supply (voltage presence at terminals E1/E2) 		
Catalogue numbers		A9A26960	A9A26961	A9A26959	A9A26963	A9A27108	A9A26969	A9A26971
iC60, iID, iDPN Vigi, RCA and ARA		■	■	■	■	■	■	■
Technical specifications								
Rated voltage (Ue)	V AC	220...240	48	115	220...240	24	220...240	380...415
	V DC	–	48	–	–	24	–	–
Standardised operating and non-response to voltage times (Ua)*		–	–	–	–	–	–	–
Maximum operating time		–	–	–	–	–	–	–
Minimum non-response time		–	–	–	–	–	–	–
Operating frequency	Hz	50/60		400	50/60		50/60	
Red mechanical indicator		On front face			On front face		On front face	
Test function		–			–		–	
Width in 9 mm modules		2			2		2	
Operating current		–			–		–	
Number of contacts		–			–		–	
Operating temperature	°C	-35...+70			-35...+70		-35...+70	
Storage temperature	°C	-40...+85			-40...+85		-40...+85	

*(Ua)
Voltages measured between the phase and the neutral conductor, at which the IMSU device must control the associated protective device.

Protection
Circuit protection
Earth leakage protection



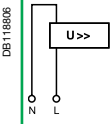
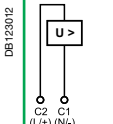
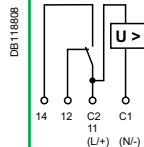



Electrical auxiliaries for
iC60, iID, iDPN Vigi, RCA and ARA
(cont.)

iMSU					iMX			iMX+OF				
Overvoltage release					Shunt release			With Open/Close auxiliary contact				
												
<ul style="list-style-type: none"> Switches off the power supply by opening the breaker with which it is combined, in the event that the phase/neutral voltage is exceeded (loss of neutral). For a four-phase network, use three iMSU tripping auxiliaries 					<ul style="list-style-type: none"> Trips the breaker when powered 			<ul style="list-style-type: none"> Includes an open/close contact (OF) to indicate the "open" or "closed" position of the breaker 				
												
<ul style="list-style-type: none"> Protection of equipment against overvoltages on the electrical network (neutral conductor break) Voltage monitoring between phase and neutral conductors 					<ul style="list-style-type: none"> Emergency stoppage by normally open push button 			<ul style="list-style-type: none"> Emergency stoppage by normally open push button Remote indication of the position of the associated breaker 				
A9A26500					A9A26476			A9A26477	A9A26478	A9A26946	A9A26947	A9A26948
■					■			■	■	■	■	■
230					100...415			48	12...24	100...415	48	12...24
-					110...130			48	12...24	110...130	48	12...24
255 V AC					275 V AC			300 V AC	350 V AC	400 V AC		
No tripping					15 s			5 s	0.75 s	0.20 s		
					3 s			1 s	0.25 s	0.07 s		
50/60					50/60					50/60		
On front face					On front face					On front face		
-					-					-		
2					2					2		
-					-					≤ 24 V DC 10 mA mini, 6 A maxi 48 V DC 2 A ≤ 130 V DC 1 A ≤ 240 V AC 6 A 415 V AC 3 A		
-					-					1 NO/NC		
-35...+70					-35...+70					-35...+70		
-40...+85					-40...+85					-40...+85		

Protection
Circuit protection
Earth leakage protection



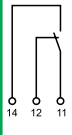
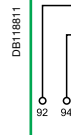

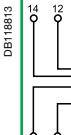
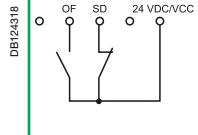
Electrical auxiliaries for
iC60, iID, iDPN Vigi, RCA and ARA
(cont.)

2

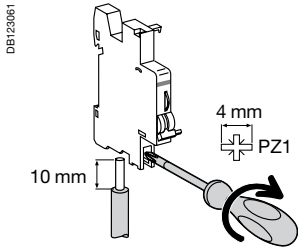
		Indication			
Auxiliaries		iOF	iSD	iOF/SD+OF	iOF+SD24
Type		Open/close auxiliary contact	Fault indicating contact	Double open/close or fault indicating contact	Double open/close and fault indicating contact
					
Function		<ul style="list-style-type: none"> Changeover contact indicates "open" or "closed" position of the breaker 	<ul style="list-style-type: none"> Changeover contact indicates position of the breaker; upon: <ul style="list-style-type: none"> electrical fault action on tripping auxiliary Same indication as VISI-TRIP 	<ul style="list-style-type: none"> The iOF/SD+OF auxiliary is a 2-in-1 product: via a mechanical selector switch, it provides two contacts, OF+SD or OF+OF 	<ul style="list-style-type: none"> 2 contacts (1 NO + 1 NC) can report the signalling information of the associated device to the Acti 9 Smartlink or a programmable logic controller: <ul style="list-style-type: none"> electrical fault actuation of the tripping auxiliary "Open" or "Closed" position of the associated device
Wiring diagrams				 	
Use		<ul style="list-style-type: none"> Remote indication of the position of the associated breaker 	<ul style="list-style-type: none"> Remote indication of tripping upon a fault of the associated breaker 	<ul style="list-style-type: none"> Remote indication of position and/or tripping upon a fault of the associated breaker 	<ul style="list-style-type: none"> Remote indication of position and tripping upon a fault of the associated breaker
Catalogue numbers		A9A26924	A9A26927	A9A26929	A9A26897
iC60, iID, iDPN Vigi, RCA and ARA		■	■	■	■
Technical specifications					
Rated voltage (Ue)	V AC	240...415	240...415	240...415	-
	V DC	24...130	24...130	24...130	24
Operating frequency	Hz	50/60	50/60	50/60	-
Red mechanical indicator		-	On front face	On front face	On front face
Test function		On toggle	On toggle	On toggle	On toggle
Width in 9 mm modules		1	1	1	1
Operating current	24 V DC	10 mA mini, 6 A maxi			2 mA mini, 50 mA maxi
	48 V DC	2 A			-
	60 V DC	1.5 A			-
	130 V DC	1 A			-
	240 V AC	6 A			-
	415 V AC	3 A			-
Number of contacts		1 NO/NC	1 NO/NC	1 NO/NC + 1 NO/NC	1 NO/NC
Operating temperature	°C	-35...+70	-35...+70	-35...+70	-25...+70
Storage temperature	°C	-40...+85	-40...+85	-40...+85	-40...+85

Connection





Type	Tightening torque	Copper cables		Multi-cables terminal	
		Rigid	Flexible	Rigid cables	Cables with ferrule
					
Indication auxiliaries	1 N.m	1 to 4 mm ²	0.5 to 2.5 mm ²	2 x 2.5 mm ²	2 x 1.5 mm ²
Tripping auxiliaries	1 N.m	1 to 6 mm ²	0.5 to 4 mm ²	2 x 2.5 mm ²	2 x 2.5 mm ²

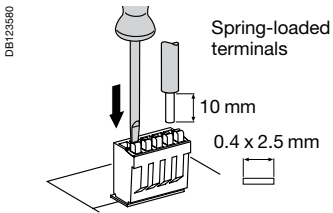

Ti24 connector connection



Type	Catalogue numbers	Copper cables	
		Rigid	Flexible
			
Ti24 interface	A9XC2412	1 x 0.5 to 1.5 mm ²	1 x 0.5 to 1.5 mm ²

Ti24 prefabricated cables connection

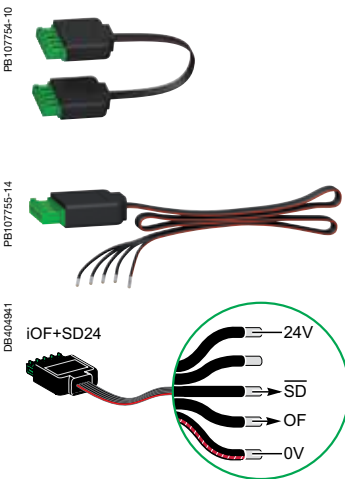

Type	Catalogue numbers	Length
Connection for Acti 9 Smartlink		
6 short prefabricated	A9XCAS06	100 mm
6 medium-sized prefabricated	A9XCAM06	160 mm
6 long prefabricated	A9XCAL06	870 mm
Connection for PLC type terminals		
6 long prefabricated on a single side	A9XCAU06	870 mm



Protection

Circuit protection

Earth leakage protection

Accessories for iC60, iID, iDPN Vigi, Reflex iC60, RCA, ARA and iSW

2

		Mounting						
Accessories		Rotary handle			Plug-in base			
								
Function		<p>Front or side-mounted control</p> <ul style="list-style-type: none"> ■ Degree of protection: IP55 rotary handle ■ Installation: <ul style="list-style-type: none"> □ the control mechanism is mounted on the device □ the rotary handle is fixed to the front or side of the enclosure ■ Front-mounted (on door or faceplate) <ul style="list-style-type: none"> ■ Prevents the door from opening when the device is in the ON position (can be deactivated) ■ Can be padlocked when the device is in the "open" position (can be padlocked with the device in the "closed" position subject to adaptation) ■ Can be locked by padlock of (dia. 5 to 8 mm), not supplied with the device ■ Pushbutton: iID test available in the front face of the rotary handle 			<ul style="list-style-type: none"> ■ The Laser Square tool brings the accuracy to align the circuit breaker and the rotary handle 		<p>Allows a breaker to be removed or replaced quickly, without handling the connections</p> <ul style="list-style-type: none"> ■ Degree of protection: IP20 ■ Consists of: <ul style="list-style-type: none"> □ a base to be fastened on a rail (or panel) □ 2 "blades" to be fastened in the device's terminals ■ Connection: tunnel terminals for cable up to 35 mm² rigid, 25 mm² flexible, ■ Installation: <ul style="list-style-type: none"> □ in universal enclosure □ on horizontal rail ■ Height: 178 mm ■ Not compatible with Vigi iC60 and auxiliaries ■ Can be locked by padlock of (dia. 6 mm), not supplied with the device 	
Catalogue numbers		A9A27005	A9A27006	A9A27008	GVAPL01	A9A27003 (1 per pole)		
		Operating sub-assembly						
		+	+					
		Black handle	Red handle	No handle				
Set of		1	1	1	1	1		
Suitability								
iC60	■ 2P, 3P, 4P							
iSW	■ 2P, 3P, 4P							
iC60 + Vigi iC60	■ 2P, 3P, 4P							
iID	■					■ ≤ 63 A		
Reflex iC60 or RCA+iC60 or ARA+iC60	-							
ARA+iID	-							

Protection
 Circuit protection
 Earth leakage protection

Accessories for iC60, iID, iDPN Vigi,
 Reflex iC60, RCA, ARA and iSW (cont.)

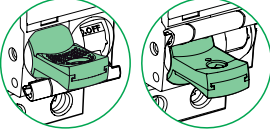
Padlocking device			
PE104492-15			
DB12399B			
<p>Used to padlock breaker in open or closed position</p> <ul style="list-style-type: none"> ■ Padlock diameter: 3 to 6 mm ■ Sealable (max. diameter: 1.2 mm) ■ Locking in ON position does not prevent tripping of the breaker in the event of faults ■ Suitable for IEC/EN 60947-2 compliant disconnection 			
	MCB/RCCB	MCB in ISOBAR	RCBO in ISOBAR
	A9A26970	SEA9LA	A9A27049
	10	3	10
	<ul style="list-style-type: none"> ■ ■ ■ ■ ■ 		





Protection

Circuit protection

Earth leakage protection

Accessories for iC60, iID, iDPN Vigi, Reflex iC60, RCA, ARA, iSW (cont.)

2





Security						
Accessories	Screw shield		Terminal shield		Inter-pole barrier	Spacer
						
Function	Prevents any contact with the connecting screws <ul style="list-style-type: none"> Upgrades degree of protection to IP20D Sealable, max. diameter 1.2 mm 		Prevents any contact with the terminals <ul style="list-style-type: none"> Upgrades degree of protection to IP20D Sealable, max. diameter 1.2 mm Set of two, for upstream and downstream terminals For 3 poles: A9A26975 + A9A26976 For 4 poles: 2 X A9A26976 		Enhances insulation between connections: cables, terminals, lugs, etc	<ul style="list-style-type: none"> Used to: <ul style="list-style-type: none"> complete rows separate devices. Width: 1 x 9 mm module Allows cable routing from one row to another, (above and below), up to 6 mm²
Catalogue numbers	A9A26982	A9A26981	A9A26975	A9A26976	A9A27001	A9A27062 DIN mounted A9A27063 Breaker mounted
Set of	12 x 1 pole	20 x 4 poles (splittable)	2 x 1 pole	2 x 2 poles	10	5
Suitability						
iC60	-	■	■	■	■	■
iSW	-	-	■	■	■	■
Vigi iC60	■	-	-	-	-	■
iID	-	■	-	■	■	■
Reflex iC60 or RCA+iC60 or ARA+iC60	-	■	■	■	■	■
ARA+iID	-	■	-	■	■	■

Protection

Circuit protection

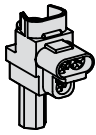
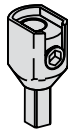
Earth leakage protection

Accessories for iC60, iID, iDPN Vigi, Reflex iC60, RCA, ARA, iSW (cont.)

		Connection		
Accessories	Multi-cable terminal	50 mm ² terminal Al	Screw-on connection for ring terminal	
				
Function				
	For 3 copper cables: ■ Rigid up to 16 mm ² ■ Flexible up to 10 mm ²	For aluminium cables from 16 to 50 mm ²	For lug tipped cables, front or rear mounting	
				
Catalogue numbers	19091	19096	27060	27053
Set of	4	3	1	8
iC60 ≤ 25 A	-	-	-	■
Reflex iC60 ≤ 25 A	-	-	-	■
iC60 > 25 A	■	■	■	■
Reflex iC60 40 A, iSW	-	-	-	-
Vigi iC60	-	-	-	-
iID	■	■	■	■
iDPN Vigi	-	-	-	■
iSW-NA	■	■	■	■
Tightening torque	2 N.m		10 N.m	2 N.m
Length stripping	11 mm		13 mm	-
Tools to use	Dia. 5 mm or PZ2		Hc 1/5" or 5 mm	Dia. 5mm

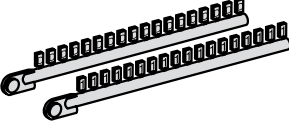
		Marking				
Accessories	Marker strip					
						
Used for connection identification						
Catalogue numbers	0: AB1-R0 1: AB1-R1 2: AB1-R2 3: AB1-R3 4: AB1-R4	5: AB1-R5 6: AB1-R6 7: AB1-R7 8: AB1-R8 9: AB1-R9	A: AB1-GA B: AB1-GB C: AB1-GC D: AB1-GD E: AB1-GE F: AB1-GF G: AB1-GG H: AB1-GH I: AB1-GI	J: AB1-GJ K: AB1-GK L: AB1-GL M: AB1-GM N: AB1-GN O: AB1-GO P: AB1-GP Q: AB1-GQ R: AB1-GR	S: AB1-GS T: AB1-GT U: AB1-GU V: AB1-GV W: AB1-GW X: AB1-GX Y: AB1-GY Z: AB1-GZ	+ : AB1-R12 - : AB1-R13 blank: AB1-RV
Set of	250					
iC60, Reflex iC60, iSW	■ 4 markers max. per pole					
Vigi iC60	■ 4 markers max. per device					
iID	■ 4 markers max. per device					
iDPN Vigi	■ 4 markers max. per device					
iSW-NA	■ 4 markers max. per device					

Protection

Circuit protection

Earth leakage protection

Accessories for iC60, iID, iDPN Vigi, Reflex iC60, RCA, ARA, iSW (cont.)

Dimensions (mm)

2

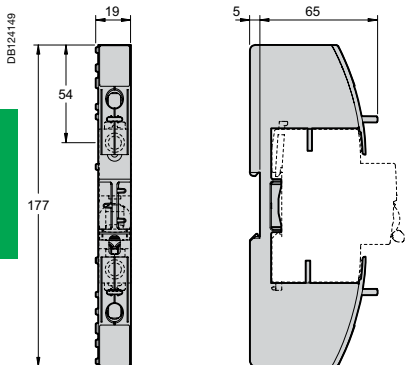

Plug-in base

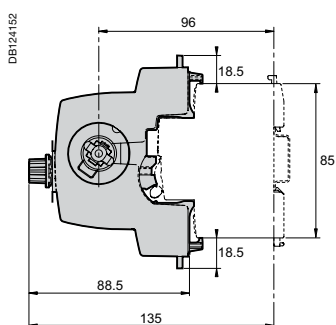

Adapter mechanism

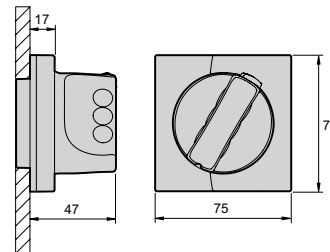

Handle

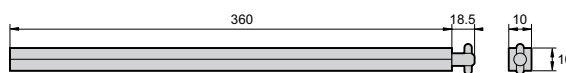

Rotary handle

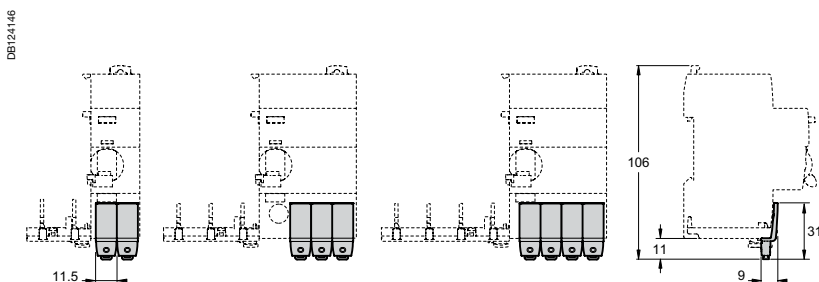

Screw shield 1P (A9A26982)

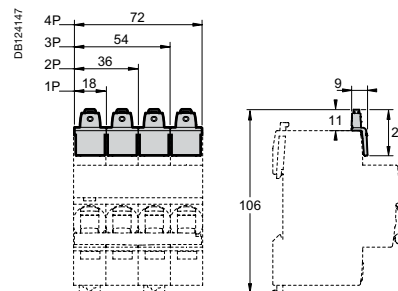

Screw shield 4P (A9A26981)

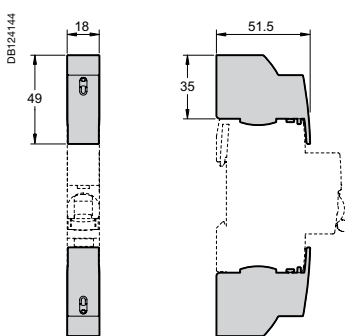

Terminal shield 1P

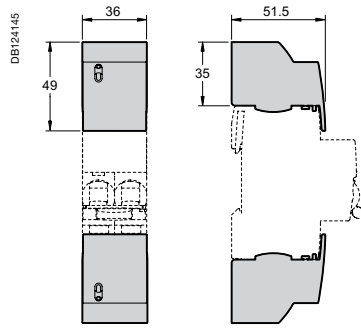

Terminal shield 2P

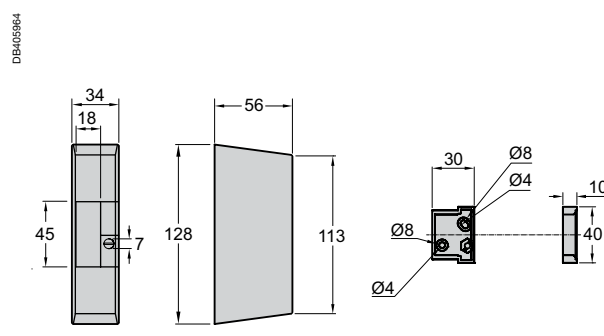

Wall mounted

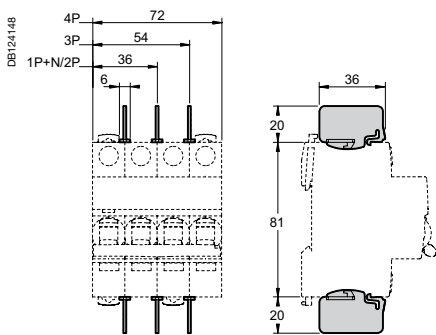

Inter-pole barrier

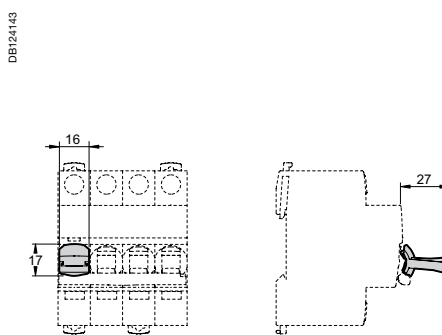

Padlocking device

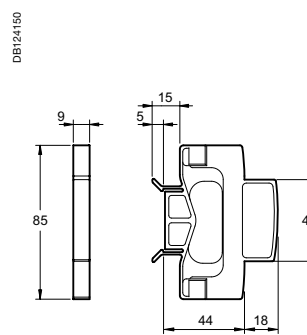

Spacer

Rotary handle installation

Dimensions (mm)

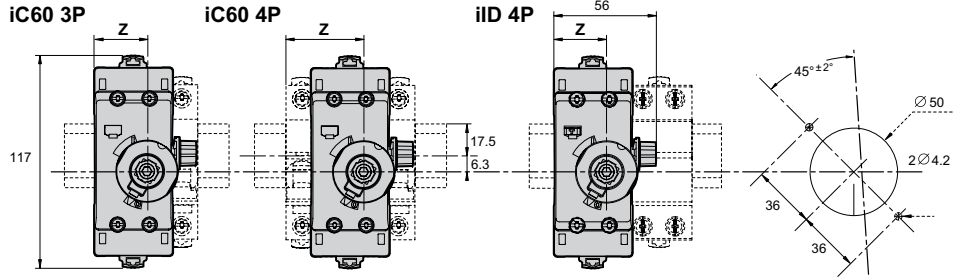
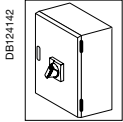

iC60	Z (mm)
2P	25.3
2P + Vigi	25.3
3P	25.3
3P + Vigi	43
4P	43
4P + Vigi	43

iID	Z (mm)
2P	25.3
4P	25.3

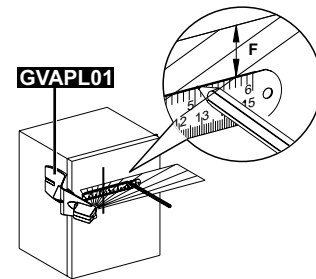
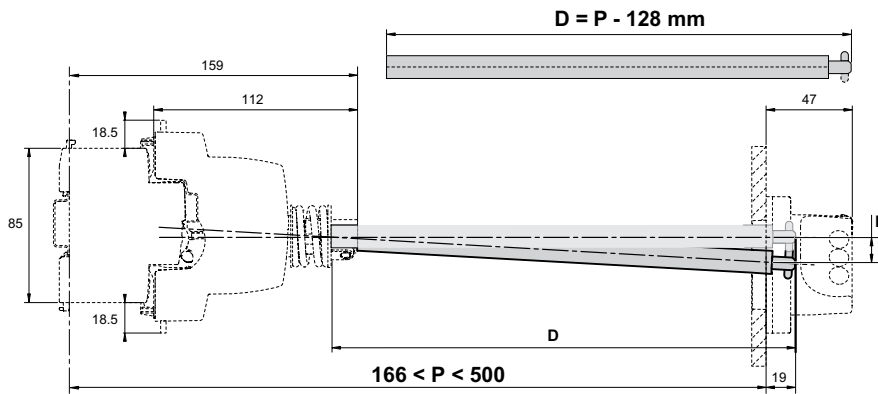

P (mm)	F (mm)
300	5
500	11

Rotary handle: front mounted control

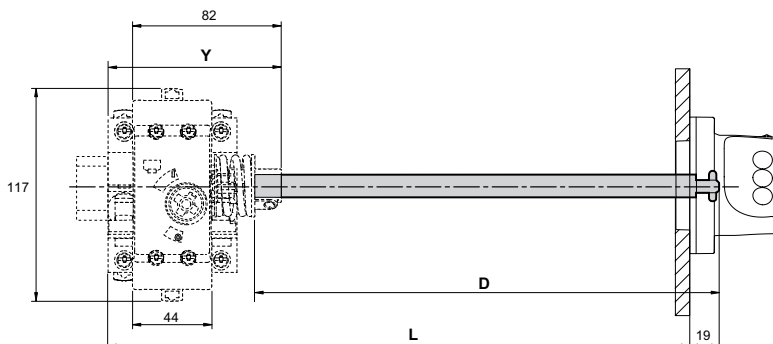
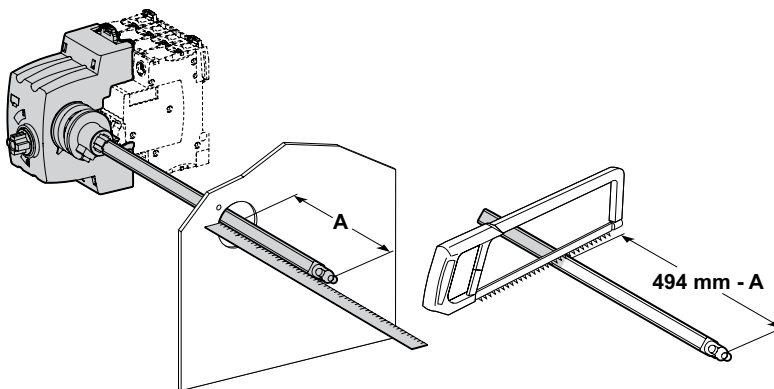
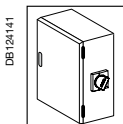

iC60	X (mm)	Y (mm)
2P	44.5	76.8
2P + Vigi	44.5	76.8
3P	44.5	76.8
3P + Vigi	62	94.5
4P	62	94.5
4P + Vigi	62	94.5

iID/iSW-NA	X (mm)	Y (mm)
2P	44.5	76.8
4P	44.5	76.8



Rotary handle: side mounted control

iDPN circuit breakers **pages 3/2 to 3/4**

Residual current devices iDPN Vigi **pages 3/5 to 3/7**

iC120H circuit breakers (curves B, C, D) **pages 3/8 to 3/10**

Vigi iC120 add-on residual current devices **pages 3/11 to 3/15**

 Type AC page 3/11

 Type A page 3/12

 Type SI page 3/13

 Technical pages 3/14 to 3/15

Accessories for iC120, DPN, DPN Vigi, C60H-DC, SW60-DC, C60NA-DC, C60PV-DC, iSW devices **pages 3/16 to 3/19**

 Installation page 3/16

 Safety page 3/17

 Connection page 3/18

 Identification page 3/19

Electrical auxiliaries for iC120, DPN, DPN Vigi, ID, C60H-DC, SW60-DC, C60PV-DC, C60NA-DC devices **pages 3/20 to 3/23**

 Tripping pages 3/20 to 3/21

 Identification page 3/22

 Connection page 3/23

P25M **pages 3/24 to 3/27**

 Electrical auxiliaries page 3/26

 Accessories page 3/27





The protection of property and people against direct or indirect contacts, insulation faults and fire hazards is implemented by residual current devices obtained by the combination of a circuit breaker and an earth leakage module.

IEC/EN 60898-1

The circuit breakers are designed for protection against short-circuit and overload currents, for the control and disconnection of final distribution circuits in service sector, agricultural and industrial applications, in TT earthing system or with multiple earthed neutral (TN-S) requiring neutral cutoff without its protective device.

3



Catalogue numbers

iDPN N circuit breakers		
Type	6000 1P+N	
Auxiliaries	Modules CA907008 and CA907010	
Vigi	Module CA902013	
Rating (In)	B curve	C curve
1 A	-	A9N21552
2 A	-	A9N21553
3 A	-	A9N21554
4 A	A9N17515	A9N21722
6 A	A9N17516	A9N21555
10 A	A9N17517	A9N21556
13 A	A9N17518	A9N21725
16 A	A9N17519	A9N21557
20 A	A9N17520	A9N21558
25 A	A9N17521	A9N21559
32 A	A9N17522	A9N21560
40 A	A9N17523	A9N21561
Width in 9-mm modules	2	

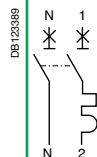

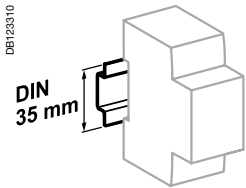

Clip on DIN rail 35 mm.

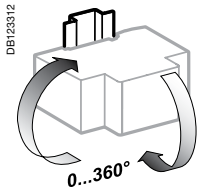

Indifferent position of installation.

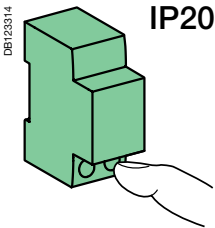

IP20

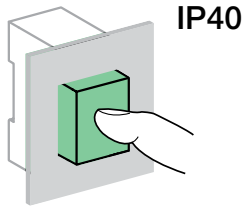

IP40

Dimensions (mm)

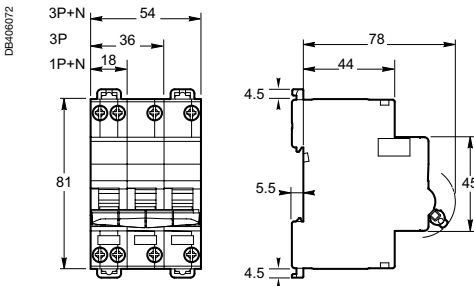

Technical data

Main characteristics		iDPN N
Insulation voltage (Ui)	Phase-to-neutral	400 V
	Phase-to-phase	440 V
Voltage rating (Ue)	Phase-to-neutral	230 V
	Phase-to-phase	400 V
Magnetic tripping	B curve	3 to 5 In
	C curve	5 to 10 In
	D curve	10 to 14 In

According to IEC/EN 60898-1

Limitation class	3
Rated breaking capacity (Icn)	6000 A
Service breaking capacity (Ics)	100 % Icn
Rated breaking and making capacity on a single pole (Icn1)	Icn1 = Icn

According to IEC 60947-2

Rated impulse withstand voltage (Uimp)	4 kV
Breaking capacity (Icu)	10 kA
Service breaking capacity (Ics)	75 % Icu
Pollution degree	3

Additional characteristics

Degree of protection (IEC 60529)	Device only	IP20	
	Device in modular enclosure	IP40	
Endurance (O-C)	Electrical	≤ 20 A	20000 cycles
		≥ 25 A	10000 cycles
	Mechanical	20000 cycles	
Operating temperature	-25°C to +70°C		
Storage temperature	-40°C to +70°C		
Tropicalization (IEC 60068-1)	Treatment 2 (relative humidity of 95 % at 55°C)		
Neutral opening and closing shifted relative to phases	No surge upon operation of the device		

Weight (g)

Circuit breaker	
Type	iDPN
1P+N	115

3

■ Reinforced cable pull-out strength: serrated terminals

■ Automatic cable guiding in the correct position: terminals with guard

■ Assembly and disassembly with comb busbar in place by operating toggle latches at the top and bottom of the products

■ Where there is a comb tooth, the connection of cables of cross section 16 mm² remains possible

Markings

- Area for 4 marking clips alongside the downstream terminal
- Area for marking by 12 mm high label on the front panel

Positive contact indication

- A green strip on the toggle guarantees opening of all the poles in safety conditions (padlocking possible) for work to be carried out on live parts



Connection

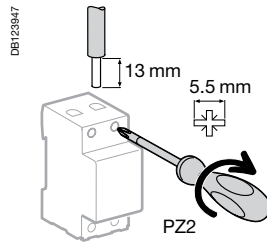

Rating	Tightening torque	Copper cables	
		Rigid	Flexible or with ferrule
DT40, iDPN, C40	2 N.m	DB122945 	DB122946
DT60	3.5 N.m	0.75 to 16 mm ²	0.33 to 10 mm ²
		0.5 to 35 mm ²	0.5 to 25 mm ²

- Connection by comb busbar or cables (as per EN 50027).



IEC/EN 61009

- The iDPN Vigi residual current device provide complete protection for final circuits (against overcurrents and insulation faults):
 - protection for users against electric shocks by direct contacts (≤ 30 mA),
 - protection for users against electric shocks by indirect contacts (300 mA),
 - protection of the installations against fire risks (300 mA).



iDPN H Vigi

3

iDPN N Vigi 6000			
Type	AC	Width in 9 mm modules	
Auxiliaries			
1P+N Curve B	Sensitivity	30 mA	
	Rating (In)	4 A	A9D55604
		6 A	A9D55606
		10 A	A9D55610
		16 A	A9D55616
		20 A	A9D55620
		25 A	A9D55625
		32 A	A9D55632
	40 A	A9D55640	
1P+N Curve C	Sensitivity	30 mA	
	Rating (In)	6 A	A9D31606
		10 A	A9D31610
		16 A	A9D31616
		20 A	A9D31620
		25 A	A9D31625
		32 A	A9D31632
		40 A	A9D31640
Voltage rating (Ue)		230 V AC	
Operating frequency		50 Hz	

iDPN N Vigi 6000			
Type	A	Width in 9 mm modules	
Auxiliaries			
1P+N Curve B	Sensitivity	30 mA	
	Rating (In)	10 A	A9D06610
		16 A	A9D06616
		20 A	A9D06620
1P+N Curve C	Sensitivity	30 mA	
	Rating (In)	10 A	A9D01610
		16 A	A9D01616
		20 A	A9D01620
Voltage rating (Ue)		230 V AC	
Operating frequency		50 Hz	

3

DB40595-40

■ Fast contact closure

Visi-trip double window

- Fault tripping circuit breaker is indicated by a red mechanical indicator on the front face.
- Earth fault is indicated by a red mechanical indicator on the front face

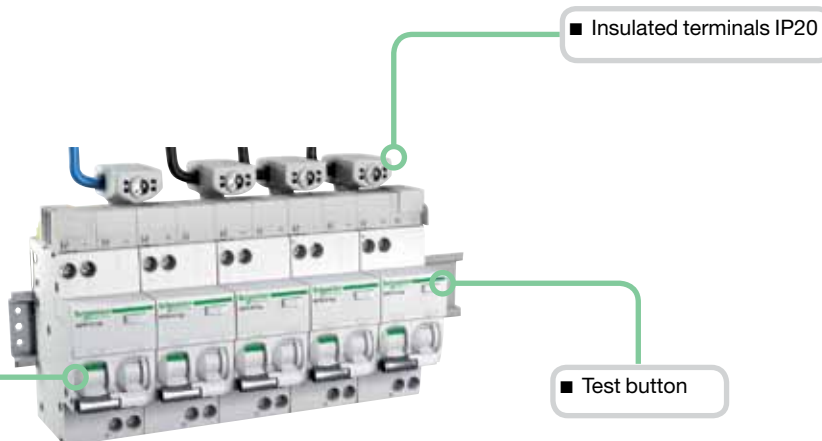

Positive contact indication

- A green strip on the toggle guarantees opening of all the poles in safety conditions (padlocking possible) for work to be carried out on live parts

Connection

DB123847

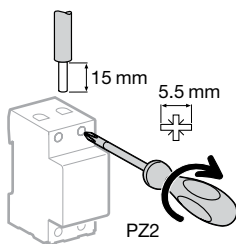

Rating	Tightening torque	Copper cables	
		Rigid	Flexible or ferrule
4 to 40 A	2 N.m	DB123845 	DB123846
		1 to 16 mm ²	1 to 10 mm ²

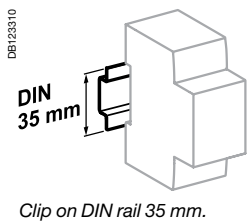

Clip on DIN rail 35 mm.

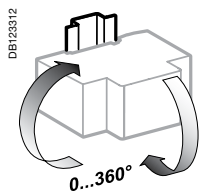

Indifferent position of installation.

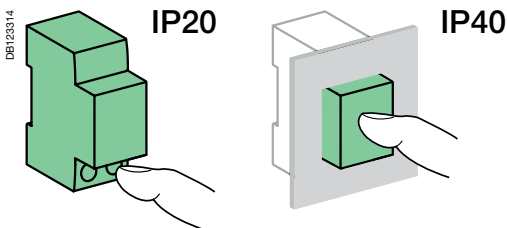

Dimensions (mm)

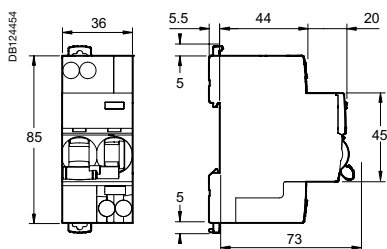

Technical data

Main characteristics

Insulation voltage (Ui)	400 V AC
Pollution degree	3
Rated impulse withstand voltage (Uimp)	4 kV
Setting temperature for ratings	30°C
Magnetic tripping	Curve B Curve C
	Between 3 and 5 In Between 5 and 10 In

According to EN 61009

Limitation class	
Rated breaking capacity (Icn)	6000 A
Rated residual breaking and making capacity (IΔm)	6000 A
8/20 μs impulse withstand	Type AC 250 A

Additional characteristics

Earth leakage protection with instantaneous tripping	30 mA	
Degree of protection (IEC 60529)	Device only Device in modular enclosure	IP20 IP40 Insulation classe II
Endurance (O-C)	Electrical Mechanical	≤ 20 A ≥ 25 A 20,000 cycles 10,000 cycles 20,000 cycles
Overvoltage category (IEC 60364)		III
Operating temperature	Type AC	-5°C to +60°C
Storage temperature		-40°C to +85°C
Tropicalization (IEC 60068-1)		Treatment 2 (relative humidity 95 % to 55°C)

Weight (g)

Residual current device

Type	iDPN Vigi
1P+N	125



IEC/EN 60898-1, IEC 60947-2

iC120H circuit breakers are multistandard circuit breakers that combine the following functions:

- circuit protection against short-circuit currents
- circuit protection against overload currents
- suitability for isolation in the industrial sector to IEC/EN 60947-2
- fault tripping and indication by adding auxiliaries.

3



Alternating current (AC) 50/60 Hz

Breaking capacity (Icu) to IEC/EN 60947-2					Service breaking capacity (Ics)
Type	Voltage (V)				
1P	12 to 130 V	220 to 240 V	380 to 415 V	440 V	50 % of Icu
Rating (In)	63 to 125 A	30 kA	15 kA	4,5 kA ⁽¹⁾	
2P, 3P, 4P	12 to 130 V	220 to 240 V	380 to 415 V	440 V	50 % of Icu
	63 to 125 A	-	30 kA	15 kA	

Breaking capacity (Icn) to IEC/EN 60898-1		
Type	Voltage (V)	
1P, 2P, 3P, 4P	230 to 400 V	
Rating (In)	63 to 125 A	15000 A
		50 % of Icn

⁽¹⁾ One-pole breaking capacity in IT isolated neutral system (double fault).

Direct current (DC)

Breaking capacity (Icu) according to IEC/EN 60947-2						Service breaking capacity (Ics)
	Voltage (Ue)					
Between +/-	12 to 125 V	≤ 144 V	≤ 250 V	≤ 375 V	≤ 500 V	100 % of Icu
Number of poles	1P		2P	3P	4P	
Rating (In)	63 to 125 A	20 kA	15 kA	15 kA	15 kA	

Catalogue numbers

iC120H circuit breaker						
Type	1P			2P		
Rating (In)	Curve			Curve		
	B	C	D	B	C	D
63 A	A9N18401	A9N18445	A9N18489	A9N18412	A9N18456	A9N18500
80 A	A9N18402	A9N18446	A9N18490	A9N18413	A9N18457	A9N18501
100 A	A9N18403	A9N18447	A9N18491	A9N18414	A9N18458	A9N18502
125 A	A9N18404	A9N18448	A9N18492	A9N18415	A9N18459	A9N18503
Width in 9 mm modules	3			6		

Note: For current ratings below 63 amp use IC60H

PB107916-40

■ Terminals insulated to IP20



■ Location for 4 clip-on terminal markers

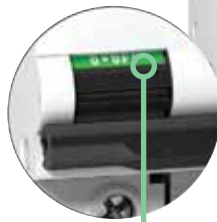

Positive contact indication

- Suitability for isolation in the industrial sector to IEC/EN 60947-2.
- The presence of the green strip guarantees that the contacts open physically and allows work to be carried out safely on the downstream circuit.

- Longer product service life thanks to:
 - good overvoltage withstand capacity: products designed to provide a high industrial performance level (degree of pollution, rated impulse withstand voltage and insulation voltage).
 - high limitation performances (see limitation curves).
 - fast closure independent of toggle operating speed.
- Remote indication of the open/closed/tripped state by auxiliary contacts (optional).
- Power supply from above or below.

3P			4P		
Curve			Curve		
B	C	D	B	C	D
A9N18423	A9N18467	A9N18511	A9N18434	A9N18478	A9N18522
A9N18424	A9N18468	A9N18512	A9N18435	A9N18479	A9N18523
A9N18425	A9N18469	A9N18513	A9N18436	A9N18480	A9N18524
A9N18426	A9N18470	A9N18514	A9N18437	A9N18481	A9N18525
9			12		

Connection

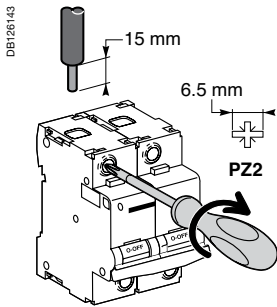

Rating	Tightening torque	Without access.		With accessories			
		Copper cables	50 mm ² Al term.	Screw-on connection for ring terminal ⁽¹⁾	Multi-cable terminal		
		Rigid	Flexible or with ferrule		Rigid cables	Flexible cables	
		DB122945	DB122946	DB122935	DB118789	DB118787	
63 to 125 A	3.5 N.m	1 to 50 mm ²	1.5 to 35 mm ²	16 to 50 mm ²	Ø 5 mm	3 x 16 mm ²	3 x 10 mm ²

(1) For lugs up to 63 A, front or rear accessories.

3

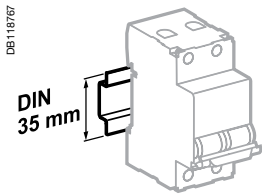

Clips onto 35 mm DIN rail.

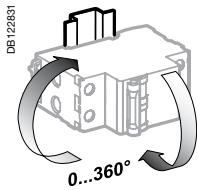

Any installation position.

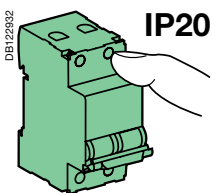

IP20

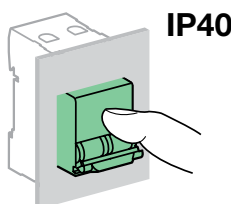

IP40

Technical data

Main characteristics

To IEC/EN 60947-2

Insulation voltage (Ui)	500 V AC
Degree of pollution	3
Rated impulse withstand voltage (Uimp)	6 kV
Thermal tripping	Reference temperature
	50°C

To IEC/EN 60898-1

Magnetic tripping	Curve B	3 and 5 In
	Curve C	5 and 10 In
	Curve D	10 and 14 In
Limitation class		3

Additional characteristics

Degree of protection (IEC 60529)	Device only	IP20	
	Device in a modular enclosure	IP40 (IPXXD)	
Endurance (O-C)	Electrical	63 A	10000 cycles (O-C)
		80...125 A	5000 cycles (O-C)
	Mechanical		20000 cycles
Operating temperature		-30°C to +70°C	
Storage temperature		-40°C to +80°C	
Tropicalisation (IEC 60068-1)		Treatment 2 (relative humidity 95% at 55°C)	

Weight (g)

Circuit breaker

Type	iC120H
1P	205
2P	410
3P	615
4P	820

Dimensions (mm)

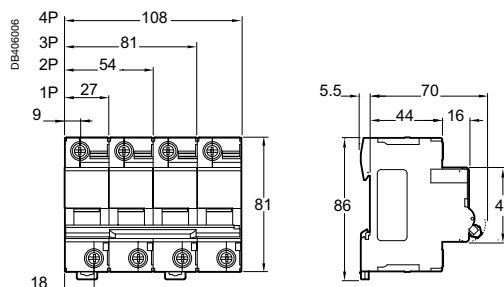

EN 61009

When a Vigi iC120 device is combined with a iC120 circuit breaker, it provides the following functions:

- protection of persons against electric shock by direct contact (30 mA),
- protection of persons against electric shock by indirect contact (≥ 300 mA),
- protection of installations against fire hazards (300 mA to 1000 mA).

PB107924-30



2P

PB107925-30





3P

PB107926-30



4P

Catalogue numbers

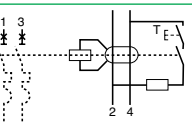
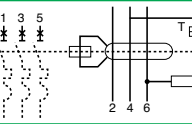
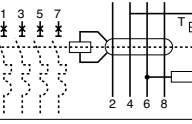
Vigi iC120 add-on residual current devices							
Type	AC 	Vigi iC120					Width in 9 mm modules
Product	Sensitivity	30 mA	300 mA	500 mA	300 mA 	1000 mA 	
 <p>dess. 077</p>		A9N18563	A9N18564	A9N18565	A9N18544	A9N18545	7
 <p>dess. 078</p>		A9N18566	A9N18567	A9N18568	A9N18546	A9N18547	10
 <p>dess. 078B</p>		A9N18569	A9N18570	A9N18571	A9N18548	A9N18549	10
Operating voltage (Ue)		230...415 V					
Operating frequency		50/60 Hz					



EN 61009



2P



3P



4P

When a Vigi iC120 device is combined with a iC120 circuit breaker, it provides the following functions:

- protection of persons against electric shock by direct contact (30 mA),
- protection of persons against electric shock by indirect contact (≥ 300 mA),
- protection of installations against fire hazards (300 mA to 1000 mA).

3

Catalogue numbers

Vigi iC120 add-on residual current devices									
Type	A	Vigi iC120						Width in 9 mm modules	
Product	Sensitivity	30 mA	300 mA	500 mA	300 mA	500 mA	1000 mA		
2P	Sensitivity	A9N18572	A9N18573	A9N18574	-	-	-	7	
3P	Sensitivity	A9N18575	A9N18576	A9N18577	-	-	-	10	
4P	Sensitivity	A9N18578	A9N18579	A9N18580	A9N18587	A9N18588	A9N18589	10	
Operating voltage (Ue)		230...415 V							
Operating frequency		50/60 Hz							



EN 61009



2P



3P



4P

When a Vigi iC120 device is combined with a iC120 circuit breaker, it provides the following functions:

- protection of persons against electric shock by direct contact (30 mA),
- protection of persons against electric shock by indirect contact (≥ 300 mA),
- protection of installations against fire hazards (300 mA to 1000 mA).

Special feature of type SI

They are appropriate for operating in environments with:

- high risk of unwanted tripping: frequent lightning strikes, IT system, presence of electronic ballasts, frequency converters, presence of switchgear incorporating lighting type interference filters, computer system, etc.
- blind sources:
 - presence of harmonics or high frequency rejections
 - presence of DC components: diodes, diode bridges, switch-mode power supplies, etc.
- protected against unwanted tripping caused by transient voltage surges (lightning strike, operation of switchgear on the network, etc.)

Catalogue numbers

Vigi iC120 add-on residual current devices							
Type		SI					Width in 9 mm modules
Product		Vigi iC120					
	Sensitivity	30 mA	300 mA	500 mA	300 mA	1000 mA	
<div style="display: flex; align-items: center;"> <div style="writing-mode: vertical-rl; transform: rotate(180deg); font-size: 8pt; margin-right: 5px;">dess. 077</div> </div>		A9N18591	A9N18592	-	A9N18556	A9N18557	7
<div style="display: flex; align-items: center;"> <div style="writing-mode: vertical-rl; transform: rotate(180deg); font-size: 8pt; margin-right: 5px;">dess. 079</div> </div>		A9N18594	A9N18595	-	A9N18558	A9N18559	10
<div style="display: flex; align-items: center;"> <div style="writing-mode: vertical-rl; transform: rotate(180deg); font-size: 8pt; margin-right: 5px;">dess. 078B</div> </div>		A9N18597	A9N18598	A9N18599	A9N18560	A9N18561	10
Operating voltage (Ue)		230...415 V					
Operating frequency		50/60 Hz					

Connection

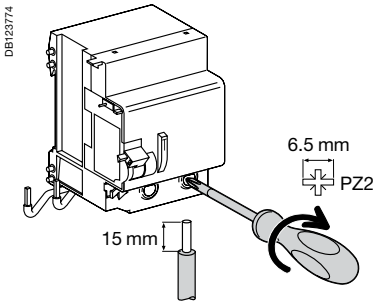

Type	Sensitivity	Tightening torque	Copper cables	
			Rigid	Flexible or with ferrule
Vigi iC120	30...1000 mA	3.5 N.m	1 to 50 mm ²	1 to 35 mm ²

3

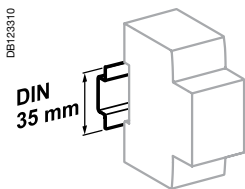

Clips onto 35 mm DIN rail.

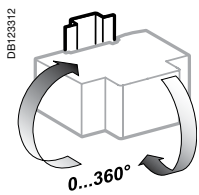

Any installation position.

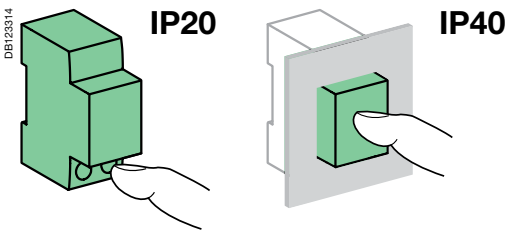

Technical data

Main characteristics

To IEC 60947-2

Insulation voltage (Ui)	500 V AC
Degree of pollution	3
Rated impulse withstand voltage (Uimp)	6 kV

To EN 61009

Impulse current withstand (8/20 μs) without tripping	Types AC and A (non-selective S)	250 Å
	Types AC and A (selective S)	3 kÅ
	Types SI (non-selective S)	3 kÅ
	Types SI (selective S)	5 kÅ

Additional characteristics

Degree of protection	Device only	IP20
	Device in a modular enclosure	IP40 Insulation class II
Operating temperature	Type AC	-5°C to +60°C
	Types A and SI	-25°C to +60°C
Storage temperature		-40°C to +85°C

Weight (g)

Add-on residual current devices

Type	Vigi iC120
2P	325
3P	500
4P	580

Dimensions (mm)

iC120 + Vigi iC120

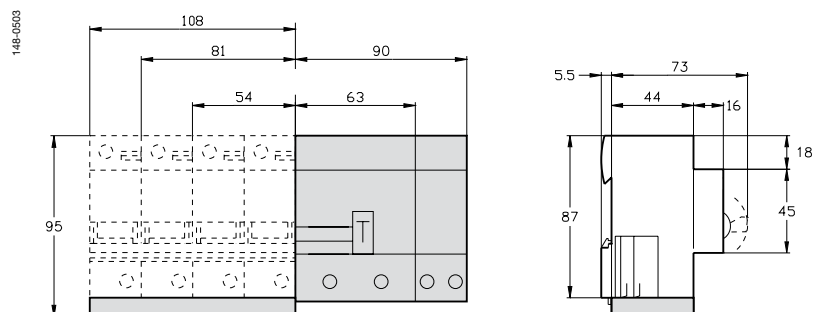

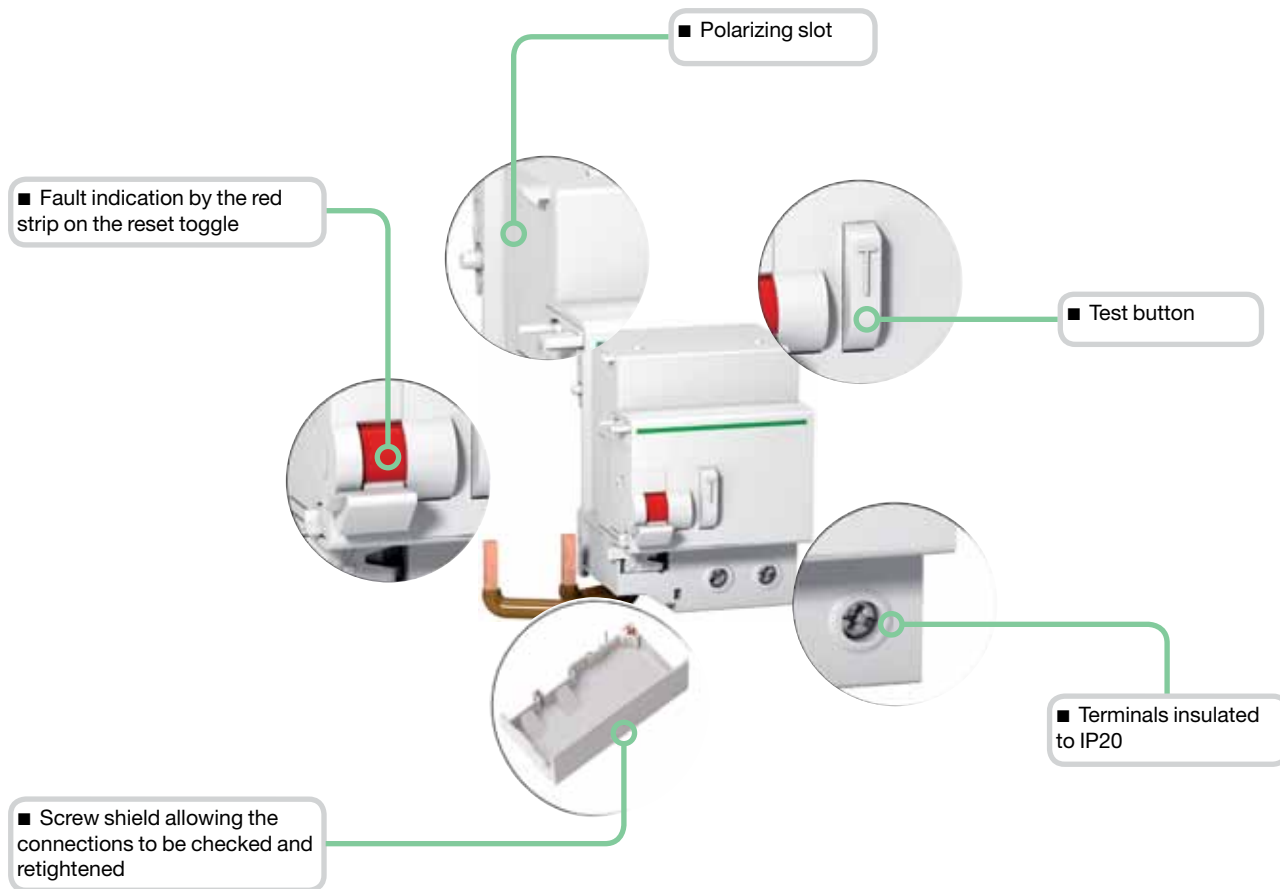



Type SI

The **SI** type provides increased immunity from electrical interference and polluted or corrosive environments.

Protection
Circuit protection
Earth leakage protection





Accessories for iC120, DPN, DPN Vigi,
C60H-DC, SW60-DC, C60NA-DC,
C60PV-DC, iSW devices

3

		Installation					
Accessories		Rotary handle		Plug-in base		Padlocking device	
							
Function		<p>Front or side control of 2, 3 and 4-pole circuit breakers</p> <ul style="list-style-type: none"> ■ Degree of protection: IP40 ■ A complete rotary handle consists of: <ul style="list-style-type: none"> □ a circuit-breaker operating sub-assembly, cat. no. 27046, □ a handle cat. no. 27047 or a handle cat. no. 27048 ■ Installation: <ul style="list-style-type: none"> □ the circuit-breaker operating sub-assembly cat. no. 27046 is fixed to the circuit breaker □ the removable handle cat. no. 27047 is mounted on the removable front panel or on the enclosure door □ the fixed handle cat. no. 27048 is fixed to the front or side panel of the enclosure 		<p>Allows a circuit breaker to be quickly removed or replaced, without touching the connections</p> <ul style="list-style-type: none"> ■ Degree of protection: IP20 ■ It consists of: <ul style="list-style-type: none"> □ a base to be fixed to a rail (or panel) □ 2 "blades" to be fixed in the device terminals ■ Connection: tunnel terminals for cables up to 50 mm² (rigid) or 35 mm² (flexible) ■ Installation: <ul style="list-style-type: none"> □ on backplate □ on a horizontal rail ■ Centreline between two rows: 200 mm ■ Only on the circuit breaker, without a Vigi device or auxiliary ■ Padlocking option (8 mm dia. padlock not supplied) 		<p>Used to padlock a circuit breaker in the "open" or "closed" position</p> <ul style="list-style-type: none"> ■ Diameter of the padlock: 8 mm max. ■ Locking in the ON position does not prevent the circuit breaker from tripping in the event of a fault ■ Isolation: in conformity with IEC/EN 60947-2. 	
Cat. numbers	27047 Removable extended handle	27048 Fixed handle	27046 Operating sub-assembly	26996 (1 per pole)	26997 (1 per pole)	27145	26970
Set of	1	1	1	1	1	4	2
Suitable for the following devices:							
iC120	■ 2P, 3P, 4P			–	■ ≤ 63 A	■	–
iC120 + Vigi iC120	■ 2P, 3P, 4P			–	–	■	–
DPN, DPN Vigi	■ 3P, 4P			–	–	–	■
C60H-DC	■ 2P			■	–	–	■
SW60-DC, C60NA-DC, C60PV-DC	–			–	–	–	■
iSW	■ iSW ≥ at 4 modules of 9 mm			■ iSW 40 to 63 A	–	–	■

Protection
Circuit protection
Earth leakage protection





Accessories for iC120, DPN, DPN Vigi,
C60H-DC, SW60-DC, C60NA-DC,
C60PV-DC, iSW devices (cont.)

Safety							
Accessories	Screw shield		Terminal shield			Interpole barrier	Spacer
066870_SE-33 	PB124114 		066889_SE-38 	DB123898 			PB104485-35 
Function	Prevents all contact with the fixing screws <ul style="list-style-type: none"> ■ The degree of protection becomes IP40 ■ Sealable, max. diameter 1.2 mm ■ Dividable 		Prevents all contact with the terminals <ul style="list-style-type: none"> ■ Degree of protection becomes IP40 ■ Sealable, max. diameter 1.2 mm <ul style="list-style-type: none"> ■ 1P ■ 1P ■ 2P ■ 3P: 1 x 26975 + 1 x 26976 ■ 4P: 2 x 26976 			Improves the insulation between the connections: cables, terminals, lugs, etc. <ul style="list-style-type: none"> ■ Used to: <ul style="list-style-type: none"> <input type="checkbox"/> complete the rows <input type="checkbox"/> separate the devices ■ Width: 1 x 9 mm module ■ Allows that 2 cables are routed from one row to another (above and below), up to 6 mm² 	
Cat. numbers	18527	26981	18526	26975	26976	27001	A9N27062
Set of	2 (4P dividable)		2 (for upstream/downstream terminal)			10	1
Suitable for the following devices:							
iC120	■	–	■	–	–	■	■
Vigi iC120	–	–	–	–	–	–	■
DPN, DPN Vigi	–	–	–	–	–	–	■
C60H-DC	–	■	–	■	■	■	■
SW60-DC, C60NA-DC, C60PV-DC	–	■	–	–	–	■	■
iSW	–	■ iSW 40 to 125 A	–	■ iSW 40 to 125 A	–	■ iSW 40 to 125 A	■

Protection
Circuit protection
Earth leakage protection

Accessories for iC120, DPN, DPN Vigi,
C60H-DC, SW60-DC, C60NA-DC,
C60PV-DC, iSW devices (cont.)

3

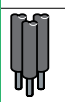
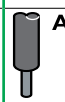
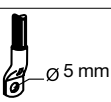
		Connection				
Accessories	Multi-cable terminal	50 mm ² Al terminal	Screw-on connection for ring terminal	Connection kit for ring terminals	Terminal for rear connector	
						
	DB118780	DB118782	DB123887	068887N-23	DB118784	
Function	<p>For 3 copper cables:</p> <ul style="list-style-type: none"> ■ Rigid up to 16 mm² ■ Flexible up to 10 mm² 	<p>For 16 to 50 mm² aluminium cables</p>	<p>For lug tipped cables, front or rear mounting</p>	<p>For terminal up to 63 A, front or rear access (screw Ø 5 mm)</p> <ul style="list-style-type: none"> ■ It incorporates a "conductive" part and an "insulating" part which ensures the phase-to-phase clearance 	<p>For cable up to 50 mm² or by terminal</p> <ul style="list-style-type: none"> ■ Supplied with a 1P terminal shield 	
						
	DB118787	DB123835	DB118789			
Cat. numbers	19091	19096	27060	27053	17400	18528
Set of	4	3	1	8	2	2
iC120	■	■	■	■	-	■
Vigi iC120	■	■	■	-	-	-
DPN, DPN Vigi	-	-	-	■	-	-
C60H-DC, iSW 40 to 125 A	■	■	■	■	■	-
SW60-DC, C60NA-DC	■	■	■	■	-	-
C60PV-DC	-	-	-	■	-	-
Tightening torque	2 N.m		10 N.m	2 N.m	-	-
Stripping length	11 mm		13 mm	-	-	-
Tools to be used	Diameter 5 mm or PZ2		Hc 1/5" or 5 mm	Diameter 5 mm	Diameter 5 mm	-

Identification																																									
Accessories	Clip-on terminal marker strip																																								
0312MD-SE-23																																									
Function	For connection identification																																								
Cat. numbers	<table border="1" style="width: 100%; border-collapse: collapse;"> <tbody> <tr> <td style="width: 25%;">0: AB1-R0</td> <td style="width: 25%;">A: AB1-GA</td> <td style="width: 25%;">K: AB1-GK</td> <td style="width: 25%;">U: AB1-GU</td> </tr> <tr> <td>1: AB1-R1</td> <td>B: AB1-GB</td> <td>L: AB1-GL</td> <td>V: AB1-GV</td> </tr> <tr> <td>2: AB1-R2</td> <td>C: AB1-GC</td> <td>M: AB1-GM</td> <td>W: AB1-GW</td> </tr> <tr> <td>3: AB1-R3</td> <td>D: AB1-GD</td> <td>N: AB1-GN</td> <td>X: AB1-GX</td> </tr> <tr> <td>4: AB1-R4</td> <td>E: AB1-GE</td> <td>O: AB1-GO</td> <td>Y: AB1-GY</td> </tr> <tr> <td>5: AB1-R5</td> <td>F: AB1-GF</td> <td>P: AB1-GP</td> <td>Z: AB1-GZ</td> </tr> <tr> <td>6: AB1-R6</td> <td>G: AB1-GG</td> <td>Q: AB1-GQ</td> <td>+: AB1-R12</td> </tr> <tr> <td>7: AB1-R7</td> <td>H: AB1-GH</td> <td>R: AB1-GR</td> <td>-: AB1-R13</td> </tr> <tr> <td>8: AB1-R8</td> <td>I: AB1-GI</td> <td>S: AB1-GS</td> <td>Blank : AB1-RV</td> </tr> <tr> <td>9: AB1-R9</td> <td>J: AB1-GJ</td> <td>T: AB1-GT</td> <td></td> </tr> </tbody> </table>	0: AB1-R0	A: AB1-GA	K: AB1-GK	U: AB1-GU	1: AB1-R1	B: AB1-GB	L: AB1-GL	V: AB1-GV	2: AB1-R2	C: AB1-GC	M: AB1-GM	W: AB1-GW	3: AB1-R3	D: AB1-GD	N: AB1-GN	X: AB1-GX	4: AB1-R4	E: AB1-GE	O: AB1-GO	Y: AB1-GY	5: AB1-R5	F: AB1-GF	P: AB1-GP	Z: AB1-GZ	6: AB1-R6	G: AB1-GG	Q: AB1-GQ	+: AB1-R12	7: AB1-R7	H: AB1-GH	R: AB1-GR	-: AB1-R13	8: AB1-R8	I: AB1-GI	S: AB1-GS	Blank : AB1-RV	9: AB1-R9	J: AB1-GJ	T: AB1-GT	
0: AB1-R0	A: AB1-GA	K: AB1-GK	U: AB1-GU																																						
1: AB1-R1	B: AB1-GB	L: AB1-GL	V: AB1-GV																																						
2: AB1-R2	C: AB1-GC	M: AB1-GM	W: AB1-GW																																						
3: AB1-R3	D: AB1-GD	N: AB1-GN	X: AB1-GX																																						
4: AB1-R4	E: AB1-GE	O: AB1-GO	Y: AB1-GY																																						
5: AB1-R5	F: AB1-GF	P: AB1-GP	Z: AB1-GZ																																						
6: AB1-R6	G: AB1-GG	Q: AB1-GQ	+: AB1-R12																																						
7: AB1-R7	H: AB1-GH	R: AB1-GR	-: AB1-R13																																						
8: AB1-R8	I: AB1-GI	S: AB1-GS	Blank : AB1-RV																																						
9: AB1-R9	J: AB1-GJ	T: AB1-GT																																							
Set of	250																																								
iC120	■ 4 markers max. per pole																																								
Vigi iC120	■ 4 markers max. per device																																								
DPN, DPN Vigi	■ 4 markers max. per pole																																								
C60H-DC, SW60-DC, C60NA-DC, C60PV-DC	■ 4 markers max. per pole																																								



Protection

Circuit protection

Earth leakage protection

Electrical auxiliaries for iC120, DPN, DPN Vigi, ID, C60H-DC, SW60-DC, C60PV-DC, C60NA-DC devices

3

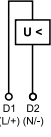
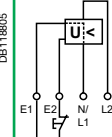
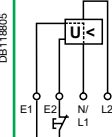

		Tripping					
Auxiliaries		MN		MNs		MNx	
Type		Undervoltage release					
		Instantaneous		Delayed		Independent of the supply voltage	
							
Function		<ul style="list-style-type: none"> Causes the device with which it is associated to trip when its input voltage decreases (between 70 % and 35 % of U_n). Prevents the device from closing until its input voltage has been restored 		<ul style="list-style-type: none"> No tripping in the event of transient voltage dips (up to 0.2 s) 		<ul style="list-style-type: none"> Tripping of the associated device by opening of the control circuit (e.g. push-button, dry contact) A drop in the supply voltage does not trip the associated device A locking push-button control allows the circuit protected (e.g. machine control) to be placed in safety configuration 	
Wiring diagrams							
Utilization		<ul style="list-style-type: none"> Emergency stop via a normally-closed pushbutton Ensures the safety of the power supply circuits of several machines by preventing accidental startups 				<ul style="list-style-type: none"> Fail-safe emergency stop Insensitive to the variation in the control circuit voltage to improve continuity of service Important: Before any servicing operation switch off the mains power supply (voltage presence at terminals E1/E2) 	
Catalogue numbers		A9N26960	A9N26961	A9N26959	A9N26963	A9N26969	A9N26971
iC120, DPN, DPN Vigi, ID		■	■	■	■	■	■
C60H-DC, SW60-DC, C60PV-DC, C60NA-DC		■	■	■	■	■	■
Technical specifications							
Rated voltage (U_e)	V AC	220...240	48	115	220...240	230	400
	V DC	-	48	-	-	-	-
Standardised operating and non-response to voltage times (U_a)*		-	-	-	-	-	-
Maximum operating time		-	-	-	-	-	-
Minimum non-response time		-	-	-	-	-	-
Operating frequency	Hz	50/60		400	50/60		50/60
Mechanical state indicator light, red		On front face			On front face		On front face
Test function		-			-		-
Width in 9 mm modules		2			2		2
Operating current		-			-		-
Number of contacts		-			-		-
Operating temperature	°C	-25...+50			-25...+50		-25...+50
Storage temperature	°C	-40...+85			-40...+85		-40...+85
Standards							
IEC/EN 60947-1		■		■		■	
IEC/EN 60947-5-1		-		-		-	
EN 60947-2		■		■		-	
EN 62019-2 ⁽¹⁾		-		-		-	

(1) For iC120, DPN.

*(U_a): Voltages measured between the phase and the neutral conductor, at which the MSU device must control the associated protective device.

Protection
Circuit protection
Earth leakage protection

Electrical auxiliaries for iC120, DPN,
DPN Vigi, ID, C60H-DC, SW60-DC,
C60PV-DC, C60NA-DC devices (cont.)

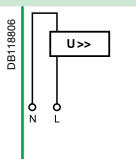
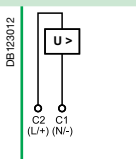
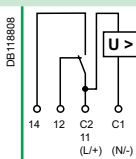
MSU					MX			MX+OF		
Voltage threshold release					Shunt release			With Open/Close auxiliary contact		
										
<p>■ Cuts off the power supply by opening the device with which it is associated when the phase/neutral voltage is exceeded (loss of neutral). For a four-phase network, use three MSU tripping auxiliaries</p>					<p>■ Trips the associated device when it is powered on</p>			<p>■ Includes an open/close contact (OF) to indicate the "open" or "closed" position of the breaker</p>		
										
<p>■ Protection of the devices against overvoltages on the electrical network (break in the neutral conductor) ■ Monitoring the voltage between the phase conductor and the neutral conductor</p>					<p>■ Emergency stop via a normally-open pushbutton.</p>			<p>■ Emergency stop via a normally-open pushbutton ■ Remote indication of the position of the associated device</p>		
A9N26500					A9N26476	A9N26477	A9N26478	A9N26946	A9N26947	A9N26948
■					■	■	■	■	■	■
-					■	■	■	■	■	■
230					100...415	48	12...24	100...415	48	12...24
-					110...130	48	12...24	110...130	48	12...24
255 V AC	275 V AC	300 V AC	350 V AC	400 V AC	-	-	-	-	-	-
No tripping	15 s	5 s	0.75 s	0.20 s	-	-	-	-	-	-
	3 s	1 s	0.25 s	0.07 s	-	-	-	-	-	-
50/60					50/60			50/60		
On front face					On front face			On front face		
-					-			-		
2					2			2		
-					-			3 A / 415 V AC 6 A / ≤ 240 V AC		
-					-			1 NO/NC		
-25...+50					-25...+50			-25...+50		
-40...+85					-40...+85			-40...+85		
■					■			■		
-					-			-		
-					-			-		
-					-			-		







Protection

Circuit protection

Earth leakage protection

Electrical auxiliaries for iC120, DPN, DPN Vigi, ID, C60H-DC, SW60-DC, C60PV-DC, C60NA-DC devices (cont.)

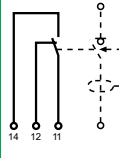
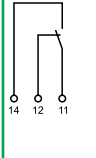
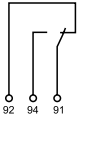
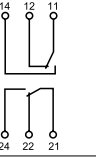
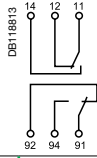
3

		Indication				
Auxiliaries		OF.S	OF	SD	OF+SD/OF	OF+SD24
Type		Open/closed auxiliary contact	Open/closed auxiliary contact	Fault indicating contact	Double open/closed or fault indicating contact	Double open/close and fault indicating contact
						 ComReady
Function		<ul style="list-style-type: none"> Changeover contact indicating the "open" or "closed" position of the associated device <p>⚠ Compulsory for the addition of tripping or indication auxiliaries on a residual current circuit breaker ID</p>	<ul style="list-style-type: none"> Changeover contact indicating the "open" or "closed" position of the associated device 	<ul style="list-style-type: none"> Changeover contact indicating the position of the associated device in the event of: <ul style="list-style-type: none"> electrical fault action on the tripping auxiliary <p>⚠ Not compatible with a ID residual current breaker, use an OF+SD/OF in the SD position</p>	<ul style="list-style-type: none"> The OF+SD/OF auxiliary is a two-in-one product: choice of OF + SD or OF + OF contact via the selector switch 	<ul style="list-style-type: none"> 2 contacts (1 NO + 1 NC) can report the signalling information of the associated device to the Acti 9 Smartlink or a programmable logic controller: <ul style="list-style-type: none"> electrical fault actuation of the tripping auxiliary "Open" or "Closed" position of the associated device
Wiring diagrams						 
					OF position	SD position
Utilization		<ul style="list-style-type: none"> Remote indication of the position of the associated device 	<ul style="list-style-type: none"> Remote indication of the position of the associated device 	<ul style="list-style-type: none"> Remote fault tripping indication of the associated device 	<ul style="list-style-type: none"> Remote position and/or fault tripping indication of the associated device 	<ul style="list-style-type: none"> Remote indication of position and tripping upon a fault of the associated breaker
Catalogue numbers		A9N26923	A9N26924	A9N26927	A9N26929	A9N26899
ID		■	■	■	■	■
iC120, DPN, DPN Vigi, C60H-DC, C60H-DC, SW60-DC, C60PV-DC, C60NA-DC		-	■	■	■	■
Technical specifications						
Rated voltage (Ue)	V AC	24...415	24...415	24...415	24...415	-
	V DC	24...130	24...130	24...130	24...130	24
Operating frequency	Hz	50/60	50/60	50/60	50/60	-
Mechanical state indicator		-	-	On front face	On front face	On front face
Test function		-	On front face	On front face	On front face	On toggle
Width in 9 mm modules		1	1	1	1	1
Operating current		3 A / 415 V AC 6 A / ≤ 240 V AC				2 mA mini, 100 mA maxi
Number of contacts		1 NO/NC	1 NO/NC	1 NO/NC	1 NO/NC + 1 NO/NC	1 NO + 1 NC
Operating temperature	°C	-25...+50	-25...+50	-25...+50	-25...+50	-25...+70
Storage temperature	°C	-40...+85	-40...+85	-40...+85	-40...+85	-40...+85
Standards						
IEC/EN 60947-1		-	-	-	-	-
IEC/EN 60947-5-1		■	■	■	■	■ IEC 60947-5-4
EN 60947-2		-	-	-	-	-
EN 62019-2 ⁽¹⁾		■	■	■	■	-

(1) For iC120, DPN.

Protection
Circuit protection
Earth leakage protection

Electrical auxiliaries for iC120, DPN, DPN Vigi, ID, C60H-DC, SW60-DC, C60PV-DC, C60NA-DC devices (cont.)

Connection

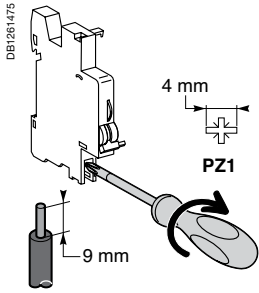

Type	Tightening torque	Copper cables	
		Rigid	Flexible or with ferrule
Indication and tripping auxiliaries	1 N.m	0.5 to 2.5 mm ²	2 x 1.5 mm ²

Ti24 connector connection

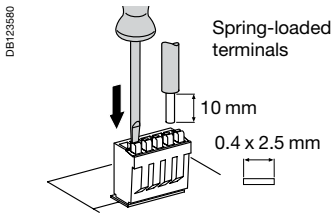

Type	Catalogue numbers	Copper cables	
		Rigid	Flexible
Ti24 interface	A9XC2412	1 x 0.5 to 1.5 mm ²	1 x 0.5 to 1.5 mm ²

Ti24 prefabricated cables connection

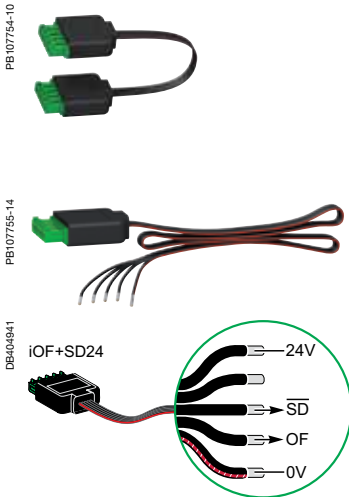

Type	Cat. no.	Length
Connection for Acti 9 Smartlink		
6 short prefabricated	A9XCAS06	100 mm
6 medium-sized prefabricated	A9XCAM06	160 mm
6 long prefabricated	A9XCAL06	870 mm
Connection for PLC type terminals		
6 long prefabricated on a single side	A9XCAU06	870 mm

Weight (g)

Electrical auxiliaries	
Type	Weight (g)
MN	66
MNs	66
MNx	73
MSU	66
MX	60
MX+OF	65
OF.S	33
OF	30
SD	30
OF+SD/OF	38
OF+SD24	28

Dimensions (mm)

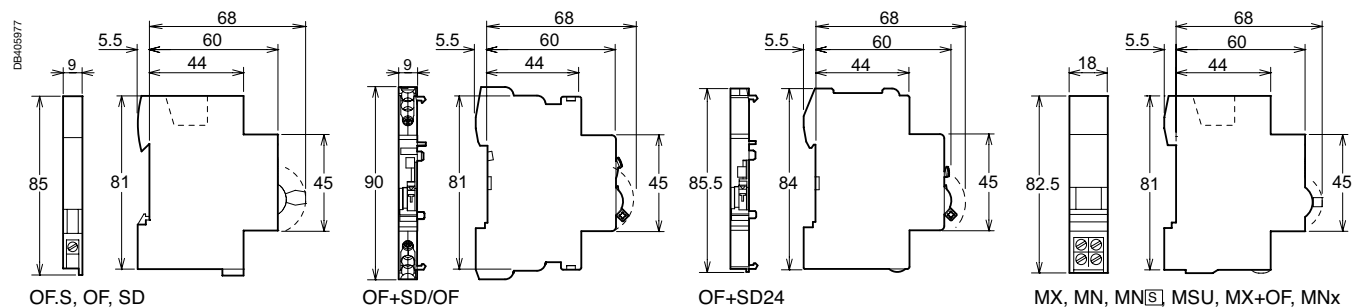

Load protection Motor starter protection

P25M

3



IEC 60947-2 and IEC 60947-4-1 (in combination)

They protect single-phase or three-phase motors with manual local control. This protection includes:

- isolation
- manual or remote control
- short-circuit protection (magnetic)
- overload protection (thermal).

Breaking capacity to IEC 60947-2

Rating (A)	Voltage (V)													
	230...240		400...415		440		500		690					
	Icu kA	Ics %	Icu kA	Ics %	Icu kA	Ics %	Icu kA	Ics %	Icu kA	Ics %				
0.16 to 1.6	Unlimited								3	75				
2.5									3	75				
4									3	75				
6.3									50	100	50	100	3	75
10									15	100	10	100	3	75
14	15	50	8	50	6	75	3	75						
18	15	50	8	50	6	75	3	75						
23	50	100	15	40	6	50	4	75	3	75				
25	50	100	15	40	6	50	4	75	3	75				

The limiting unit increases the breaking capacity up to 100 kA at 415 V.

Catalogue numbers

Type	Motor characteristics						P25M circuit breaker				
	Standardised power (kW) of three-phase 50/60 Hz motors in category AC3 Voltage (V AC)						Rating In (A)	Setting	Cat. no.	Width in 9 mm modules	
	230	400	415	440	500	690					
3P	-	-	-	-	-	-	0.16	0.1-0.16	21100	5	
	-	-	-	-	-	-	0.25	0.16-0.25	21101	5	
	-	-	-	-	-	-	0.40	0.25-0.40	21102	5	
	-	-	-	-	-	0.37	0.63	0.40-0.63	21103	5	
	-	-	-	0.37	0.37	0.55	1.0	0.63-1	21104	5	
	-	0.37	-	0.55	0.75	1.1	1.6	1-1.6	21105	5	
	0.37	0.75	1.1	1.1	1.1	1.5	2.5	1.6-2.5	21106	5	
	0.75	1.5	1.5	1.5	2.2	3	4.0	2.5-4	21107	5	
	1.1	2.2	2.2	3	3.7	4	6.3	4-6.3	21108	5	
	2.2	4	4	4	5.5	7.5	10	6-10	21109	5	
	3	5.5	5.5	7.5	9	11	14	9-14	21110	5	
	4	7.5	9	9	10	15	18	13-18	21111	5	
	5.5	9	11	11	11	18.5	23	17-23	21112	5	
	5.5	11	11	11	15	22	25	20-25	21113	5	



Limiting unit

Type	Rating In (A)	Cat. no.	Width in 9 mm modules
3P	63	21115	5

(1) The neutral pole comes equipped with a locked tube.

Load protection Motor starter protection

P25M (cont.)

Connection

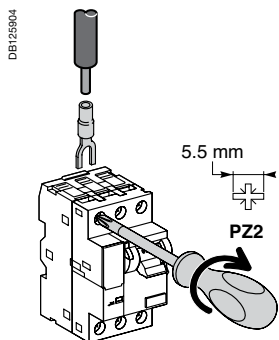

P25M

Tightening torque	Terminal clamps		With insulated connector	Limiting unit
	Rigid Cu	Flexible Cu	Flexible Cu	Tunnel terminals Flexible or rigid Cu
1.7 N.m.				
	2 x 1 ... 6 mm ²		2 x 1.5 ... 6 mm ²	1 x 25 mm ² or 2 x 10 mm ²

3

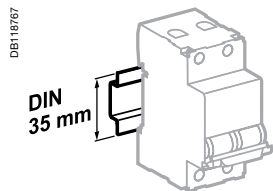

Mounted on 35 mm DIN rail.

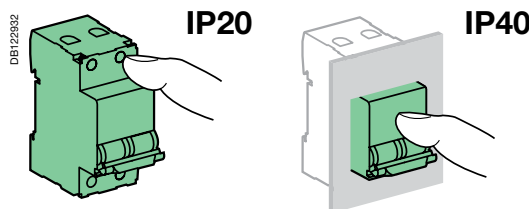
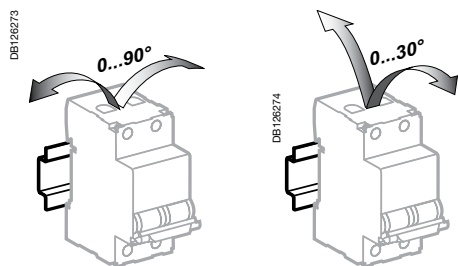

Weight (g)

P25M	260
Limiting unit	130

Technical data

Electrical characteristics

Operating voltage (Ue)	690 V AC
Insulation voltage (Ui)	690 V
Rated impulse withstand voltage (Uimp)	6 kV
Endurance (O-C)	Electrical AC3
Thermal trip unit	100,000 cycles
Settings	Sensitive to missing phase
	Factory < settings range
	Simultaneously on the front face
	On current drawn in nominal operation
Ratings (In)	0.16 to 25 A adjustable
Temperature compensation	-20°C to +40 °C in an enclosure
Magnetic trip unit	12 x the In rating (±20 %)

Other characteristics

Padlocking device on the front face	
Tropicalisation	Treatment 2 (relative humidity 95 % at 55°C)
Operating temperature	-20 ...+60°C
Storage temperature	-40 ...+80°C

Rated operating current (Ie) of auxiliary contacts under the rated operating voltage (Ue)

Operating voltage (Ue)		Operating current			
(V AC)	(V DC)	Position contact		fault tripping contact	
		AC 15 (A AC)	DC 13 (A DC)	AC 14 (A AC)	DC 13 (A DC)
415	220	2.2	0.5	-	-
240	110	3.3	1.3	-	-
130	60	4.5	3	0.5	0.15
48	48	6	5	1	0.3
24	24	-	6	1.5	1

Dimensions (mm)

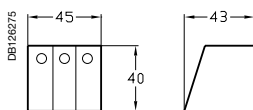
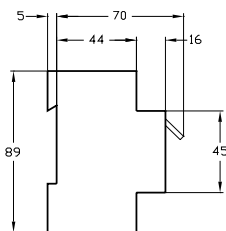
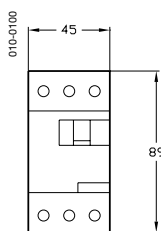

Limiting unit only

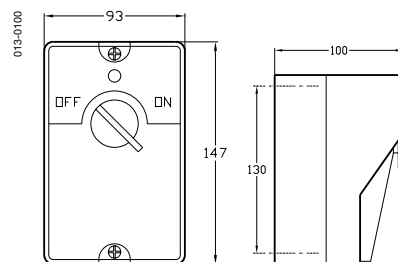

Insulating enclosure

Connection

Cables			
	Rigid	Flexible	Flexible with ferrule
Mini	1 x 1 to 2.5 mm ²	1 x 0.75 to 2.5 mm ²	1 x 0.75 to 1.5 mm ²
Maxi	2 x 1 to 2.5 mm ²	2 x 0.75 to 2.5 mm ²	2 x 0.75 to 1.5 mm ²
Tightening torque	1.4 N.m		

The electrical auxiliaries allow remote tripping or position or fault indication of the PM25 circuit breakers.

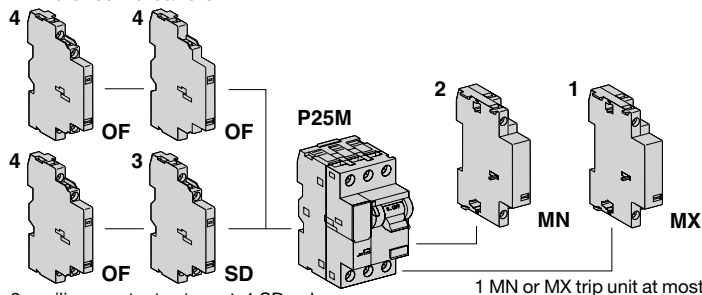

2 auxiliary contacts at most, 1 SD only.
SD is always mounted next to the P25M.

3

Catalogue numbers

Trip units

Type	Control voltage (V AC)	Width in 9 mm modules	Cat. no.
1 MX shunt release			
<ul style="list-style-type: none"> Emergency stoppage by normally open push button Causes tripping of the associated device when powered 	220...240	2	21127
	380...415	2	21128
2 MN undervoltage release			
<ul style="list-style-type: none"> Emergency stoppage by normally closed push button Ensures the safety of power supply circuits for several machines by preventing untimely restarting Causes tripping of the circuit breaker with which it is associated when its input voltage decreases (between 70% and 35% of Un) Prevents closing of the device until its input voltage has been restored 	220...240	2	21129
	380...415	2	21130

Auxiliary contacts

Type	Width in 9 mm modules	Cat. no.
3 Position and fault tripping indication contacts		
F + SD.F	1	21118
O + SD.F	1	21119
F + SD.O	1	21120
O + SD.O	1	21121
4 Position contacts		
O + F	1	21117
F + F	1	21116

"O ": normally closed contact
 "F ": normally open contact
 SD: contact indicating the position of the associated device in the event of an electrical fault
 SD.F: to indicate a closed contact fault
 SD.O: to indicate an open contact fault

Accessories make it easier to integrate the circuit breakers and extend their use.

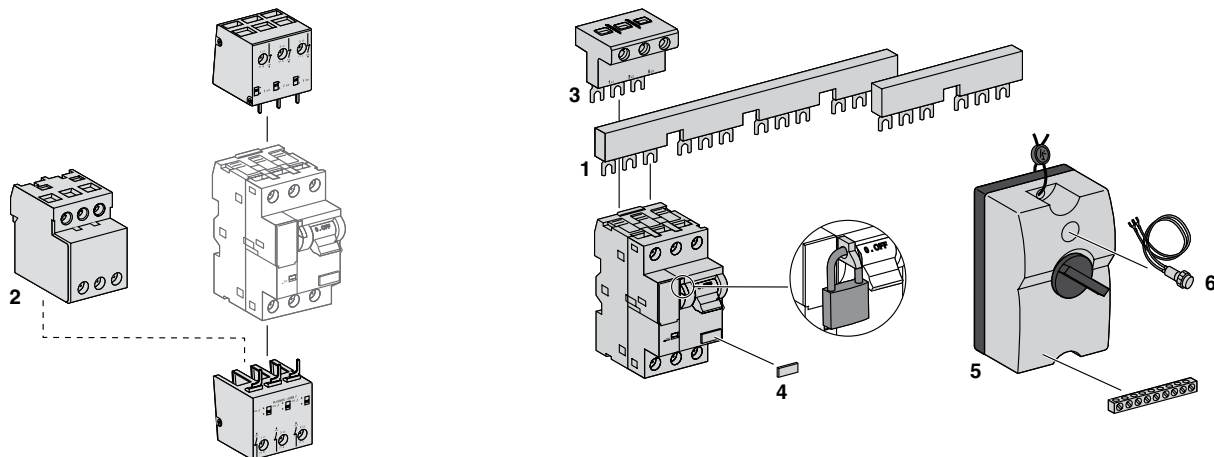

Catalogue numbers

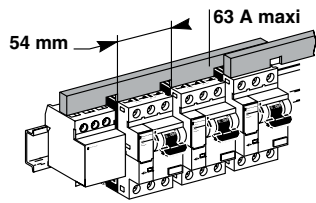
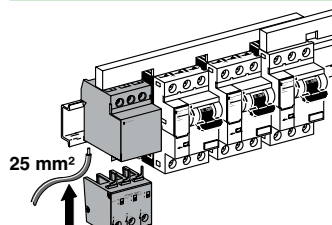
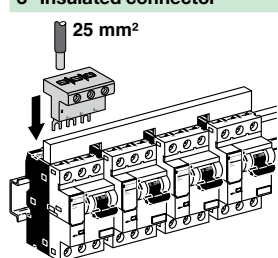
	Type	Cat. no.
1 Comb busbars 	2 P25M feeders	GV2G254
	4 P25M feeders	GV2G454
	Protection end-piece	GV2G10
2 Downstream terminal block 		GV2G05+LA9E07
	GV2G05: Downstream terminal block LA9E07: Cover for downstream terminal block	
3 Insulated connector 		GV2G09
4 Clip-on terminal markers	see module CM907003E	
5 Insulating enclosure Individual installation of a P25M circuit breaker with an auxiliary contact block and trip unit. Double insulation and sealed to IP55. L = 93, H = 147, P = 100 (mm)		21133
6 Neon indicator light 230-240 V AC 400-415 V AC	Green	GV2SN23
	Red	GV2SN24
	Green	GV2SN33
	Red	GV2SN34

Surge arresters **pages 4/2 to 4/7**
iPRF1 12.5r/PRF1 Master/PRD1 25r/PRD1 Master
Type 1 and 2 LV pages 4/2 to 4/6
Features..... page 4/7

Withdrawable surge arresters **pages 4/8 to 4/17**
iPRD Type 2 or 3 LV pages 4/8 to 4/11
iQuick PRD Type 2 or Type 3 pages 4/12 to 4/14
iPRD-DC Type 2 for photovoltaic applications pages 4/15 to 4/17

Surge protection kits **page 4/18**

Protection

Load protection

iPRF1 12.5r/PRF1 Master/ PRD1 25r/PRD1 Master

Type 1 and 2 LV surge arresters

The Type 1 range of surge arresters meets the normative withstand capability of current wave type 10/350 μ s (8/20 μ s for Type 2 surge arresters). It is suitable for use with TT, TN-S, TN-C and 230 V IT earthing connection systems (neutral point connection). In addition, the PRF1 Master surge arrester covers the 400 V IT system.

iPRF1 12.5r and PRD1 surge arresters are fitted with a remote transfer contact to send "end-of-life indication" information.

PRD1 surge arresters are fitted with easy-to-replace withdrawable cartridges.

iPRF1 12.5r/PRF1 Master/PRD1 25r/PRD1 Master

The Type 1 surge arrester is recommended for electrical installations in the service sector and industrial buildings protected by a lightning conductor or by a meshed cage.

It protects electrical installations against direct lightning strikes.

It is used to conduct the direct lightning current, propagating from the earth conductor to the network conductors.

It must be installed with an upstream disconnection device, such as a fuse or circuit-breaker, whose breaking capacity must be at least equal to the maximum prospective short-circuit current at the installation point.

iPRF1 12.5r and PRD1 25r surge arresters also provide Type 2 protection and protect the electrical installation by finely clipping the lightning wave overvoltages.

4

PB104275-35



iPRF1 12.5r

PB104280-35



PRD1 25r

PB104284-35



PRD1 Master

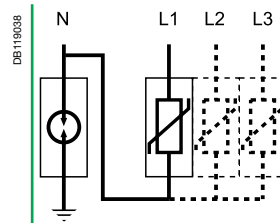

iPRF1 12.5r (1P+N, 3P+N)

Type	Product solution	
Fixed surge arrester	1P+N	3P+N
iPRF1 12.5r T1, T2	A9L16632	A9L16634

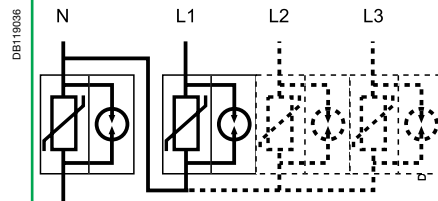

PRD1 25r (1P+N, 3P+N)

Cartridge surge arrester	1P+N	3P+N
PRD1 25r T1 + T2	16330	16332
PRD1 Master T1	16361	16363

	Neutral point connection
	TT, TN-S
	TT, TN-S
	TT, TN-S

(1) Version without indicator light.

Type	Nb. of poles	Width	I imp (kA) (10/350) Impulse current		I max (kA) (8/20) Maximal discharge current	In - kA Rated discharge current	Up - kV Degree of protection	Un - V Nominal line voltage	Uc - V Maximum steady state voltage	
Fixed surge arrester		9 mm modules	Surge arrester	Surge arrester + disconnecter						
iPRF1 12.5r	Type 1 + 2									
	1P+N	4	12.5/50 N/PE		50	25	1.5	230	350	A9L16632
	3P+N	8	12.5/50 N/PE		50	25	1.5	230 / 400	350	A9L16634
Withdrawable surge arrester										
PRD1 25r	Type 1 + 2									
	1P+N	8	25/100 N/PE		40	25	1.5	230/400	350	16330
	3P+N	16	25/100 N/PE		40	25	1.5	230/400	350	16332
PRD1 Master	Type 1									
	1P+N	8	25/100 N/PE		-	25	1.5	230/400	350	16361
	3P+N	16	25/100 N/PE		-	25	1.5	230/400	350	16363
Spare cartridge										
C1 Master-350	-	4	-	-	-	25	1.5	-	350	16314
C1 25-350	-	23 mm	-	-	-	25	1.5	-	350	16315
C2 40-350	-	12 mm	-	-	-	20	1.4	-	350	16316
C1 Neutral-350	-	4	-	-	-	-	-	-	350	16317

4

Surge arresters	Spare cartridge		
	Phase		Neutral
	Type 1	Type 2	
PRD1 25r			
PRD1 25r 1P+N	16315	16316	16317
PRD1 25r 3P	3 x 16315	3 x 16316	-
PRD1 Master			
PRD1 Master 1P+N	16314	-	16317
PRD1 Master 3P+N	3 x 16314	-	16317

DB123370



Accessories		
Type	Number of poles	
4P Wiring comb busbars	4	16643
6P Wiring comb busbars	6	16644
8P Wiring comb busbars	8	16645
200 mm flexible cable (PRF1 Master)		16646

Technical data

		iPRF1 12.5r	PRF1 Master	PRD1 25r	PRD1 Master
Operating frequency		50 Hz	50/60 Hz	50 Hz	50 Hz
Degree of protection	Front panel	IP40	IP40	IP40	IP40
	Terminals	IP20	IP20	IP20	IP20
	Impacts	IK05	IK05	IK05	IK05
Response time		≤ 25 ns	≤ 1 μs	≤ 25 ns	≤ 100 ns
End-of-life indication		Green: correct operation	-	White: correct operation	White: correct operation
		Red: at end of life	-	Red: at end of life	Red: at end of life
	Remote notification	1.5 A/250 V AC	-	1 A/250 V AC. 0.2 A/125 V DC	1 A/250 V AC. 0.2 A/125 V DC
By tunnel terminal	Rigid cable	10...35 mm ²	10...50 mm ²	2.5...35 mm ²	10...35 mm ²
	Flexible cable	10...25 mm ²	10...35 mm ²	2.5...25 mm ²	10...25 mm ²
Operating temperature		-25°C to +60°C	-40°C to +85°C	-25°C to +60°C	-25°C to +60°C
Standards	Type 1	IEC 61643-1 [T1], EN 61643-11 Type 1	IEC 61643-1 [T1], EN 61643-11 Type 1	IEC 61643-1 [T1], EN 61643-11 Type 1	IEC 61643-1 [T1], EN 61643-11 Type 1
	Type 2	IEC 61643-1 [T2], EN 61643-11 Type 2	-	IEC 61643-1 [T2], EN 61643-11 Type 2	-
Certification		CE	KEMAKEUR, CE	KEMAKEUR, CE	CE

Choice of disconnecter (maximum current rating) / surge arrester

Type	I _{imp} : impulse current	I _{sc} : prospective short-circuit current at the installation point				
		10 kA	15 kA	25 kA	36 kA	50 kA
iPRF1 12.5r	12.5 kA	C120H 80 A curve C or NG125N 80 A curve C	NG125N 80 A curve C	NG125H 80 A curve C	NG125L 80 A curve C	
PRF1 Master	35 kA	Compact NSX160B 160 A TM		Compact NSX160F 160 A	Compact NSX160N 160 A	
PRD1 25r	25 kA	NG125N 80 A curve C		-		
PRD1 Master	25 kA	NG125N 80 A curve C		NG125H 80 A curve C	NG125L 80 A curve C	

Dimensions (mm)

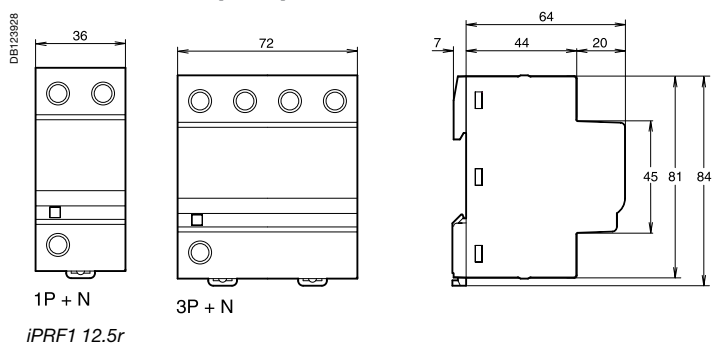

4

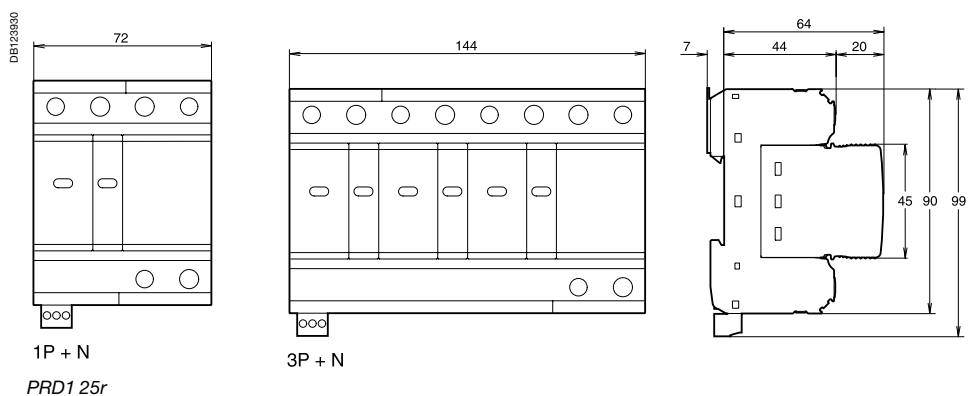
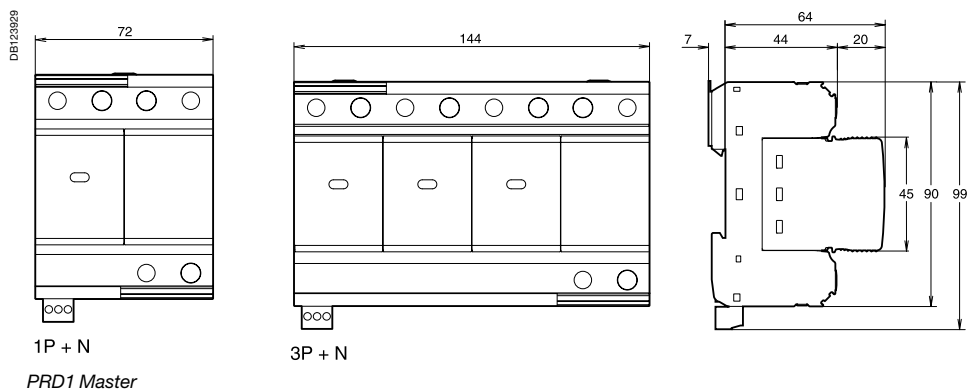

iPRD surge arresters

PE110281-60



Terminals
■ IP20

Satisfactory operation indication
■ By mechanical indicator
□ white: operating
□ red: cartridge must be replaced

■ Transfer to Acti 9 Smartlink



Connection iPRD surge arrester with its short circuit disconnecter

TT / TN-S
Power supply through the top
Connection with cables

PE110285-50



Surge arrester iPRD 3P+N + iC60H 3P+N

Reversible
■ The surge arrester base can be turned over to allow the phase/neutral/earth cables to enter through either the top or the bottom

TT / TN-S
Power supply through the bottom
Connection with comb busbar

PE110793-50



Surge arrester iPRD 3P+N + iC60H 3P+N

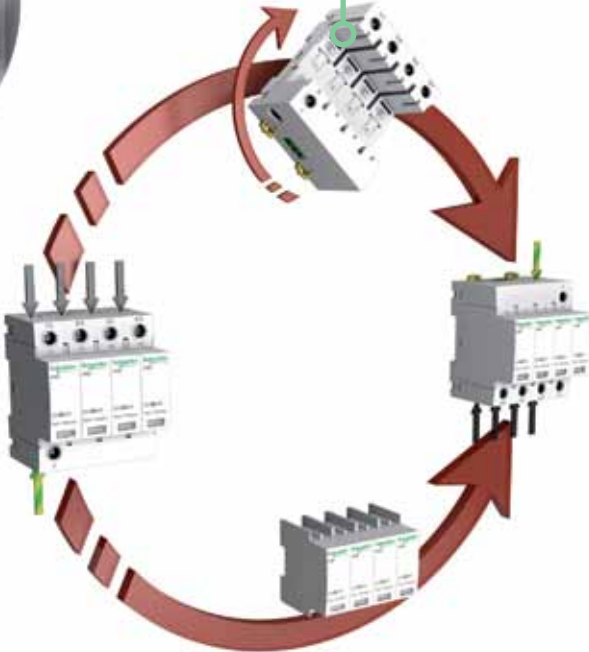

PE110287-80

Surge arrester iPRD 4P + iC60N 4P



iPRD withdrawable surge arresters allow quick replacement of damaged cartridges.
 Type 2 surge arresters are tested with a 8/20 μ s current wave.
 Type 3 surge arresters are tested with a 1.2/50 μ s and 8/20 μ s combined wave.

Each surge arrester in the range has a specific application:

- **incoming protection (type 2):**
 - the iPRD65r is recommended for a very high risk level (strongly exposed site)
 - the iPRD40(r) is recommended for a high risk level
 - the iPRD20(r) is recommended for a medium risk level
- **secondary protection (type 2 or 3):**
 - the iPRD8(r) ensures secondary protection of loads to be protected and is placed in cascade with the incoming surge arresters. This surge arrester is required when the loads to be protected are at a distance of more than 10 m from the incoming surge arrester.

The iPRD surge arresters with “r” indication have remote transfer of the information: “cartridge to be replaced”.

4



2P



4P

Catalogue number iPRD surge arresters

Rated discharge current (Imax)	Nominal discharge current (In)	Type of protection		Network	
		Incoming	Secondary	1P+N	3P+N
iPRD65					
65 kA Very high risk level (strongly exposed site)	20 kA	iPRD65		A9L65501	A9L65601
iPRD40					
40 kA High risk level	15 kA	iPRD40		A9L40501 A9L40500	A9L40601 A9L40600
iPRD20					
20 kA Medium risk level	5 kA	iPRD20		A9L20501 A9L20500	A9L20601 A9L20600
iPRD8					
8 kA Secondary protection: placed near the loads to be protected when they are at a distance of more than 10 m from the incoming surge arrester	2.5 kA		iPRD8	A9L08501 A9L08500	A9L08601 A9L08600



Cartridge

Spare cartridges iPRD		
Type	Spare cartridges for	Cat. no
iPRD 65-350	iPRD65r	A9L65102
iPRD 40-350	iPRD40, iPRD40r	A9L40102
iPRD 20-350	iPRD20, iPRD20r	A9L20102
iPRD 8-350	iPRD8, iPRD8r	A9L08102
iPRD Neutral	All products (1P+N, 3P+N)	A9L00002

	Earthing system	Transfer	Surge arrester name	Width in mod. of 9 mm	Up - (kV) Voltage protection level			Un - (V) Rated voltage network	Uc - (V) Maximum continuous operating voltage		
					CM*		DM*		CM*		DM*
					L/⊥	N/⊥	L/N		L/⊥	N/⊥	L/N
iPRD65											
	TT & TN-S	■	iPRD65r 1P+N	4	-	≤ 1.4	≤ 1.5	230	-	260	350
	TT & TN-S	■	iPRD65r 3P+N	8	-	≤ 1.4	≤ 1.5	230/400	-	260	350
iPRD40											
	TT & TN-S	■	iPRD40r 1P+N	4	-	≤ 1.4	≤ 1.6	230	-	260	350
	TT & TN-S		iPRD40 1P+N		-	≤ 1.4	≤ 1.6		-	260	350
	TT & TN-S	■	iPRD40r 3P+N	8	-	≤ 1.4	≤ 1.6	230/400	-	260	350
	TT & TN-S		iPRD40 3P+N		-	≤ 1.4	≤ 1.6		-	260	350
iPRD20											
	TT & TN-S	■	iPRD20r 1P+N	4	-	≤ 1.4	≤ 1.2	230	-	260	350
	TT & TN-S		iPRD20 1P+N		-	≤ 1.4	≤ 1.2		-	260	350
	TT & TN-S	■	iPRD20r 3P+N	8	-	≤ 1.4	≤ 1.2	230/400	-	260	350
	TT & TN-S		iPRD20 3P+N		-	≤ 1.4	≤ 1.2		-	260	350
iPRD8 (1) Type 2 / Type 3 (1)											
	TT & TN-S	■	iPRD8r 1P+N	4	-	≤ 1.4	≤ 1.2	230	-	260	350
	TT & TN-S		iPRD8 1P+N		-	≤ 1.4	≤ 1.2		-	260	350
	TT & TN-S	■	iPRD8r 3P+N	8	-	≤ 1.4	≤ 1.2	230/400	-	260	350
	TT & TN-S		iPRD8 3P+N		-	≤ 1.4	≤ 1.2		-	260	350

* **CM**: common mode (phase to earth and neutral to earth). * **DM**: differential mode (phase to neutral). **(1) Uoc**: combined waveform voltage: 10 kV.

Connection

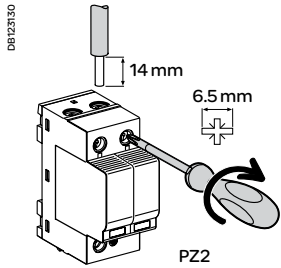

Type	Tightening torque	Copper cables	
		Rigid	Flexible or with ferrule
iPRD	3.5 N.m	2.5 to 25 mm ²	4 to 16 mm ²

4

Technical data

Main characteristics

Operating frequency		50/60 Hz
Operating voltage (U _e)		230/400 V AC ±10 %
Permanent operating current (I _c)		< 1 mA
Response time		< 25 ns
Short circuit withstand (I _{sc})		50 kA (50 Hz)
Temporary overvoltage withstand (U _T)	U _T (L-N)	337 V AC / 5 s
	U _T (L-PE)	442 V AC / 5 s
Temporary overvoltage Safe failure mode (U _T)	U _T (N-PE)	1200 V AC / 200 ms
	U _T (L-PE)	1453 V AC / 200 ms
	I _{PE} (N-PE)	3 µA for 1P+N, 3P+N
Satisfactory operation indication: by mechanical indicator	White	In operation
	Red	Cartridge must be replaced
Remote indication of satisfactory operation		By contact NO, NC 250 V / 0.25 A

Additional characteristics

Degree of protection (IEC 60529)	Device only	IP20 (built-in)
	Device in modular enclosure	IP40
Operating temperature		-25°C to +60°C
Humidity range		5 % to 95 %
Type of connection terminals		Tunnel terminals, 2.5 to 35 mm ²
Standards		IEC 61643-11: 2011 $\overline{T2}$, $\overline{T3}$ and EN 61643-11: 2012 Type 2, Type 3

Surge arrester/circuit breaker association

Type of surge arrester	Associated circuit breaker (1 to 4 poles protected)
iPRD65	Curve C 50 A
iPRD40	Curve C 40 A
iPRD20	Curve C 25 A
iPRD8	Curve C 20 A

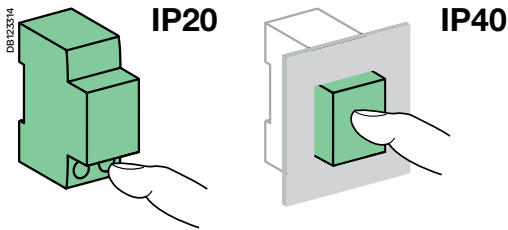

Weight (g)

Surge arrester	
Type	iPRD
1P+N	220
3P+N	450

Dimensions (mm)

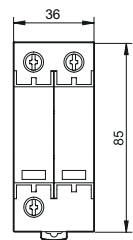

1P+N

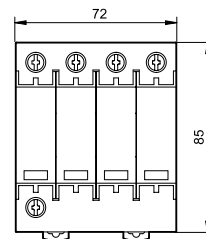

3P+N

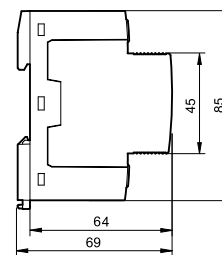

Surge protection Load protection

Withdrawable surge arrester iQuick PRD Type 2 or Type 3

Withdrawable surge arrester iQuick PRD allow damaged cartridges to be replaced quickly. They offer remote reporting of the "cartridge must be changed" message.



PB106430-29

IEC 61643- 1 **T2**, EN 61643-11 Type 2

They protect electrical and electronic equipment against lightning-induced surges. Withdrawable surge arrester iQuick PRD surge arresters are prewired, incorporating their end-of-life disconnecter.

Each surge arrester in the range has a specific use:

■ **incoming protection (type 2):**

- iQuick PRD40r is recommended for a high risk level
- iQuick PRD20r is recommended for a moderate risk level

■ **secondary protection (type 2 or 3):**

- iQuick PRD8r provides secondary protection for the loads to be protected and is cascade-mounted with the incoming surge arresters. This surge arrester is required as close as possible to the loads to be protected when they are located more than 30 metres away from the incoming surge arrester.

4



PB106428-29



DE123837

Replacement cartridges.

Maximum discharge current (Imax) / Nominal discharge current (In)	Type of protection		Network	
	Incoming protection	Secondary protection	1P+N	3P+N
40 kA / 20 kA				
High risk level	iQuick PRD40r		A9L16292	A9L16294
20 kA / 5 kA				
Moderate risk level	iQuick PRD20r		A9L16295	A9L16297
8 kA / 2 kA				
Secondary protection: placed near the loads to be protected when they are at a distance of more than 30 m from the incoming surge arrester		iQuick PRD8r	A9L16298	A9L16300

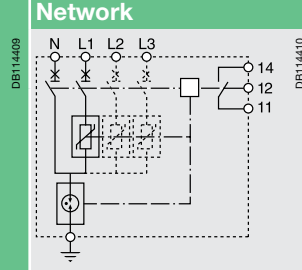

Replacement cartridges		
Type	Replacement cartridges for	Cat. no.
C 40-350	iQuick PRD40r	A9L16310
C 20-350	iQuick PRD20r	A9L16311
C 8-350	iQuick PRD8r	A9L16312
C neutral-350	All products	A9L16313

Surge protection Load protection

Withdrawable surge arrester iQuick PRD Type 2 or Type 3 (cont.)

Connection

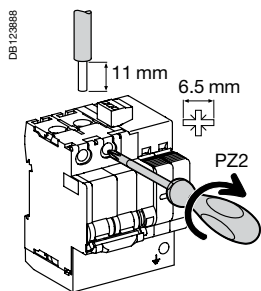

Type	Tightening torque	Copper cables	
		Rigid	Flexible or ferrule
iQuick PRD Ph / N 8r/20r Ph / N 40r ⊥	2.5 N.m		
		2.5 to 25 mm ²	2.5 to 25 mm ²
		2.5 to 35 mm ² 25 mm ² max.	2.5 to 35 mm ² 25 mm ² max.

Earthing system	Transfert	Name of surge arrester	Width in 9 mm modules	Up – (kV) Voltage protection level			Un – (V) Nominal mains voltage	Uc – (V) Maximum continuous operating voltage		
				CM*		DM*		CM*		DM*
				L/⊥	N/⊥	L/N		L/⊥	N/⊥	L/N
iQuick PRD40r										
TT & TN-S	■	1P+N	8	1.5	1.5	2.5	230	-	264	350
TT & TN-S	■	3P+N	15	1.5	1.5	2.5	230/400	-	264	350
iQuick PRD20r										
TT & TN-S	■	1P+N	8	1.5	1.5	1.5	230	-	264	350
TT & TN-S	■	3P+N	15	1.5	1.5	1.5	230/400	-	264	350
iQuick PRD8r (2) Type 2 / Type 3										
TT & TN-S	■	1P+N	8	1.5/1.4	1.5/1.5	1.2/1.4	230	-	264	350
TT & TN-S	■	3P+N	15	1.5/1.4	1.5/1.5	1.2/1.4	230/400	-	264	350

* **CM** common mode (between phase/earth and neutral/earth). * **DM**: differential mode (between phase and neutral).
(1) Up (MCB + SPD): total value measured between Modular Circuit Breaker (MCB) terminal block and PE surge arrester device terminal block (SPD).
(2) Uoc: open-circuit voltage in combined wave: 10 kV.



Pragma: the earth terminal block needs 1 support kit and 1 terminal block kit.

Accessories

Earth terminal block support			
Type			Cat. no.
Support kit		L = 4 blocks Batch of 1	PRA90053
25 mm ² terminal block kit		L = 1 block Batch of 5	PRA90046

Surge protection Load protection

Withdrawable surge arrester iQuick PRD Type 2 or Type 3 (cont.)

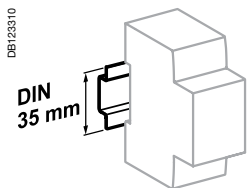

Clip on DIN rail 35 mm.

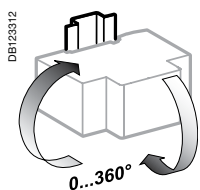

Indifferent position of installation.

4

Technical data

Main characteristics

Operating frequency	50/60 Hz		
Operating voltage (Ue)	230/400 V AC		
Disconnecter short-circuit withstand (Isc)	25 kA (50 Hz)		
Permanent operating current (Ic)	<1 mA		
Response time	<25 ns		
Status indication	By the cartridges	White	Operational
		Red	At end of life
	By white mechanical indicator/handle ON		Operational
	By red mechanical indicator/handle OFF		At end of life
Remote indication end of life	By the NO/NC remote indication contact 250 V AC / 2 A		

Additional characteristics

Degree of protection	Device only	IP20, IK05
	Device in modular enclosure	IP40
Operating temperature	-25°C to +70°C	
Storage temperature	-40°C to +80°C	
Certifications	NF, KEMA KEUR (iQuick PRD 8r, 20r)	

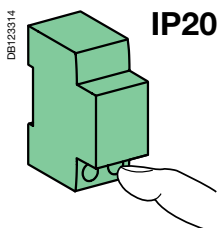

IP20

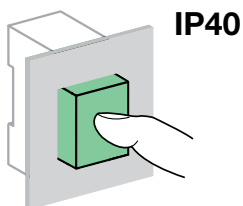

IP40

Weight (g)

Surge arresters

Type	iQuick PRD8r/20r	iQuick PRD40r
1P+N	435	445
3P+N	810	850

Dimensions (mm)

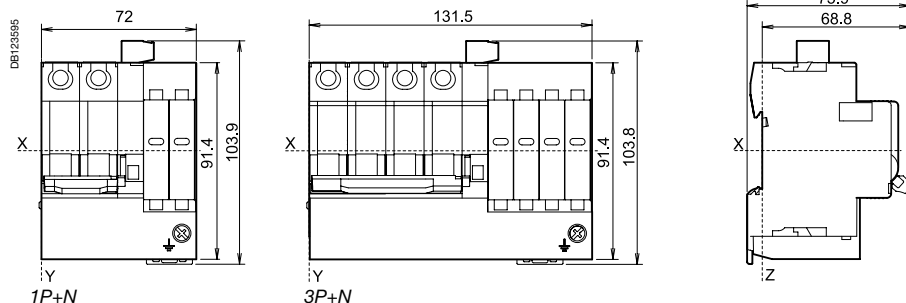



IEC 61643-1 T2
EN 61643-11 Type 2
UTE C 61740-51 T2
prEN 50539-11 T2



iPRD-DC40r 600PV

iPRD-DC direct current surge arresters are designed to protect against overvoltages due to a lightning strike: of the "DC" input to the inverter and of photovoltaic panels.

It should be installed in a switchboard inside the building. If the switchboard is located outside, it must be weatherproof.

Withdrawable iPRD-DC surge arresters allow damaged cartridges to be replaced quickly. They offer remote reporting of the "cartridge must be changed" message.



Catalogue numbers

Internal diagram	Imax (kA) Maximum discharge current	In (kA) Nominal discharge current	Up (kV) Protection level			U _{CPV} (V) ⁽¹⁾ Maximum steady state voltage			Width in module of 9 mm	Cat. no.
			L+/-	L-/-	L+/L-	L+/-	L-/-	L+/L-		
iPRD-DC40r 600PV										
	40	15	1.6	1.6	2.8	600	600	840	6	A9L16434
iPRD-DC40r 1000PV										
	40	15	3.9	3.9	3.9	1000	1000	1000	6	A9L16436

(1) U_{cpv} ≥ 1.2 x U_{oc stc} (U_{oc stc}: maximum no-load voltage of the photovoltaic generator "photovoltaic module manufacturer's data")



Replacement cartridges

Replacement cartridges		
Type	Replacement cartridges for	Cat. no.
C 40-600PV	iPRD-DC40r 600PV	A9L16683
C 40-1000PV	iPRD-DC40r 1000PV	A9L16692
C neutral PV	iPRD-DC40r 600PV	A9L16690

Connection

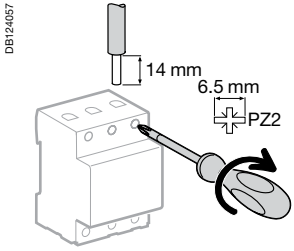

Type	Tightening torque	Copper cables	
		Rigid	Flexible or ferrule
iPRD-DC	2 N.m	2.5 to 25 mm ²	2.5 to 16 mm ²

4

Depending on the distance between the "generator" part and the "conversion" part, it may be necessary to install two surge arresters or more, to ensure protection of each of the two parts.

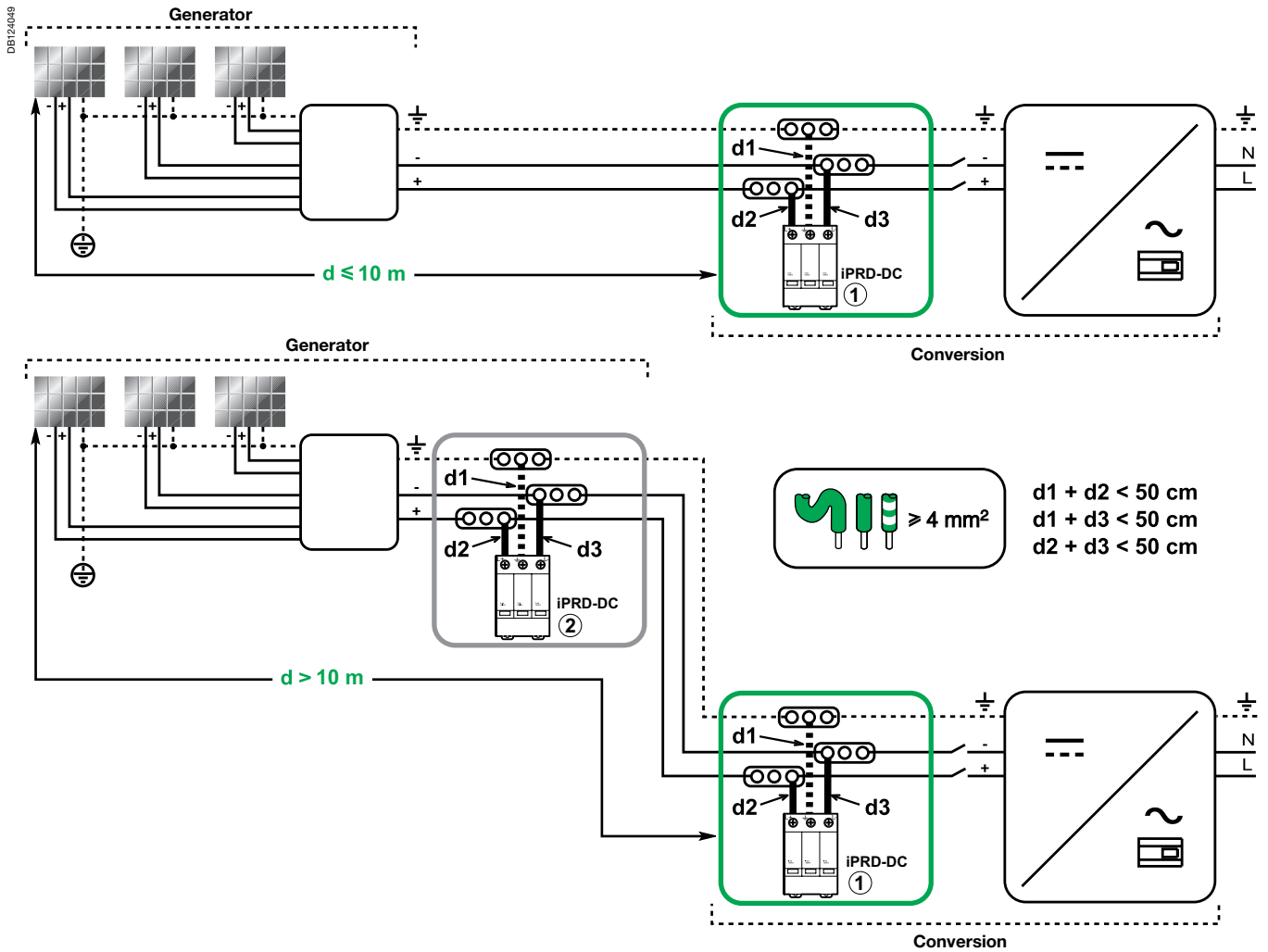

Protection

Load protection

iPRD-DC surge arresters

Withdrawable surge arresters type 2 for photovoltaic applications (cont.)

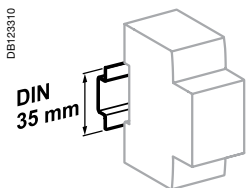

Clip on DIN rail 35 mm.

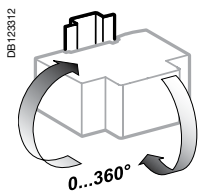

Indifferent position of installation.

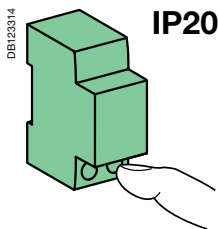

IP20

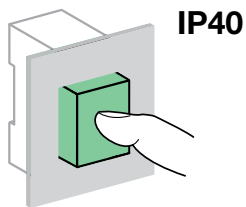

IP40

Technical data

Main characteristics

Type of network	Isolated direct current
Temps de réponse	< 25 ns
Short circuit current (I_{SCPV})	30 A
Type of surge arresters	Type 2
Type of self-protection	Circuit opened by integrated thermal disconnecter

Additional characteristics

Degree of protection (IEC 60529)	Device only	IP20	
	Device in modular enclosure	IP40	
	Chocs	IK03	
End-of-life indication	By the cartridges	White	Operational
		Red	At end of life
		By the NO/NC remote indication contact 250 V AC / 0.25 A	
Operating temperature	-25°C to +60°C		
Storage temperature	-40°C to +85°C		
Tropicalization (IEC 60068-1)	Treatment 2 (relative humidity of 95 % at 55°C)		

Weight (g)

Surge arresters

Type

iPRD-DC40r 600PV	400
iPRD-DC40r 1000PV	400

Dimensions (mm)

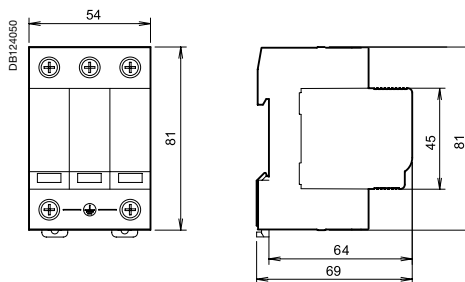

Each kit is supplied with:

- iPRD surge arrester
- Correctly rated 4 pole or 2 pole iC60H disconnection miniature circuit breaker
- Distributed neutral bar and SEA9NKIT connection
- Insulated high IP rated enclosure with transparent cover and lock
- L1, L2, L3, N, E connecting cables



Surge protection kits

Catalogue number	Type	Number of poles
PRD1PN20R	Type 2 Surge Arrester 20kA	1P+N
PRD1PN40	Type 2 Surge Arrester 40kA	1P+N
PRD1PN8	Type 2 Surge Arrester 8kA	1P+N
PRD3PN40	Type 2 Surge Arrester 40kA	3P+N
PRD3PN40R	Type 2 Surge Arrester 40kA	3P+N
PRD3PN65R	Type 2 Surge Arrester 65kA	3P+N
PRD3PN8	Type 2 Surge Arrester 8kA	3P+N

REDS, REDtest **pages 5/2 to 5/8**
Residual current circuit breakers page 5/2
Coordination table page 5/3
Operation pages 5/3 to 5/5
Wiring page 5/6
Technical pages 5/7 to 5/8

RED A type 30 mA **pages 5/9 to 5/13**
Residual current circuit breakers page 5/9
Coordination table page 5/9
Operation pages 5/10 to 5/11
Wiring page 5/12
Technical page 5/13

Protect Earth leakage protection Automatic recloser

REDs, REDtest



IMQ only for REDs,
cat. no. 18687 and 18689

IEC 61008, EN 61008

The REDs and the REDtest, **RE**sidual current **D**evice recloser, is made up of a residual current device and a recloser.

The **REDs** and **REDtest** **RE**sidual current **D**evice**s** offer the following functions:

- protection of people against direct and indirect contacts
- protection of installations against insulation faults
- disconnection of on-load electric circuits, already protected against overloads and short-circuits
- automatic restart after insulation monitoring of the downstream circuit.

REDtest provides the following additional functions:

- automatic and periodical test of the device, without breaking downstream circuit (REDtest).

Only used on TT and TN-S earthing grounding systems.



REDs 2P



REDs 4P



REDtest

Residual current circuit breakers	2P	4P
Making and breaking capacity, rated residual current ($\Delta I_m = I_m$)	630 A	630 A
Breaking capacity in association with protection device	6000 A (gL 63 A)	10,000 A (gL 80 A)

Catalogue numbers

REDs residual current circuit breakers REDs

A type				Width in mod. of 9 mm
2P	Sensitivity	30 mA	300 mA	
	Rating	25 A	18687	8
		40 A	18689	
		63 A	18691	
Voltage rating (Ue)		230 V		
Frequency rating		50Hz		
4P	Sensitivity	30 mA	300 mA	
	Rating	25 A	18264	14
		40 A	18266	
		63 A	18268	
Voltage rating (Ue)		400 V		
Frequency rating		50 Hz		

REDtest residual current circuit breakers

A Type			Width in mod. of 9 mm
2P	Sensitivity	30 mA	
	Rating	25 A	18280
		40 A	18281
Voltage rating (Ue)		230 V	
Frequency rating		50 Hz	

Protect Earth leakage protection Automatic recloser

REDs, REDtest (cont.)

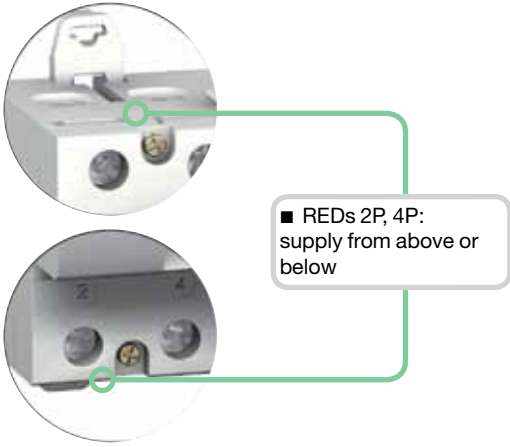

Coordination table, max short-circuit current (kA rms)

Circuit-breakers, fuse / A type REDs, REDtest coordination

		Circuit-breakers					Fuse	
		DPN	DPN N	iC60	C120	NG125	gL 63	gL 80
REDs A type 2P								
Network	25 A	6	6	10	10	10	6	-
230 V	40 A	6	6	10	10	10	6	-
L/N	63 A	-	-	10	10	10	6	-
REDs A type 4P								
Network	25 A	6	10	10	10	10	-	10
400 V	40 A	6	10	10	10	10	-	10
L/N	63 A	-	10	10	10	10	-	10
REDtest A type 2P								
Network	25 A	6	6	6	6	6	6	-
230 V	40 A	6	6	6	6	6	6	-
L/N								

DB 1223983

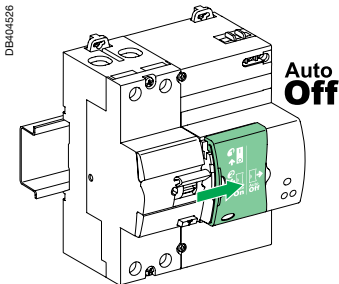
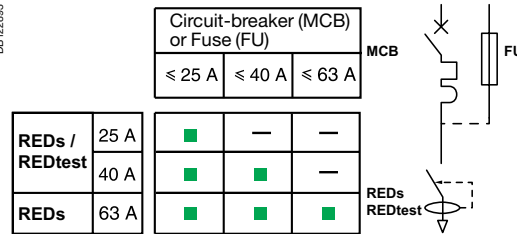

Fig. 1

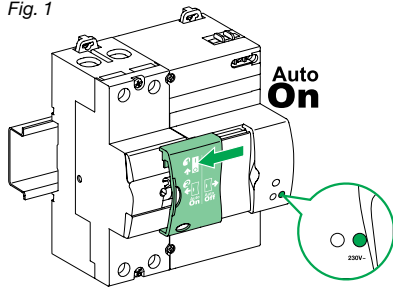
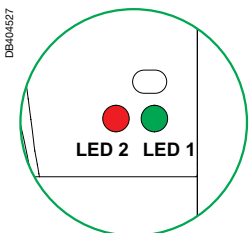

Fig. 2



	LED 1	LED 2
Test good	Green ON	OFF
Fault yellow ON	OFF	-

Operation

REDs

The REDs operates in the residual current device mode, without automatic restart, when the sliding cover is open, i.e. to the right in the Auto Off position (Fig. 1).

The automatic restart mode and the Autotest are activated, when the sliding cover is closed, i.e. to the left in the Auto On position (Fig. 2).

Test

⚠ This is only possible in manual mode, i.e. sliding cover open in the Auto Off position. You can then manually test the device by pressing the Test key. The downstream installation is then temporarily broken. You must then manually reclose the RED by activating the O-I lever to power supply the downstream circuit.

REDtest

■ The REDtest carries out automatic testing of earth leakage protection every months.

The test consists in opening and reclosing the REDtest, during which time continuity of supply of the downstream installation is guaranteed.

Autotest: after checking installation insulation, the REDtest monitors its residual current device, without breaking the downstream power supply (bypass by bypass contact).

Operation ON mode: temporary network fault
REDs, REDtest

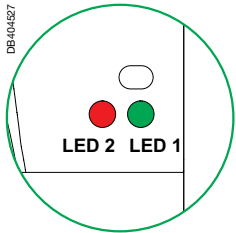

(*) Reclosing time.

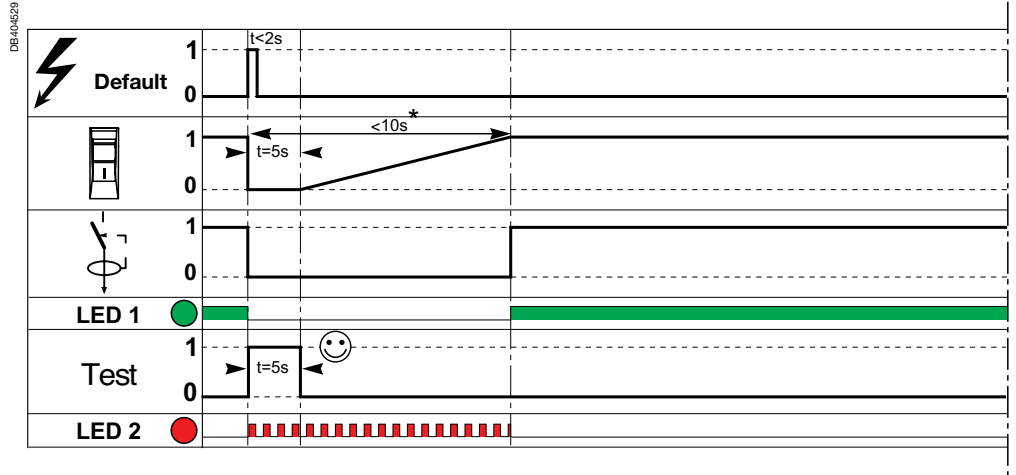

The built-in automatic recloser automatically recloses the residual current device after checking insulation of the downstream circuit.
Rd: lower level of insulation resistance, if $R < R_d$ = no reclose
Rdo: higher level of insulation resistance, if $R > R_{do}$ = reclose

5

$I_{\Delta n}$	30 mA	300 mA
Rd	8 k Ω	2.5 k Ω
Rdo	16 k Ω	5 k Ω

Operation ON mode: long network fault

REDs

If the circuit is faulty, the switch is prohibited from reclosing. After a time delay of 15 minutes, the downstream circuit insulation is rechecked.

There are then two possibilities:

- the installation is still faulty (the resistance to earth is lower than Rd): in this case a new check will be carried out in 15 minutes.
- the fault was temporary and has disappeared (the resistance to earth is higher than Rdo): the recloser automatically recloses the REDs.

DB404530

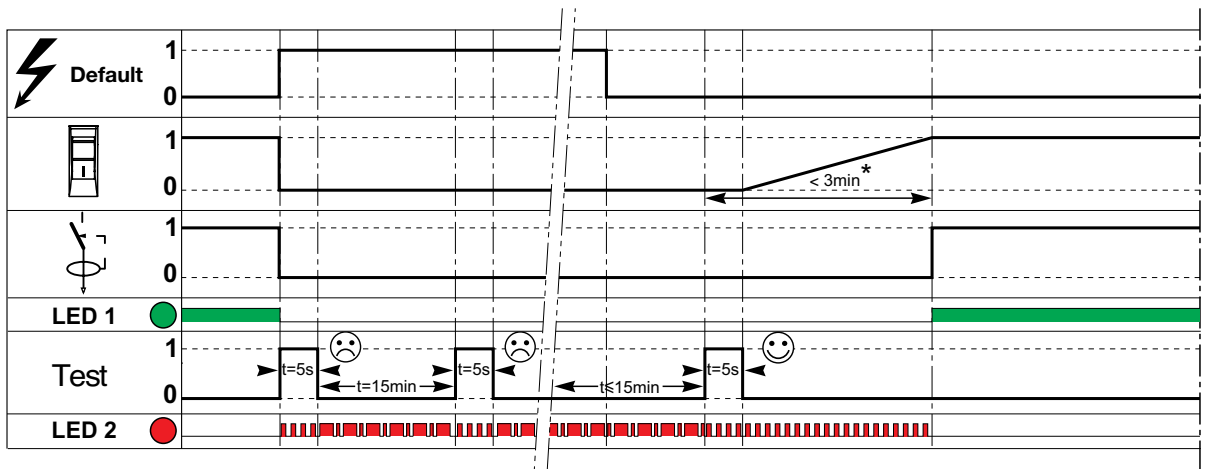

(*) Reclosing time.

Protect Earth leakage protection Automatic recloser

REDs, REDtest (cont.)

$I\Delta n$	30 mA
Rd	30 k Ω
Rdo	70 k Ω

Operation ON mode: long network fault (cont.)

REDtest

If the circuit is faulty for a length of time "greater than 5 seconds", the switch is prohibited from reclosing.

- The installation is faulty: the earth resistance is lower than Rd.

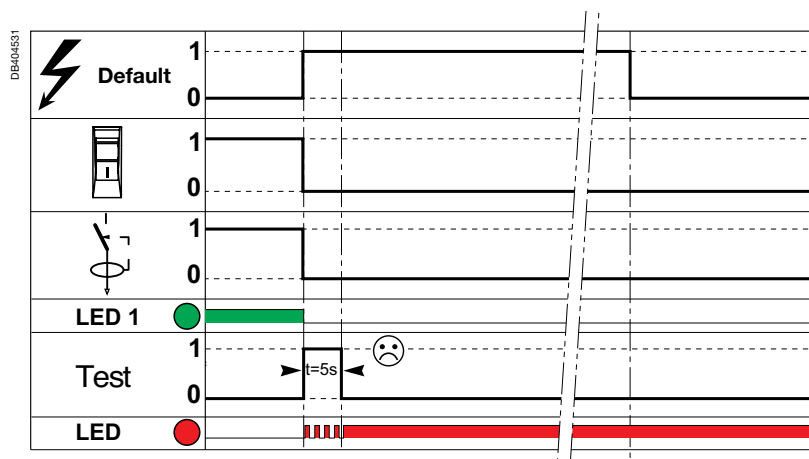

5

Connection

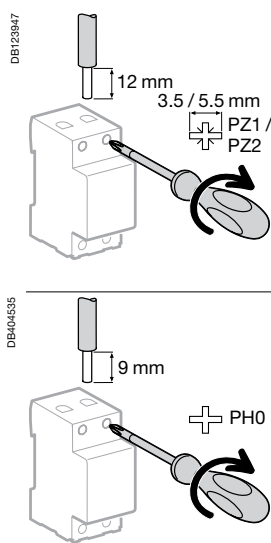

Type	Tightening torque	Copper cables	
		Rigid	Flexible or ferrule
N, L	2 N.m	35 mm ²	35 mm ²
AUX	0.4 N.m	2.5 mm ²	2.5 mm ²

Connection by tunnel terminal with guard

Protect Earth leakage protection Automatic recloser

REDs, REDtest (cont.)

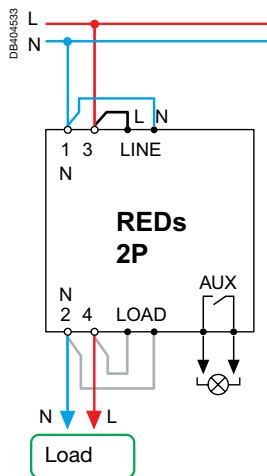

Wiring of non-polarized white wires

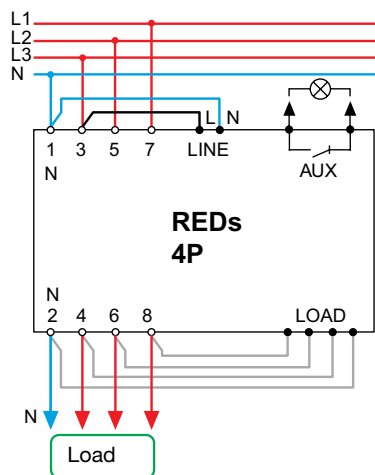

Wiring of non-polarized white wires

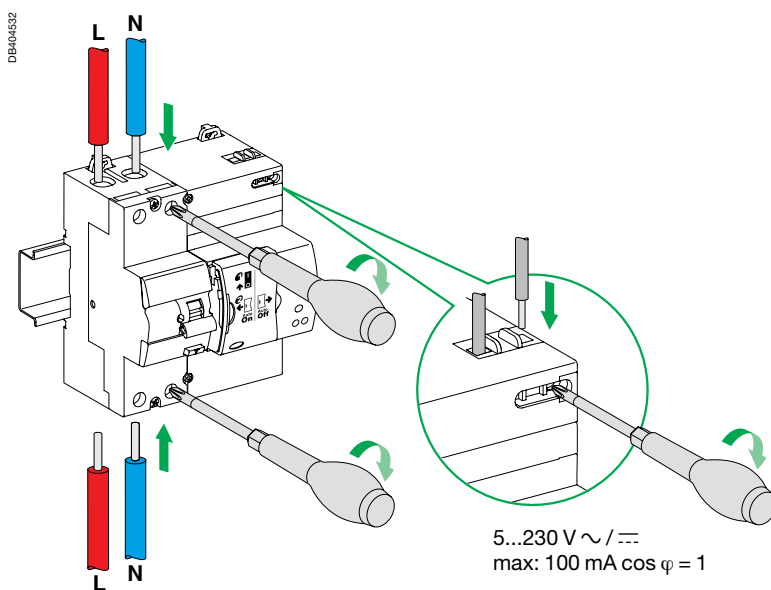
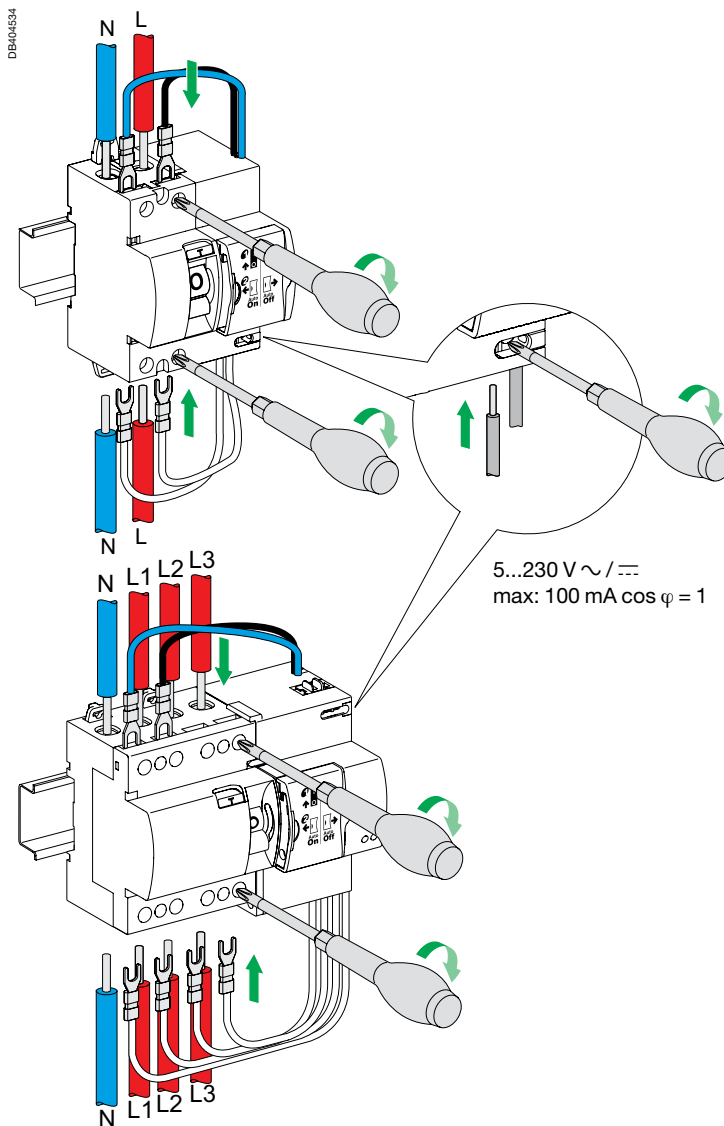
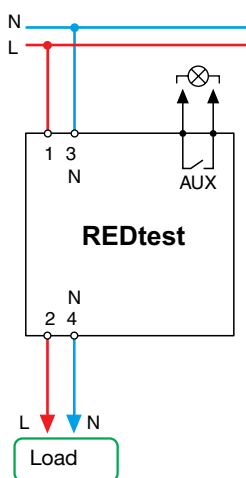

Protect Earth leakage protection Automatic recloser

REDs, REDtest (cont.)

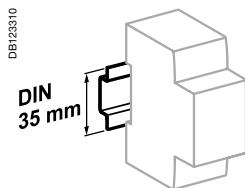

Clip on DIN rail 35 mm.

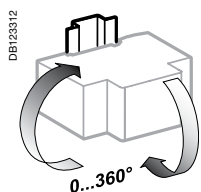

Indifferent position of installation.

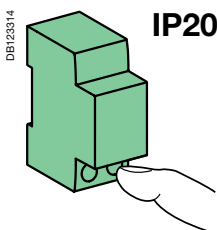

IP20

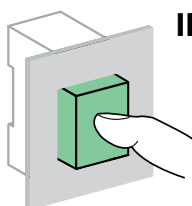

IP40

Technical data

Main characteristics	2P	4P
Common technical data	REDs, REDtest	REDs
Earthing grounding systems	TT and TN-S only	
Impulse withstand voltage (Uimp)	4 kV	
Insulation voltage (Ui)	500 V	
8/20 µs wave immunity level	250 Å	
Tropicalisation	Treatment 2 (relative humidity: 95 % at 55°C)	
Operating temperature	-5°C to +40°C	
Storage temperature	-20°C to +60°C	
Protection class	IP20 at terminals	
Additional characteristics		
Residual current device		
Tripping time	IΔn: ≤ 300 ms	
	5 IΔn: ≤ 40 ms	
Number of cycles (O-C)	1 000	4 000
Fixed sensitivity releases for all ratings	Instantaneous release	
Test button min operating voltage	■ 100 V	170 V
	■ 195 V (REDtest)	
Recloser		
Max duration of a restart cycle	90 s	< 10 s
Maximum number of consecutive restart attempts (if no earth fault)	3	
Min interval between 2 closings	180 s	30 s
Insulation fault presence monitoring	Yes	
Restart in event of transient insulation fault	Yes	
Stopping restart cycle if insulation fault present	■ Yes, during 15 minutes	
	■ Yes (REDtest)	
Not operating resistance to earth (Rd)	8 kΩ (30 mA), 2.5 kΩ (300 mA)	
Operating resistance to earth (Rdo)	16 kΩ (30 mA), 5 kΩ (300 mA)	
Power consumed by the electronics	■ REDs: 0 VA	
	■ REDtest: 8 VA	
Indication		
REDs status indication	Mechanical: by O-I (open-closed) 2-position lever	
	■ Electrical: by 2 indicator lights on the front panel:	
	□ left: red/yellow LED	
	□ right: green LED	
	Remote: by 1 built-in auxiliary contact	
Auxiliary contact		
Voltage rating (Ue)	5...230 V AC/DC	
Insulation voltage (Ui)	350 V	
Current rating (In)	Min: 0.6 mA	
	Max: 100 mA, power factor = 1	
Type	Configurable: intermittent 1 Hz or NO	
Connection by tunnel terminal	Flexible or rigid cable: max 2.5 mm ²	

5

Weight (g)

Reclosers	2P	4P
REDs	360	<ul style="list-style-type: none"> ■ 25/40 A: 670 ■ 63 A: □ 30 mA: 720 □ 300 mA: 680
REDtest	370	-

Dimensions (mm)

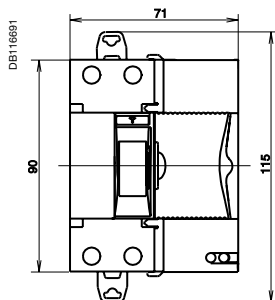

REDs 2P

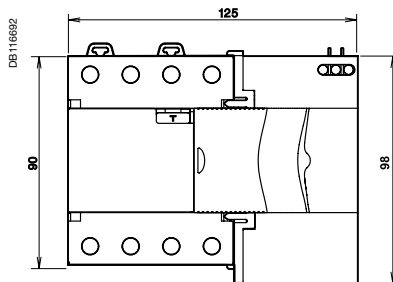
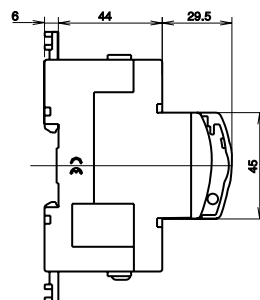

REDs 4P

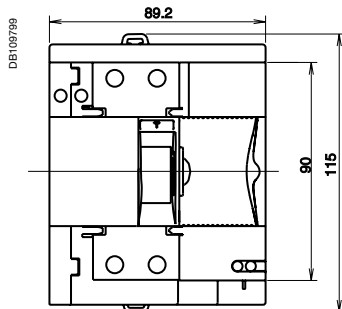
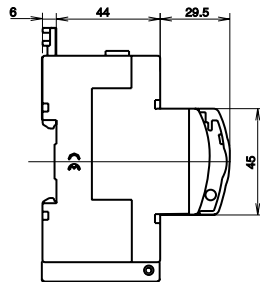

REDtest

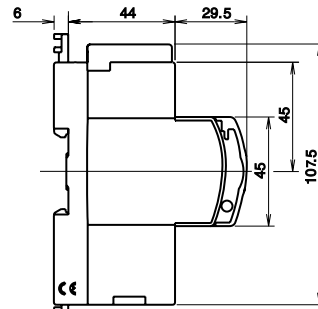

Protect Earth leakage protection Automatic recloser

RED
A type
30 mA



IEC 61008, EN 61008

The RED **RE**sidual current **D**evice **rec**loser, is made up of a residual current device and a recloser.

- protection of people against direct and indirect contacts
- protection of installations against insulation faults
- disconnection of on-load electric circuits, already protected against overloads and short-circuits
- automatic restart after insulation monitoring of the downstream circuit.

Catalogue numbers

Residual current circuit breaker RED			
Type			Width in mod. of 9 mm
2P	Sensitivity	30 mA	8
	Rating	25 A	
		40 A	18695
Voltage rating (Ue)		230 V	
Frequency rating		50 Hz	

DBI122882

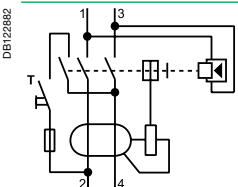

FB101779_SE-50



18681

DBI404503

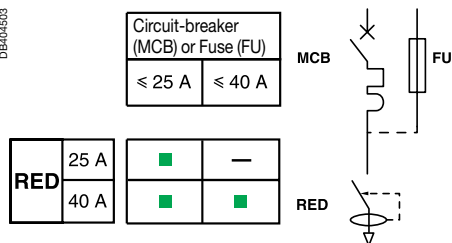

Coordination table, max short-circuit current (kA rms)

Circuit-breakers, fuse / RED type A

	Circuit-breakers	Circuit-breakers						Fuse gL 63
		C32	K60	DT40	DT40N	C60	C120	
RED A Type								
Network 230 V	25 A	4.5	6	6	6	6	6	6
L/N	40 A	4.5	6	6	6	6	6	6

5

Protect Earth leakage protection Automatic recloser

RED
A type
30 mA (cont.)

PE101779_SE-50



5

DE40-504

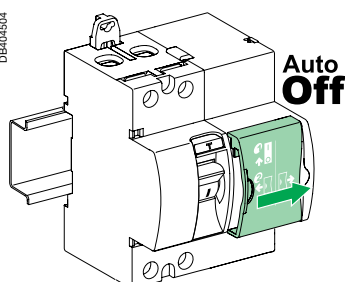

Fig. 1

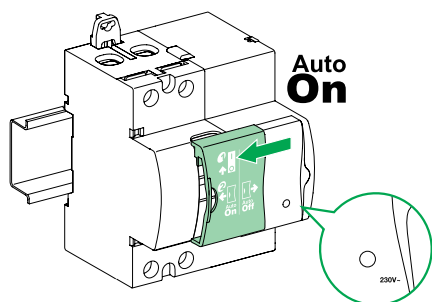

Fig. 2

Operation

Recloser

The built-in automatic recloser automatically recloses the residual current device after checking insulation of the downstream circuit.

If the resistance to earth is lower than R_d , then RED reclosing is prohibited. If the resistance to earth is higher than R_{do} , then RED reclosing is allowed.

Residual current device

The RED operate in the residual current device mode, without automatic restart, when the sliding cover is open, i.e. to the right in the Auto Off position (Fig. 1).

The automatic restart mode and the Autotest are activated, when the sliding cover is closed, i.e. to the left in the Auto On position (Fig. 2).

Test

⚠ This is only possible in manual mode, i.e. sliding cover open in the Auto Off position. You can then manually test the device by pressing the Test key. The downstream installation is then temporarily broken. You must then manually reclose the RED by activating the O-I lever to power supply the downstream circuit.

Protect Earth leakage protection Automatic recloser

RED
A type
30 mA (cont.)

Operation ON mode

Temporary network fault

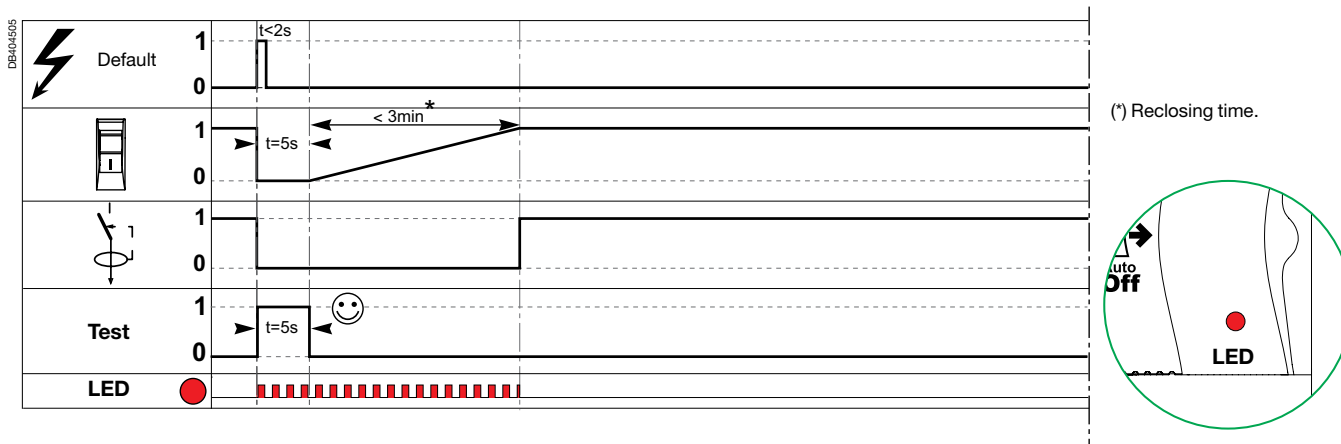

Long network fault

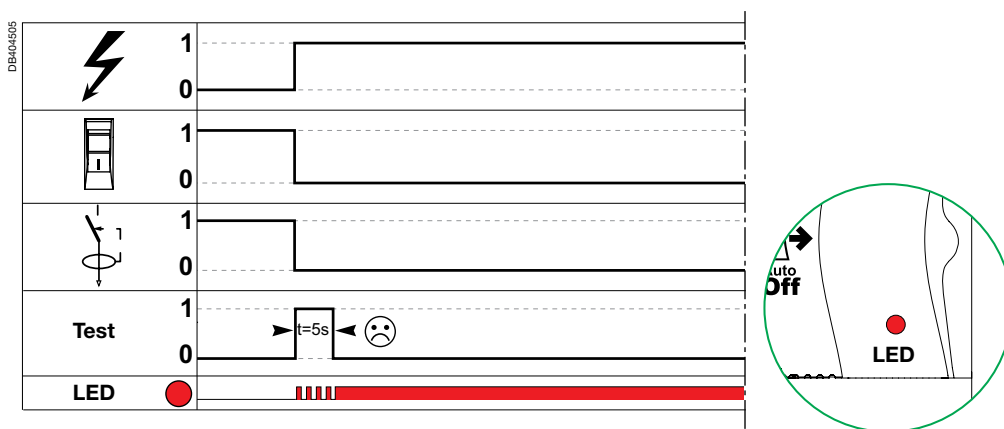

5

$I\Delta n$	30 mA	300 mA
Rd	8 k Ω	2.5 k Ω
Rdo	16 k Ω	5 k Ω

Rd: lower level of insulation resistance, if $R < R_d$ = no reclose
Rdo: higher level of insulation resistance, if $R > R_{do}$ = reclose

Protect Earth leakage protection Automatic recloser

RED
A type
30 mA (cont.)

Connection

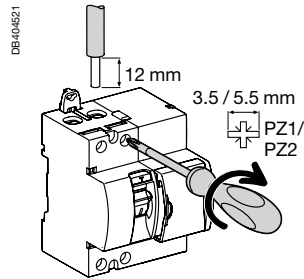

Calibre	Tightening torque	Copper cables	
		Rigid	Flexible or ferrule
25 to 40 A	2 N.m	35 mm ²	25 mm ²

Connection by tunnel terminal with guard

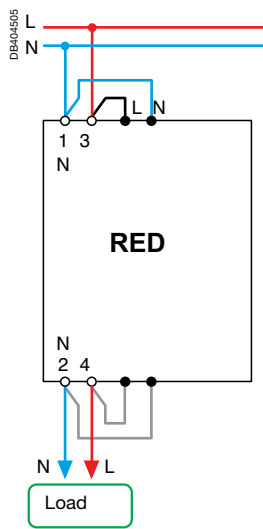

Wiring of non-polarized white wires

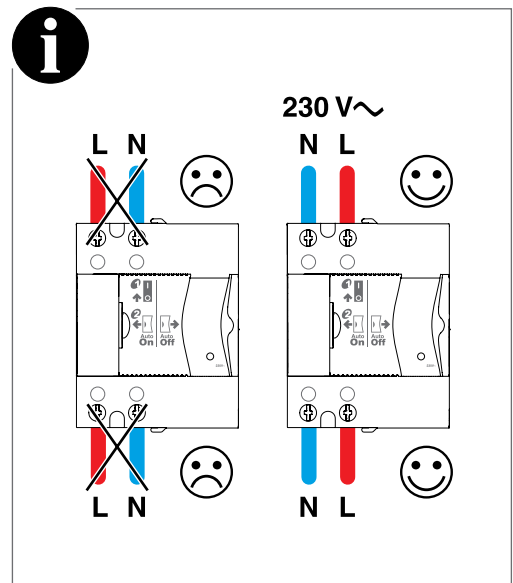
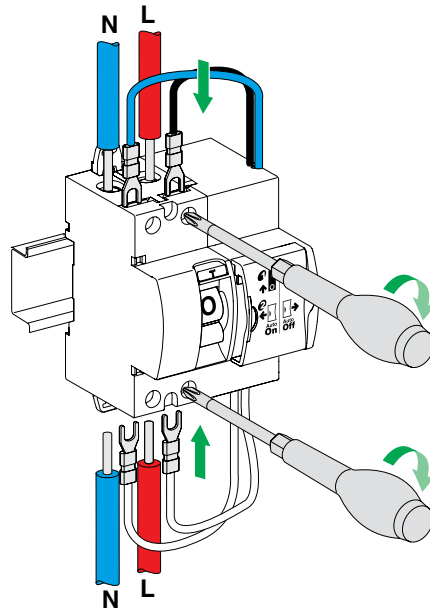

5

Protect Earth leakage protection Automatic recloser

RED A type 30 mA (cont.)

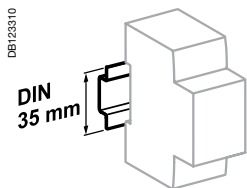

Clip on DIN rail 35 mm.

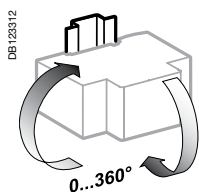

Indifferent position of installation.

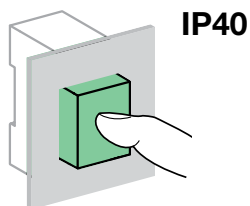
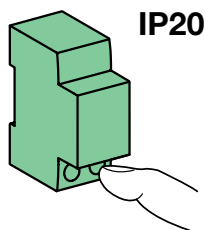

Technical data

Main characteristics

RED 25...63 A A type

Earthing grounding systems	TT and TN-S only
Impulse withstand voltage (Uimp)	4 kV
Insulation voltage (Ui)	500 V
8/20 µs wave immunity level	250 A
Tropicalisation	Treatment 2 (relative humidity: 95 % at 55°C)
Operating temperature	-5°C to +40°C
Storage temperature	-20°C to +60°C
Protection class	IP20 at terminals

Additional characteristics

Residual current device

Making and breaking capacity, rated residual current ($I_{\Delta m} = I_m$)	630 A
Breaking capacity in association with protection device	6000 A (gL 63 A)
Tripping time	$I_{\Delta n}: \leq 300$ ms $5 I_{\Delta n}: \leq 40$ ms
Number of cycles (O-C)	Mechanical: 1 000
Fixed sensitivity releases for all ratings	Instantaneous release
Test button min operating voltage	100 V

Recloser

Max duration of a restart cycle	90 s
Number of restart operations	15/hour
Maximum number of consecutive restart attempts (if no earth fault)	3
Min interval between 2 closings	180 s
Insulation fault presence monitoring	Yes
Restart in event of transient insulation fault	Yes
Stopping restart cycle if insulation fault present	Yes
Not operating resistance to earth (Rd)	20 kΩ
Operating resistance to earth (Rdo)	70 kΩ
Power consumed by the electronics	S = 0 VA

Indication

RED status indication	Mechanical: by O-I (open-closed) 2-position lever Electrical: by 1 red indicator light on the front panel
-----------------------	--

Weight (g)

Recloser

RED	350
-----	-----

Dimensions (mm)

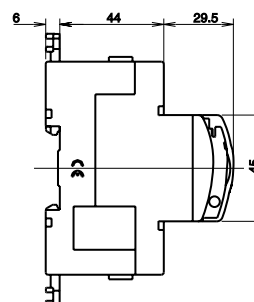
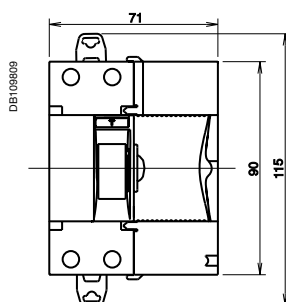

Reflex iC60H **pages 6/2 to 6/6**
Miniature circuit breakers page 6/2
Features..... page 6/3
Operating modes..... page 6/4
Power and control connection page 6/5
Technical data..... page 6/6

ARA automatic reclosures..... **pages 6/7 to 6/11**
ARA automatic reclosures..... page 6/7
Operating principle page 6/8
Permanent fault diagrams page 6/9
Features..... page 6/10
Connection and technical data page 6/11

RCA remote controls..... **pages 6/12 to 6/15**
RCA remote controls..... page 6/12
Modes page 6/13
Features..... page 6/14
Connection and technical data page 6/15

Acti 9 smartlink..... **pages 6/16 to 6/22**
Functions and installation page 6/16
Accessories and connectable devices page 6/17
Example of an installation page 6/18
Ethernet and Modbus Slave page 6/19
Technical characteristics..... pages 6/20 to 6/21
Connection page 6/22

Control, remote control Integrated control circuit breakers

Reflex iC60H (curves B, C, D)

PB106239-40



ComReady

PB106238-40



IEC/EN 60947-2

The Reflex iC60 devices are integrated control circuit breakers which combine the following main functions in a single device:

- Remote control by latched and/or impulse-type order according to the 3 operating modes to be chosen by the user.
- Circuit breaker, to provide:
 - circuit protection against short-circuit currents,
 - circuit protection against overload currents,
 - disconnection in the industrial sector.

Resetting after a fault is performed manually, by the resetting handle.

The version with Ti24 allows direct interfacing of the Reflex iC60 with a PLC, to:

- Execute remote control (Y3).
- Indicate the state of the control circuit (O/C) and circuit-breaker state information (auto/OFF).

The Ti24 interface also allows fast, reliable connection of the Reflex iC60 to the Acti 9 Smartlink thanks to the prefabricated cables.

The IMDU auxiliary allows the Reflex iC60 to be controlled in 24/48 V AC/DC.

Alternating current (AC) 50 Hz				
Ultimate breaking capacity (Icu) as per IEC/EN 60947-2				Service breaking capacity (Ics)
Ph/Ph (2P, 3P, 4P)	Voltage (Ue)		380 to 415 V	
	220 to 240 V			
Reflex iC60H				
Rating (In)	10 to 40 A	30 kA	15 kA	50 % of Icu

6

Catalogue numbers

Reflex iC60 circuit breaker									
Type	2P			3P			4P		
Rating (In)	Curve			Curve			Curve		
	B	C	D	B	C	D	B	C	D
Reflex iC60H									
With Ti24 interface									
10 A	A9C64210	A9C65210	A9C66210	A9C64310	A9C65310	A9C66310	A9C64410	A9C65410	A9C66410
16 A	A9C64216	A9C65216	A9C66216	A9C64316	A9C65316	A9C66316	A9C64416	A9C65416	A9C66416
25 A	A9C64225	A9C65225	A9C66225	A9C64325	A9C65325	A9C66325	A9C64425	A9C65425	A9C66425
40 A	A9C64240	A9C65240	-	A9C64340	A9C65340	-	A9C64440	A9C65440	-
Width in 9 mm modules	9			11			13		

Control, remote control Integrated control circuit breakers

Reflex iC60H (curves B, C, D) (cont.)

ComReady

- Tripping and disconnection device capable of:
 - disconnecting and padlocking (Ø 3 to 6 mm not supplied) in "open" position
 - neutralizing remote control
- Ti24 interface for direct link to PLC and Acti 9 Smartlink
- IP20 insulated terminals
- Bistable operation: does not change state in the event of electrical power outage
- Operating state indicator lamp
- Resetting handle
- Pushbutton:
 - manual control: opening/closing
 - choice of operating "modes"
- VisiSafe**
 - Positive contact indication
 - Uimp: 6 kV
 - Ui: 500 V
 - Degree of pollution: level 3

- Longer product service life thanks to:
 - good overvoltage withstand capacity: products designed to provide a high industrial performance level (degree of pollution, rated impulse withstand voltage and insulation voltage),
 - high limitation performances,
 - fast closure independent of the speed of resetting of the operating handle.

Legend

Ti24 interface

+24VDC	V DC power supply
Y3	Remote control by latched order
auto/OFF	Circuit-breaker state information
O/C	Control circuit state information (open/closed)
0 V	V DC power supply

DB123765



DB123516



Y1	Latched order control
Y2	Control by impulse-type
N	230 V AC power supply
P	
O/C	Control circuit state indication contact
auto/OFF	Circuit-breaker tripping indication contact

Control, remote control Integrated control circuit breakers

Reflex iC60H (curves B, C, D) (cont.)

DB123517



■ Operating state indicator lamp

■ Pushbutton for:
□ "mode" selection
□ opening/closing manual control

Remote control is possible by 3 operating modes to be set using the pushbutton on the front panel.

Three types of control: Y1, Y2, Y3

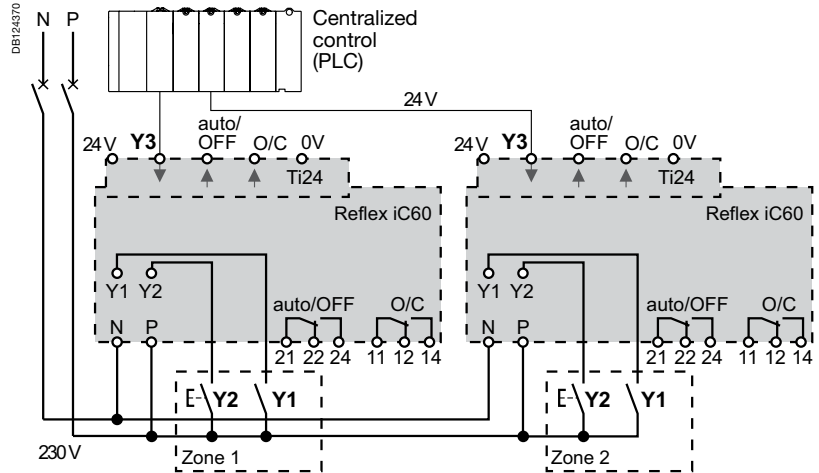

Operating modes

Mode 1: Reflex iC60 opening/closing, locally or centrally controlled

- The opening/closing orders come from various control points, and they are taken into account in their order of arrival
- Y1: latched order local control
- Y2: impulse-type local control
- Y3: latched order centralized control

Mode 2: Reflex iC60 opening/closing, possible inhibition of local impulse-type control

- Y1 is used to inhibit Y2
- Y1: local opening/Y2 inhibition latched order control
- Y2: impulse-type local opening/closing control
- Y3: latched order centralized opening/closing control

Mode 3: Reflex iC60 opening/closing, possible inhibition of centralised latched order control

- Y1 is used to inhibit Y3
- Y3 inhibition local latched order control
- Y2: impulse-type local opening/closing control
- Y3: latched order centralized opening/closing control

Reflex iC60 with Ti24 interface

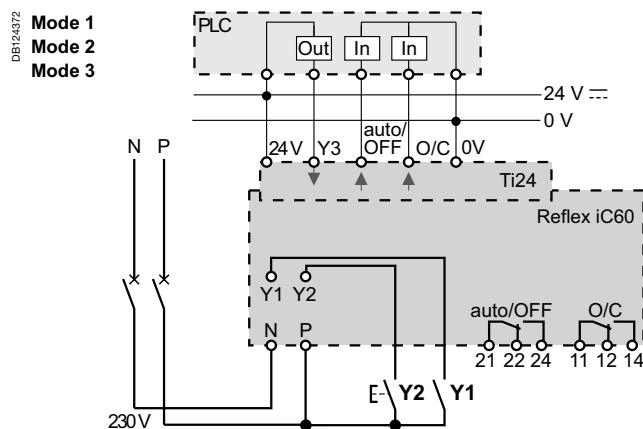

Table of modes

	Mode 1	Mode 2	Mode 3
Reflex iC60 with interface Ti24	■ Possible mode	■ Possible mode	■ Default mode

Control, remote control Integrated control circuit breakers

Reflex iC60H (curves B, C, D) (cont.)

Power connection

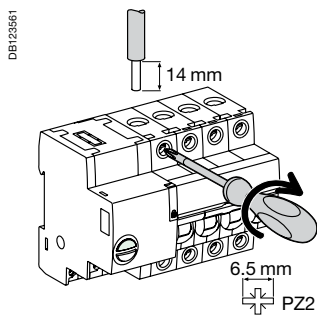

Terminal	Rating	Tightening torque	Without accessories		With accessories			
			Copper cables		Al terminal 50 mm ²	Screw-on connection for ring terminal	Multi-cable terminal	
			Rigid	Flexible or with ferrule			Rigid cables	Flexible cables
Power	10 to 25 A	2 N.m	1 to 25 mm ²	1 to 16 mm ²	-	Ø 5 mm	-	-
	40 to 63 A	3.5 N.m	1 to 35 mm ²	1 to 25 mm ²	50 mm ²		-	3 x 16 mm ²

Control connection

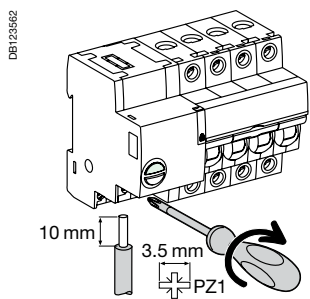

Terminal	Tightening torque	Without accessories		
		Copper cables		
		Rigid	Flexible	Flexible with ferrule
Power supply (N/P) Inputs (Y1/Y2)	1 N.m	1 to 10 mm ²	1 to 6 mm ²	1 to 4 mm ²
Outputs (O/C, auto/OFF)	0.7 N.m	1 to 2.5 mm ²	1 to 2.5 mm ²	1 to 1.5 mm ²
Ti24 interface	Spring-loaded terminals	0.5 to 1.5 mm ²	0.5 to 1.5 mm ²	0.5 to 1.5 mm ²

Control, remote control Integrated control circuit breakers

Reflex iC60H (curves B, C, D) (cont.)

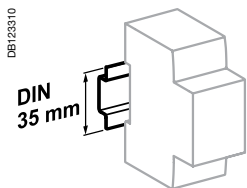

Clip on DIN rail 35 mm.

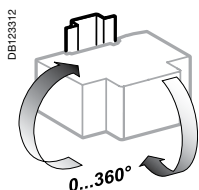

Indifferent position of installation.

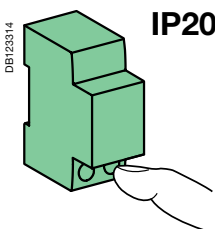

IP20

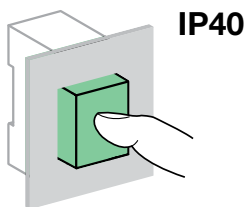

IP40

Technical data

Control circuit

Supply voltage (Ue) (N/P)		230 V AC - 50 Hz
Control voltage (Uc)	Inputs (Y1/Y2)	230 V AC - 5 mA (24...48 V AC/DC, with iMDU auxiliary)
	Input (Y3)	24 V DC - 5.5 mA
Min. duration of control impulse (Y2)		≥ 250 ms
Response time (Y2)		≤ 200 ms
Consumption		≤ 1 W
Inrush consumption		< 1000 VA
Length of control wires	Inputs (Y1/Y2)	Cable: 100 m Wires in a sheath: 500 m
	Input (Y3)	500 m
Inrush current at 230 V - 50 Hz	2P	4.2 Å
	3P	8.2 Å
	4P	16.2 Å

Power circuit

Max. working voltage (Ue)		400 V AC
Insulation voltage (Ui)		500 V
Rated impulse withstand voltage (Uimp)	Set to Disconnected	6 kV
	Set to Ready	4 kV
Thermal tripping	Reference temperature	50°C
Magnetic tripping	Curve B	4 I _n ± 20 %
	Curve C	8 I _n ± 20 %
	Curve D	12 I _n ± 20 %
Overvoltage category (IEC 60364)		IV
Temperature derating		See module CA908007

Indication / Remote control

Potential-free changeover contact outputs (O/C, auto/OFF)	Min.	24 V DC - 100 mA
	Max	230 V AC - 1 A

Ti24 interface (as per IEC 61131)

Outputs (O/C, auto/OFF)	Ti24 interface	24 V DC - 100 mA max
-------------------------	----------------	----------------------

Endurance (O-C)

Electrical	AC1 - AC7a	Up to 50,000 cycles ⁽¹⁾
	AC5a - AC5b	Up to 15,000 cycles ⁽¹⁾
	AC7c	Up to 20,000 cycles ⁽¹⁾
Mechanical		50,000 cycles

Additional characteristics

Degree of protection (IEC 60529)	Device only	IP20
	Device in a modular enclosure	IP40 Insulation class II
Degree of pollution		3
Operating temperature		-25°C to +60°C
Storage temperature		-40°C to +85°C
Tropicalization		Treatment 2 (relative humidity of 93 % at 40°C)
Immunity to voltage dips		IEC 61000-4-11 class III
Immunity to power supply frequency variations		IEC 61000-4-28 and IACS E10
Immunity to harmonics		IEC 61000-4-13 class 2
Immunity to electrostatic discharges	Air	8 kV, IEC 61 000-4-2
	Contacts	4 kV, IEC 61 000-4-2
Immunity to stray magnetic fields		10 V/m up to 3 GHz, IEC 61000-4-3
Immunity to fast transients		4 kV from 5 to 100 kHz, IEC 61000-4-4
Immunity to shock waves		IEC 61000-4-5
Immunity to power frequency magnetic fields		10 V from 150 kHz to 80 MHz, IEC 61000-4-6
Immunity to grid frequency magnetic fields		Level 4 30 A/m to IEC 61000-4-8 and IEC 61000-4-9
Conducted emissions		CISPR 11/22
Radiated emissions		CISPR 11/22

(1) See the derating table according to the load types and ratings



ARA iC60



ARA iID

The ARA reclosing auxiliary can:

- Perform automatic reclosing of the associated protection device, after tripping.
- Increase the availability of installations without supervision, isolated, hard of access and demanding very great availability (mobile telephony systems, motorways, pumping stations, airports, railways, meteorological stations, service stations, automatic teller machines, public lighting, tunnels, etc.), by restoring them to operation without intervention by personnel in the event of a transient fault (atmospheric disturbances, industrial overvoltages, etc.).
- For the ARA iC60, the operator can choose predefined reclosing program which allows the safety and availability of facilities to be reconciled taking into account the facility's environment.
- The circuit is placed in safety configuration by the padlocking device.

Catalogue numbers

ARA iC60				
For circuit breaker				Width in 9 mm modules
1P, 1P+N, 2P	Number of programs	Voltage		
	4	230 V AC, 50/60 Hz	A9C70132	7
3P, 4P				
	4	230 V AC, 50/60 Hz	A9C70134	7
ARA iID				
For residual current circuit breaker				Width in 9 mm modules
2P	Number of programs	Voltage		
	1	230 V AC, 50/60 Hz	A9C70342	7
4P				
	1	230 V AC, 50/60 Hz	A9C70344	7
Auxiliaries		See module CA907000 and CA907002		

Diagram

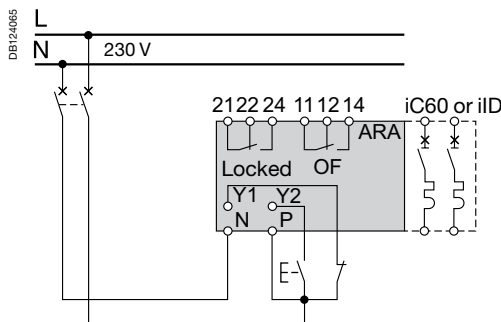

Legend		
Type	Application	
1 2 4 3	Choice of program (ARA iC60)	
Y1	"Remote" inhibition of automatic reclosing	
Y2	Remote control of final reclosing	
N	230 V power supply	
P		
Locked 21 22 24	Automatic recloser inhibition indication contact	
OF 11 12 14	Indicates the state of the circuit breaker or residual current circuit breaker (opened or closed)	
Indicator lamp	Flashing green ▲▲▲▲	ARA automatic recloser operational
	Flashing red ▲▲▲▲	Reclosing cycle in progress
	Fixed red ■	ARA automatic recloser locked at end of reclosing cycle: circuit breaker or residual current circuit breaker tripped (open)
	Flashing orange ▲▲▲▲	ARA automatic recloser not operational

ARA automatic reclosers (cont.)

For iC60 circuit breakers
and iID residual current circuit breakers





Operating principle

The ARA automatic recloser makes a number of attempts at reclosing depending on the program chosen by the user.

The program includes the following settings:

- A time delay before reclosing (TA).
- A reinitialization time delay (TB).
- A maximum number of reclosing attempts.

If, following these attempts, the fault is still present, the device places itself in waiting for manual reclosing, or final remote reclosing (Y2).

ARA iC60		Number of reclosing attempts	Delay before reclosing	Check time	Final reclosing Y2
			TA	TB	
Program					
DB124061  DB124062  DB124063  DB124064 	1 2 4 3	1	60 s	6 min.	Once after inhibition
	1 2 4 3	3	60 s 3 min. 3 min.	2 min. 6 min. 6 min.	
	1 2 4 3	5	60 s 3 min. 3 min. 3 min. 3 min.	2 min. 6 min. 6 min. 6 min. 6 min.	
	1 2 4 3	5	60 s 3 min. 4 min. 5 min. 6 min.	2 min. 6 min. 8 min. 10 min. 12 min.	

ARA iID		Number of reclosing attempts	Delay before reclosing	Check time	Final reclosing Y2
			TA	TB	
Only 1 program available		15	20 s 40 s 3 min. 3 min. ...	30 min. 30 min. ...	Once per cycle

ARA iC60 operating diagram

DB404539

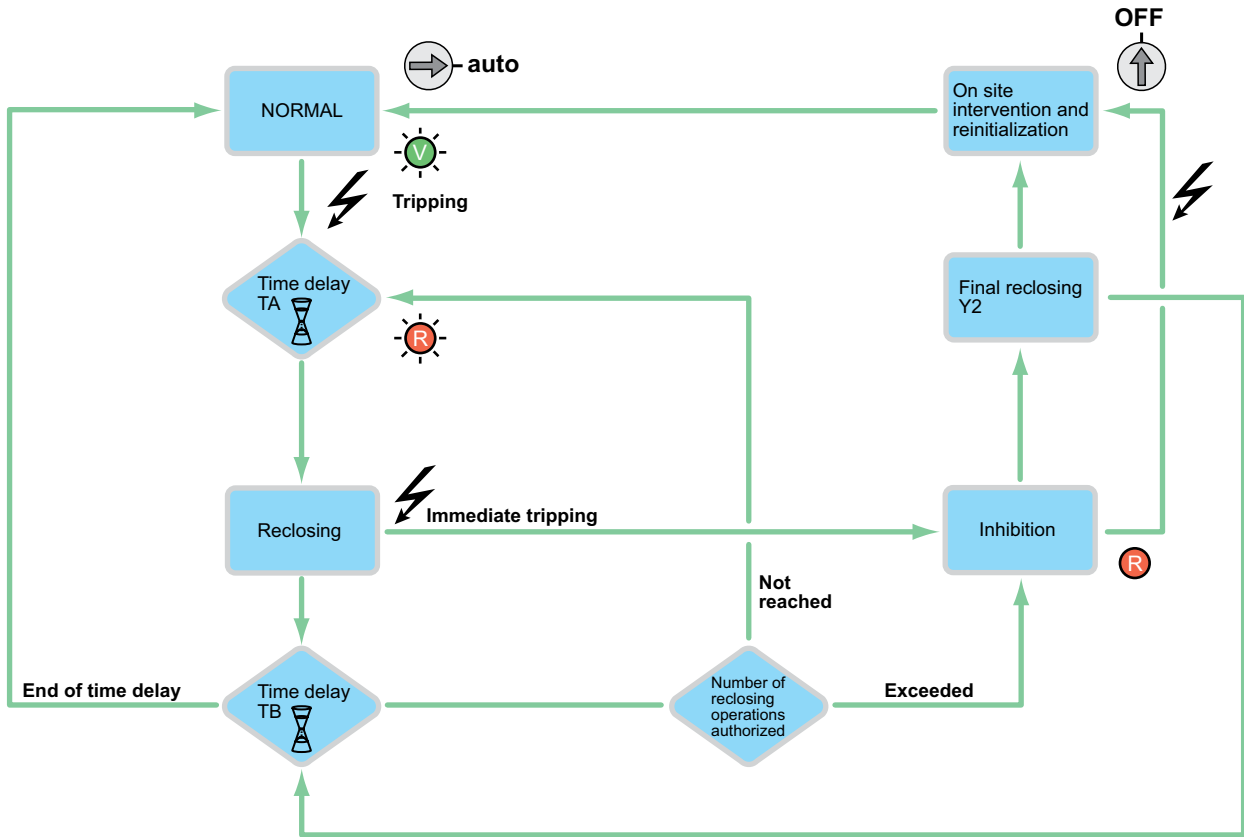

ARA iID operating diagram

DB404538

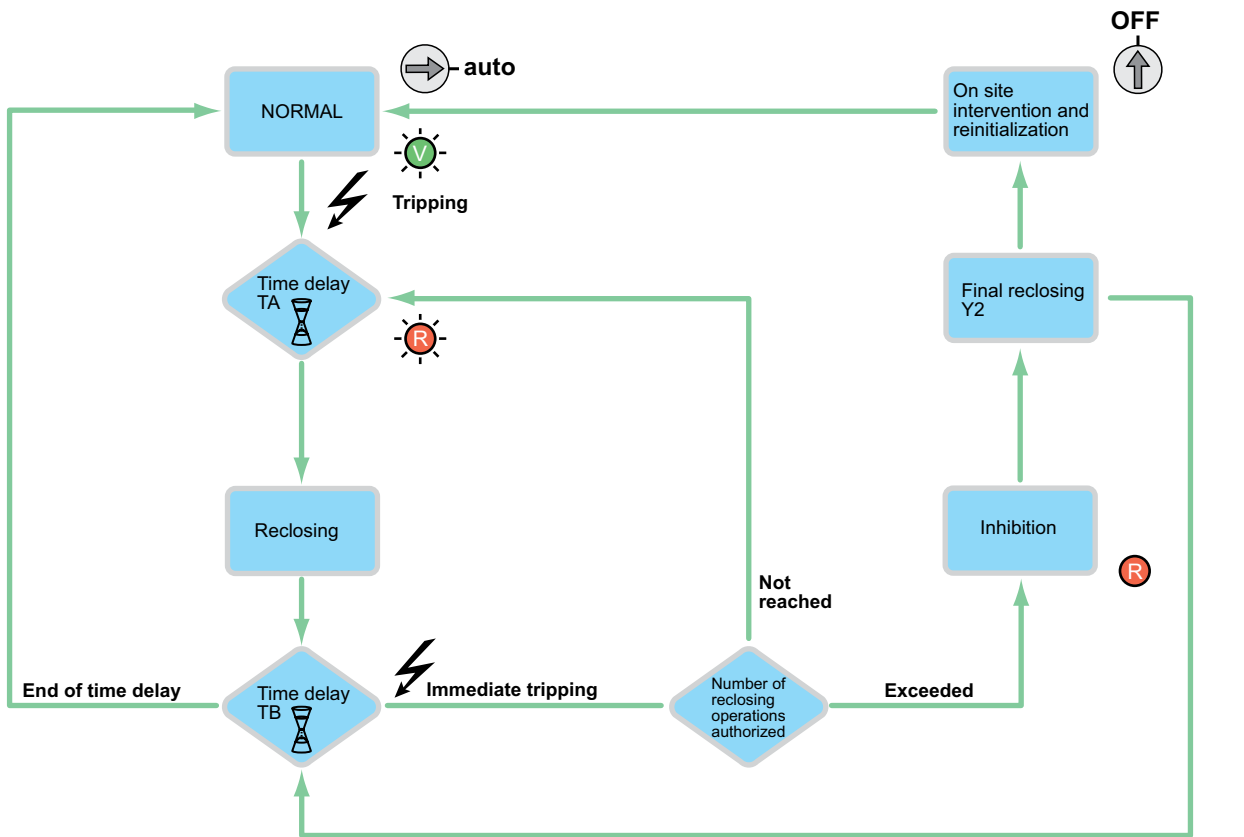

ARA automatic reclosers (cont.)

For iC60 circuit breakers
and iID residual current circuit breakers

PB10055-104

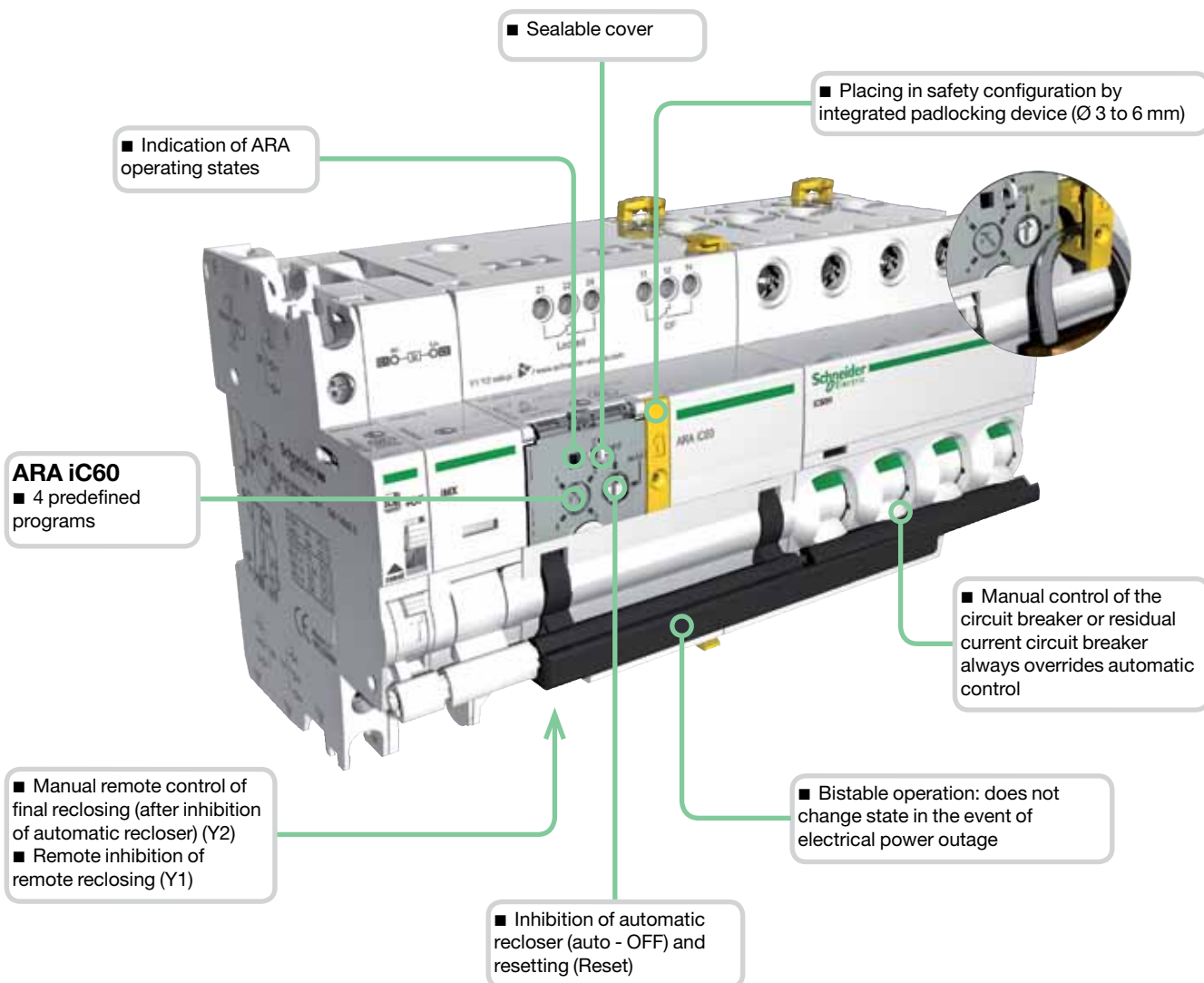

Control Remote control

ARA automatic reclosers (cont.)

For iC60 circuit breakers
and iID residual current circuit breakers

Connection

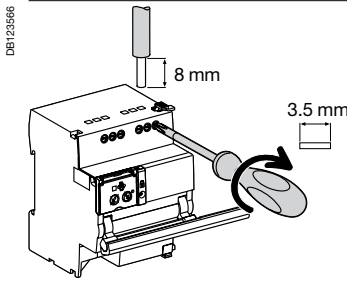
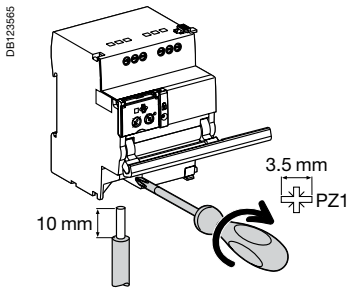

Terminal	Tightening torque	Copper cables		
		Rigid	Flexible	Flexible with ferrule
Power supply (N/P) Inputs (Y1/Y2)	1 N.m	0.5 to 10 mm ² 2 x 0.5 to 2 x 2.5 mm ²	0.5 to 6 mm ² 2 x 0.5 to 2 x 2.5 mm ²	0.5 to 4 mm ² 2 x 0.5 to 2 x 2.5 mm ²
Outputs (OF/Locked)	0.7 N.m	0.5 to 2.5 mm ² 2 x 0.5 to 2 x 1.5 mm ²	0.5 to 2.5 mm ² 2 x 0.5 to 2 x 1.5 mm ²	0.5 to 1.5 mm ² 2 x 0.5 to 2 x 1.5 mm ²

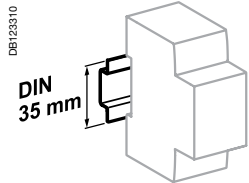

Clip on DIN rail 35 mm.

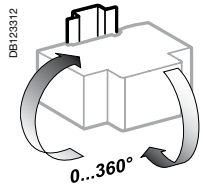

Indifferent position of installation.

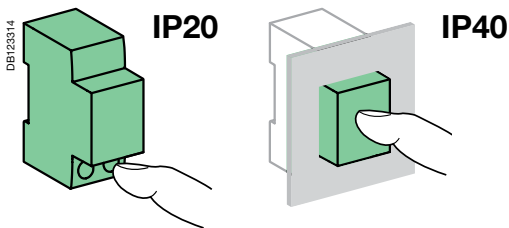

Technical data

Control circuit

Supply voltage (Ue) (N/P)	230 V AC, 50/60 Hz
Control voltage (Uc)	Type 1 inputs (Y1/Y2) 230 V AC (as per IEC 61131-2)
Min. duration of control order (Y2)	≥ 200 ms
Response time (Y2)	< 500 ms
Consumption	< 2 W

Endurance (O-C) (ARA combined with a circuit breaker)

Electrical	5000 cycles
------------	-------------

Indication / Remote control

Potential-free changeover contact output (OF/Locked)	Min.	24 V AC/DC, 10 mA
	Max.	230 V AC, 1 A
Input (Y1/Y2)	230 V AC	5 mA

Additional characteristics

Degree of protection (IEC 60529)	Device only	IP20
	Device in a modular enclosure	IP40 Insulation class II
Insulation voltage (Ui)	400 V	
Degree of pollution (IEC 60947)	3	
Rated impulse withstand voltage (Uimp)	6 kV	
Operating temperature	-25°C to +60°C	
Storage temperature	-40°C to +70°C	
Tropicalization	Treatment 2 (relative humidity of 93 % at +40°C)	

Weight (g)

Automatic reclosers	
Type	ARA
For 1P, 1P+N, 2P circuit breakers or iID residual current circuit breaker	440
For 3P, 4P circuit breakers	470

Dimensions (mm)

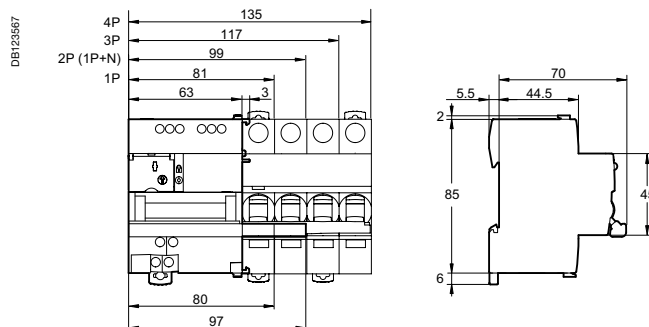

PB106253-40



ComReady

PB106251-40



6

The RCA remote control system allows:

- Remote electrical control (opening and closing) of circuit breakers with or without Vigi add-on RCD, with or without auxiliary.
- Circuit-breaker resetting after tripping, in accordance with safety principles and the regulations in force.
- Local control by operating handle.
- Circuit placing in safety configuration by padlocking.

2 choices of operation after tripping:

- A: Enabling of remote circuit-breaker resetting;
- B: Inhibition of remote resetting.

The version with Ti24 interface allows:

- Direct interfacing of remote control with a programmable logic controller (PLC), a supervision system and any other communication device, having inputs/ outputs in 24 V DC (control, OF and SD indications).
- Fast, reliable connection of the remote control to the Acti 9 Smartlink thanks to the prefabricated cables.
- Remote indication by "OF" potential-free contact.
- Provision of 2 operating modes, "1 and 3".

The iMDU auxiliary allows RCA control in 24/48 V AC/DC.

Catalogue numbers

RCA remote control			
Type			Width in 9 mm modules
For circuit breakers 1P, 1P+N, 2P	Voltage		
Without Ti24 interface	230 V AC, 50/60 Hz	A9C70112	7
With Ti24 interface	230 V AC, 50/60 Hz	A9C70122	7
For 3P, 4P circuit breakers			
Without Ti24 interface	230 V AC, 50/60 Hz	A9C70114	7
With Ti24 interface	230 V AC, 50/60 Hz	A9C70124	7
Auxiliaries		See module CA907000 and CA907002	

DE123813



Without Ti24 interface

DE123572



DE123573



Legend

Type	Application
OFF	All remote control inhibited
auto	
A	Circuit breaker remote reclosing after tripping allowed
B	Circuit breaker remote reclosing after tripping inhibited
Green indicator lamp	Remote control possible
Orange indicator lamp	Remote control impossible
1 (Ti24)	Mode 1
3 (Ti24)	Mode 3
Y1	Latched order local control
Y2	Impulse-type or latched order local control (depending on mode)
Y3	Latched order centralized control

Standard RCA

■ The orders received on terminals Y1 and Y2 are taken into account progressively in their order of arrival.

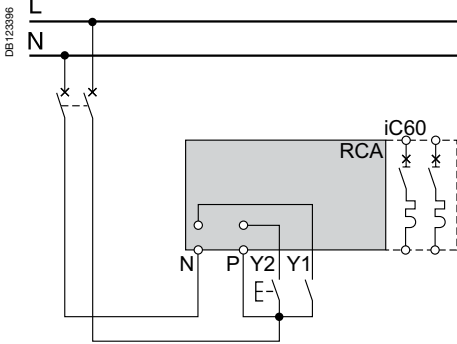

RCA Ti24

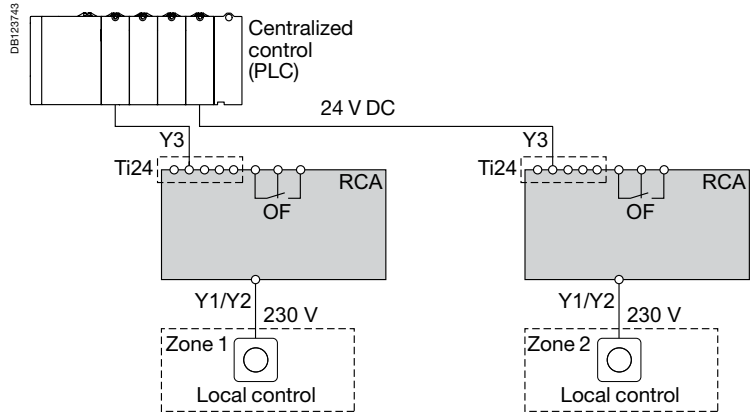

Mode 1: Locally or centrally controlled circuit-breaker opening/closing

- The orders come from various control points, and they are taken into account in their order of arrival
- Y1: Latched order local control
- Y2: Impulse-type local control
- Y3: Latched order centralized control

RCA Ti24 mode 1

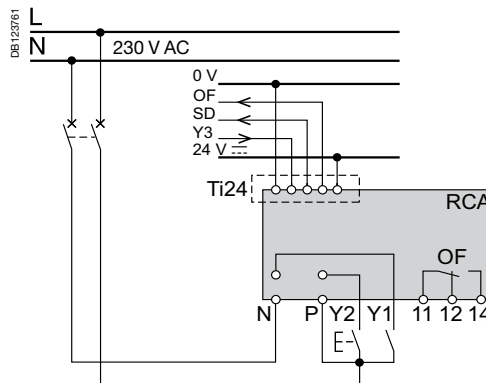

Mode 3: Centrally controlled opening/closing + local override

- 3 positions allowing a choice between override and centralized control:
- Y1: Latched order local control
- Y2: Latched order local control
- Y3: Latched order centralized control

RCA Ti24 mode 3

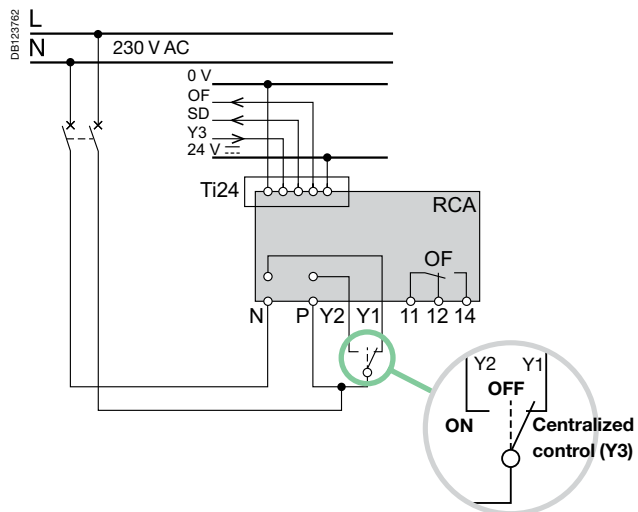

Control Remote control

RCA remote controls (cont.) For iC60 circuit breakers

DB123576

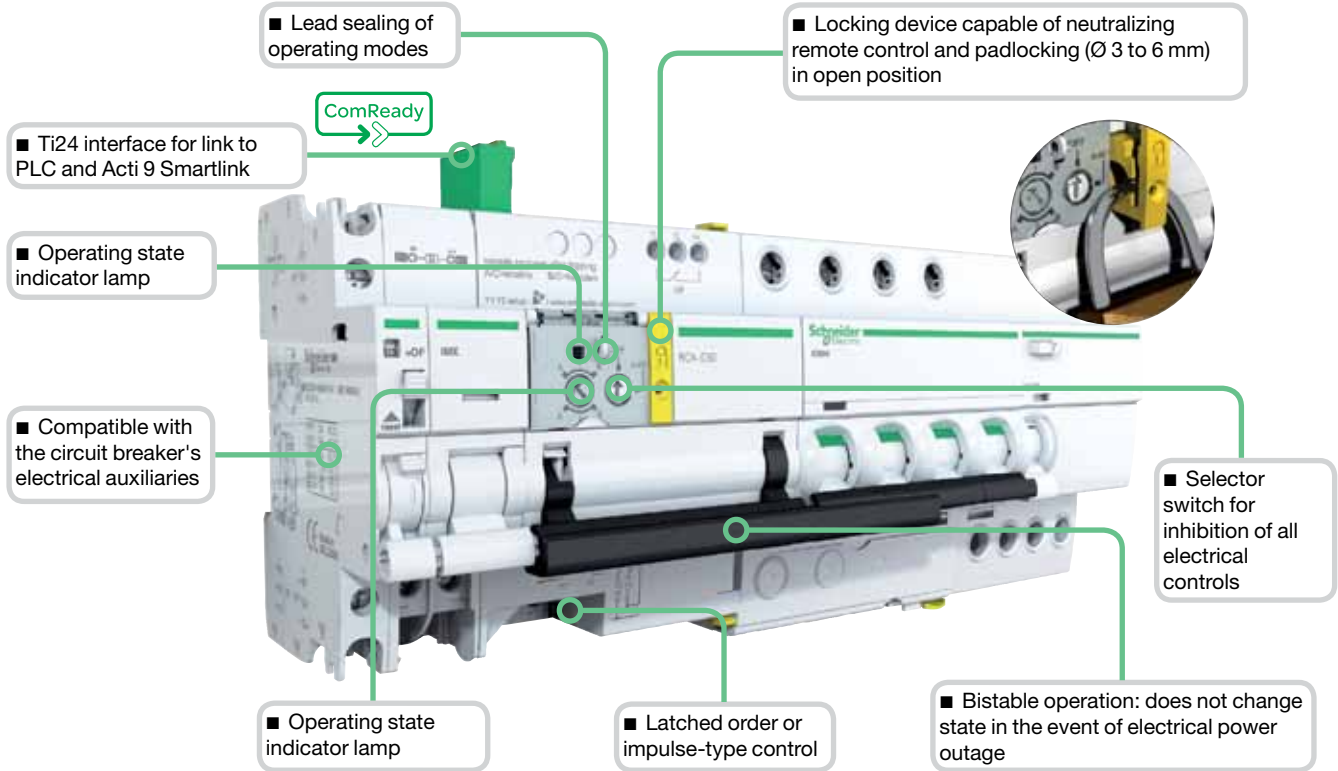

6

DB123763



DB123579



DB123578



Legend

Type	Application
+24VDC	V DC power supply
Y3	Latched order centralized control
SD	Circuit-breaker tripping information
OF	Control circuit state information (open/closed)
0V	V DC power supply
Y1	Latched order local control
Y2	Impulse-type or latched order local control (depending on mode)
N	230 V AC power supply
P	
OF	Circuit-breaker state indication contact (open/closed)



Indication auxiliaries Tripping auxiliaries RCA remote control iC60 circuit breaker Vigi iC60 add-on RCD

<p>3</p>	<p>2</p>	<p>1</p>		
No	1 (iSD or iOF or iOF/SD+OF or iOF+SD24)	1 (iMX or iMN) max.	<p>RCA</p>	<p>iC60</p>
1 iOF	1 (iSD or iOF or iOF/SD+OF)	No		<p>Vigi iC60</p>

Connection

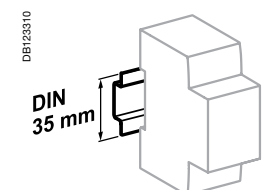
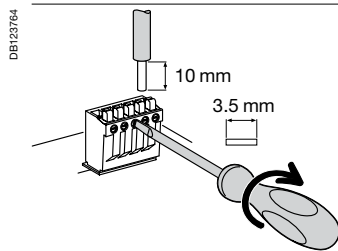
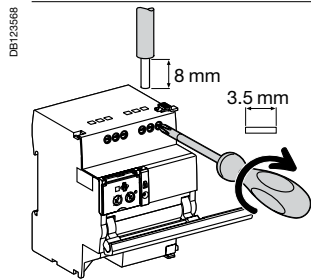
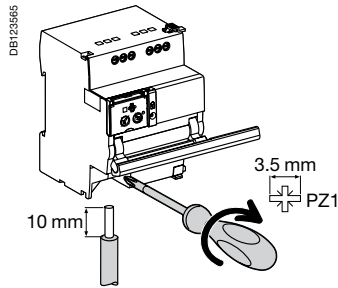

Clip on DIN rail 35 mm.

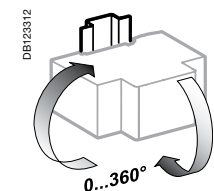

Indifferent position of installation.

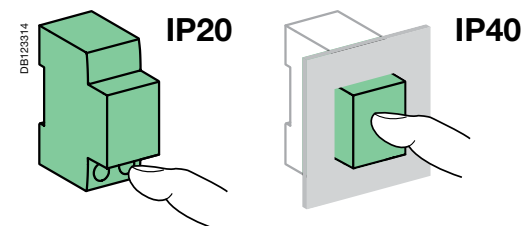

Without accessories

Terminal	Tightening torque	Copper cables		
		Rigid	Flexible	Flexible with ferrule
Power supply (N/P) Inputs (Y1/Y2)	1 N.m	0.5 to 10 mm ² 2 x 0.5 to 2 x 2.5 mm ²	0.5 to 6 mm ² 2 x 0.5 to 2 x 2.5 mm ²	0.5 to 4 mm ² 2 x 0.5 to 2 x 2.5 mm ²
Outputs (OF)	0.7 N.m	0.5 to 2.5 mm ² 2 x 0.5 to 2 x 1.5 mm ²	0.5 to 2.5 mm ² 2 x 0.5 to 2 x 1.5 mm ²	0.5 to 1.5 mm ² 2 x 0.5 to 2 x 1.5 mm ²
Ti24 interface	Spring-loaded terminals	0.5 to 1.5 mm ²	0.5 to 1.5 mm ²	-

Technical data

Control circuit		
Supply voltage (Ue) (N/P)		230 V AC, 50/60 Hz
Control voltage (Uc)	Type 1 inputs (Y1/Y2)	230 V AC (as per IEC 61131-2)
Min. duration of control order (Y2)		≥ 200 ms
Response time (Y2)		< 500 ms
Consumption		≤ 1 W
Thermal self-protection with automatic Reset against overheating of the control circuit due to an abnormal number of operations		
Endurance (O-C) (RCA combined with a circuit breaker)		
Electrical/Mechanical		10,000 cycles
Indication / Remote control		
Potential free changeover contact output (OF)	Min.	24 V AC/DC, 10 mA
	Max.	230 V AC, 1 A
Input (Y1/Y2)	230 V AC	5 mA
Ti24 interface (as per IEC 61131)		
Type 1 input (Y3)	24 V DC	5.5 mA
Output (OF and SD)	24 V DC	In max.: 100 mA
Additional characteristics		
Degree of protection (IEC 60529)	Device only	IP20
	Device in a modular enclosure	IP40 Insulation class II
Insulation voltage (Ui)		400 V
Degree of pollution (IEC 60947)		3
Rated impulse withstand voltage (Uimp)		6 kV
Operating temperature		-25°C to +60°C
Storage temperature		-40°C to +70°C
Tropicalization		Treatment 2 (relative humidity of 93 % at +40°C)

IEC/EN 61131-2

Acti 9 Smartlink Modbus Slave and Acti 9 Smartlink Ethernet are used to transfer data from Acti 9 devices to a PLC or monitoring system via the communication system:

- Modbus serial line for Acti 9 Smartlink Modbus Slave
- Modbus Ethernet TCP/IP or http for Acti 9 Smartlink Ethernet.

Functions

Data transmission between the network and Acti 9 devices

■ Circuit breakers, residual current circuit breakers, residual current devices:

- open/closed state
- tripped state
- number of opening/closing cycles
- number of tripping actions.

■ Contactors, impulse relays:

- opening control
- closing control
- open/closed state
- number of opening/closing cycles
- total period of operation of the load (device closed).

■ Remote controlled circuit breaker/Reflex iC60:

- opening control
- closing control
- open/closed state
- tripped state
- number of opening/closing cycles
- total period of operation of the load.

■ Power meters:

- number of pulses recorded
- pulse value setting (e.g. kWh)
- total consumption recorded
- estimate of power consumption.

■ Analog sensors only for Acti 9 Smartlink Ethernet:

- temperature sensor
- humidity sensor,
- CO₂ detector,
- optical detector
- ...

All the data are stored in memory: number of cycles, consumption, period of operation, even in the event of a power failure.

Acti 9 Smartlink can also exchange data with any device having 24 V DC digital inputs/outputs.

No configuration of the connected products is required.

When Acti 9 Smartlink is switched on, communication automatically adjusts to the Modbus Master or Ethernet (PLC, control station) communication parameters.

Installation

- Mounting in switchboards:
 - width 24 modules per row
 - minimum spacing between rails 150 mm.
- Mounting on
 - DIN rail, with mounting kit A9XMFA04
 - Linergy FM 80 A, with locking clips supplied
 - Linergy FM 200 A, with mounting kit A9XM2B04.

Test

- The communication and cabling test for the connected devices can be performed using Acti 9 Smart Test software

PB10797-47



DE40452



Acti 9 Smart Test software

- Electrical continuity test
- Functional testing of the devices
- Report printing
- Printing of a simplified diagram
- Project archiving
- Compatible with Windows XP, Windows 7, Windows 8
- To be download on: Schneider Electric web sites:
 - schneider-electric.com or
 - schneider-electric country web site



DE405140

DB406513





Acti 9 Smartlink Modbus Slave



Acti 9 Smartlink Ethernet

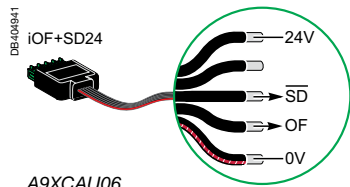

A9XCAU06



PB107804-43

Catalogue numbers

Acti 9 Smartlink			
Type		Set of	
Acti 9 Smartlink Modbus Slave		1	A9XMSB11
Supplied with	Modbus connector	1	
	24 V DC power supply connector	1	
	Locking clips for mounting on Linergy FM 80	2	
Acti 9 Smartlink Ethernet		1	A9XMEA08
Supplied with	Connector for 4-point analog output	1	
	Modbus connector	1	
	24 V DC power supply connector	1	
	Locking clips for mounting on Linergy FM 80	2	
Accessories			
USB cable link / Modbus for Acti 9 Smartlink test		1	A9XCATM1
Prefabricated cables			
With 2 connectors	Short: 100 mm	6	A9XCAS06
	Medium-sized: 160 mm	6	A9XCAM06
	Long: 870 mm	6	A9XCAL06
With 1 connector	Long: 870 mm	6	A9XCAU06
Connectors	5-pin connectors (Ti24)	12	A9XC2412
Mounting kit	DIN rail (4 feet, 4 straps, 4 adapters)	1	A9XMFA04
	Linergy FM 200 A (4 adapters)	1	A9XM2B04
Spare parts	Lock for Linergy FM 80 A (2 clips)	1	A9XMLA02



Connectable devices

With Ti24 interface		
Type	Reference	Description
iACT24	A9C15924	Low-level control and indication auxiliary for iCT contactors
iATL24	A9C15424	Low-level control and indication auxiliary for iTL impulse relays
iOF+SD24	A9A26897	Low-level indication auxiliary for iC60, IID, ARA, RCA, iSW-NA
OF+SD24	A9N26899	Low-level indication auxiliary for C60, C120, DPN, RCCB/ID, C60H-DC
RCA	See module CA904011	Remote control with Ti24 interface
Reflex iC60	See module CA904012	Reflex iC60 with Ti24 interface

Without Ti24 interface	
Power meters with pulse output, e.g. IEM2000T	
Impulse meters complying with the IEC 62053-21 standard	
24 V DC indicator lamps, Harmony XVL range	
All loads not exceeding 100 mA, 24 V DC	
Light sensitive switches: example IC2000	
Timers, thermostats, time switches, load shedding devices	
All 24 V DC auxiliary contacts, IEC 61131-2 type 1	
With analog outputs	
Temperature and humidity sensors, with a 0-10 V or 4-20 mA output	
CO ₂ and optical detectors, with a 0-10 V or 4-20 mA output	

Example of an installation



DB4-06505



Ethernet link
 ■ 10/100 MB Ethernet, Modbus TCP server

PBT13600-94



DB4-06544



DB4-06506

1 analog input channel
 ■ Example: temperature sensor connection

6

DB4-06508



Prefabricated cables
 ■ Simplified cabling
 ■ Fast and safe

DB4-06507



Modbus Communication
 ■ Up to 8 Acti 9 Smartlink Modbus Slave or others slaves Modbus connected

Connection to the Ethernet network

Acti 9 Smartlink Ethernet has an embedded web server that can be used to configure the connection to the Ethernet network

DB4-06573



■ Web Page available, to configure Acti 9 Smartlink Ethernet communication Ethernet parameter, to visualize or control data

Acti 9 Smartlink Ethernet

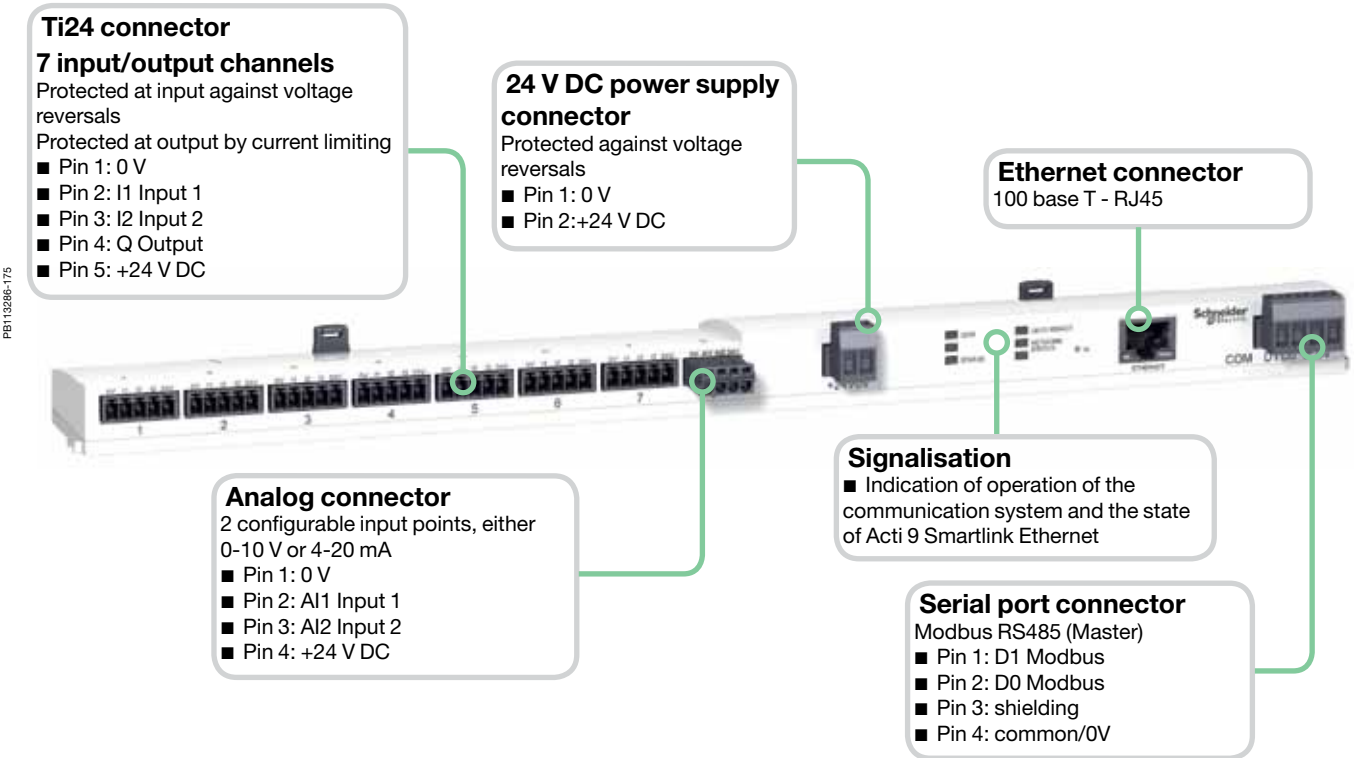

Acti 9 Smartlink Modbus Slave

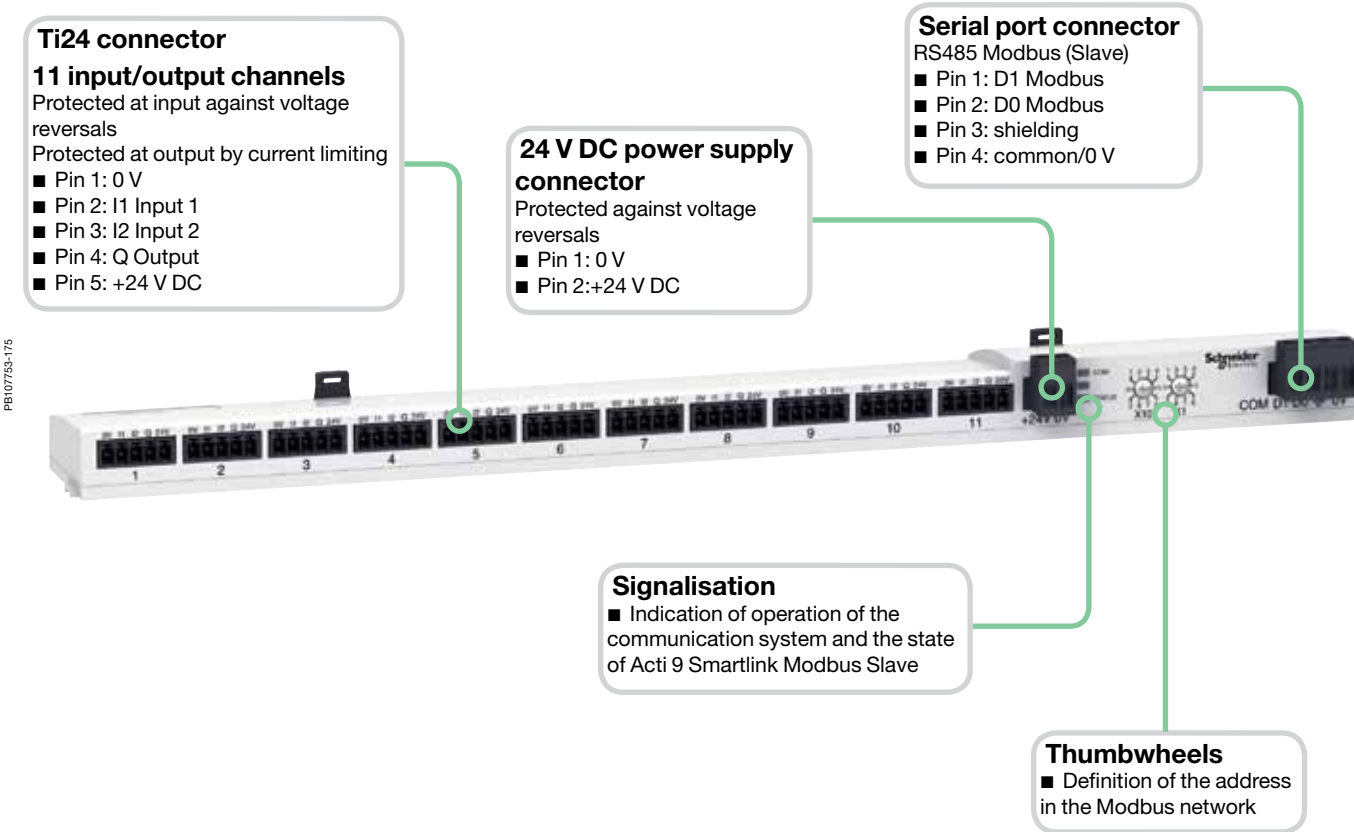

Common technical characteristics

Power supply		
Rated		24 V DC \pm 20 %
Maximum input current		1.5 A
Maximum inrush current		3 A
Meter		
Capacity		2 ³² pulses per input
Input characteristics		
Number of channels	Acti 9 Smartlink Modbus Slave	11 of 2-input channels
	Acti 9 Smartlink Ethernet	7 of 2-input channels
Type of input		Current collector Type 1 IEC 61131-2
Maximum cable length		500 m
Rated voltage		24 V DC
Voltage limits		24 V DC \pm 20 %
Rated current		2.5 mA
Maximum current		5 mA
Filtering time	In state 1	2 ms
	In state 0	2 ms
Isolation		No isolation between channels
Negative sequence voltage protection		Yes
Output characteristics		
Number of output channels	Acti 9 Smartlink Modbus Slave	11
	Acti 9 Smartlink Ethernet	7
Type of output		24 V DC 0.1 A current source
Maximum cable length		500 m
Rated voltage	Voltage	24 V DC
	Maximum current	100 mA
Filtering time	In state 1	2 ms
	In state 0	2 ms
Voltage drop (voltage in state 1)		1 V max
Maximum inrush current		500 mA
Leakage current		0.1 mA
Overvoltage protection		33 V DC
Environmental characteristics		
Temperature	Operating	-25°C ... +60°C (if vertical mounting, limited to 50°C)
	Storage	-40°C...+80°C
Tropicalization		Treatment 2 (relative humidity of 93% at 40°C)
Resistance to voltage dips		10 ms, class 3 as per IEC 61000-4-29
Degree of protection		IP20
Pollution degree		3
Altitude	Operating	0 ... 2000 m
Vibration resistance	As per IEC 60068.2.6	1 g / \pm 3.5 mm - 5 Hz to 300 Hz - 10 cycles
Shock resistance	As per IEC 60068.2.2 7	15 g / 11 ms
Immunity to electrostatic discharge	As per IEC 61000-4-2	Air: 8 kV Contact: 4 kV
Immunity to radiated magnetic fields	As per IEC 61000-4-3	10 V/m - 80 MHz to 3 GHz
Immunity to fast transients	As per IEC 61000-4-4	1 kV for inputs/outputs and Modbus communication. 2 kV for 24 DC power supply - 5 kHz - 100 kHz
Immunity to conducted magnetic fields	As per IEC 61000-4-6	10 V from 150 kHz to 80 MHz
Immunity to magnetic fields at mains frequency	As per IEC 61000-4-8	30 A/m
Resistance to corrosive atmospheres	As per IEC 60721-3-3	Level 3C2 on H ₂ S / SO ₂ / NO ₂ / Cl ₂
Fire resistance	For live parts	At 960°C 30 s / 30 s as per IEC 60 695-2-10 and IEC 60 695-2-11
	For other parts	At 650°C 30 s / 30 s as per IEC 60 695-2-10 and IEC 60 695-2-11
Salt spray test	As per IEC 60068.2.52	Severity 2
Environment		In compliance with the RoHS directive
Additional characteristics		
Duration of saving memory		10 years
Prefabricated cables characteristics		
Dielectric resistance		1 kV / 5 min
Minimum draw-out resistance		20 N

Acti 9 Smartlink Modbus Slave technical characteristics

Characteristics of the Modbus link		
Link	Modbus, RTU, RS485 serial connection	
Transmission	Transfer rate	9600 baud ... 19200 baud, self-adaptable
	Medium	Shielded cable, double twisted pair
Protocol	Master/Slave	
Type of device	Slave	
Modbus addressing range	1 to 99	
Maximum length of the bus	1000 m	
Type of bus connector	4-pin connector	

Acti 9 Smartlink Ethernet technical characteristics

Characteristics of the Ethernet link	
Link	10/100 MB Ethernet
Protocol	Modbus TCP server http (Web pages)
Address mode	Static and dynamic (supplied, by default, in dynamic mode)

Characteristics of Gateway	
Protocol	Modbus TCP/IP -> Modbus SL
Modbus slave number	8
Modbus addressing range	1 to 247

Characteristics of the Modbus Master link		
Link	Modbus serial connection, RTU, RS485	
Transmission	Transfer rate	9600 baud ... 19200 baud, self-adaptable
	Support	Shielded cable, double twisted pair
Maximum length of the bus	1000 m	
Type of bus connector	4-pin connector	

Characteristics of the analog inputs	
Number	2
Type	Separate configuration for each input, either 0-10 V or 4-20 mA
Measuring accuracy	1/100 full scale
Resolution	12 bits
Acquisition time	500 ms
Isolation	No isolation between channels
Power supply	0-24 V DC
Type of cable	Shielded cable, double twisted pair
Maximum cable length	30 m
Protection	Short-circuit protection

Dimensions (mm)

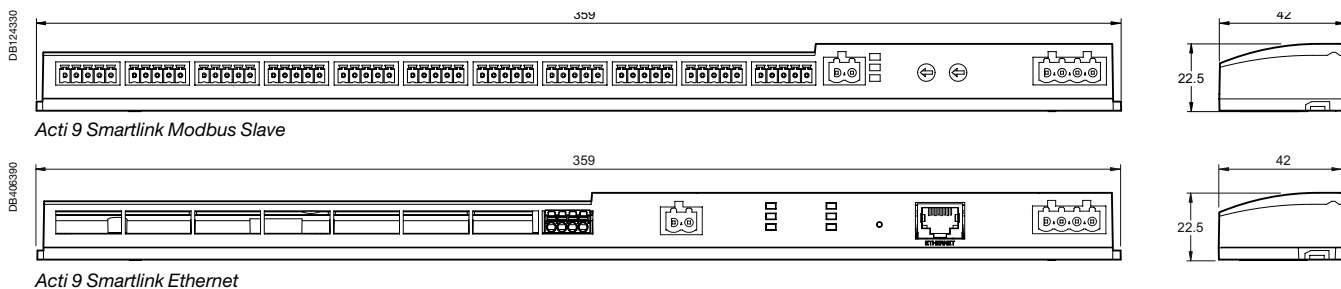

Weight (g)

Acti 9 Smartlink	
Type	
Acti 9 Smartlink Modbus Slave	195
Acti 9 Smartlink Ethernet	180

Connection

	Terminal	Tightening torque	Copper cables		
			Rigid	Flexible	Flexible with ferrule
<p>DB123560</p> <p>10 mm 0.4 x 2,5 mm</p> <p>Connector cat. no: A9XC2412</p>	Ti24 interface	Spring loaded terminal	DB123545	DB123553	DB123554
<p>DB406517</p> <p>24 V 0 V AI2 AI1 7 mm 0.6 x 3,5 mm</p>	Analog connector	0.8 N.m	0.1 to 1.5 mm ²	0.1 to 1.5 mm ²	0.1 to 1.5 mm ²
<p>DB124331</p> <p>0 V 24 V 7 mm 0.6 x 3,5 mm</p>	Power supply connector	0.8 N.m	0.2 to 1.5 mm ²	0.2 to 1.5 mm ²	0.2 to 1.5 mm ²
<p>DB124341</p> <p>0 V 3 D0 = A / Rx-, A / Tx- D1 = B / Rx+, B / Tx+ 7 mm 0.6 x 3,5 mm</p>	Modbus connector	0.8 N.m	0.25 mm ²	0.25 mm ²	0.25 mm ²
<p>DB405142</p> <p>1 2 $\le 50\text{ mm}$ $\le 20\text{ mm}$</p>					

6

iCT contactors **pages 7/2 to 7/13**
 iCT contactors pages 7/2 to 7/9
 Electrical auxiliaries pages 7/10 to 7/12
 Accessories page 7/13

Impulse relays **pages 7/14 to 7/28**
 iTL impulse relays pages 7/14 to 7/21
 iTLc, iTLm, iTLs with built-in auxiliary function page 7/19
 Electrical auxiliaries for iTL impulse relays pages 7/22 to 7/25
 Accessories for iTL impulse relays page 7/26
 iTL+ high-performance impulse relays pages 7/27 to 7/28

iIL indicator lights **page 7/29**

iPB pushbuttons **page 7/30**

iSW switches **pages 7/31 to 7/37**

iSSW linear switches **page 7/38**

iTR transformers **pages 7/39 to 7/40**

iSO bells and iRO buzzers **page 7/41**

STI isolatable fuse carriers **pages 7/42 to 7/45**

SBI fuse holder with indicator light **pages 7/46 to 7/47**

DIN rail selector switches iCMB, iCMD, iCME, iCMC, iCMV and iCMA **pages 7/48 to 7/50**

XB device holder **page 7/51**

Relays **pages 7/52 to 7/60**
 Time delay relays iRTA, iRTB, iRTC, iRTH, iRTL and iRTMF pages 7/54 to 7/55
 Interface relays iRBN and iRTBT page 7/56
 iRLI changeover and iERL extension relays page 7/57
 iRCP phase control, iRCI current control, iRCU voltage control and iRCC compressor control relays pages 7/58 to 7/59

Timers **pages 7/61 to 7/65**
 MIN, MINs, MINp and MINT pages 7/61 to 7/65

Time switches **pages 7/66 to 7/76**
 IHP, IH, IHH and ITA pages 7/66 to 7/69
 IHP and ITA pages 7/70 to 7/71
 IH and IHH pages 7/72 to 7/73
 Accessories pages 7/74 to 7/75
 Practical advice pages 7/76 to 7/78
 Connection page 7/79

Twilight switches **pages 7/81 to 7/86**
 IC100, 1C2000, IC2000P+, IC100k, abd IC Astro pages 7/81 to 7/83
 Accessories page 7/84
 Connection page 7/86

AMP/VLT/FRE digital meters **page 7/87**

Kilowatt-hour meters **pages 7/88 to 7/89**

Energy Meter Series iEM3000 **pages 7/90 to 7/92**

Power Meter Series PM3200 **pages 7/93 to 7/99**
 Functions and characteristics pages 7/93 to 7/96
 Installation and connection pages 7/97 to 7/99

CT current transformers **pages 7/100 to 7/108**

CH/CI counters **page 7/109**



EN 61095, IEC 1095

iCT contactors are available in two versions:

- Contactors without manually-operated
- Contactors with manually-operated.

The breadth of the iCT contactor range satisfies most application cases.
iCT contactors can be combined with auxiliary control, protection and indication functions.

Contactors

iCT 2P



manual control

iCT 4P



- iCT contactors can be used to remote control applications in alternative networks:
 - lighting, heating, ventilation, roller blinds, sanitary hot water
 - mechanical ventilation systems, etc
 - load-shedding of non-priority circuits

Indication iACTs

- This auxiliary allows indication or control of the "open" or "closed" position of the contactor power contacts

Interference filtering iACTp

- This auxiliary is an interference suppressor which limits overvoltages on the control circuit

Dual control iACTc

- Used to control a contactor in impulse-type mode or to combine latched or impulse-type control orders

Control and indication 24 V DC iACT24

- Allows control and indication of a 230 Vac contactor from the Acti 9 Smartlink or by a PLC, by 24 V DC signals
- Also allows control by a maintained signal

Time delay iATEt

- This auxiliary is used to time delay for iCT and iTL. According to cabling, there are 5 possible time delay types:
 - 1 for iTL
 - 4 for iCT

Function type A: late closing

- Delay energizing of contactor

Function type B: time delay

- Energize the contactor by closing a push button
- The time delay starts as soon as the control contacts are closed

Function type C: late opening

- Energize the contactor by closing a push button
- The time delay starts when the control contacts are opened

Function type H: fixed time operation

- Operate the contactor for a pre-determined time from the moment of energizing

7

Contactors

Contactors auxiliaries

		Choice of 50 Hz contactors										
Type		Contactor						Manually-operated contactors				
Rating	A	16	20	25	40	63	100	16	25	40	63	
Auxiliaries		Contactors that can be equipped with auxiliaries										
iACTs indication auxiliary		Yes	Yes	Yes				Yes				
iACTp protection auxiliary	By yellow clips	No	No	Yes				No	Yes			
iACTc, iATEt control auxiliary	By yellow clips	No	No	Yes				No	Yes			
iACT24 control auxiliary		No	No	Yes (for contactors 230 V - 50 Hz)				No	Yes (for contactors 230 V - 50 Hz)			

Technical Section 11

Dimensions Section 12

PP106115-39

Yellow clip

■ Clip-on system for electrical and mechanical connections between contactors ≥ 25 A and their auxiliaries

■ Insulated terminals IP20

■ Minimum noise

■ Large circuit labeling area

■ Mechanical contact position indicator

■ Consistent with the entire Acti 9 offer and with all types of lighting

■ Manually-operated contactors have a 4-position selector switch on their front face:

- automatic operating mode
- temporary "ON" override
- permanent "ON" override: used to lock the contactor in the ON position during installation maintenance
- shutdown

Catalogue numbers

iCT contactors - 50 Hz

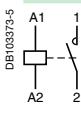
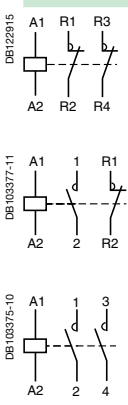
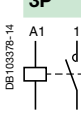
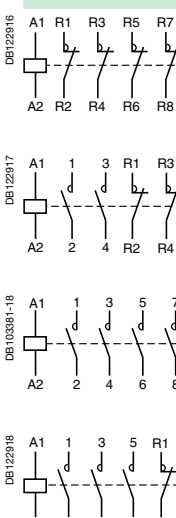
Type						Width in 9 mm modules	
1P	Rating (In)		Control voltage (V AC) (50 Hz)	Contact	A9C		
	AC7a	AC7b					
	16 A	6 A	12	1NO	A9C22011	2	
			24	1NO	A9C22111	2	
			48	1NO	A9C22211	2	
			220	1NO	A9C22511	2	
			230...240	1NO	A9C22711	2	
			230...240	1NO	A9C20531	2	
	25 A	8.5 A	220	1NO	A9C20731	2	
			230...240	1NO	A9C20731	2	
	16 A	6 A	12	2NO	A9C22012	2	
			24	2NO	A9C22112	2	
			48	2NO	A9C22212	2	
			220	2NO	A9C22512	2	
			230...240	2NO	A9C22712	2	
			230...240	2NO	A9C20532	2	
		20 A	-	230...240	1NO+1NC	A9C22015	2
				24	1NO+1NC	A9C22115	2
				220	1NO+1NC	A9C22515	2
				230...240	1NO+1NC	A9C22715	2
				230...240	2NO	A9C22722	2
				230...240	2NO	A9C20532	2
		25 A	8.5 A	24	2NO	A9C20132	2
				48	2NO	A9C20232	2
				220	2NO	A9C20532	2
				230...240	2NO	A9C20732	2
				220	2NC	A9C20536	2
				230...240	2NC	A9C20736	2
	40 A	15 A	220...240	2NO	A9C20842	4	
	63 A	20 A	24	2NO	A9C20162	4	
			220...240	2NO	A9C20862	4	
	100 A	-	220...240	2NO	A9C20882	6	
	16 A	6 A	220...240	3NO	A9C22813	4	
	25 A	8.5 A	220...240	3NO	A9C20833	4	
	40 A	15 A	220...240	3NO	A9C20843	6	
	63 A	20 A	220...240	3NO	A9C20863	6	
				220...240	3NO	A9C20863	6
	16 A	6 A	24	4NO	A9C22114	4	
			220...240	4NO	A9C22814	4	
			220...240	2NO+2NC	A9C22818	4	
	20 A	-	220...240	4NO	A9C22824	4	
	25 A	8.5 A	24	4NO	A9C20134	4	
			220...240	4NO	A9C20834	4	
			24	4NC	A9C20137	4	
			220...240	4NC	A9C20837	4	
			220...240	2NO+2NC	A9C20838	4	
			220...240	2NO+2NC	A9C20838	4	
	40 A	15 A	220...240	4NO	A9C20844	6	
		63 A	20 A	220...240	4NC	A9C20847	6
	24			4NO	A9C20164	6	
	220...240			4NO	A9C20864	6	
	24			4NC	A9C20167	6	
	220...240			4NC	A9C20867	6	
	220...240			4NC	A9C20867	6	
		100 A	-	220...240	2NO+2NC	A9C20868	6
220...240	3NO+1NC			A9C20869	6		
220...240	4NO			A9C20884	12		

7

Catalogue numbers

iCT manual control contactor 50 Hz							
Type	Rating (In)		Control voltage (V AC) (50/60 Hz)	Contact		Width in 9 mm modules	
	AC7a	AC7b					
	16 A	6 A	220	2NO	A9C23512	2	
			230...240	2NO	A9C23712	2	
			220	1NO+1NC	A9C23515	2	
			230...240	1NO+1NC	A9C23715	2	
	25 A	8.5 A	24	2NO	A9C21132	2	
			220...240	2NO	A9C21532	2	
			24	2NO	A9C21142	2	
			220...240	2NO	A9C21842	4	
40 A	15 A	24	2NO	A9C21162	4		
		220...240	2NO	A9C21862	4		
	25 A	8.5 A	220...240	3NO	A9C21833	4	
	40 A	15 A	220...240	3NO	A9C21843	6	
		25 A	8.5 A	24	4NO	A9C21134	4
		220...240	4NO	A9C21834	4		
40 A	15 A	24	4NO	A9C21144	6		
		220...240	4NO	A9C21844	6		
63 A	20 A	24	4NO	A9C21164	6		
		220...240	4NO	A9C21864	6		

Operation (Manual control contactor)

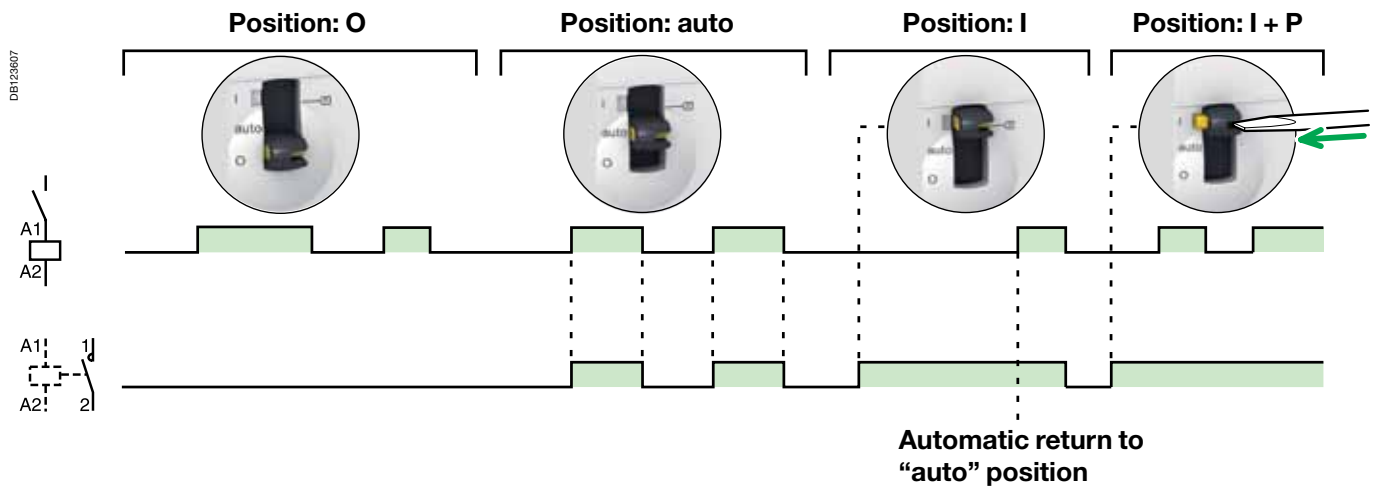

Connection

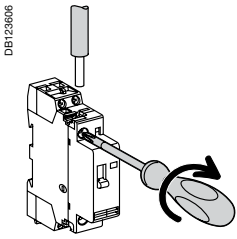

Type	Rating	Length tripping	Circuit	Tightening torque	Copper cables		
					Rigid	Flexible or ferrule	
iCT	PZ1: 4 mm	16 - 100 A	9 mm	Control	0.8 N.m	1.5 to 2.5 mm: 2 x 1.5 mm ²	1.5 to 2.5 mm: 2 x 2.5 mm ²
	PZ2: 6 mm	40 A - 63 A	14 mm	3.5 N.m	6 to 25 mm ²	6 to 16 mm ²	
							100 A
iACTs, iACTp, iACTc, iATEt	PZ1: 4 mm	-	9 mm	-	0.8 N.m	1.5 to 2.5 mm: 2 x 1.5 mm ²	1.5 to 2.5 mm: 2 x 2.5 mm ²

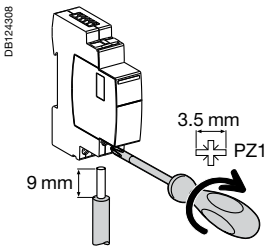

Type	Terminals	Tightening torque	Copper cables		
			Rigid	Flexible	Flexible or ferrule
iACT24	Power supply (N/P) Input (Y1/Y2)	1 N.m	0.5 to 10 mm ² 2 x 0.5 to 2 x 2.5 mm ²	0.5 to 6 mm ² 2 x 0.5 to 2 x 2.5 mm ²	0.5 to 4 mm ² 2 x 0.5 to 2 x 2.5 mm ²

Ti24 connector connection

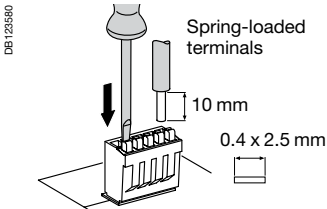

Type	Catalogue numbers	Copper cables	
		Rigid	Flexible
Ti24 Interface	A9XC2412	1 x 0.5 to 1.5 mm ²	1 x 0.5 to 1.5 mm ²

Ti24 prefabricated cables connection

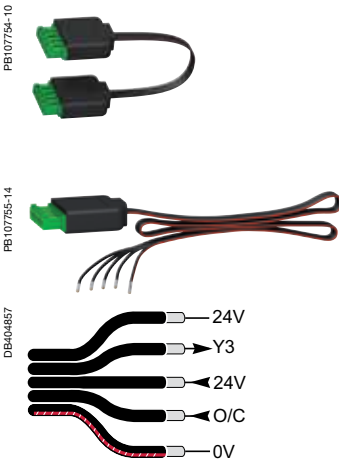

Type	Catalogue numbers	Length
Connection for Acti 9 Smartlink		
6 short prefabricated	A9XCAS06	100 mm
6 medium-sized prefabricated	A9XCAM06	160 mm
6 long prefabricated	A9XCAL06	870 mm
Connection for PLC type terminals		
6 long prefabricated on a single side	A9XCAU06	870 mm

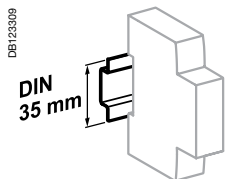

Clip on DIN rail 35 mm.

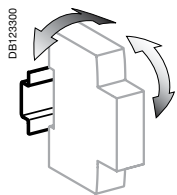

± 30° vertical.

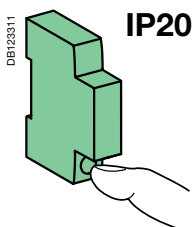

IP20

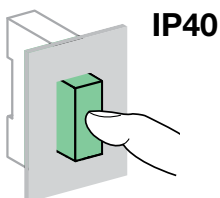

IP40

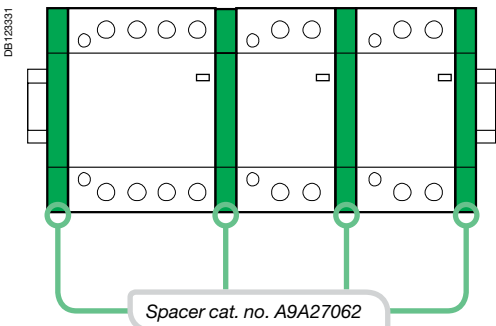

Technical data

Power circuit

Voltage rating (Ue)	1P, 2P	250 V AC
	3P, 4P	400 V AC
Frequency	50 Hz	
Type of load	See technical section	

Endurance (O-C)

Electrical	100,000 cycles
Maximum number of switching operation a day	100

Additional characteristics

Insulation voltage (Ui)	500 V AC	
Pollution degree	2	
Rated impulse withstand voltage (Uimp)	2.5 kV (4 kV for 12/24/48 V AC)	
Degree of protection (IEC 60529)	Device only	IP20
	Device in modular enclosure	IP40
Operating temperature	-5°C to +60°C ⁽¹⁾	
Storage temperature	-40°C to +70°C	
Tropicalization (IEC 60068-1)	Treatment 2 (relative humidity 95 % at 55°C)	

ELSV compliance (Extra Low Safety Voltage) for 12/24/48 V AC versions

The product control conforms to the SELV (safety extra low voltage) requirements

(1) In the case of contactor mounting in a enclosure for which the interior temperature is in range between 50°C and 60°C, it is necessary to use a spacer, cat. no. A9A27062, between each contactor



Mounting accessories

7	Sealable screw shields for top and bottom	3P, 4P 25 A	A9A15921
		2P 40/63 A	A9A15922
		3P, 4P 40/63 A	A9A15923
8	9 mm spacer		A9A27062
9	Yellow clips		A9C15415
10	Clip-on terminal markers	see module	CA907001

Auxiliaries

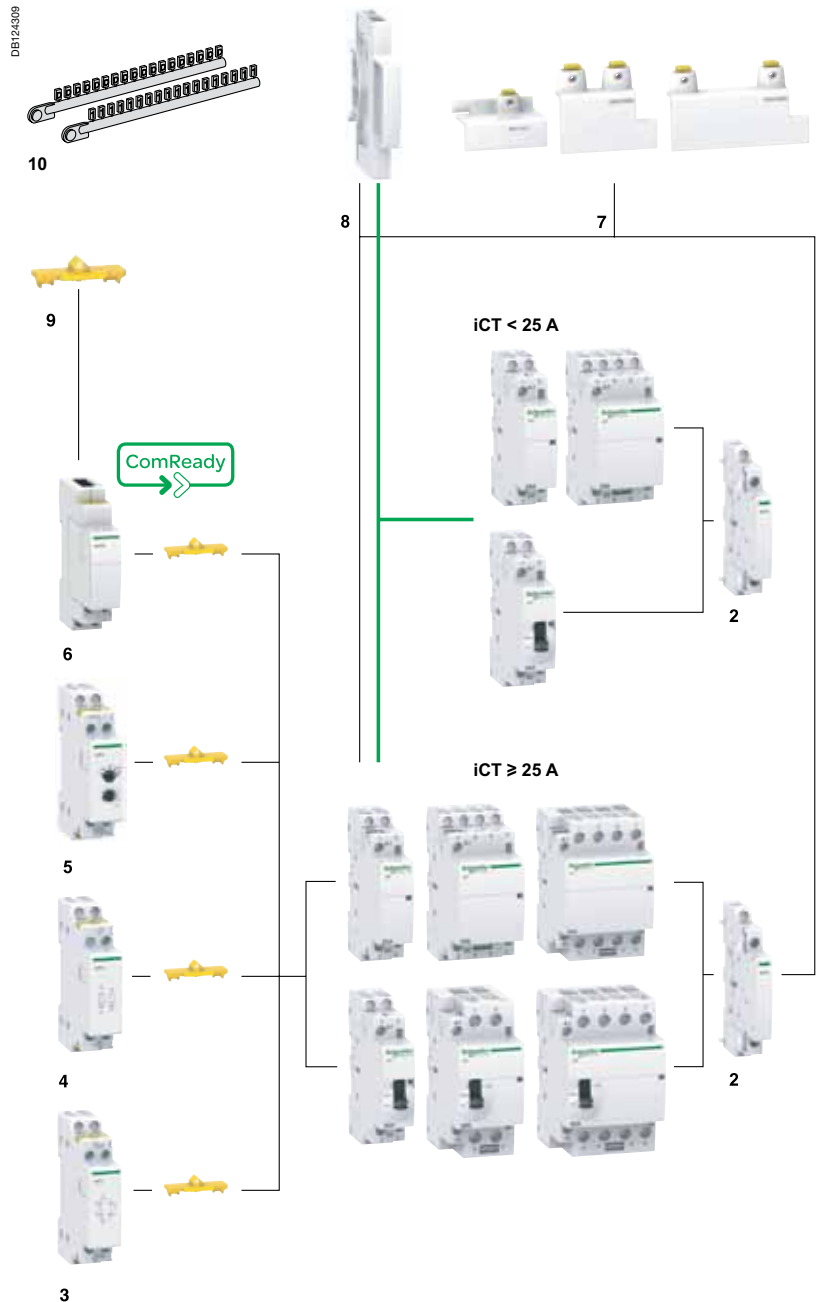
Indication			
2	iACTs	1NO + 1NC	A9C15914
		1CO	A9C15915
		2NO	A9C15916
Double control inputs			
3	iACTc	230 V AC	A9C18308
		24 V AC	A9C18309
Coil suppression blocs			
4	iACTp	12...48 V AC	A9C15919
		48...127 V AC	A9C15918
		220...240 V AC	A9C15920
Time delay			
5	iATEt	24...240 V AC	A9C15419
Control and indication			
6	iACT24	230 V AC	A9C15924

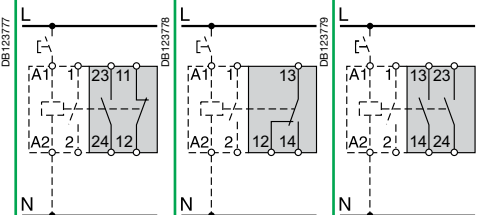
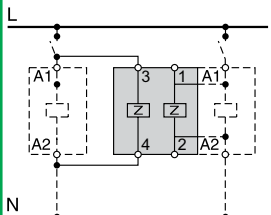
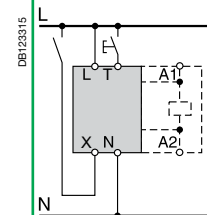

		Indication			Protection			Control	
Auxiliaries		iACTs			iACTp			iACTc	
Type		Indication			Interference filtering			Impulse/latched control	
		With Open/Close auxiliary contact			2 protection circuits				
									
Function		<ul style="list-style-type: none"> This auxiliary allows indication of the "open" or "closed" position of the contactor power contacts 			<ul style="list-style-type: none"> This auxiliary is an interference suppressor which limits overvoltages on the control circuit 			<ul style="list-style-type: none"> This auxiliary, combined with contactors, enables them to be controlled by 2 order types: <ul style="list-style-type: none"> impulse order for local control (input T) latched order for centralised control (input X) the last order received takes priority 	
Wiring diagrams									
Mounting		<ul style="list-style-type: none"> Mounted to the right of iCT 			<ul style="list-style-type: none"> Mounted to the left of iCT by yellow clips⁽¹⁾ By wires 			<ul style="list-style-type: none"> Mounted to the left of iCT by yellow clips⁽¹⁾ 	
Use		-			<ul style="list-style-type: none"> The iACTp has 2 separate and identical circuits, allowing it to be combined with 2 different one on the iCT the other by wires 			<ul style="list-style-type: none"> Mains power outages: <ul style="list-style-type: none"> < 70 ms: keeps its initial status > 80 ms: reset put back into operation by manual operation on input X or T. Minimum impulse duration: 250 ms 	
Catalogue numbers		A9C15914	A9C15915	A9C15916	A9C15918	A9C15919	A9C15920	A9C18308	A9C18309
Technical specifications									
Control voltage (U _e)	V AC	24...240			48 ...127	12 ...48	220 ...240	230...240	24...48
	V DC	24...130			-				
Control voltage frequency	Hz	50/60			50/60			50/60	
Width in 9 mm modules		1			2			2	
Auxiliary contact (breaking capacity)		<ul style="list-style-type: none"> Minimum: 10 mA at 24 V DC/AC - cos φ = 1 Maximum: <ul style="list-style-type: none"> 5 A at 240 V AC - cos φ = 1 1 A at 130 V DC 			-			-	
Number of contacts		1NO + 1NC	1CO	2NO	-				
Operating temperature	°C	-5°C to +50°C							
Storage temperature	°C	-40°C to +70°C							
Consumption		-			-			OFF load: 3 VA Inrush ⁽²⁾ : 2 VA Holding ⁽²⁾ : 0.2 VA	

(1) Electrical and mechanical link.
 (2) Maximum consumption of all contactors controlled.

Control (cont.)

iATEt

Time delay



- This auxiliary is used to time delay for iCT and iTL. According to cabling, there are 5 possible time delay types:
 - 1 for iTL
 - 4 for iCT.

Function type A: late closing

- Delay energizing of contactor.

Function type B: time delay

- Energize the contactor by closing a push button.
- The time delay starts as soon as the control contacts are closed.

Function type C: late opening

- Energize the contactor by closing a push button.
- The time delay starts when the control contacts are opened.

Function type H: fixed time operation

- Operate the contactor for a pre-determined time from the moment of energizing.

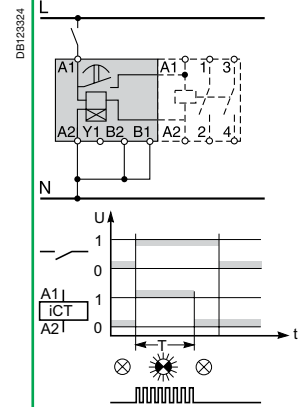
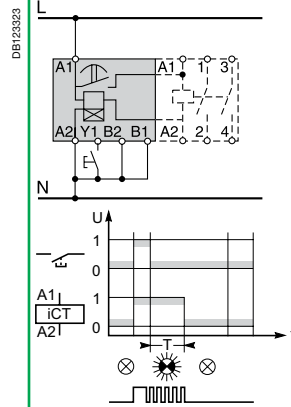
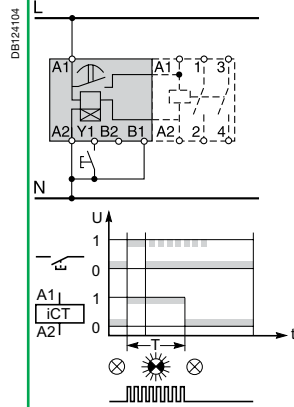
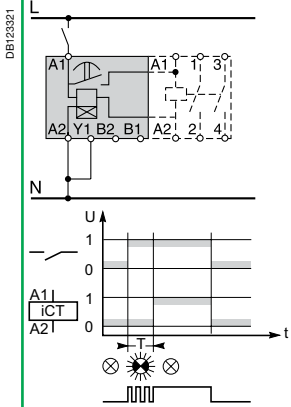

- Mounted to the left of iCT by yellow clips⁽¹⁾

A9C15419

24...240

24...110

50/60

2

-20°C to +50°C

-40°C to +80°C

Off-load: 5 VA
Inrush⁽²⁾: 3 A
Holding⁽²⁾: 0.2 A

Control and indication

Auxiliary	iACT24
Type	Control and indication 24 V DC

With Ti24 connector



Function	<ul style="list-style-type: none"> ■ This auxiliary allows a contactor to be interfaced with the Acti 9 Smartlink interface or a programmable logic controller (PLC) in 24 V DC (control, O/C indication) ■ 230 V AC control
-----------------	--

Wiring diagrams	<p>Wiring with exclusive selector 230 V AC control (Y1 = 0) / 24 V DC control (Y1 = 1)</p>	<p>Wiring for non-exclusive 230 V AC and 24 V DC controls</p>
------------------------	--	---





Mounting	<ul style="list-style-type: none"> ■ To the left of the iCT contactor using the yellow clips⁽¹⁾. ■ When an iACT24 is used, the A1/A2 terminals of the contactors should not be wired. Only the yellow clips integral with the iACT24 should be used for connection to the coil.
-----------------	--

Utilization	<ul style="list-style-type: none"> ■ 230 V AC interface: <ul style="list-style-type: none"> □ Y1: enabling of 24 V DC control (Y1 = 1) or inhibition of 24 V DC control (Y1 = 0). □ Y2: 230 V pulse control ■ "Ti24" 24 V DC interface: <ul style="list-style-type: none"> □ Y3: 24 V DC control of iCT closing on rising edge and opening on falling edge □ reading of the contactor status (opened or closed) from the position of the integrated O/C auxiliary contact □ monitoring of connection of the "Ti24" terminal block by the upstream system (PLC, supervision system) via the 24 V terminal (in the centre of the Ti24 terminal block)
--------------------	--

Catalogue numbers	A9C15924
--------------------------	-----------------

Technical specifications		
Control voltage (U _e)	V AC	230, +10 %, -15 % (Y2)
	V DC	24, ± 20 % (Y3)
Control voltage frequency	Hz	50/60
Insulation voltage (U _i)	V AC	250
Rated impulse withstand voltage (U _{imp})	kV	8 (OVC IV)
Pollution degree		3
Degree of protection		IP20B device only
		IP40 device in modular enclosure
Width in 9 mm modules		2
Auxiliary contact (O/C) Ti24		24 V DC protected output, min. 2 mA, max. 100 mA
Contact		1 O/C operating category AC 14
Operating temperature	°C	-25°C to +60°C
Storage temperature	°C	-40°C to +80°C
Consumption		<1 W
Standard		IEC/EN 60947-5-1

(1) Mechanical and electrical link.

Security					
Accessories	Sealable screw shields			Yellow clips	Spacer
	 PB104485-15	 PB104485-15	 PB104487-15	 PB106143-10	 PB104483-40
Function	<ul style="list-style-type: none"> ■ Designed to cover terminals to avoid contact with device screws. ■ Allow sealing 			<ul style="list-style-type: none"> ■ Ensure the mechanical and/or electrical link between contactors and their auxiliaries. 	<ul style="list-style-type: none"> ■ Required to reduce temperature rise of modular devices installed side by side. ■ Recommended to separate electronic devices (thermostat, programmable clock, etc.) from electromechanical devices (relays, contactors).
	■ For iCT: 3P, 4P - 25 A	■ For iCT: 2P - 40/63 A	■ For iCT: 3P, 4P - 40/63 A	■ For iCT: ≥ 25 A	
Use	■ Bag of 10 upstream/10 downstream			■ Bag of 10	■ Bag of 5
Catalogue numbers	A9A15921	A9A15922	A9A15923	A9C15415	A9A27062
Technical specifications					
Width in 9 mm modules	4	4	6	–	1
Number of poles	3P, 4P	2P	3P	–	–

IEC/EN 60669-2-2
iTLs: IEC/EN 60947-5-1

> Impulse relays



iTL
 ■ The impulse relays are used to control, by means of pushbuttons, lighting circuits consisting of:
 □ incandescent lamps, low-voltage halogen lamps, etc. (resistive loads)
 □ fluorescent lamps, discharge lamps, etc. (inductive loads)

> Remote indication



iTLs
 ■ Allows remote indication of its operating state (open/closed)

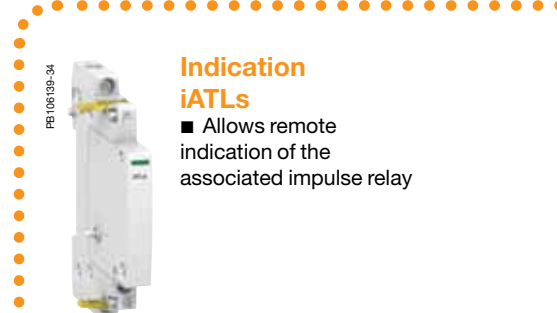

Indication iATLs
 ■ Allows remote indication of the associated impulse relay

7

> Centralised control



iTLc
 ■ Allows centralised control of a group of TLC impulse relays, whilst at the same time retaining local impulse-type control



Centralised control iATLc
 ■ Used for centralised control, thanks to a "pilot line", of a group of impulse relays controlling separate circuit, while at the same time maintaining local individual control of each impulse relay

> Latched control



iTLm
 ■ Operated by latched orders from a changeover contact (switch, time switch, thermostat). Manual control does not work



Latched control iATLm
 ■ Controls the associated impulse relay by latched orders from a changeover contact



Impulse relays are used:

- Closing of the impulse relay pole(s) is triggered by an impulse on the coil.
- Having two stable mechanical positions, the pole(s) will be opened by the next impulse. Each impulse received by the coil reverses the position of the pole(s).
- Can be controlled by an unlimited number of pushbuttons.
- Zero energy consumption.

PB106131-34



Changeover contact iTLi

- This impulse relay has a changeover contact

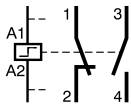

PB106134-34



Extensions iETL

- Used to increase the number of impulse relay poles
- Can be installed on the iTL, iTLi, iTLc, iTLm and iTLs

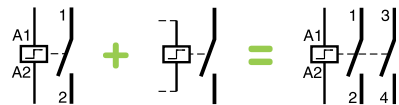

PB106140-34



Centralised control + indication iATLc+s

- Used for centralised control, thanks to a "pilot line", of a group of impulse relays controlling separate circuit, while at the same time maintaining local individual control of each impulse relay
- Remote indication of the mechanical status of each relay

PB106136-34



Multi-level centralised control iATLc+c

- Allows centralised control of a group of iTLc or "iTL + ATLc" impulse relays

PB107752-34



ComReady

Control and indication 24 V DC iATL24

- Allows control and indication of a 230 V AC impulse relay from the Acti 9 Smartlink or by a PLC, by 24 V DC signals
- Also allows control by a pulsed signal

PB106125-34



Time delay iATEt

- Combined with an impulse relay, it automatically disconnects the circuit after a preset time

PB106141-34



Control iATLz

- Must be used when installing several illuminated PBs in parallel to control an impulse relay (prevents operating malfunctions)

PB106142-63



Step by step control iATL4

- Allows step-by-step control of two circuits via a single pushbutton

Mounting accessories

11	Yellow clips	A9C15415	
12	9 mm spacer	A9A27062	
13	Clip-on terminal markers	see module	CA907001

DB123631



Auxiliaries

Centralised control			
2	iATLc ^{(1),(3)}	24...240 V AC	A9C15404
Indication			
3	iATLs ⁽¹⁾	24...240 V AC	A9C15405
Centralised control + indication			
4	iATLc+s ⁽³⁾	24...240 V AC	A9C15409
Multi-level centralised control			
5	iATLc+c ^{(2),(3)}	24...240 V AC	A9C15410
Step by step control			
6	iATL4	230 V AC	A9C15412
Control by illuminated push-buttons			
7	iATLz	130...240 V AC	A9C15413
Latched control			
8	iATLm ⁽¹⁾	12...240 V AC	A9C15414
Time delay control			
9	iATEt ⁽⁴⁾	24...240 V AC	A9C15419
Control and indication			
10	iATL24	230 V AC	A9C15424

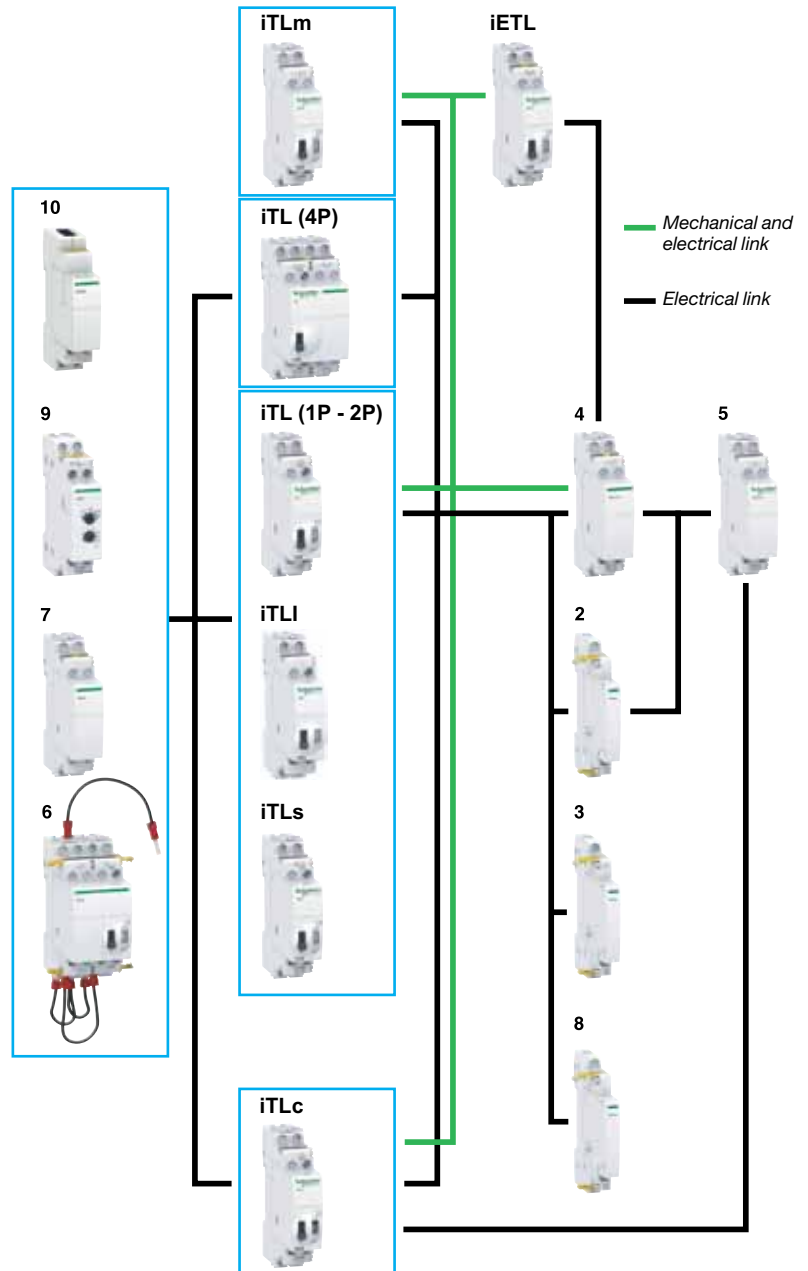

(1) The iATLc, iATLs and iATLm 9 mm auxiliaries are used by themselves to the right of an impulse relay.

(2) Connection by traditional cabling. The iATLc+c must be mounted to the right of an iATLc+s or an iATLc.

(3) The centralised control functions (iTLc, iATLc, iATLc+s, iATLc+c) only operate on AC voltage networks.

(4) iATEt: control voltage: 24...240 V AC, 24...110 V DC.

PE108128-41

Yellow clip

- A simple clip-on system for flexible auxiliaries combination and improved robustness
- For electrical and mechanical connections

- Insulated terminals IP20

- Large circuit labeling area

- Built-in or optional auxiliary function: state indication, centralised control, latched control, control for illuminated pushbutton, step-by-step control, time delay

- Consistent with the entire Acti 9 offer and with all types of lighting

- Disconnection of remote control by selector switch (except for 4P single-piece iTL) for maintenance operation

- Manual controls on front face: direct and priority manual control by O-I toggle
- Mechanical contact position indicator

		Choice impulse relays auxiliaries																					
Type		Standard iTL						Changeover iTLI						iTLc centralised control		iTLm control on latched order		iTLs remote indication					
Rating	A	16	32					16	24					16	24		16	24					
Control voltage	V AC	230/240	130	48	24	12	230/240	230/240	130	48	24	12	230/240	48	24	230/240	48	24	230/240	48	24		
	V DC	110	48	24	12	6	110	110	48	24	12	6	-	-	-	-	-	-	110	24	12		
Auxiliaries																							
Extension																							
iETL		■	■	■	■	■	■	■	■	■	■	■	■	■	■	■	■	■	■	■	■		
Centralised control + indication																							
iATLc+s		■	■	■	■	-	■	■	■	■	-	-	-	-	-	-	-	■	■	■	■		
Centralised control																							
iATLc		■	■	■	■	-	■	■	■	■	-	-	-	-	-	-	-	■	■	■	■		
Indication																							
iATLs		■	■	■	■	-	■	■	■	■	■	■	■	■	■	■	■	■	■	■	■		
Multi-level centralised control																							
iATLc+c		■	■	■	■	-	■	■	■	■	-	-	-	-	-	-	-	■	■	■	■		
Latched control																							
iATLm		■	■	■	■	■	■	■	■	■	■	■	■	■	-	-	-	■	■	■	■		
Control for illuminated Pushbutton																							
iATLz		■	■	-	-	-	■	■	■	■	-	-	-	■	■	-	-	■	■	-	-		
Step by step control																							
iATL4		■	-	-	-	-	■	■	-	-	-	-	-	■	-	-	-	■	-	-	-		
Time delay control																							
iATEt		■	■	■	(*)	■	-	■	■	■	■	■	■	(*)	-	■	■	■	-	■	■	■	(*)
Control and indication																							
iATL24		■	-	-	-	-	■	■	-	-	-	-	-	■	-	-	-	■	-	-	-		

(*) iATEt : does not operate on 12 V DC.

Catalogue numbers

iTL impulse relays					
Type	1P		2P	3P	4P
Rating (In)	Control voltage (Uc)				
	(V AC)	(V DC)			
	(50/60 Hz)				
16 A	12	6	A9C30011	A9C30012	A9C30011 + A9C32016
	24	12	A9C30111	A9C30112	A9C30111 + A9C32116
	48	24	A9C30211	A9C30212	A9C30211 + A9C32216
	130	48	A9C30311	A9C30312	A9C30311 + A9C32316
	230...240	110	A9C30811	A9C30812	A9C30811 + A9C32816
32 A	230...240	110	A9C30831	A9C30831 + A9C32836	A9C30831 + 2 x A9C32836
Width in 9 mm modules			2	2	4

iTLI impulse relays				
Type	2P			
Rating (In)	Control voltage (Uc)			
	(V AC)	(V DC)		
	(50/60 Hz)			
16 A	12	6	A9C30015	
	24	12	A9C30115	
	48	24	A9C30215	
	130	48	A9C30315	
	230...240	110	A9C30815	
Width in 9 mm modules			2	

7

iETL extensions for iTL and iTLI						
Type	Rating (In)			Control voltage (Uc)		Width in 9 mm modules
	(V AC)	(V DC)	(V AC)	(V DC)		
	(50/60 Hz)		(50/60 Hz)			
	32 A	230...240	110	A9C32836	2	
	16 A	12	6	A9C32016	2	
		24	12	A9C32116	2	
		48	24	A9C32216	2	
		130	48	A9C32316	2	
		230...240	110	A9C32816	2	

Catalogue numbers (cont.)

iTLc impulse relay with centralised control			
Type	1P	3P	
Rating (In)	Control voltage (Uc) (V AC) (50/60 Hz)		
16 A	24	A9C33111	A9C33111 + A9C32116
	48	A9C33211	A9C33211 + A9C32216
	230...240	A9C33811	A9C33811 + A9C32816
Width in 9 mm modules		2	4





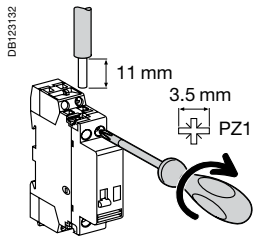

iTLm impulse relay with latched control			
Type	1P	3P	
Rating (In)	Control voltage (Uc) (V AC) (50/60 Hz)		
16 A	230...240	A9C34811	A9C34811 + A9C32816
Width in 9 mm modules		2	4

iTLs impulse relay with remote indication*			
Type	1P	3P	
Rating (In)	Control voltage (Uc) (V AC) (50/60 Hz) (V DC)		
16 A	24 12	A9C32111	A9C32111 + A9C32116
	48 24	A9C32211	A9C32211 + A9C32216
	230...240 110	A9C32811	A9C32811 + A9C32816
Width in 9 mm modules		2	4



(* Short circuit protection device for indication contacts : 6 A gG fuse.

Connection



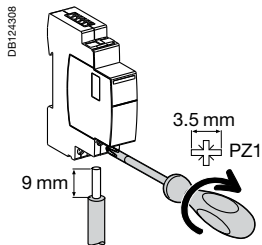

Type	Rating	Circuit	Tightening torque	Copper cables	
				Rigid or ferrule	Flexible or ferrule
iTL, iTLi, iTLc, iTLm, iTLs, iETL	16 A	Control	1 N.m		
		Power			
iTL, iETL	32 A	Control	1.2 N.m		
		Power			
iATLs, iATLc, iATLc+s, iATLc+c, iATLm, iATeT, iATL4, iATLz			1 N.m		

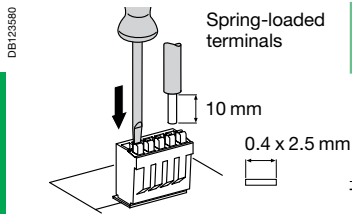

Type	Terminals	Tightening torque	Copper cables		
			Rigid	Flexible	Flexible or ferrule
iATL24	Power supply (N/P) Input (Y1/Y2)	1 N.m	 0.5 to 10 mm ² 2 x 0.5 to 2 x 2.5 mm ²	 0.5 to 6 mm ² 2 x 0.5 to 2 x 2.5 mm ²	 0.5 to 4 mm ² 2 x 0.5 to 2 x 2.5 mm ²

Ti24 connector connection



Type	Catalogue numbers	Copper cables	
		Rigid	Flexible
Ti24 interface	A9XC2412	 1 x 0.5 to 1.5 mm ²	 1 x 0.5 to 1.5 mm ²

Ti24 prefabricated cables connection

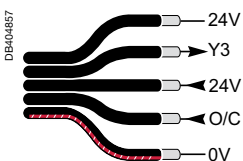

Type	Catalogue numbers	Length
Connection for Acti 9 Smartlink		
6 short prefabricated	A9XCAS06	100 mm
6 medium-sized prefabricated	A9XCAM06	160 mm
6 long prefabricated	A9XCAL06	870 mm
Connection for PLC type terminals		
6 long prefabricated on a single side	A9XCAU06	870 mm

Operation

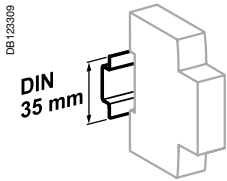
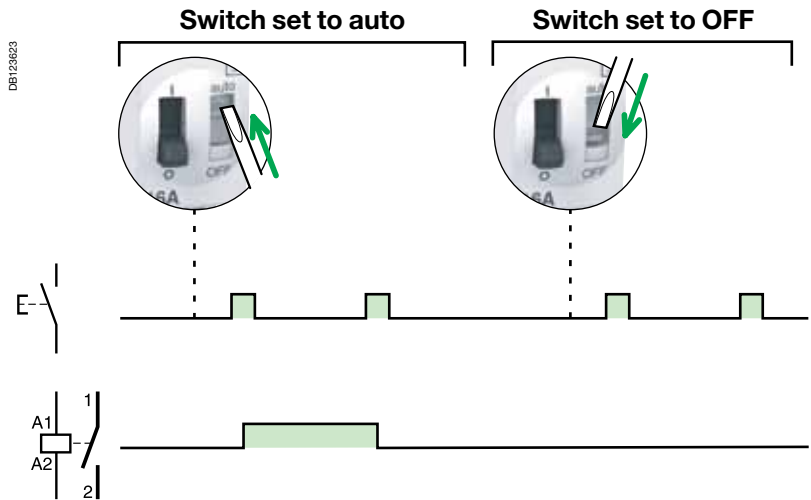

Clip on DIN rail 35 mm.

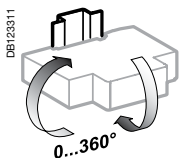



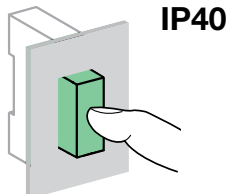
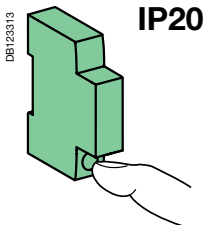





Indifferent position of installation.

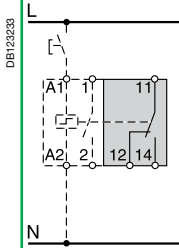
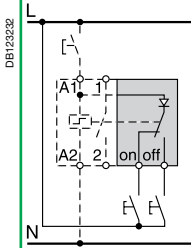
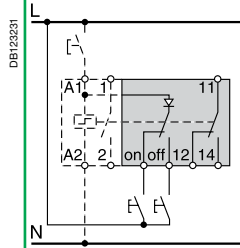
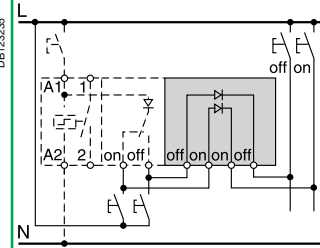

Technical data

Control circuit		
	iTL and iTLI 16 A iTLc, iTLm, iTLs, iETL 16 A	iTL 32 A, iETL 32 A
Dissipated power (during the impulse)	1, 2, 3P: 19 VA 4P: 38 VA	19 VA
Illuminated PB control	Max. current 3 mA (if > use an ATLz)	
Operating threshold	Min. 85 % of Un in conformance with IEC/EN60669-2-2	
Duration of the control order	50 ms to 1 s (200 ms recommended)	
Response time	50 ms	
Power circuit		
Voltage rating (Ue)	1P, 2P	24 ...250 V AC
	3P, 4P	24...415 V AC
Frequency	50 Hz or 60 Hz	
Maximum number of operations per minute	5	
Maximum number of switching operation a day	100	
Additional characteristics to IEC/EN 60947-3		
Insulation voltage (Ui)	440 V AC	
Pollution degree	3	
Rated impulse withstand voltage (Uimp)	6 kV	
Endurance (O-C)		
Electrical to IEC/EN 60947-3	200,000 cycles (AC21)	50,000 cycles (AC21)
	100,000 cycles (AC22)	20,000 cycles (AC22)
Overvoltage category	IV	
Other characteristics		
Degree of protection (IEC 60529)	Device only	IP20
	Device in modular enclosure	IP40 Insulation class II
Operating temperature	-20°C to +50°C	
Storage temperature	-40°C to +70°C	
Tropicalization (IEC 60068-1)	Treatment 2 (relative humidity 95 % at 55°C)	

		Indication	Control		
Auxiliaries		iATLs	iATLc	iATLc+s	iATLc+c
Type		Indication	Centralised control	Centralised control + indication	Multi-level centralised control
					
		PB106139-34	PB106137-34	PB106140-34	PB106136-34
Function					
		<ul style="list-style-type: none"> Allows remote indication of the associated impulse relay 	<ul style="list-style-type: none"> Used for centralised control, thanks to a "pilot line", of a group of impulse relays controlling separate networks, while at the same time maintaining local individual control of each impulse relay 	<ul style="list-style-type: none"> And for remote indication of the mechanical status of each relay 	<ul style="list-style-type: none"> Used to control the centralised controls of a number of impulse relay groups, while at the same time maintaining local individual control and centralised control by level
Wiring diagrams					
					
		DB123233	DB123232	DB123231	DB123235
		-	-	-	<ul style="list-style-type: none"> Each group, made up of iTLc or (iTL or iTLI or iTLs) + iATLc+s, must only contain a single iATLc+c Maximum number of impulse relays that can be controlled: <ul style="list-style-type: none"> 230 V AC: 24 130 V AC: 12 48 V AC: 5
Mounting					
		<ul style="list-style-type: none"> Mounted to the right of iTL by yellow clips 	<ul style="list-style-type: none"> Mounted to the right of iTL by yellow clips 	<ul style="list-style-type: none"> Mounted to the right of iTL by yellow clips 	<ul style="list-style-type: none"> Without mechanical link with impulse relays and auxiliaries
Catalogue numbers		A9C15405	A9C15404	A9C15409	A9C15410
Technical specifications					
Control voltage (Ue)	V AC	24...240	24...240	24...240	24...240
	V DC	24...240	-	-	-
Control voltage frequency	Hz	50/60	50/60	50/60	50/60
Width in 9 mm modules		1	1	2	2
Auxiliary contact (breaking capacity)		<ul style="list-style-type: none"> Minimum: 10 mA at 24 V AC/DC Maximum (IEC 60947-5-1): <ul style="list-style-type: none"> 12...240 V AC 6 A 12...24 V DC 6 A 15...240 V AC 2 A 13...24 V DC 2 A 	-	<ul style="list-style-type: none"> Minimum: 10 mA at 24 V AC/DC Maximum (IEC 60947-5-1): <ul style="list-style-type: none"> 12...240 V AC 6 A 12...24 V DC 6 A 15...240 V AC 2 A 13...24 V DC 2 A 	-
Number of contacts		-	-	-	-
Operating temperature	°C	-20°C to +50°C	-	-	-
	°C	-40°C to +70°C	-	-	-

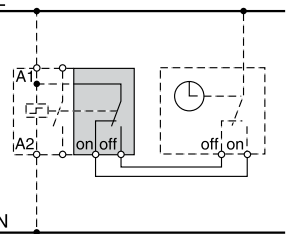
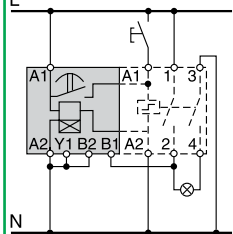
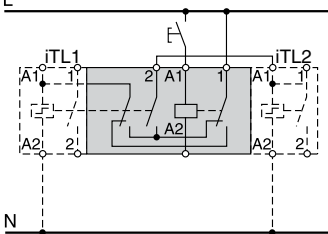
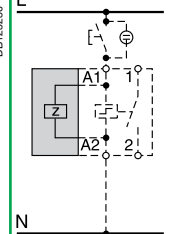
iATLm	iATEt	iATL4	iATLz
Latched control	Time delay	Step by step control	Control by illuminated push-buttons
			
<ul style="list-style-type: none"> Combined with an impulse relay, it operates on latched orders 	<ul style="list-style-type: none"> Combined with an impulse relay, it automatically disconnects the circuit after a preset time 	<ul style="list-style-type: none"> Allows the step by step sequence over 2 circuits 	<ul style="list-style-type: none"> Used to control impulse relays by illuminated push-buttons, without operating risks
			
-	<ul style="list-style-type: none"> 5 time setting ranges: <ul style="list-style-type: none"> 1 to 10 s 6 to 60 s 2 to 10 min 6 to 60 min 2 to 10 h 	<ul style="list-style-type: none"> The cycle is as follows: <ul style="list-style-type: none"> 1st impulse - iTL 1 closed, iTL 2 open 2nd impulse - iTL 1 open, iTL 2 closed 3rd impulse - iTL 1 and 2 closed 4th impulse - iTL 1 and 2 open 5th impulse - iTL 1 closed, iTL 2 open, etc 	<ul style="list-style-type: none"> Provide an iATLz when the current drawn up by the illuminated push-buttons is higher than 3 mA (this current is sufficient to keep the coils energised). Above this value, fit one extra iATLz per 3 mA. For example: for 7 mA, fit 2 iATLz
<ul style="list-style-type: none"> Mounted to the right of iTL by yellow clips 	<ul style="list-style-type: none"> Mounted to the left of iTL by yellow clips 	<ul style="list-style-type: none"> Assembled between 2 impulse relays: according to the auxiliarisation table by yellow clips 	<ul style="list-style-type: none"> Mounted to the left of iTL by yellow clips
A9C15414	A9C15419	A9C15412	A9C15413
12...240	24...240	230	130...240
6...110	24...110	-	-
50/60	50/60	50/60	50/60
1	2	4	2
-	-	-	-
-	-	-	-
-20°C to +50°C	-	-	-
-40°C to +70°C	-	-	-

Control and indication

Auxiliaire	iATL24
Type	Control and indication 24 V DC

With Ti24 connector



Function	<ul style="list-style-type: none"> ■ This auxiliary allows a impulse relay to be interfaced with the Acti 9 Smartlink interface or a programmable logic controller (PLC) in 24 V DC (control, O/C indication) ■ 230 V AC control
-----------------	--

Wiring diagrams	<p>Wiring with exclusive selector 230 V AC and 24 V DC controls</p>	<p>Wiring for non-exclusive 230 V AC and 24 V DC controls</p>
------------------------	---	---

Mounting	<ul style="list-style-type: none"> ■ To the left of the iTL impulse relay using the yellow clips⁽¹⁾. ■ When an iATL24 is used, the A1/A2 terminals of the impulse relay should not be wired. Only the yellow clips integral with the iATL24 should be used for connection to the coil.
-----------------	---

Utilization	<ul style="list-style-type: none"> ■ 230 V AC interface: <ul style="list-style-type: none"> □ Y1: enabling of 24 V DC control (Y1 = 1) or inhibition of 24 V DC control (Y1 = 0). □ Y2: 230 V pulse control ■ "Ti24" 24 V DC interface: <ul style="list-style-type: none"> □ Y3: 24 V DC control of iTL closing on rising edge and opening on falling edge □ reading of the impulse relay status (opened or closed) from the position of the integrated O/C auxiliary contact □ monitoring of connection of the "Ti24" terminal block by the upstream system (PLC, supervision system) via the 24 V terminal (in the centre of the Ti24 terminal block)
--------------------	--

Catalogue numbers	A9C15424
--------------------------	-----------------

Technical specifications	
Control voltage (Ue)	V AC 230, +10 %, -15 % (Y2) V DC 24, ± 20 % (Y3)
Control voltage frequency	Hz 50/60
Insulation voltage (Ui)	V AC 250
Rated impulse withstand voltage (Uimp)	kV 8 (OVC IV)
Pollution degree	3
Degree of protection	IP20B device only IP40 device in modular enclosure
Width in 9 mm modules	2
Auxiliary contact (O/C) Ti24	24 V DC protected output, min. 2 mA, max. 100 mA
Contact	1 O/C operating category AC 14
Operating temperature	°C -25°C to +60°C
Storage temperature	°C -40°C to +80°C
Consumption	<1 W
Standard	IEC/EN 60947-5-1

(1) Mechanical and electrical connection.



Operation of the iATL24

O/C 24 V DC output

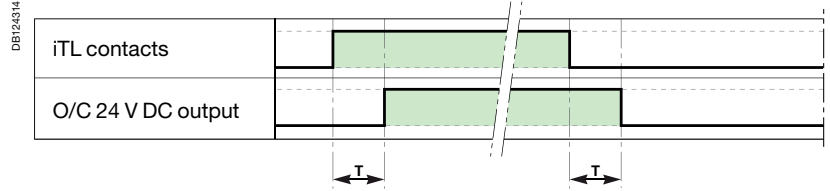

Parameter	Min	Max
T	100 ms	200 ms

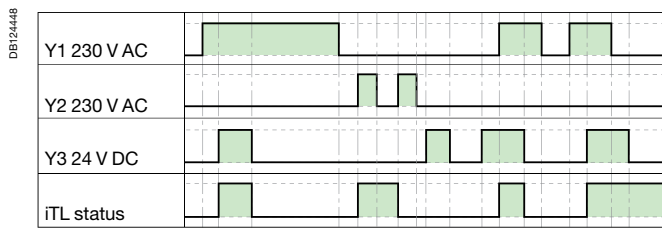
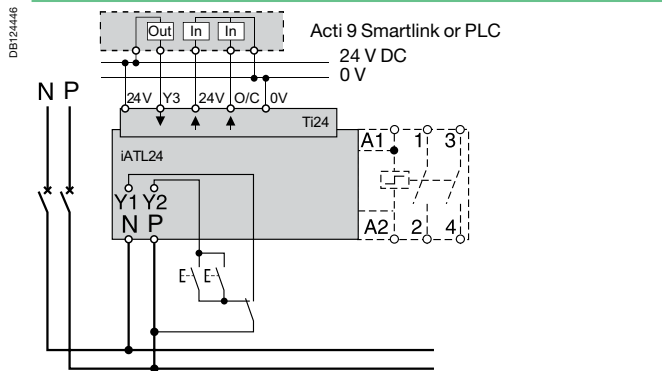

- Minimum duration of 230 V AC pulse (Y2): 200 ms.
- 30 iATL24 closing or opening actuations are authorized per minute: Minimum time delay between 2 actuations on the iATL24 via Y1, Y2, Y3 (closing or opening of the iTL coil): 440 ms.
- 10 closing or opening actuations spaced 440 milliseconds apart are authorized following no loading of the iATL24 during a period of 20 seconds.

Wiring with exclusive selector 230 V AC and 24 V DC controls

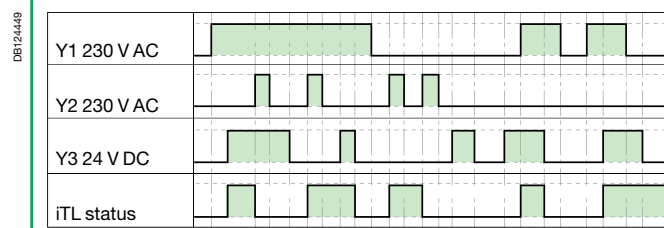
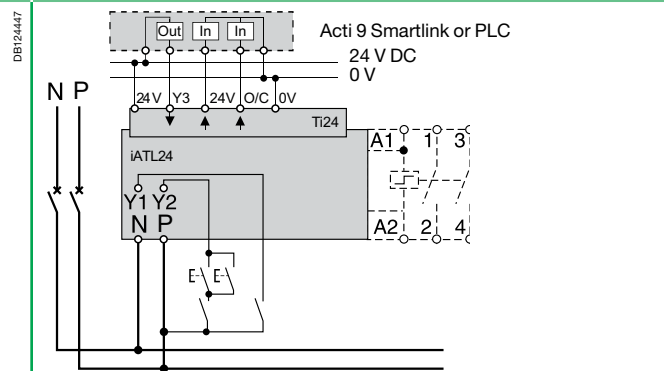

Wiring for non-exclusive 230 V AC and 24 V DC controls



Security		
Accessories	Yellow clips	Spacer
	 <p>PB106143-10</p>	 <p>PB104483</p>
Function	<ul style="list-style-type: none"> Ensure the mechanical and/or electrical link between impulse relays and their auxiliaries (set of 10). 	<ul style="list-style-type: none"> Required to reduce temperature rise of modular devices installed side by side. Recommended to separate electronic devices (thermostat, programmable clock, etc.) from electromechanical devices (relays, contactors).
Catalogue numbers	A9C15415	A9A27062
Technical specifications		
Width in 9 mm modules	-	1

Dimensions (mm)

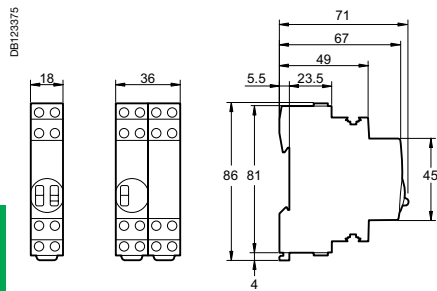

DB123375
iTL 1P
iTLc
iTLm
iTLs
iTLi
iETL

iTL+iETL
iTL 4P

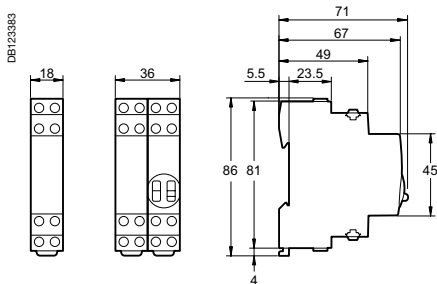

DB123383
iATLc+s
iATLc+c
iATLz
iATL4

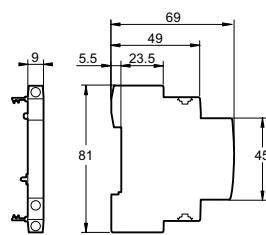

iATLc
iATLs
iATLm

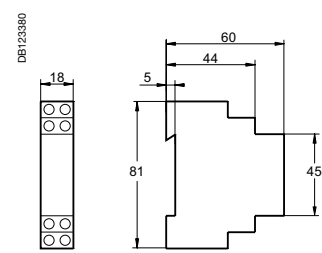

iATEt

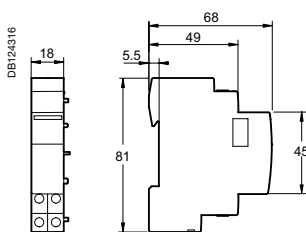

DB124316
iATL24

EN 60669-2-2

The iTL+ high-performance impulse relay allows remote control of single-phase circuits. It is designed for demanding applications.

The iTL+ high-performance impulse relay is used for push-button control of lighting circuits consisting of:

- incandescent lamps, low-voltage halogen lamps, etc. (resistive loads)
- fluorescent tubes, discharge lamps, etc. (inductive loads).

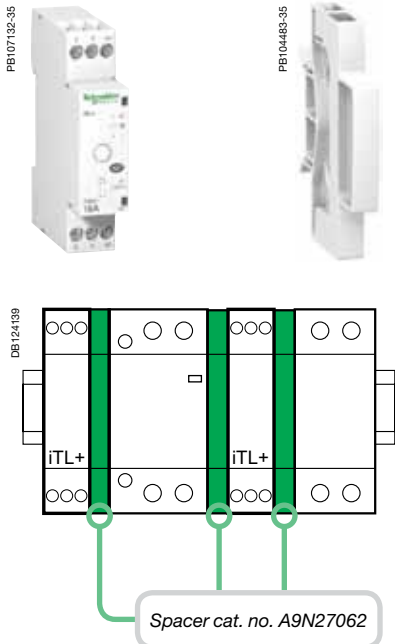

iTL+			
Type	Rating		Width in 9 mm modules
1P+N			
	16 A	A9C15032	2+1 ⁽¹⁾

(1) Supplied with a 9 mm spacer (cat. no. A9N27062): to be used for mounting the iTL+ alongside a circuit breaker, contactor, impulse relay, etc., in order to maintain optimal operation.



It is compulsory:

- to connect the neutral
- to keep the same control circuit connection "A1: phase", "A2: neutral"
- to use the same phase for connection of the power and control functions.

Operation

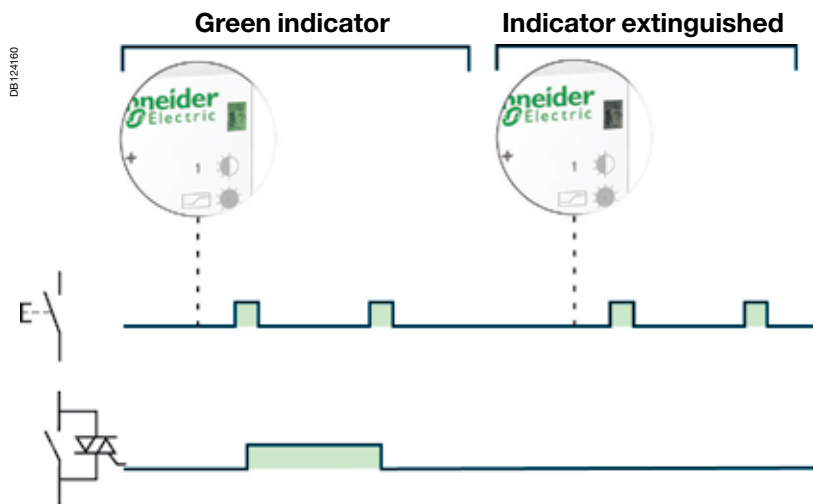
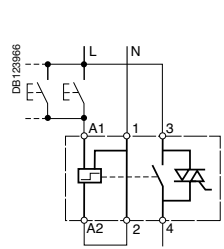

7

Connection

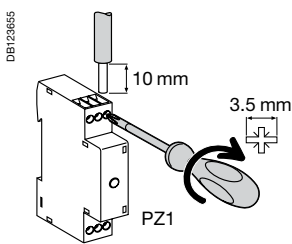

Type	Rating	Tightening torque	Copper cables	
			Rigid or flexible with ferrule	Rigid or flexible without ferrule
iTL+	16 A	1 N.m		

They combine the benefits of static switching and electromechanical technology: small size, little temperature rise.

- Silent
- Large number of switching operations
- Green indicator on the front panel:
 - fixed green: ON/OFF control by push button
 - flashing green: forced starting
 - extinguished: forced stoppage
- Operating mode selection push button:
 - ON/OFF control by push button
 - forced starting
 - forced stoppage
- Orange indicator: output contact closed
- Equivalent performances with all types of lamps

Following a mains failure, the iTL+ returns to 0 position (forced stoppage) irrespective of its initial state.

7

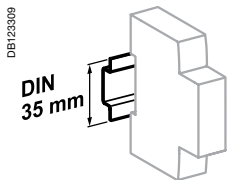

Clip on DIN rail 35 mm.

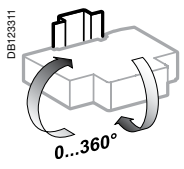

Indifferent position of installation.

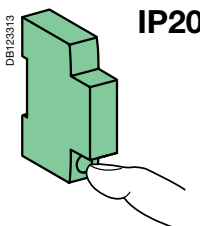

IP20

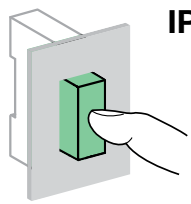

IP40

Technical data

Control circuit		
Coil voltage (Uc)		230 V AC
Frequency		50 Hz
Inrush power		11 VA
Holding power		1.1 VA
Control by luminous push button		Max. current 5 mA
Control order duration		50 ms to 1 s (recommended 200 ms)
Power circuit		
Voltage rating (Ue)		230 V AC
Frequency		50 Hz
Electrical load	Minimum	20 W
	Maximum	3600 W
Max. number of switching operations per minute		6
Other characteristics		
Degree of protection (IEC 60529)	Device only	IP20
	Device in modular enclosure	IP40 Insulation class II
Endurance (O-C)	Electrical	5.000.000 cycles (AC21 - AC22)
Noise level at activation		< 30 dBA
Operating temperature		-5°C to +55°C
Storage temperature		-40°C to +60°C
Tropicalization (IEC 60068-1)		Treatment 2 (relative humidity of 95 % at 55°C)





Weight (g)

High-performance impulse relays	
Type	iTL+
1P+N	70



IEC 60947-5-1

■ iLL indicator lights light up to indicate that a voltage is present.

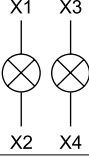
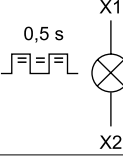
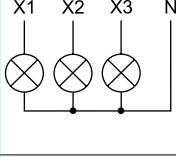
Catalogue numbers

iLL indicator lights										
Type	Single					Double		Flashing light	Three-phase voltage presence indicator light	
										
Diagram										
Colour	Red	Green	White	Blue	Yellow	Green/red	White/white	Red	Red/red/red	
Cat. no.										
12...48 V AC/DC	A9E18330	A9E18331	A9E18332	A9E18333	A9E18334	A9E18335	-	-	-	
110...230 V AC	A9E18320	A9E18321	A9E18322	A9E18323	A9E18324	A9E18325	A9E18328	A9E18326	-	
230...400 V AC (3 phases)	-	-	-	-	-	-	-	-	A9E18327	
Width in 9 mm modules	2					2		2	2	

Connection

Tightening torque	Copper cables	
	Rigid	Flexible or ferrule
1 N.m	 0.5 mm ² min. 2 x 2.5 mm ² max.	 0.5 mm ² min. 2 x 2.5 mm ² max.

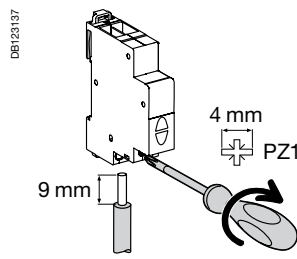

- Phase-separated wall that can be divided to allow the teeth of all types of comb busbar to pass through.
- Staggered terminals to simplify connection.

Dimensions (mm)

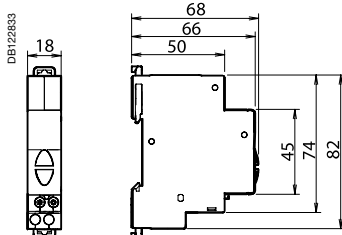

Technical data

Main characteristics	
Pollution degree	3
Power circuit	
Operating frequency	50...60 Hz
Flashing frequency	2 Hz
Additional characteristics	
Operating temperature	-35°C... +70°C
Storage temperature	-40°C... +80°C
Tropicalization	Treatment 2 (relative humidity 95 % at 55°C)
LED indicator light	Consumption per indicator light: 0.3 W
	Service life: 100,000 hours of constant lighting efficiency
	Maintenance-free indicator light (non-interchangeable LEDs)

IEC 60669-1 and IEC 60947-5-1

■ iPB pushbuttons are used to control electric circuits by means of pulses.

Catalogue numbers

iPB pushbuttons																		
Type	Single				Double		Single + indicator light											
Diagram	1 NC 3 E-7 4		1 NO 1 E-7 2		1 NO + 1 NC 1 3 E-7 2 4		1 NO / 1 NC 1 3 E-7 E-7 2 4		1 NO / 1 NO 1 3 E-7 E-7 2 4		1 NO 1 X1 E-7 2 X2		1 NC 3 X1 E-7 4 X2		1 NO 1 X1- E-7 2 X2+		1 NC 3 X1- E-7 4 X2+	
Pushbutton Colour	Grey	Red	Grey	Grey	Green/red	Grey/grey	Grey	Grey	Grey	Grey	Grey	Grey	Grey	Grey	Grey	Grey		
Indicator light	Power supply	-	-	-	-	-	110...230 V AC		12...48 V AC/DC									
	Colour	-	-	-	-	-	Green	Red	Green	Red	Green	Red	Green	Red	Green	Red		
Cat. no.	A9E18030	A9E18031	A9E18032	A9E18033	A9E18034	A9E18035	A9E18036	A9E18037	A9E18038	A9E18039	A9E18038	A9E18039	A9E18038	A9E18039	A9E18038	A9E18039		
Width in 9 mm modules	2				2		2											

7

Connection

Tightening torque	Copper cables	
	Rigid	Flexible or ferrule
DB122945 1 N.m	DB122946 	
	0.5 mm ² min. 2 x 2.5 mm ² max.	0.5 mm ² min. 2 x 2.5 mm ² max.

- Phase-separated wall that can be divided to allow the teeth of all types of comb busbar to pass through.
- Staggered terminals to simplify connection.

Dimensions (mm)

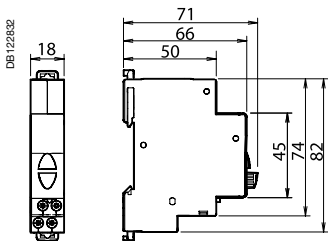

Technical data

Main characteristics	
Pollution degree	3
Power circuit	
Voltage rating (Ue)	250 V AC
Current rating (Ie)	20 A
Additional characteristics	
Endurance (O-C)	30,000 operations AC22 (cos φ = 0.8)
Operating temperature	-35°C... +70°C
Storage temperature	-40°C... +80°C
Tropicalization	Treatment 2 (relative humidity 95 % at 55°C)
LED indicator light	Consumption: 0.3 W Service life: 100,000 hours of constant lighting efficiency Maintenance-free indicator light (non-interchangeable LEDs)



RCM

IEC/EN 60947-3
BSEN 60947-3
AS/NZS 60947-3

The switch-disconnectors combine the following functions:

- Control (opening and closing of circuits under load).

iOF auxiliary

- Mounted on the left, it indicates the "open" or "closed" position of the switch and has a normally open (NO) or normally closed (NC) contact.



Catalogue numbers

40 to 125 A iSW switch-disconnectors					
Type				Width in 9 mm modules	
1P					
DB118698 	Rating	Voltage (Ue)		2	
	1	40 A	240 V AC		A9S66140
	2	63 A	240 V AC		A9S66163
		100 A	240 V AC		A9S66191
	125 A	240 V AC	A9S66192		
2P					
DB118989 	Rating	Voltage (Ue)		4	
	1 3	40 A	415 V AC		A9S66240
	2 4	63 A	415 V AC		A9S66263
		100 A	415 V AC		A9S66291
	125 A	415 V AC	A9S66292		
3P					
DB119000 	Rating	Voltage (Ue)		6	
	1 3 5	40 A	415 V AC		A9S66340
	2 4 6	63 A	415 V AC		A9S66363
		100 A	415 V AC		A9S66391
	125 A	415 V AC	A9S66392		
4P					
DB119001 	Rating	Voltage (Ue)		8	
	1 3 5 7	40 A	415 V AC		A9S66440
	2 4 6 8	63 A	415 V AC		A9S66463
		100 A	415 V AC		A9S66491
	125 A	415 V AC	A9S66492		
Operating frequency		50/60 Hz			
Accessories		Module CA907000 and CA907001			



Auxiliary			
Type			Width in 9 mm modules
DB118810 	Voltage (Ue)		1
	240...415 V AC		
		A9A26924	
		24...130 V DC	

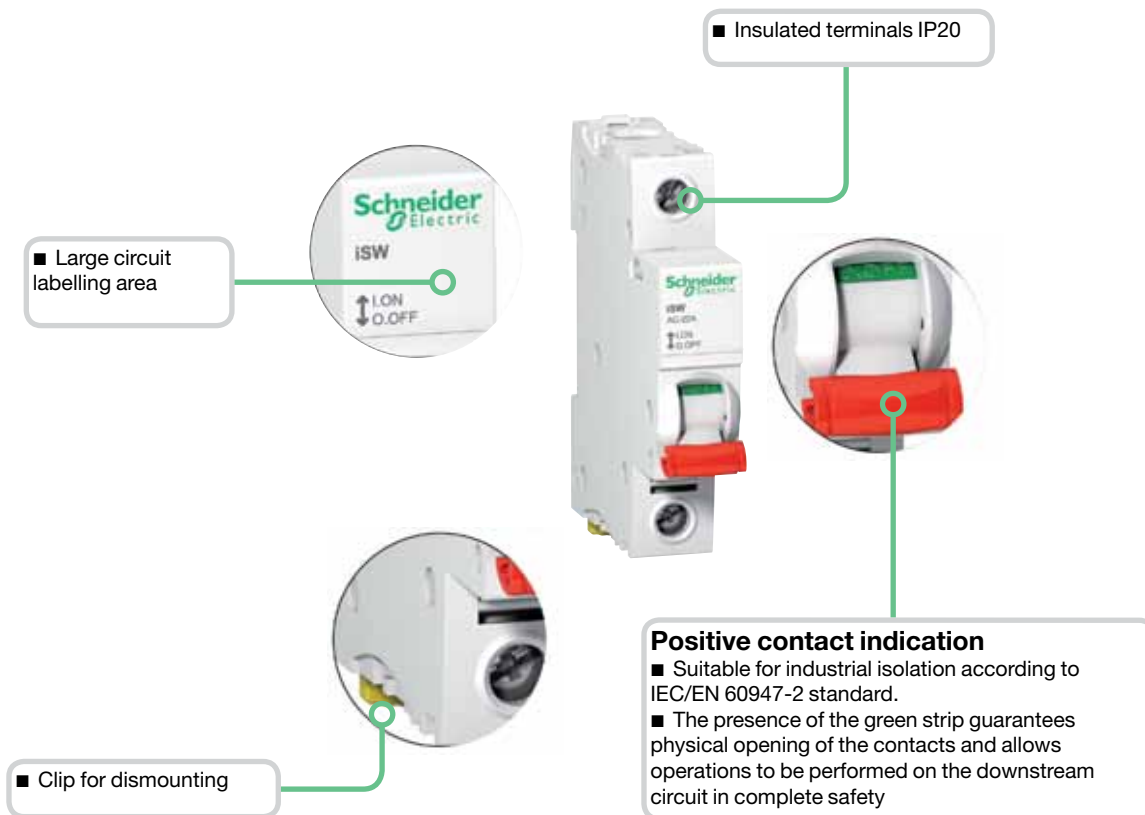

7

Dimensions (mm)

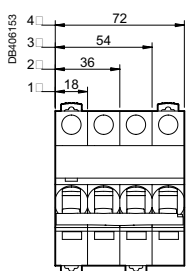

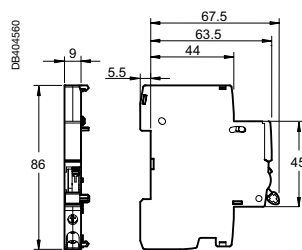
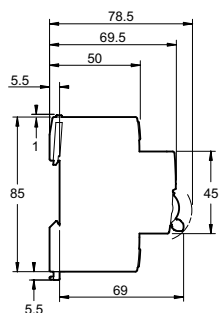

iSW





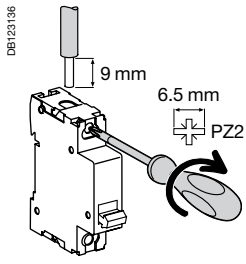

IOF

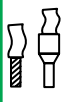
Connection

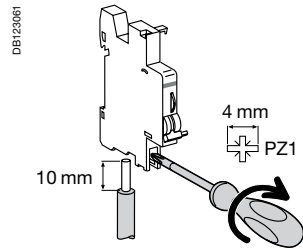

Type	Rating	Tightening torque	Copper cables	
			Rigid	Flexible or with ferrule
iSW	40 to 125 A	3.5 N.m	 ≤ 50 mm ²	 ≤ 35 mm ²



Type	Tightening torque	Copper cables		Multi-cables terminal	
		Rigid	Flexible	Rigid cables	Cables with ferrule
iOF	1 N.m	 1 to 4 mm ²	 0.5 to 2.5 mm ²	 2 x 2.5 mm ²	 2 x 1.5 mm ²

Technical data

Main characteristics

Insulation voltage (Ui)	1P: 250 V AC 2P, 3P, 4P: 500 V AC
Pollution degree	3
Power circuit	
Rated impulse withstand voltage (Uimp)	6 kV
Operating category	AC - 22 A
Permissible rated short-time withstand current (Icw)	1500 A
Conditional rated short-circuit current (Inc)	10 kA according to IEC 60947-3
Rated short-circuit closing current (Icm)	5 kA

Additional characteristics

Degree of protection	Device only	IP20	
	Device in modular enclosure	IP40	
Endurance (O-C)	Mechanical	20,000 cycles	
		40 A - 63 A	15,000 cycles
		80 A - 100 A	10,000 cycles
		125 A	2 500 cycles
Operating temperature	-25°C to +60°C		
Storage temperature	-40°C to +85°C		
Tropicalization	Treatment 2 (relative humidity 95% at 55°C)		

iOF characteristics

Rated voltage (Ue)	240...415 V AC	
	24...130 V DC	
Operating frequency	50/60 Hz	
Operating current	24 V DC	6 A
	48 V DC	2 A
	60 V DC	1.5 A
	130 V DC	1 A
	240 V AC	6 A
	415 V AC	3 A
	Number of contacts	1 NO/NC
Operating temperature	-35°C to +70°C	
Storage temperature	-40°C to +85°C	

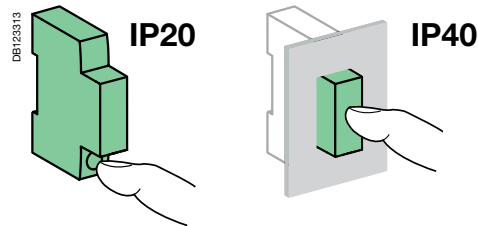

Position contact indication

- Suitable for industrial isolation according to IEC/EN 60947-3 standard.
- The presence of the green strip guarantees physical opening of the contacts and allows operations to be performed on the downstream circuit in complete safety.



PB 105286-40

DB122918



PB 105284-40



PB 105285-40

Control switches

iSW control switches (20, 32 A)

IEC/EN 60669-1, iSW switch with indicator light. IEC/EN 60669-2-4, iSW switch without indicator light.

These switches are used for:

- Control (opening and closing of circuits under load).
- The 1P and 2P switches are available with or without indicator light.
- Disconnection, for switches without indicator light IEC/EN 60669-2-4.

iSW switch-disconnectors (40 to 125 A)

IEC 60947-3

The switch-disconnectors combine the following functions:

- Control (opening and closing of circuits under load).

OF iSW auxiliary

- Mounted on the left, it indicates the "open" or "closed" position of the switch and has a normally open (NO) or normally closed (NC) contact.

Catalogue numbers

20, 32 A iSW control switches				
Type	Rating	Voltage (Ue)		Width in 9 mm modules
 DB118898	20 A	250 V AC	A9S60120	2
	32 A	250 V AC	A9S60132	
 DB118899	20 A	250 V AC	-	2
		415 V AC	A9S60220	
	32 A	250 V AC	-	
		415 V AC	A9S60232	
 DB119000	20 A	415 V AC	A9S60320	4
	32 A	415 V AC	A9S60332	
 DB119001	20 A	415 V AC	A9S60420	4
	32 A	415 V AC	A9S60432	
Operating frequency			50/60 Hz	
Accessories			Module CA907012	



Control switches with indicator light

Catalogue numbers (cont.)

20, 32 A iSW control switches with indicator light			
Type	Rating	230 V indicator light	Width in 9 mm modules
1P 	20 A	A9S61120	2
	32 A	A9S61132	
2P 	20 A	A9S61220	2
	32 A	A9S61232	
Operating frequency		50/60 Hz	
Accessories		Module CA907012	

Spare indicator lights for 20, 32 A iSW switches		
Type	Voltage (Ue)	
Neon		
Supplied with a red diffuser (Pack of 10)	230 V AC	15111
Incandescent bulb (P=1.2 W)		
Supplied with a red diffuser (Pack of 10)	12 V DC/AC	15112
	24 V DC/AC	15113
	48 V DC/AC	15114



OF iSW

Catalogue numbers (cont.)

Auxiliary				Width in 9 mm modules
Type				
OF iSW	Rating	Voltage (Ue)	A9A15096	2
	3 A	415 V AC		
	6 A	250 V AC		

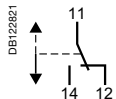

Technical data

Main characteristics		20, 32 A iSW	
Insulation voltage (Ui)		Without indicator light ■ 1P: 250 V AC ■ 2P, 3P, 4P: 500 V AC	With indicator light 250 V AC
Pollution degree		2	
Power circuit			
Rated impulse withstand voltage (Uimp)		4 kV	
Operating category		AC - 22 A	
Permissible rated short-time withstand current (Icw)		-	
Conditional rated short-circuit current (Isc)		3 kA to IEC/EN 60669-2-4	
Rated short-circuit closing current (Icm)		-	
Using direct current		48 V (110 V with 2 poles in series)	
Additional characteristics			
Degree of protection		IP40 on the front panel	
Endurance (O-C)	Mechanical	300,000 cycles	
	Electrical	30,000 cycles	
Operating temperature		-20°C to +50°C	
Storage temperature		-40°C to +70°C	
Tropicalization		Treatment 2 (relative humidity 95% at 55°C)	

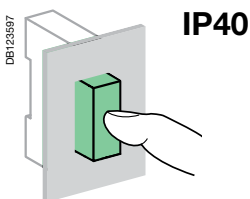

Connection

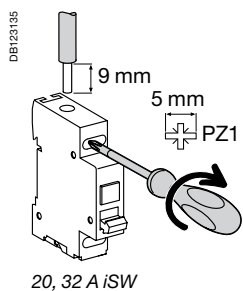

Type	Rating	Tightening torque	Copper cables	
			Rigid	Flexible or ferrule
iSW	20, 32 A	1.2 N.m	10 mm ²	10 mm ²
OF iSW	-	1.2 N.m	10 mm ²	10 mm ²

Dimensions (mm)

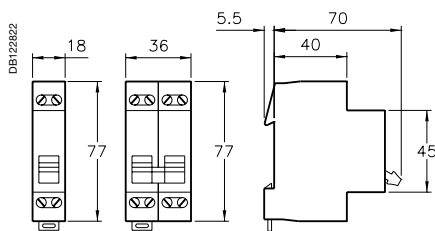

1P, 2P 3P, 4P
20, 32 A iSW

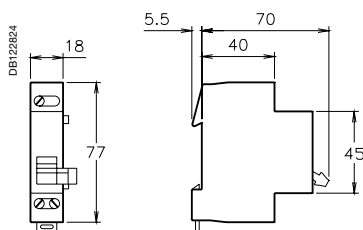



OF iSW

IEC 60669-1 and IEC 60947-5-1

■ iSSW linear switches are used for the manual control of electric circuits.

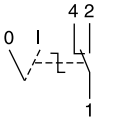
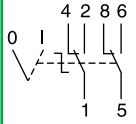
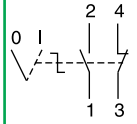
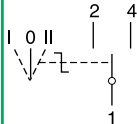
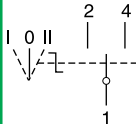

Catalogue numbers

iSSW linear switches					
Type	2 positions			3 positions	
					
Contact	1 changeover switch	2 changeover switches	1 NO + 1 NC	1 changeover switch	2 changeover switches
Diagram					
Cat. no.	A9E18070	A9E18071	A9E18072	A9E18073	A9E18074
Width in 9 mm modules	2	4	2	2	4

7

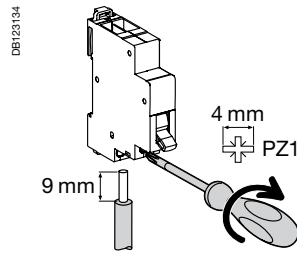
Connection



Tightening torque	Copper cables	
	Rigid	Flexible or ferrule
1 N.m	 0.5 mm ² min. 2 x 2.5 mm ² max.	 0.5 mm ² min. 2 x 2.5 mm ² max.

- Phase-separated wall that can be divided to allow the teeth of all types of comb busbar to pass through.
- Staggered terminals to simplify connection.

Dimensions (mm)

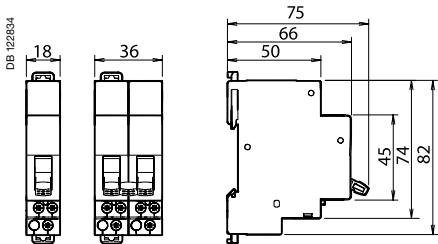

Technical data

Main characteristics	
Pollution degree	3
Power circuit	
Voltage rating (Ue)	250 V AC
Current rating (Ie)	20 A
Additional characteristics	
Endurance (O-C)	30,000 cycles AC22 (cos φ = 0.8)
Operating temperature	-20°C... +50°C
Storage temperature	-40°C... +70°C
Tropicalization	Treatment 2 (relative humidity 95 % at 55°C)



Bell transformers: NF EN 60742, EN/IEC 61558-2-8.
Safety transformers: NF EN 60742, EN/IEC 61558-2-6.

Bell transformers and safety transformers allow for a very low voltage (ELV 8 V, 12 V or 24 V) to be obtained from a low voltage network (LV 230 V).

- All Schneider Electric transformers are:
- safe: primary and secondary circuits are perfectly insulated by each other
 - resistant to short-circuit currents thanks to the built-in device.

Catalogue numbers

Bell transformer					
Type	Power	Secondary voltage		Width in 9 mm modules	
ESB769 	4 VA	8 V AC	A9A15214	4	
ESB760 	4 VA	8-12 V AC	A9A15213	4	
		8 VA	8-12 V AC	A9A15216	4
		16 VA	8-12 V AC	A9A15212	4
ESB761 	25 VA	12-24 V AC	A9A15215	6	

Safety transformer				
Type	Power	Secondary voltage		Width in 9 mm modules
DB124153 	16 VA	12-24 V AC	A9A15218	10
				25 VA
DB124154 	40 VA	12-24 V AC	A9A15220	10
				63 VA
DB124155 				
Operating frequency	50/60 Hz			

Terminal shield	
Type	Width in 9 mm modules
15228	4
15229	6

Connection

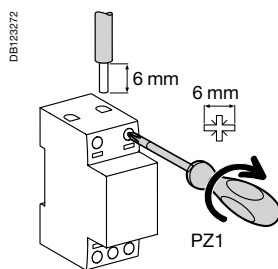

Tightening torque	Copper cables	
	Rigid	Flexible or with ferrule
0.5 N.m	< 2.5 mm ²	< 2.5 mm ²

Technical data

Main characteristics

Primary voltage	230 V AC ±10 %
Secondary voltage on load	For bell transformers: 8-12-24 V AC ±15 % For safety transformers: 12-24 V AC ±5 %

Transformer catalogue numbers	Rated secondary voltage	Off load voltage
A9A15214	8 V	12 V
A9A15213	8 V	12 V
	12 V	16 V
A9A15216	8 V	13 V
	12 V	18 V
A9A15212	8 V	13 V
	12 V	18 V
A9A15215	12 V	16 V
	24 V	32 V
A9A15218	12 V	14 V
	24 V	28 V
A9A15219	12 V	14 V
	24 V	28 V
A9A15220	12 V	14 V
	24 V	28 V
A9A15222	12 V	14 V
	24 V	28 V

Additional characteristics

Degree of protection (IEC 60529)	Device only	IP20 with terminal shield
Operating temperature		-20°C to +55°C
Storage temperature		-25°C to +80°C

Note: Transformers have an off load operating voltage that is higher than the rated voltage. For loads that are sensitive to overloads (electro-magnetic circuits), the transformer must be made to operate at I_n . After operation of the protection device upon an overload, cut-off the power supply and let the transformer cool down before restart.

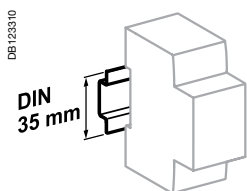

Clip on DIN rail 35 mm.

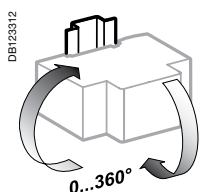

Bell transformer: indifferent position of installation.
Safety transformer: vertical position.

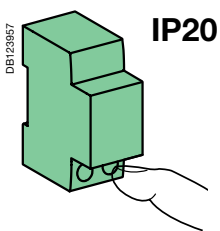

Weight (g)

iTR		
Type	Cat. no.	Weight
Bell	A9A15212	384
	A9A15213	240
	A9A15214	237
	A9A15215	633
	A9A15216	275
Safety	A9A15218	1082
	A9A15219	1125
	A9A15220	1190
	A9A15222	1309

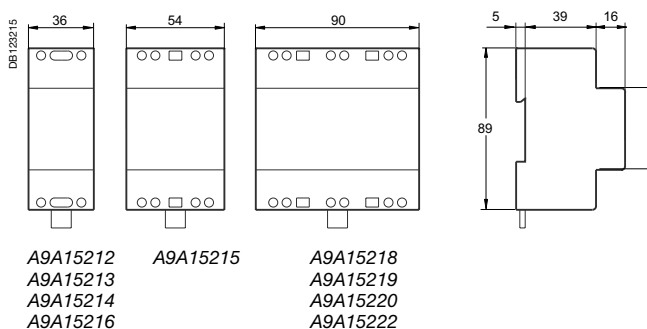

Dimensions (mm)



ISO and iRO

Audible indication in housing and the tertiary sector.

Catalogue numbers

Bell and buzzer			
Type	Width in 9 mm modules		
iSO bell	Voltage (Ue)		
DB123820 	230 V AC	A9A15320	2
	8...12 V AC	A9A15321	2
iRO buzzer			
DB123821 	230 V AC	A9A15322	2
	8...12 V AC	A9A15323	2
Operating frequency	50...60 Hz		



iSO



iRO

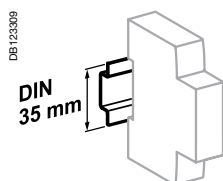

Connection

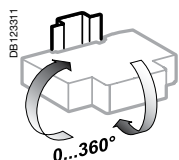

Clip on DIN rail 35 mm.

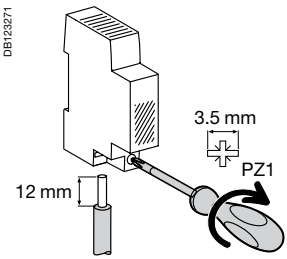

Indifferent position of installation.

DB123271 	Tightening torque	Copper cables	
		Rigid	Flexible or ferrule
	1.3 N.m	DB122945 	DB122946 
		< 4 mm ²	< 4 mm ²

Technical data

Main characteristics		iSO	iRO
Consumption	8...12 V AC	3.6 VA	
	220...240 V AC	5 VA	
Additional characteristics			
Degree of protection (IEC 60529)	Device only	IP40	
	Device in modular enclosure	IP20	
Operating temperature	-10°C to +40°C		
Storage temperature	-25°C to +60°C		
Sound level (at a distance of 60 cm)	80 dBA		70 dBA

Weight (g)

Bell and buzzer	
Type	
iSO	77
iRO	64

Dimensions (mm)

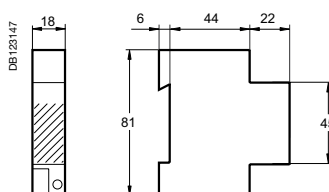

iSO bell and iRO buzzer



Function

STI

The isolatable fuse-carriers provide overload and short-circuit protection and are used in the tertiary and industrial sectors.

Fuse-links

aM, gG (gL, gL) types for STI.

Indicator light

230 V neon indicator adaptable on STI.

Description

STI

- Isolation of all poles is guaranteed for the 2P, 3P, and 3P + N versions during factory assembly
- Positive contact indication
- To be equipped with aM or gG (gL - gL) type fuse-links, with or without fuse blowing indicator

Rating (A)	Size (mm)	aM fuse	gG fuse
0.5 to 20	8.5 x 31.5		■
1 to 20	10.3 x 38	■	
25 to 32	10.3 x 38		■

- Fuse-carrier: Captive, additional housing is provided for a spare fuse
- Optional indication by indicator lights (see accessories)
- Connection by tunnel terminals for rigid cables up to 10 mm² and flexible cables up to 6 mm²
- Complies with standard IEC 947.3

Fuse-links

- aM, gG (gL - gL) types
- Fuse-link without striker pin
- Breaking capacity as in the standards

Dimensions (ø x L) (mm)	Rating (A)	Operating voltage (V AC)	Breaking capacity (kA)	
			aM	gG
8.5 x 31.5	All	380	20	20
10 x 38	<10	500	80	80
	25	660	80	80

- Complies with standards NF C 60 200 and NF C 63 210
- Véritas and Lloyds approved

Indicator light (option)

Technical data

230V AC neon (400V AC maximum)

Allows indication of fuse blowing (lift after blowing)

Specific characteristics

STI 1P + N and 3P + N

- Disconnection of the phase and neutral in the normal dimensions of the phase (2 modules of 9 mm)
- Phase opening causes compulsory opening of the neutral
- The phase opens before the neutral on isolation and closes after the neutral on circuit closing



STI	Cartridges
IEC/EN 60947-3, IEC/EN 60269-2	IEC 60269-1, IEC 60269-2, NF C 60-200-2

- The STI isolatable fuse-carriers provide overload and short-circuit protection.
- They are used for industrial applications requiring a high breaking capacity.
- They perform the isolation function and must not be used as switches.
- To be equipped with aM or gG (gL - gl) type fuse cartridge without striker, with or without fuse blowing indicator.
- Isolation of all poles is guaranteed for the 2P, 3P, and 3P+N versions during factory assembly.

The general purpose fuse (**gG fuse**) provides overload and short-circuit protection. The fuse for motor application (**aM fuse**) only provides short-circuit protection. It is used for protection of loads with a high peak current (motors, transformer primaries, etc.).

Catalogue numbers

Fuse cartridge (Type F)					STI fuse holder						
Type	Rating	Voltage rating (Ue)	Short-circuit current (Isc)		Network type						
			aM	gG	aM	gG	1P	1P+N ⁽¹⁾	2P	3P	3P+N ⁽¹⁾
8.5 x 31.5 mm	2 A	400 V AC	20 kA	20 kA	DF2BA0200	DF2BN0200	A9N15635	A9N15645	A9N15650	A9N15655	A9N15657
	4 A	400 V AC	20 kA	20 kA	DF2BA0400	DF2BN0400					
	6 A	400 V AC	20 kA	20 kA	DF2BA0600	DF2BN0600					
	8 A	400 V AC	20 kA	20 kA	DF2BA0800	DF2BN0800					
	10 A	400 V AC	20 kA	20 kA	DF2BA1000	DF2BN1000					
10.3 x 38 mm	2 A	500 V AC	120 kA	120 kA	DF2CA02	DF2CN02	A9N15636	A9N15646	A9N15651	A9N15656	A9N15658
	4 A	500 V AC	120 kA	120 kA	DF2CA04	DF2CN04					
	6 A	500 V AC	120 kA	120 kA	DF2CA06	DF2CN06					
	10 A	500 V AC	120 kA	120 kA	DF2CA10	DF2CN10					
	16 A	500 V AC	120 kA	120 kA	DF2CA16	DF2CN16					
	20 A	500 V AC	120 kA	120 kA	DF2CA20	DF2CN20					
	25 A	400 V AC	120 kA	120 kA	DF2CA25	DF2CN25					

(1) The neutral pole comes equipped with a locked tube.

230 V neon indicator light (Option)

- Indicates fuse blowing (off in normal operation and lit red after fuse blowing)
- 400 V maxi

1P+N, 3P+N

- Phase opening causes compulsory opening of the neutral
- The phase opens before the neutral on isolation and closes after the neutral on circuit closing
- Small dimensions
 - 1P+N in 18 mm
 - 3P+N in 54 mm

Clip-on markers

Padlocking device

- Locks the toggle in the "open" or "closed" position. Used with an 8 mm max. diameter padlock (not supplied):
 - only one padlock for 1P, 1P+N and 2P products (on the left pole)
 - and two padlock on the 3P and 3P+N products (on every extremity)

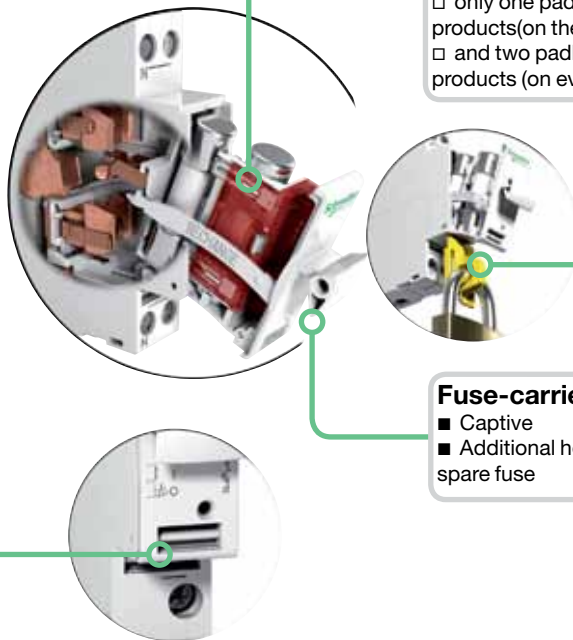

Fuse-carrier

- Captive
- Additional housing is provided for a spare fuse

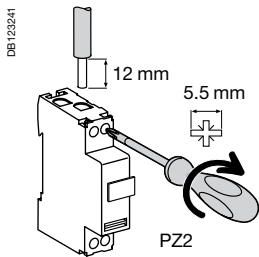

Connection



Type	Rating	Tightening torque	Without accessory		With accessories
			Copper cables Rigid	Flexible or ferrule	Screw-on connection for ring terminal
STI	All	2 N.m	DB122345  0.75 to 10 mm ² 2 x 0.75 mm ² to 2 x 4 mm ²	DB122346  0.5 to 6 mm ² 2 x 0.5 mm ² to 2 x 4 mm ²	DB116788  Ø 5 mm

1 Screw-on connection for ring terminal **27053**

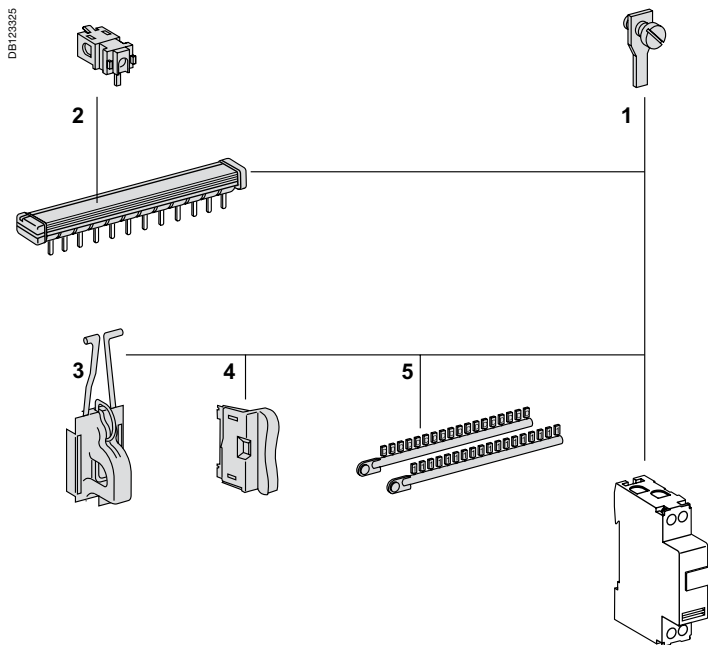

Mounting accessories

2 Comb busbar	See section 10	
3 Padlocking device		15669
4 Neon indicator light	1 piece blister	15668
5 Clip-on terminal markers	Use AB1 range	

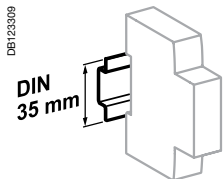

Clip on DIN rail 35 mm.

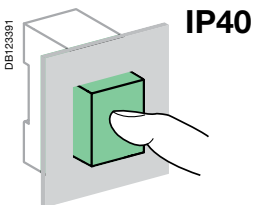

Technical data

Main characteristics

Insulation voltage (Ui)	500 V
Breaking capacity according to IEC 60269-2 ≤ 400 V	50 kA
Pollution degree	3
Operating frequency (Hz)	50/60

Additional characteristics

Degree of protection	Device in modular enclosure	IP40
		Insulation class II
Operating temperature		-20°C to +60°C
Storage temperature		-40°C to +80°C

Maximum dissipated power per pole of STI isolatable fuse-carriers

Fuse cartridge type		I _{th}	P _{max}
8.5 x 31 mm	aM	10 A	2.5 W
	gG	20 A	2.5 W
10.3 x 38 mm	aM	16 A	3 W
	gG	25 A	3 W

Maximum dissipated power per fuse cartridges

Fuse cartridge type		I _{th}	P _{max}
8.5 x 31 mm	aM	2 to 10 A	0.9 W
	gG	2 to 10 A	2.5 W
10.3 x 38 mm	aM	2 to 25 A	1.2 W
	gG	2 to 25 A	3 W

Dimensions (mm)

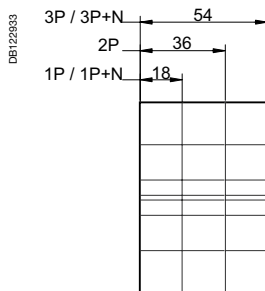

STI

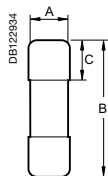
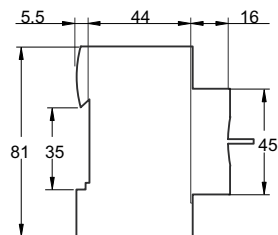

aM, gG

aM, gG fuse cartridge

Type	A	B	C
8.5 x 31.5 mm	8.5	31.5	10.3
10.3 x 38 mm	10.3	38	10.5



MGN15707



MGN15712



MGN15714



MGN15718

IEC EN 60947-3

- SBI fuse holders provide overload and short-circuit protection.
 - They are used for industrial applications requiring a high breaking capacity.
 - They perform the isolation function and must not be used as switches.
 - They are equipped with an indicator light indicating blowing of the fuse cartridge: to be equipped with aM or gG (gL-gl) type fuse cartridge without striker.
- The general purpose fuse (gG fuse) provides overload and short-circuit protection. The fuse for motor application (**aM fuse**) only provides short-circuit protection. It is used for protection of loads with a high peak current (motors, transformer primaries, etc.).

Catalogue numbers

Fuse cartridge						SBI fuse holder						
Type	Rating	Voltage rating (Ue)	Short-circuit current (Isc)				Network type					
			aM	gG	aM	gG	N	1P	1P+N ⁽¹⁾	2P	3P	3P+N ⁽¹⁾
14 x 51 mm	10 A	690 V CA	120 kA	120 kA	DF2EA10	DF2EN10						
	12 A	690 V CA	120 kA	-	DF2EA12	-						
	16 A	690 V CA	120 kA	120 kA	DF2EA16	DF2EN16						
	20 A	690 V CA	120 kA	120 kA	DF2EA20	DF2EN20						
	25 A	690 V CA	120 kA	120 kA	DF2EA25	DF2EN25						
	32 A	500 V CA	120 kA	120 kA	DF2EA32	DF2EN32						
	40 A	500 V CA	120 kA	120 kA	DF2EA40	DF2EN40						
22 x 58 mm	50 A	400 V CA	120 kA	120 kA	DF2EA50	DF2EN50						
	32 A	690 V CA	80 kA	80 kA	DF2FA32	DF2FN32						
	40 A	690 V CA	80 kA	80 kA	DF2FA40	DF2FN40						
	50 A	690 V CA	80 kA	80 kA	DF2FA50	DF2FN50						
	63 A	690 V CA	80 kA	80 kA	DF2FA63	DF2FN63						
	80 A	690 V CA	80 kA	80 kA	DF2FA80	DF2FN80						
	100 A	400 V CA	120 kA	120 kA	DF2FA100	DF2FN100						
125 A	400 V CA	120 kA	-	DF2FA125	-							

(1) The neutral pole comes equipped with a locked tube.

Local control selector switches

SBI fuse holder with indicator light (cont.)

Connection

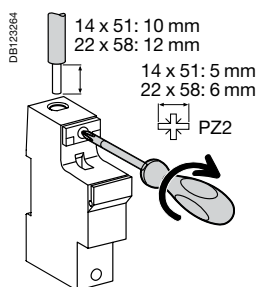

Type of fuse cartridge	Tightening torque	Copper cables		Multi-cables terminal	
		Rigid	Flexible or ferrule	Rigid cables	Flexible cables
14 x 51 mm	3.5 N.m	2.5 to 25 mm ²	2.5 to 25 mm ²	2.5 to 10 mm ²	2.5 to 10 mm ²
22 x 58 mm	3.5 N.m	2.5 to 35 mm ²	2.5 to 35 mm ²	2.5 to 25 mm ²	2.5 to 16 mm ²

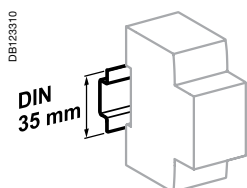

Clip on DIN rail 35 mm.

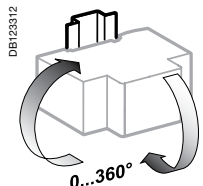

Indifferent position of installation.

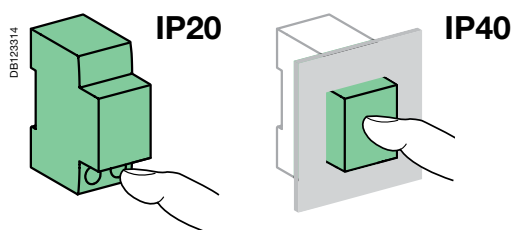

Technical data

Main characteristics

Insulation voltage (Ui)	690 V
Utilization category	AC20B isolation by switching the drawer, must not be operated under load

Additional characteristics

Degree of protection	Device only	IP20
	Device in modular enclosure	IP40
Operating temperature		-20°C to +60°C
Storage temperature		-40°C to +80°C
Cartridge blowing signalling		By indicator light ON (neon)

Maximum permissible characteristics of the fuse cartridges:

Fuse cartridge type	Ith	Pmax*
14 x 51 mm	aM	50 A 3 W
	gG	50 A 5 W
22 x 58 mm	aM	125 A 9.5 W
	gG	100 A 9.5 W

*Pmax: maximum dissipated power per fuse cartridge.

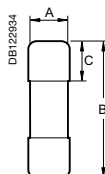
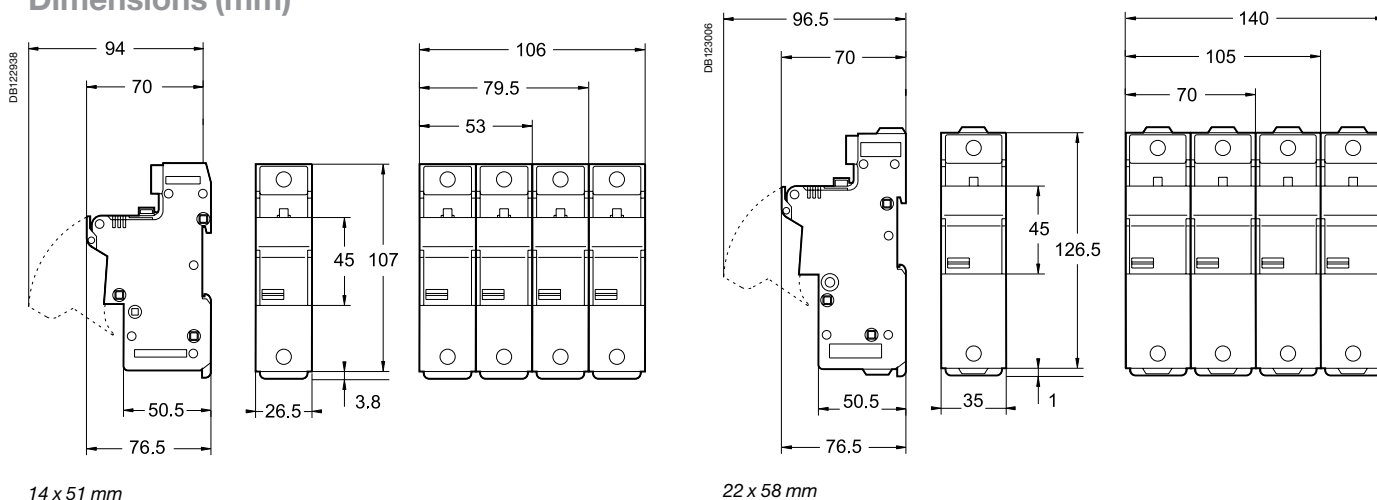

Dimensions (mm)





aM, gG fuse cartridge

Type	A	B	C
14 x 51 mm	14.3	51	13.8
22 x 58 mm	22.2	58	16.2

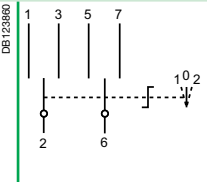
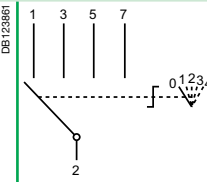
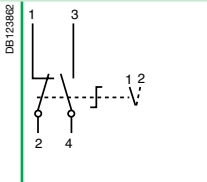
aM, gG

		Control																													
Selector switches		iCMB	iCMD	iCME																											
Type		Two-pole with zero setting	4-way	2-way for electronic circuits																											
In compliance with standards		IEC 60947-3 (EN 60947-3) VDE 0660 part. 107 UL	IEC 60947-3 (EN 60947-3) VDE 0660 part. 107 UL	IEC 60947-3 (EN 60947-3) VDE 0660 part. 107 UL																											
																															
Function		<ul style="list-style-type: none"> This two-pole selector switch with zero setting allows manual control of a circuit with 2-way operation with a stop position Key type Ronis 455 	<ul style="list-style-type: none"> This 4-way selector switch allows control of a circuit with operating priorities 	<ul style="list-style-type: none"> This 2-way selector switch is used specially for the control of electronic circuits of low voltage and current level 																											
Wiring diagrams																															
Use		Example: electrically controlled metal screen: <ul style="list-style-type: none"> position 1 = raising position 0 = stop position 2 = lowering 	Example: fan control: <ul style="list-style-type: none"> position 0 = stop position 1 = override operation, slow speed position 2 = override operation, high speed position 3 = remote control position 4 = automatic operation 	<ul style="list-style-type: none"> Voltage range from 30 mV to 600 V AC 																											
Catalogue numbers		A9E15120	A9E15121	A9E15122																											
Technical specifications																															
Rated voltage (Ue)	V AC	415	415	See following table																											
Maximum operating voltage	V	440	440	440																											
Rating	A	10	10	See following table																											
Operating frequency	Hz	50/60	50/60	50/60																											
Width in 9-mm modules		4	4	4																											
Breaking capacity (resistive load)		–	–	<table border="1"> <thead> <tr> <th></th> <th>V AC</th> <th>V DC</th> </tr> </thead> <tbody> <tr> <td>1 V</td> <td>5 A</td> <td>3 A</td> </tr> <tr> <td>12 V</td> <td>1.2 A</td> <td>0.7 A</td> </tr> <tr> <td>24 V</td> <td>0.7 A</td> <td>0.4 A</td> </tr> <tr> <td>48 V</td> <td>0.45 A</td> <td>0.25 A</td> </tr> <tr> <td>110 V</td> <td>0.25 A</td> <td>0.13 A</td> </tr> <tr> <td>240 V</td> <td>0.15 A</td> <td>0.08 A</td> </tr> <tr> <td>300 V</td> <td>0.13 A</td> <td>0.07 A</td> </tr> <tr> <td>440 V</td> <td>0.1 A</td> <td>0.05 A</td> </tr> </tbody> </table>		V AC	V DC	1 V	5 A	3 A	12 V	1.2 A	0.7 A	24 V	0.7 A	0.4 A	48 V	0.45 A	0.25 A	110 V	0.25 A	0.13 A	240 V	0.15 A	0.08 A	300 V	0.13 A	0.07 A	440 V	0.1 A	0.05 A
	V AC	V DC																													
1 V	5 A	3 A																													
12 V	1.2 A	0.7 A																													
24 V	0.7 A	0.4 A																													
48 V	0.45 A	0.25 A																													
110 V	0.25 A	0.13 A																													
240 V	0.15 A	0.08 A																													
300 V	0.13 A	0.07 A																													
440 V	0.1 A	0.05 A																													
Operating temperature	°C	-20...+55	-20...+55	-20...+55																											
Storage temperature	°C	-25...+80	-25...+80	-25...+80																											

7

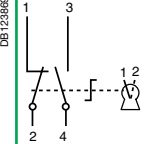
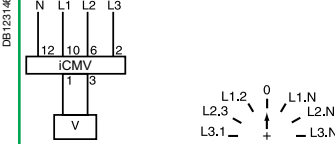
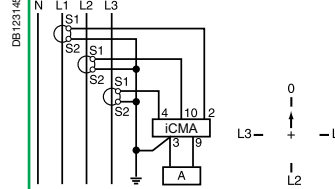
iCMC	iCMV	iCMA
2-way key-actuated	7-position voltmeter	4-position ammeter
IEC 60947-3 (EN 60947-3) VDE 0660 part. 107 UL	IEC 60947-3 (EN 60947-3) VDE 0660 part. 107 UL	IEC 60947-3 (EN 60947-3) VDE 0660 part. 107 UL
		
<p>■ 2-way key-actuated selector switch with locking in one or the other position</p>	<p>■ This 7-position voltmeter selector switch makes it possible, with a single voltmeter, to measure in succession the voltages (phase-to-phase and phase-to-neutral) of a three-phase circuit</p>	<p>■ This 4-position ammeter selector switch makes it possible, with a single ammeter (using current transformers), to measure in succession the currents of a three-phase circuit</p>
		
-	-	-
A9E15123	15125	15126
415	415	415
440	440	440
10	10	10
50/60	50/60	
4	4	4
-	-	-
-20...+55	-20...+55	-20...+55
-25...+80	-25...+80	-25...+80

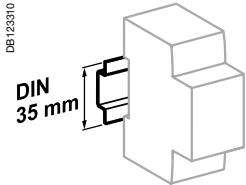

Clip on DIN rail 35 mm.

Connection

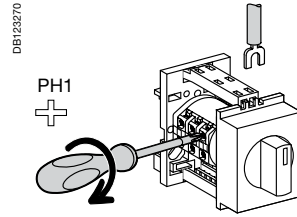

Tightening torque	Copper cables
0.35 N.m	Flexible or rigid with ferrule
	
	< 1.5 mm ²

DB123245

■ Connection by jumper terminals with captive screws.

Technical data

Additional characteristics		
Degree of protection	Device only	IP20
Endurance (O-C)	Electrical	1,000,000 switching operations
	Mechanical	2,000,000 switching operations (AC21A-3 x 440 V)

Weight (g)

Selector switches	
Type	
iCMA	58
iCMB	58
iCMC	70
iCMD	58
iCME	44
iCMV	58

Dimensions (mm)

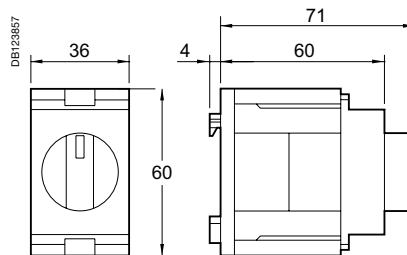



Application

The device holders can be mounted on 35mm rail to facilitate mounting of pushbuttons, indicators or other devices.

Technical data

Button holder

For buttons, switches and indicators with metal or plastic flange Ø 22 of the Telemecanique XB4 / XB5 type

Depth under rail:	60mm (same as products in the Acti 9 range)
-------------------	---

Drilling diameter:	Ø 22.3
--------------------	--------

Self-extinguishing insulating material	
--	--

Colour:	White RAL 9003
---------	----------------

Universal holder

For buttons, indicators, light emitting diodes (LED), potentiometers

Easy drilling	To be adapted depending on use
---------------	--------------------------------

Depth under rail	60 mm (same as products in the multi 9 range)
------------------	---

Self-extinguishing insulating material	
--	--

Colour:	Light grey RAL 7035
---------	---------------------

Type	Width in 18mm ways	Part number
22mm button holder	3	A9A15151
Universal holder	3	A9A15152

Monitoring Control Remote control

Relays

Time delay relays are used in service sector and industrial buildings for small automatic control systems: ventilation, heating, animation, roller blind servo controls, escalators, pumps, lighting, signalling, monitoring, etc.

> Time delay relays



iRTA
■ Delays energizing of a load



iRTB
■ Delays de-energizing of a load upon closing of an auxiliary contact (push button)



iRTC
■ Delays de-energizing of a load upon opening of an auxiliary contact (push button)

^ Time delay

iRBN and iRTBT relays can interface automatic control system inputs/outputs with low-voltage devices.

> Interface relays



iRBN
Low level relay
■ Actuation of low-amperage electronic circuits upon receiving an LV electrical order



iRTBT
Extra low voltage relay
■ Actuation of LV circuits based on an extra low voltage order

^ Control

Control relays monitor electrical parameters and indicate when they are exceeded

> Control relays



iRCP
Phase control
■ Monitors the order and asymmetry of phases and the presence of voltage on the 3 phases of a three-phase circuit (power supply of a motor, etc.)



iRCI
Current control
■ Monitors the current flowing in a circuit and indicates any crossing of the set threshold

^ Monitoring



iRTH

■ Applies a time delay to de-energizing of a load



iRTL

■ Applies a time delay to energizing and de-energizing of a load during different times, repeatedly (flasher)



iRTMF

■ Allows one of the four types of time delay to be selected: A, B, C or H

iRLI and iERL relays are used to relay ON or OFF information to the auxiliary circuits and actuate low-power loads

> **Changeover relays**



iRLI

Changeover

■ Relays ON or OFF information to the auxiliary circuits
■ Actuates low-power loads



iERL extension

^ **Relaying and control**



iRCU

Voltage control



■ Monitors the potential difference of a circuit and indicates any crossing of the set threshold





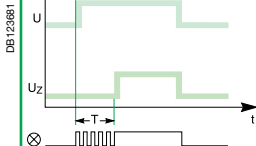
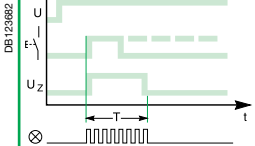
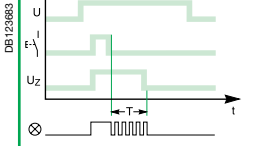

iRCC

Compressor control

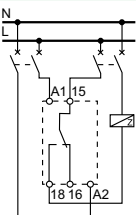
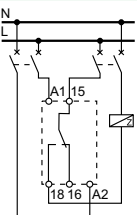
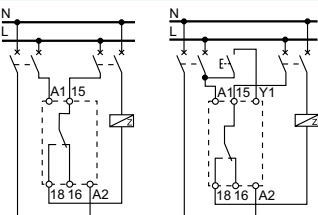
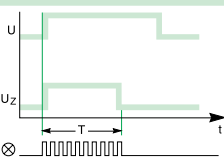
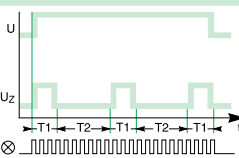

■ Monitors the compressor power supply and prevents its immediate restarting upon detection of a power cut or voltage dip



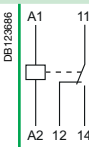
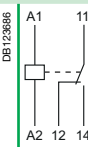

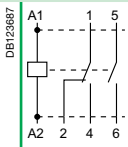
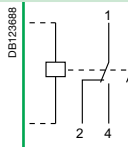

		Time delay relays		
		iRTA	iRTB	iRTC
Type				
Function		<ul style="list-style-type: none"> Delays energizing of a load 	<ul style="list-style-type: none"> Delays de-energizing of a load upon closing of an auxiliary contact (push button) 	<ul style="list-style-type: none"> Delays de-energizing of a load upon opening of an auxiliary contact (push button)
Wiring diagrams				
Use		 <ul style="list-style-type: none"> The single time delay cycle starts at switching on of the iRTA relay power supply The load is energized at the end of time delay T 	 <ul style="list-style-type: none"> The single time delay cycle starts at closing of an auxiliary contact (push button) The load is de-energized at the end of time delay T 	 <ul style="list-style-type: none"> The single time delay cycle starts only upon release of an auxiliary contact (push button) The load is de-energized at the end of time delay T
Catalogue numbers		A9E16065	A9E16066	A9E16067
Technical specifications				
Control and power supply voltage (Uc)	V AC	24...240, ±10 %	24...240, ±10 %	24...240, ±10 %
	V DC	24, ±10 %	24, ±10 %	24, ±10 %
Operating frequency	Hz	50/60	50/60	50/60
Time delay range		0.1 s to 100 h	0.1 s to 100 h	0.1 s to 100 h
Precision		±10 % of full scale	±10 % of full scale	±10 % of full scale
Minimum duration of control impulse		100 ms	100 ms	100 ms
Insensitive to brownouts		≤ 20 ms	≤ 20 ms	≤ 20 ms
Max. resetting time per voltage interruption		100 ms	100 ms	100 ms
Accuracy of repetition		±0.5 % at constant parameters	±0.5 % at constant parameters	±0.5 % at constant parameters
Changeover contact (cadmium free)	Mini	Rating 10 mA/5 V DC	Rating 10 mA/5 V DC	Rating 10 mA/5 V DC
	Maxi	Rating 8 A/250 V AC/DC	Rating 8 A/250 V AC/DC	Rating 8 A/250 V AC/DC
Endurance	Mechanical	> 5 x 10 ⁶ switching operations	> 5 x 10 ⁶ switching operations	> 5 x 10 ⁶ switching operations
	Electrical	> 10 ⁵ switching operations (utilization category AC1)	> 10 ⁵ switching operations (utilization category AC1)	> 10 ⁵ switching operations (utilization category AC1)
Display of contact status by green indicator lamp		Flashing during time delay	Flashing during time delay	Flashing during time delay
Degree of protection	Device only	IP20	IP20	IP20
Connection by tunnel terminals	Without ferrule	2 x 2.5 mm ² single-strand	2 x 2.5 mm ² single-strand	2 x 2.5 mm ² single-strand
	With ferrule	2 x 1.5 mm ² multi-strand	2 x 1.5 mm ² multi-strand	2 x 1.5 mm ² multi-strand
Width in 9-mm modules		2	2	2
Operating temperature	°C	-5 ... +55	-5 ... +55	-5 ... +55
Storage temperature	°C	-40 ... +70	-40 ... +70	-40 ... +70

	iRTH	iRTL	iRTMF
			
	<ul style="list-style-type: none"> Applies a time delay to de-energizing of a load 	<ul style="list-style-type: none"> Applies a time delay to energizing and de-energizing of a load during different times, repeatedly (flasher) 	<ul style="list-style-type: none"> Allows one of the four types of time delay to be selected: A, B, C or H
			
			
	<ul style="list-style-type: none"> The single time delay cycle starts at switching on of the iRTH relay power supply The load is de-energized at the end of time delay T 	<ul style="list-style-type: none"> The time delay cycle starts at energizing The load is energized during an adjustable time T1 and then de-energized during an adjustable time T2. This cycle is reproduced until de-energizing of the iRTL relay power supply 	<ul style="list-style-type: none"> Depending on the choice, the iRTMF generates time delay cycles for the iRTA, iRTB, iRTC or iRTH relays
	A9E16068	A9E16069	A9E16070
	24...240, ±10 %	24...240, ±10 %	12...240, ±10 %
	24, ±10 %	24, ±10 %	12...240, ±10 %
	50/60	50/60	50/60
	0.1 s to 100 h	0.1 s to 100 h	0.1 s to 100 h
	±10 % of full scale	±10 % of full scale	±10 % of full scale
	100 ms	100 ms	100 ms
	≤ 20 ms	≤ 20 ms	≤ 20 ms
	100 ms	100 ms	100 ms
	±0.5 % at constant parameters	±0.5 % at constant parameters	±0.5 % at constant parameters
	Rating 10 mA/5 V DC	Rating 10 mA/5 V DC	Rating 10 mA/5 V DC
	Rating 8 A/250 V AC/DC	Rating 8 A/250 V AC/DC	Rating 8 A/250 V AC/DC
	> 5 x 10 ⁶ switching operations	> 5 x 10 ⁶ switching operations	> 5 x 10 ⁶ switching operations
	> 10 ⁵ switching operations (utilization category AC1)	> 10 ⁵ switching operations (utilization category AC1)	> 10 ⁵ switching operations (utilization category AC1)
	Flashing during time delay	Flashing during time delay	Flashing during time delay
	IP20	IP20	IP20
	2 x 2.5 mm ² single-strand	2 x 2.5 mm ² single-strand	2 x 2.5 mm ² single-strand
	2 x 1.5 mm ² multi-strand	2 x 1.5 mm ² multi-strand	2 x 1.5 mm ² multi-strand
	2	2	2
	-5 ... +55	-5 ... +55	-5 ... +55
	-40 ... +70	-40 ... +70	-40 ... +70

Interface relays			
	iRBN	iRTBT	
Type	Low level	Extra low voltage	
	 PBE107144-35	 PBE107164-35	
Standard	IEC 255 100 and IEC 529	IEC 255 100 and IEC 529	
Function	<ul style="list-style-type: none"> Actuation of low-amperage electronic circuits upon receiving an LV electrical order 	<ul style="list-style-type: none"> Actuation of LV circuits based on an extra low voltage order 	
Wiring diagrams	 DB123686	 DB123686	
Use	<ul style="list-style-type: none"> Inputs of programmable logic controllers, of measuring or supervision circuits, etc. 	<ul style="list-style-type: none"> ELV orders can be issued by a programmable logic controller (24 V DC static outputs), a central fire detection unit, a regulation system, etc. 	
Catalogue numbers	A9A15393	A9A15416	
Technical specifications			
Input control voltage (Uc)	V AC	230, ±10 %	12...24, -15 to +10 %
	V DC	-	12...24, ±20 %
Output contact rating	Mini	5 mA/5 V DC (DC12) 5 mA/5 V AC	10 mA/10 V DC (DC12) 10 mA/10 V AC
	Maxi	1 A/24 V DC (DC12) 5 A/250 V AC	1 A/24 V DC (DC12) 5 A/250 V AC
Operating frequency	Hz	50/60	0...60
Strengthened insulation between ELV/LV circuits		4 kV	4 kV
Consumption	At inrush	5 VA	0.22 W
	At holding	2.5 VA	0.11 W
Endurance	Electrical	100,000 switching operations	100,000 switching operations
Display of voltage presence on the control circuit		By green indicator lamp	By green indicator lamp
Degree of protection	Device only	IP20	IP20
Connection by tunnel terminals		0.5 x 6 mm ²	0.5 x 6 mm ²
Width in 9-mm modules		2	2
Operating temperature	°C	-5 ... +55	-5 ... +55
Storage temperature	°C	-40 ... +70	-40 ... +70

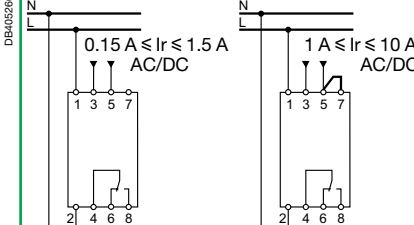
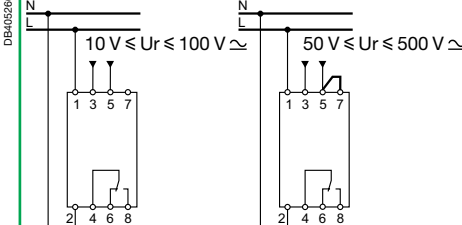







Changeover and extension relays

	iRLI				iERL				
Type	Changeover relay				Extension for RLI				
									
Standard	IEC 255 and NF C 45-250				IEC 255 and NF C 45-250				
Function	<ul style="list-style-type: none"> Relaying of ON or OFF information to the auxiliary circuits and actuation of low-power loads 				<ul style="list-style-type: none"> Extension allowing additional contacts to be added to the iRLI changeover relays 				
Wiring diagrams									
Use	<ul style="list-style-type: none"> The iRLI relay contains 1 changeover contact (O-C) and 1 normally open contact (N/O) 				<ul style="list-style-type: none"> The iERL extension (max. 3 iERLs for 1 iRLI) contains 1 changeover contact (O-C) and 1 normally open contact (N/O) Can be mounted without any tool and without additional cabling using a yellow clip which performs mechanical assembly and electrical connection between the coils 				
Catalogue numbers	A9E15535	A9E15536	A9E15537	A9E15538	A9E15539	A9E15540	A9E15541	A9E15542	
Technical specifications									
Control voltage (Uc)	V AC	230...240	48	24	12	230...240	48	24	12
Voltage rating (Ue)	V AC	230							
Insulation voltage (Ui)	V AC	250							
Rating (In)	A	10, cos φ = 1				10, cos φ = 1			
Operating frequency	Hz	50/60				50/60			
Inrush and holding power		4 VA				iRLI + iERL : 8 VA			
Endurance	Electrical	100,000 cycles AC21 (cos φ = 1)				100,000 cycles AC21 (cos φ = 1)			
Operation on front face	Power	By push button				By push button			
	Coil	By selector switch (disconnection)				By selector switch (disconnection)			
Position indicator		Mechanical indicator				Mechanical indicator			
Marking		Clip-on markers on the front panel				Clip-on markers on the front panel			
Degree of protection	Device only	IP20				IP20			
Connection by tunnel terminals		0.5 x 6 mm ²				0.5 x 6 mm ²			
Width in 9-mm modules		2				2			
Operating temperature	°C	-5 ... +55				-5 ... +55			
Storage temperature	°C	-40 ... +70				-40 ... +70			

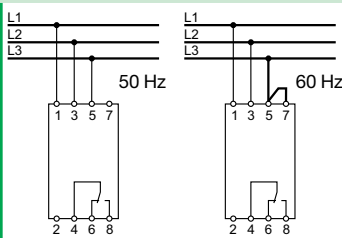
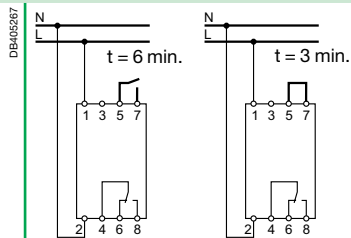
		Control relays	
		iRCI	iRCU
Type		Current control	Voltage control
			
Function		<ul style="list-style-type: none"> Monitors the current (I_r) flowing in an AC or DC circuit and indicates any crossing of the set threshold 	<ul style="list-style-type: none"> Monitors the voltage variation (U_r) of an AC or DC circuit and indicates any crossing of the set threshold
Wiring diagrams			
Catalogue numbers		A9E21181	A9E21182
Common technical specifications			
Supply voltage (U_c)	V AC	230, -15 % to +10 %	
Frequency	Hz	50/60	
Parameter setting		<ul style="list-style-type: none"> On the front panel, by direct scale, using a screwdriver 	
Precision of display		±10 % of full scale	
Output by changeover contact		8 A under 250 V AC ($\cos \varphi = 1$)	
Indications by LED	Green	Voltage presence	
	Red	Fault	
Consumption	VA	3	
Dissipated power	W	2	
Degree of protection	Device only	IP20	
Connection by tunnel terminals	Rigid cable	1.5 x 6 mm ²	
Width in 9-mm modules		4	
Operating temperature	°C	-5 ... +55	
Storage temperature	°C	-40 ... +80	
Particular technical specifications			
		Threshold adjustable from 10 % to 100 % of I_r	Threshold adjustable from 10 % to 100 % of U_r
		Hysteresis adjustable from 5 % to 50 % of I_r	Hysteresis adjustable from 5 % to 50 % of U_r
		Monitoring of overcurrent and undercurrent (selection by selector switch)	
		Fail-safe contact	
		De-energized	
		Energized with fault	
		Energized without fault	
		Time delay on crossing threshold: 0.1 s to 10 s	
		Possibility of memorizing fault with resetting	
		Compatible with current transformers (CTs) of ratio X/5	<ul style="list-style-type: none"> Automatic recognition of AC voltage or DC voltage. 2 measuring ranges selected by cabling: <ul style="list-style-type: none"> 10 V to 50 V 50 V to 500 V
		<ul style="list-style-type: none"> Automatic recognition of alternating or direct current. 2 measuring ranges selected by cabling: <ul style="list-style-type: none"> 0.15 A to 1.5 A 1 A to 10 A 	

Monitoring Control Remote control

iRCP phase control, iRCI current control, iRCU voltage control and iRCC compressor control relays (cont.)

iRCP		iRCC	
Phase control		Compressor control	
PB107124-3E		PB107127-3E	
<p>■ Monitors phases and the presence of voltage on the 3 phases of a three-phase circuit (power supply of a motor, etc.). It indicates any phase loss or inversion</p>		<p>■ Monitors the compressor's power supply and prevents its immediate restarting upon detection of a power cut or voltage dip</p>	
DB405265	 <p>50 Hz 60 Hz</p>	DB405267	 <p>t = 6 min. t = 3 min.</p>
A9E21180		A9E21183	
400, ±15 %		230, -15 % to +10 %	
50/60			
■ On the front panel, by direct scale, using a screwdriver			
±10 % of full scale			
8 A under 250 V AC (cos φ = 1)			
Voltage presence			
Fault			
3		2	
3 (total on the 3 phases)			
IP20			
1.5 x 6 mm ²			
4			
-5 ... +55			
-40 ... +80			
Setting of phase asymmetry threshold: 5 % to 2.5 % of 400 V		Threshold setting: ±5 % to ±15 % of 230 V	
Hysteresis: fixed, 5 % of asymmetry threshold			
Monitoring of direction of phase rotation			
Monitoring of presence of the 3 phases			
Fail-safe contact		Fail-safe contact	
De-energized		De-energized	
Energized with fault		Energized with fault	
Energized without fault		Energized without fault	
Time delay on tripping: 0.3 s		Time delay on overshoot: 3 or 6 minutes (selection by cabling)	

Technical data

Weight (g)

Relays	
Type	
iRTA, iRTB, iRTC, iRTH, iRBN	65
iRTL	66
iRTMF	68
iRTBT	63
iRLI, iERL	112
iRCP, iRCC	210
iRCI, iRCU	215

Dimensions (mm)

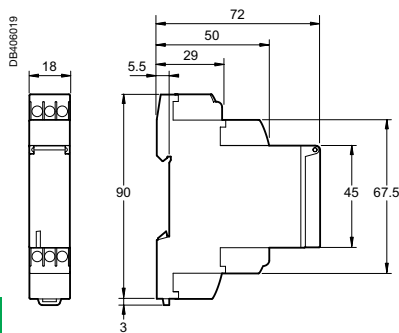

iRTA, iRTB, iRTC, iRTH, iRTL, iRTMF

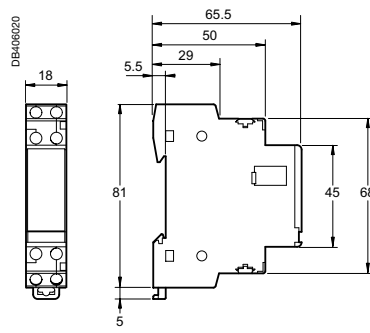

iRBN, iRTBT

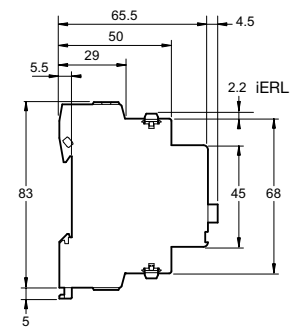

iRLI, iERL

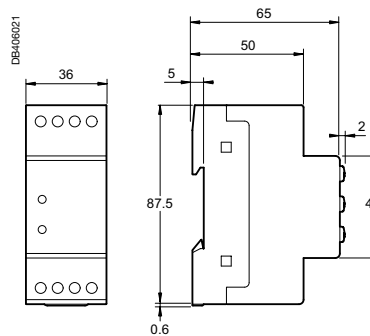

iRCP, iRCI, iRCU, iRCC

> Timers

> Electromechanical timer

MIN
Adjustable time delay from 1 to 7 min.

The image shows a single Schneider MIN timer, model P111648, which is an electromechanical timer. It is a vertical, rectangular device with a white face and a green Schneider logo. It has several terminals at the top and bottom.

> Silent electronic timers

MINs
Adjustable time delay from 0.5 to 20 min.



MINp
Adjustable time delay from 0.5 to 20 min. with switch-off warning.

MINT
Adjustable time delay from 0.5 to 20 min. with switch-off warning and impulse relay function.

The image shows three Schneider silent electronic timers: MINs (P111642), MINp (P111643), and MINT (P111644). They are vertical, rectangular devices with white faces and green Schneider logos. Each has a different set of features and terminals.

Selection table

	MIN	MINs
Type	Electromechanical timer	Silent electronic timer
Function	<p>These timers allow closing and then opening of a contact in a determined time</p> <p>Control circuit: connected standard or luminous push-buttons.</p> <p>Timer inoperative via self-protection if consumption above 50 mA maximum</p>	
Wiring diagrams		
Mounting	<p>Two operating modes triggered by switch on front face:</p> <ul style="list-style-type: none"> ■ Automatic mode: <ul style="list-style-type: none"> □ operation in timing mode □ time delay adjustable from 1 to 7 min. □ setting in steps of 15 s using knob □ pressing a push-button renews the time delay ■ Manual override mode: constant lighting 	<p>Two operating modes triggered by switch on front face:</p> <ul style="list-style-type: none"> ■ Timer mode: time delay adjustable from 0.5 to 20 min. ■ Permanent mode: constant lighting
Catalogue numbers	15363	CCT15232
Technical specifications		
Voltage rating (Ue) (+10 %, -15 %)	230 V AC, 50 Hz	230 V AC, 50/60 Hz
Consumption	1 VA	< 6 VA
Output contact current Cos φ = 1	16 A	16 A
Degree of protection	IP20B	IP20B
Operating temperature	-10°C to +50°C	-10°C to +50°C
Width (9 mm modules)	2	2
Consumption of connected luminous push-buttons	50 mA maxi	150 mA maxi
Adjustable time delay	1 to 7 min.	0.5 to 20 min.
Long time delay	-	-
Insulation class	-	Class II
1 screw connection per pole for cables up to 6 mm ²	■	■
Selection of the type of connection (3 or 4 wires)	Selector switch	Automatic
Mechanical compatibility with electrical distribution comb busbar	-	■
Switch-off warning function	-	-
Impulse relay function	-	-

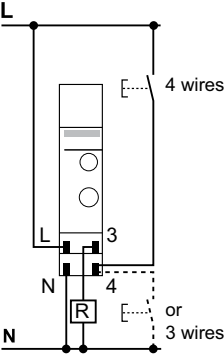
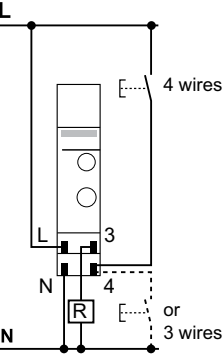
MINp		MINt		Accessory	
Silent electronic timer 				Wall mount accessory 	
<p>The MINp timer allows closing and then opening of a contact in a determined time, and it also provides warning that the lighting is about to be switched off by flickering of the lamplight (switch-off warning)</p>		<p>The MINt timer is the same as MINp with an "impulse relay" additional function</p>		<p>The MIN timers can be mounted on a wall by using 15359 reference. The protection cover is sealable.</p>	
				<p>The 15359 accessory can be also used to mount others 18 mm DIN rail devices (for example: time switches, circuit breakers...).</p>	
<ul style="list-style-type: none"> ■ Time delay adjustable from 0.5 to 20 min. ■ Three operating modes triggered by switch on front face: <ul style="list-style-type: none"> <input type="checkbox"/> timer mode with "switch-off warning" function built into the device. The lamp blinks 40 and 30 s before the end of the time delay <input type="checkbox"/> timer mode mode without "switch-off warning" function <input type="checkbox"/> permanent mode : constant lighting ■ Timer mode operation: <ul style="list-style-type: none"> <input type="checkbox"/> pressing a push-button for longer than 2 s: lighting will last for 1 h. Pressing again a push-button for less than 2 s relaunch the time delay of 1 h and pressing again a push-button for more than 2 s switches off the light <input type="checkbox"/> pressing a push-button for less than 2 s launch the pre-set time delay, pressing again a push-button for less than 2 s relaunch the pre-set time delay 		<ul style="list-style-type: none"> ■ Timer mode operation: <ul style="list-style-type: none"> <input type="checkbox"/> pressing a push-button for longer than 2 s: lighting will last for 1 h. Pressing again a push-button for less than 2 s relaunch the time delay of 1 h and pressing again a push-button for more than 2 s switches off the light <input type="checkbox"/> pressing a push-button for less than 2 s launch the pre-set time delay, pressing again a push-button for less than 2 s, switches off the light (impulse relay mode) 			
CCT15233		CCT15234		15359	
230 V AC, 50/60 Hz		230 V AC, 50/60 Hz			
< 6 VA		< 6 VA			
16 A		16 A			
IP20B		IP20B			
-25°C to +50°C		-25°C to +50°C			
2		2		See § dimensions	
150 mA maxi		150 mA maxi			
0.5 to 20 min.		0.5 to 20 min.			
1 h		1 h			
Class II		Class II			
■ Automatic		■ Automatic			
■		■			
■		■			
-		■			



Load table

Products	MIN	MINs	MINp, MINt
Type of lighting	Maximum power		
230 V incandescent and halogen lamps	2300 W	2300 W	3600 W
Non-corrected / serial-corrected / dual mounted fluorescent tubes with conventional ballast	2300 VA	2300 VA	3600 VA ⁽¹⁾
Fluocompact lamps with conventional ballast	2000 VA	1500 VA	1500 VA ⁽¹⁾
Parallel-corrected fluorescent tubes with conventional ballast	1300 VA (70 F)	400 VA (42 µF)	1200 VA (120 µF) ⁽¹⁾
Fluorescent tubes with electronic ballast	300 VA	300 VA	1000 VA
Fluocompact lamps with electronic ballast	9 x 7 W, 6 x 11 W, 5 x 15 W, 5 x 20 W	9 x 7 W, 7 x 11 W, 7 x 15 W, 7 x 20 W, 7 x 23 W	34 x 7 W, 27 x 11 W, 24 x 15 W, 22 x 23 W

⁽¹⁾ The "switch-off warning" function is not available for these types of loads.

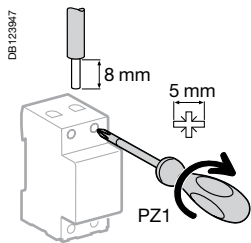
Connection



Type	Tightening torque	Copper cables	
		Rigid	Flexible or with ferrule
MIN, MINs, MINp, MINt	1.2 N.m	 ≤ 6 mm ²	 ≤ 6 mm ²

Weight (g)

Time switches	
MIN	84
MINs	75
MINp	103
MINt	76

Dimensions (mm)

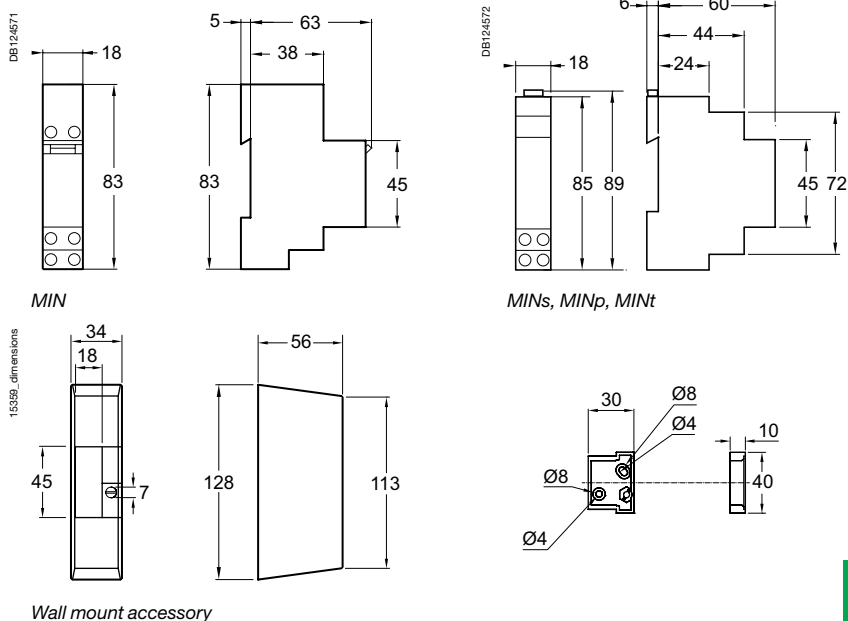

> Time switches

> The 45 mm digital time switches



IHP 1c **IHP 2c** **IHP+1c** **IHP+2c**

Automatically switch On and Off loads according to the program entered by the user with 4 keys and a display, they operate on a weekly cycle: the same program is repeated week after week.

> The 18 mm digital time switches



IHP 1c/+ 1c

Automatically switch On and Off loads according to the program entered by the user with 4 keys and a display, they operate on a weekly cycle: the same program is repeated week after week.

> The 54 mm mechanical time switches

IH 60mn 1c SRM **IH 24h 1c SRM/ARM** **IH 24h 2c ARM**

IH 24h + 7j 1c ARM **IH 7j 1c ARM**

Automatically switch On and Off loads according to the program entered by the user they operate on an hourly, daily or weekly cycle: the same program is repeated hour after hour (IH 60mn), day after day (IH 24h) or week after week (IH 7j).

> The 18 mm mechanical time switches

IH 24h 1c SRM/ARM **IHH 7j 1c ARM**

Automatically switch On and Off loads according to the program entered by the user they operate daily on a weekly cycle.

> The digital yearly time switches

ITA 1C **ITA 4C**

They operate on an daily, weekly or yearly program (ITA 1c: 1 channel, ITA 4c: 1, 2, 3 or 4 channels - 2 external inputs).

Selection table

The time switches control opening and closing of one or more separate circuits according to a programming pre-set by the user:

- by memorisation of On and Off switching operations for the IHP and ITA digital time switches
- by positioning of jumpers or captive segments on a programming dial for the IH mechanical time switches.

An IHP, IH or ITA time switch is chosen according to the following criteria:

Designation	Number of channels	Cycle period (d: day)	Minimum time between 2 switching operations	Number of switching operations	Saving on mains cut off	Width (modules of 9 mm)	Override controls On / Off	Output contact changeover switch (cos φ =1)	Time changeover (summer / winter)
The 45 mm digital time switches									
IHP 1c	1	24 h and/or 7 d	1 min.	56	6 years	5	On / Off	16 A	Auto
IHP + 1c	1	24 h and/or 7 d	1 s	84	6 years	5	On / Off	16 A	Auto
IHP 2c	2	24 h and/or 7 d	1 min.	56	6 years	5	On / Off	16 A	Auto
IHP + 2c	2	24 h and/or 7 d	1 s	84	6 years	5	On / Off	16 A	Auto
The 18 mm digital time switches									
IHP 1c 18 mm	1	24 h and/or 7 d	1 min.	56	10 years	2	On / Off	16 A	Auto
IHP + 1c 18 mm	1	24 h and/or 7 d	1 min.	84	10 years	2	On / Off	16 A	Auto
The 36 or 72 mm digital yearly time switches									
ITA 1c	1	24 h, 7 d, year	1 min.	300	10 years	4	On/Off	16 A	Manual / Auto
ITA 4c	4	24 h, 7 d, year	1 min.	300	10 years	8	On/Off	10 A	Manual / Auto
The 54 mm mechanical time switches									
IH 60mn 1c SRM	1	60 min.	37.5 s	48 On - 48 Off	none	6	On / Off	10 A	Manual
IH 24h 1c SRM	1	24 h	15 min.	48 On - 48 Off	none	6	On / Off	16 A	Manual
IH 24h 1c ARM	1	24 h	15 min.	48 On - 48 Off	200 h ⁽¹⁾	6	On / Off	16 A	Manual
IH 24h 2c ARM	2	24 h	30 min.	24 On - 24 Off	150 h	6	On	16 A	Manual
IH 7j 1c ARM	1	7 days	2 h	42 On - 42 Off	200 h ⁽¹⁾	6	On / Off	16 A	Manual
IH 24h + 7j 1+1c ARM	1+1	24 h + 7 days	45 min. + 12 h	16 On -16 Off + 7 On -7 Off	150 h	6	On	16 A	Manual
The 18 mm mechanical time switches									
IHH 7j 1c ARM	1	7 days	2 h	42 On - 42 Off	100 h	2	On / Off	16 A	Manual
IH 24h 1c ARM	1	24 h	15 min.	48 On - 48 Off	100 h	2	On / Off	16 A	Manual
IH 24h 1c SRM	1	24 h	15 min.	48 On - 48 Off	none	2	On / Off	16 A	Manual

⁽¹⁾ 10 h for 100 V CA supply voltage.

7

Back-lit display, random function and pulse programming	"Absence for holidays" function	Screwless connection	Mechanical compatibility with electrical distribution comb busbars	Input for external control	Instruction manual holder on front face	Memory key supplied with the product	Cat. no.
	■	■	■		■		CCT15720 ⁽⁴⁾
■	■	■	■	1 input	■	■	CCT15721 ⁽⁴⁾
	■	■	■		■		CCT15722 ⁽⁴⁾
■	■	■	■	2 inputs	■	■	CCT15723 ⁽⁴⁾
	■	■				⁽⁵⁾	CCT15854 ⁽⁴⁾
■ + Cycle programming	■	■		1 input		■	CCT15838 ⁽⁴⁾
Back-lit display, pulse and cycle programming	■ ⁽³⁾					⁽⁶⁾	CCT15910
Back-lit display, pulse and cycle programming	■ ⁽³⁾			2 inputs		⁽⁶⁾	CCT15940
		■					CCT15338
		■					CCT16364
		■					CCT15365
							15337
		■					CCT15367
							15366
							15331
							15336
							15335

⁽²⁾ French, English, Italian, Spanish, German, Portuguese languages.





⁽³⁾ Function included and can be realized through special program entry.

⁽⁴⁾ French, English, Italian, Spanish, German, Portuguese, Dutch languages.

⁽⁵⁾ Memory key (CCT15861) is not supplied with IHP 1c 18mm (CCT15854) but this memory key and the programming kit (CCT15860) can be used and operate on IHP 1c 18mm (see "Accessories selection table").

⁽⁶⁾ Memory key (CCT15955) is not supplied with ITA 1c/4c but this memory key and the programming kit (CCT15950) can be used and operate on ITA 1c/4c (see "Accessories selection table").

Selection table Programmable time switches

	IHP 1c	IHP2c	IHP+1c	IHP+2c
P140826		P140827	P111824	P111826
				

Function



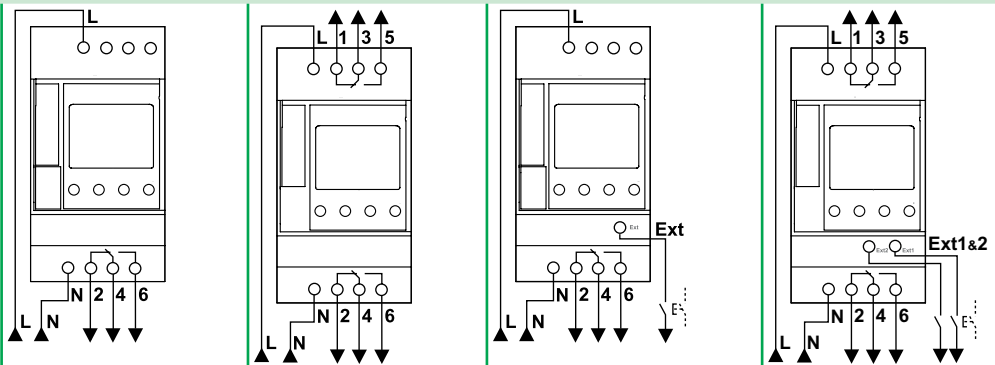

- These time switches automatically switch on and off loads according to the program entered by the user
 - They operate on weekly cycle: the same program is repeated week after week
 - They offer automatic summer/winter time change and allow to adjust it according to where you are located
 - The program can be overridden temporary or permanently by pressing 2 keys on the product
 - They also offer holidays program, by configuring the starting and ending dates of the absence.
- A memory key and a programming kit can be used to duplicate on another IHP+ or to save the program created by the contractor (see "Accessories selection table")
 - Override control with switch or push-button via external input (1 external input for IHP+1c and 2 external inputs for IHP+ 2c)

Wiring diagrams



Catalogue numbers	CCT15720	CCT15722	CCT15721	CCT15723
Technical specifications				
Voltage rating (Ue)	230 V AC, ±10 %, 50/60 Hz	230 V AC, ±10 %, 50/60 Hz	230 V AC, ±10 %, 50/60 Hz	230 V AC, ±10 %, 50/60 Hz
Consumption	4 VA	7 VA	4 VA	7 VA
Output contact current (250 V AC)	Cos φ = 1	16 A	16 A	16 A
	Cos φ = 0.6	10 A	10 A	10 A
Degree of protection	IP20B	IP20B	IP20B	IP20B
Operating temperature	-10°C to +50°C	-10°C to +50°C	-10°C to +50°C	-10°C to +50°C
Time accuracy	± 1 s per day at 20°C	± 1 s per day at 20°C	± 1 s per day at 20°C	± 1 s per day at 20°C
Program saving and time by lithium battery	Lifetime	6 years	6 years	6 years
	Back-up time, cumulated mains cut off	6 years	6 years	6 years

Yearly programmable time switches



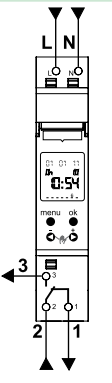
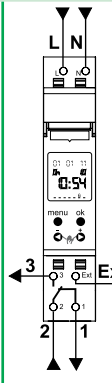
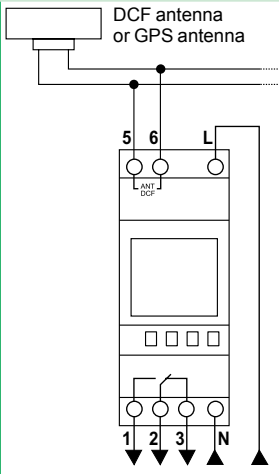
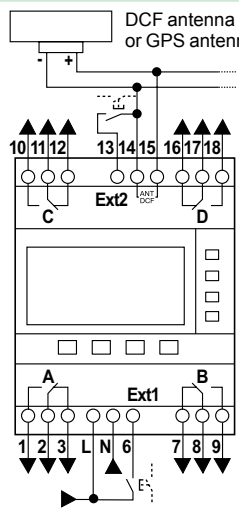

IHP 1c 18 mm	IHP+1c 18 mm	ITA 1c	ITA 4c
			

<ul style="list-style-type: none"> ■ A memory key and a programming kit can be used to duplicate on another IHP or to save the program created by the contractor (see "Accessories selection table") 	<ul style="list-style-type: none"> ■ Weekly or yearly time programming to be distributed over 1 channel 	<ul style="list-style-type: none"> ■ Weekly or yearly time programming to be distributed over 1, 2, 3 or 4 channels ■ Override control with switch or push-button via external inputs 	<ul style="list-style-type: none"> ■ A memory key and a programming kit can be used to duplicate on another ITA or to save the program created by the user (see "Accessories selection table").
---	--	---	--

			
CCT15854	CCT15838	CCT15910	CCT15940

230 V AC, +10 %, -15 %, 50/60 Hz	230 V AC, +10 %, -15 %, 50/60 Hz	230 V AC, 50/60 Hz	230 V AC, 50/60 Hz
2.3 VA	2.3 VA	1.4 - 1.9 W (depending on the switching status)	1.2 - 3.2 W (depending on the switching status)
16 A	16 A	16 A	10 A
4 A	4 A	6 A	6 A
IP20B	IP20B	IP20	IP20
-25°C to +55°C	-25°C to +55°C	-30 °C to +55 °C	-30 °C to +55 °C
± 0.5 s per day at 25°C	± 0.5 s per day at 25°C	Without antenna: ± 0.5 s per day at 20 °C With antenna: 1 s on 1 million years	Without antenna: ± 0.5 s per day at 20 °C With antenna: 1 s on 1 million years
10 years	10 years	10 years	10 years
10 years	10 years	10 years	10 years

Selection table Mechanical time switches

	IH 60mn 1c SRM	IH 24h 1c SRM	IH 24h 1c ARM	IH 24h 2c ARM			
P118680		P118681		P118682		P118616	

Function

- They operate on hourly, daily or weekly cycle: the same program is repeated hour after hour (IH 60mn), day after day (IH 24h) or week after week (IH 7), (IHH 7)
- The program can be overridden On

Wiring diagrams

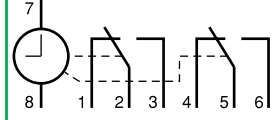
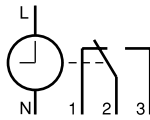
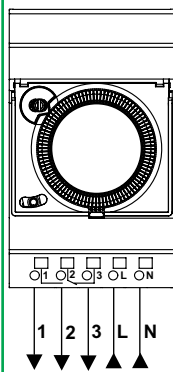



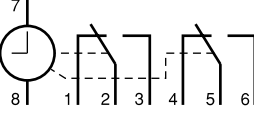
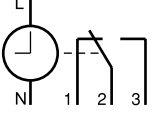
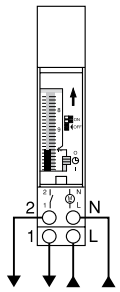

Catalogue numbers		CCT15338	CCT16364	CCT15365	15337
Technical specifications					
Voltage rating (Ue)		230 V AC +10 %, -15%, 50 Hz	230 V AC +10 %, -15%, 50/60 Hz	110-230 V AC +10 %, -15%, 50/60 Hz	230 V AC +10 %, -15%, 50/60 Hz
Consumption		1 VA	2.5 VA	2.5 VA	2.5 VA
Output contact current under 250 V AC	Cos φ = 1	10 A	16 A	16 A	16 A
	Cos φ = 0.6	4 A	4 A	4 A	4 A
Degree of protection		IP20B	IP20B	IP20B	IP20B
Operating temperature		-20°C to +55°C	-20°C to +55°C	-20°C to +55°C	-20°C to +55°C
Time accuracy		±1 s per day at 20°C	±1 s per day at 20°C	±1 s per day at 20°C	±1 s per day at 20°C
Saving of program and time by lithium battery	Lifetime	-	-	6 years	6 years
	Back-up time, cumulated mains cut off	-	-	200 h with 230 V AC 100 h with 100 V AC	150 h
Programming by:	Jumpers (supplied)	-	-	-	4 red + 4 green + 2 white
	Captive segments	96	96	96	-

	IH 24h + 7j 1+1c ARM	IH 7j 1c ARM	IH24h 1c SRM 18 mm	IH 24h 1c ARM 18 mm	IHH 7j 1c ARM 18 mm
P111619		P111663	P111614	P111615	P111613

				
---	---	--	--	--

	15366	CCT15367	15335	15336	15331
	230 V AC +10 %, -15%, 50 Hz	110-230 V AC +10 %, -15%, 50/60 Hz	230 V AC, ±10 %, 50/60 Hz	230 V AC, ±10 %, 50/60 Hz	230 V AC, ±10 %, 50/60 Hz
	2.5 VA	2.5 VA	2.5 VA	2.5 VA	2.5 VA
	16 A	16 A	16 A	16 A	16 A
	4 A	4 A	4 A	4 A	4 A
	IP20B	IP20B	IP20B	IP20B	IP20B
	-20°C to +55°C	-20°C to +55°C	-10°C to +50°C	-10°C to +50°C	-10°C to +50°C
	±1 s per day at 20°C	±1 s per day at 20°C	±1 s per day at 20°C	±1 s per day at 20°C	±1 s per day at 20°C
	6 years	6 years	10 years	10 years	10 years
	150 h	200 h with 230 V AC 100 h with 110 V AC	–	100 h	100 h
	6 yellow (24 h), 12 blue + 2 red (7 days)	–	–	–	–
	–	84	96	96	84

Accessories selection table

Accessories selection table	Programming kits for PC		Memory keys	
	IHP+	ITA	IHP+	ITA
				
Function	Consists of a programming device, a memory key, a CDROM and a 2 m USB cable For IHP+ 1c/2c, IHP 1c 18 mm, IHP+ 1c 18 mm	Consists of a programming device, a CDROM and a 1.5 m USB cable For ITA 1c and ITA 4c	Saving and duplicating programs For IHP+ 1c/2c, IHP 1c 18 mm, IHP+ 1c 18 mm	
Mounting	–		Located on front face	
Catalogue numbers	CCT15860	CCT15950	CCT15861	CCT15955
Technical specifications				
Degree of protection	–		–	–
Operating temperature	–		–	–

Specific technical data

7

IHP+ 1c, IHP+ 2c	
Manual functions	Temporary cancellation of programming for holidays, public holidays, etc. by configuration of the 2 dates - start and end of absence Simulation of presence thanks to random operation during On periods
Pulse functions	Programming of pulses adjustable from 1 to 59 s (pulse takes priority over switching)
Back-lighting of the screen	
External input (only for IHP+ 1c, IHP+ 2c)	
External inputs for external control with a standard switch or a push-button	1 input for IHP+ 1c 2 inputs for IHP+ 2c
Voltage rating (Ue)	230 V AC, +10 %, -15 %
Frequency	50/60 Hz
Input current	≤ 1.2 mA
Consumption	≤ 0.3 mW
Cable length	≤ 100 m

Antenna		Additional jumpers
GPS antenna for ITA		IH jumpers
P140491		
Antenna for ITA 1c and ITA 4c		They are used to program a larger number of sequences for: <ul style="list-style-type: none"> ■ IH 24h 2c ARM (15337) ■ IH 24h + 7j 1+1c ARM (15366)
<ul style="list-style-type: none"> ■ 10 ITA maximum per antenna, maximum distance between the ITA and the antenna: 200 m ■ Outside the electrical switchboard, outdoors, under shelter 		1 bag containing: <ul style="list-style-type: none"> ■ 5 red ■ 5 green ■ 5 white ■ 5 yellow
CCT15970 ⁽¹⁾		15341
IP54		–
-30 °C to +55 °C		–

⁽¹⁾ external 12-30 V DC power supply needed

ITA 1c, ITA 4c	
Switching functions	On, Off, pulse, cycle, yearly program
Pulse length pulse function (switching time)	1 s to 59 min 59s
Pulse length timer (manual switching)	1 s to 9 h 59 min 59 s
Pulse/pause length cycle	1 s to 9 h 59 min 59 s
Minimum interval	1 min
External inputs (only for ITA 4c)	
External inputs for external control with a standard switch or a push-button	2 inputs : <ul style="list-style-type: none"> ■ Ext1 input: supplied with 230 V AC, ±10%- 50/60 Hz ■ Ext2 input Ext2: potential free
Antennas	GPS- ITA
Power supply	External 12 - 30 VDC
Output	DCF time telegraph (no weather data)
Receiver	–
Operation indicator	Flashing LED on receiving

Programming principle

- For the digital time switches, this consists of memorising the days and times of the required switching operations.
- For the mechanical time switches, this is performed by positioning captive segments or jumpers on a switching dial.

Example

- Controlling an air conditioner in a hairdressing salon:

	Monday ⁽¹⁾	Tuesday	Wednesday	Thursday ⁽²⁾	Etc.	
On n° 1		08 h 30	08 h 30	08 h 30		Switch on
Off n° 1		12 h 00	12 h 00			Switch off
On n° 2		13 h 30	13 h 30			Switch on
Off n° 2		20 h 00	20 h 00	20 h 00		Switch off

⁽¹⁾ Closed on Mondays

⁽²⁾ Non-stop

Programming by copying or blocks

Whenever identical switching operations are found at the same times, several days in the week, this function lets you program these operations once only. In this case a single switching operation is used. If this function is used wisely, the number of possible switching operations can be greatly increased.

Example

	Monday	Tuesday	Wednesday	Thursday	Friday	
On n°1	10 h 00			10 h 00		Switch on
Off n°1		18 h 00	18 h 00		18 h 00	Switch off

The diagram shows two horizontal arrows representing switching operations. The first arrow starts at Monday 10h00 and ends at Thursday 10h00, with a label '1 switching operation' below it. The second arrow starts at Tuesday 18h00 and ends at Friday 18h00, also with a label '1 switching operation' below it. Vertical arrows point from the start and end times of these blocks to the corresponding cells in the table above.

Number of switching operations

Designation	Number of switching operations
IHP 1c	56
IHP + 1c	84
IHP 2c	56
IHP + 2c	84
IHP 1c 18 mm	56
IHP + 1c 18 mm	84
ITA 1c, ITA 4c	300
IH 24h 1c ARM	48 On - 48 Off
IH 24h 1c SRM	48 On - 48 Off
IH 60mn 1c SRM	48 On - 48 Off
IH 24h 1c SRM	48 On - 48 Off
IH 24h 1c ARM	48 On - 48 Off
IH 24h 2c ARM	24 On - 24 Off
IH 7j 1c ARM	42 On - 42 Off
IH 24 h + 7j 1+1c ARM	16 On - 16 Off + 7 On - 7 Off

Saving on mains cut off

For digital switches equipped with this function, a lithium battery is used for saving. The program, date and time are preserved. Switching operations are not performed.

Lets you control starting and stopping of a group of loads according to a cycle that is repeated every 60 minutes.

60 min. time programming

Example

Controlling automatic watering	
On n° 1	2 min. 30 s
Off n° 1	5 min.
On n° 2	25 min.
Off n° 2	37 min. 30 s

Relevant time switches

IH 60mn 1c SRM.

Lets you control starting and stopping of one or two groups of loads according to a daily cycle that is repeated, in identical manner, every day of the week.

24 h daily programming

Example

- Controlling a door of a block of flats:
 - from 8 am to 7.30 pm: contact on "On", free access,
 - from 7.30 pm to 8 am the next day: contact on "Off", access by confidential code every day of the week:

From Monday to Sunday	
On n° 1	8 am
Off n° 1	7.30 pm

Relevant time switches

- IH 24h 1c SRM/ARM.
- IH 24h 2c ARM.
- IHP 1c 18 mm.
- IHP + 1c 18 mm.
- IHP 1c, IHP + 1c.
- IHP 2c, IHP + 2c.
- ITA 1c, ITA 4c.

Lets you control starting and stopping of one to 4 groups of loads according to a weekly cycle, that can be different each day, repeated each week.

7 days weekly programming

Example

- Controlling an air conditioner in a hairdressing salon:

	Monday	Tuesday	Wednesday	Thursday	Friday	Saturday	Sunday
On n° 1			09 h 00	09 h 00	09 h 00		
Off n° 1			12 h 00	12 h 00			
On n° 2			14 h 00	14 h 00			
Off n° 2			20 h 00	20 h 00	20 h 00		
On n° 3						8 h 30	8 h 30
Off n° 3						12 h 30	12 h 30
On n° 4						14 h 30	14 h 30
Off n° 4						21 h 00	21 h 00

Relevant time switches

- IH 7j 1c ARM.
- IHP 1c, IHP + 1c.
- IHP 2c, IHP + 2c.
- IHP 1c 18 mm.
- IHP + 1c 18 mm.
- ITA 1c, ITA 4c.

Lets you control by pulses (adjustable from 1 to 59 s) one to four groups of loads (pulse relays, bells, etc.).

Pulse programming

Example

- Automatic controlling of bells, lighting and distribution of food: bells sounding the resumption and finish of work (channel 1), lighting of premises (channel 2), feeding fish in the aquarium (channel 3):

	Monday	Tuesday	Wednesday	Thursday	Friday	Saturday	Sunday
Channel 1: bell (20 s pulse order)							
On	08 h 00	08 h 00	08 h 00	08 h 00	07 h 00	09 h 00	–
Duration	20 s	20 s	20 s	20 s	20 s	20 s	–
On	12 h 00	12 h 00	12 h 00	12 h 00	11 h 00	13 h 00	–
Duration	20 s	20 s	20 s	20 s	20 s	20 s	–
On	14 h 00	14 h 00	14 h 00	14 h 00	13 h 00	–	–
Duration	20 s	20 s	20 s	20 s	20 s	–	–
On	18 h 00	18 h 00	18 h 00	18 h 00	16 h 00	–	–
Duration	20 s	20 s	20 s	20 s	20 s	–	–
Channel 2: lighting (latched order)							
On	07 h 30	07 h 30	07 h 30	07 h 30	06 h 30	08 h 30	–
Off	18 h 30	18 h 30	18 h 30	18 h 30	17 h 00	13 h 30	–
Channel 3: aquarium (15 s pulse order)							
On	10 h 00	–	10 h 00	–	10 h 00	–	10 h 00
Duration	15 s	–	15 s	–	15 s	–	15 s

Programming

- Programming of a pulse takes up 2 memory spaces.
- Combination of the two order types (pulse and latched) is possible on the same channel.

Relevant time switches

- IHP + 1c.
- IHP + 1c 18 mm.
- IHP + 2c.
- ITA 1c, ITA 4c.

Programming special days.

Example

- Controlling lighting and heating in a school:
- basic programming: program lighting (channel 1) and heating (channel 2):

	Monday	Tuesday	Wednesday	Thursday	Friday	Saturday	Sunday
Channel 1: lighting							
On	07 h 00	07 h 00	07 h 00	07 h 00	07 h 00	–	–
Off	20 h 00	20 h 00	16 h 00	20 h 00	16 h 00	–	–
Channel 2: heating							
On	06 h 00	06 h 00	06 h 00	06 h 00	06 h 00	–	–
Off	18 h 00	18 h 00	12 h 00	18 h 00	12 h 00	–	–

- dated programming: periods of non-operation, school holidays, etc. Just memorise an Off at the start and another Off at the end of each period of absence:

		Holidays				
		Winter	Spring	Summer	Autumn	End of year
Channel 1: lighting						
Off	Date	20 feb.	17-apr	07-july	23 oct.	18 dec.
	Time	12 h 00	17 h 00	12 h 00	17 h 00	12 h 00
Off	Date	08-march	03-may	9 sept.	2 nov.	4 jan.
	Time	01 h 00	01 h 00	01 h 00	01 h 00	01 h 00
Channel 2: heating						
Off	Date	20 feb.	17-apr		23 oct.	18 dec.
	Time	12 h 00	17 h 00		17 h 00	12 h 00
Off	Date	08-march	03-may		2 nov.	4 jan.
	Time	01 h 00	01 h 00		01 h 00	01 h 00



Relevant time switches

- ITA 1c, ITA 4c.

Lets you create special programs for dated days.

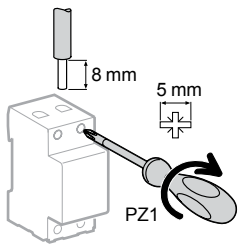
Connection



Type	Tightening torque	Copper cables	
		Rigid	Flexible or with ferrule
IHP 1c, 2c, +1c, +2c	2 screwless / pole		
IHP 18 mm 1c, +1c	2 screwless / pole	2 x 2.5 mm ²	2 x 2.5 mm ²
IH 60mn 1c SRM	2 screwless / pole	2 x 2.5 mm ²	2 x 2.5 mm ²
24h 1c SRM, ARM	2 screwless / pole	2 x 2.5 mm ²	2 x 2.5 mm ²
24h 2c ARM	1.2 N.m	≤ 6 mm ²	≤ 6 mm ²
7j 1c ARM	2 screwless / pole	2 x 2.5 mm ²	2 x 2.5 mm ²
24h + 7j 1+1c ARM	1.2 N.m	≤ 6 mm ²	≤ 6 mm ²
IH 18 mm 24h 1c SRM/ ARM	1.2 N.m	≤ 6 mm ²	≤ 6 mm ²
IHH 18 mm 7j 1c ARM	1.2 N.m	≤ 6 mm ²	≤ 6 mm ²
ITA 1c, ITA 4c	1.2 N.m	≤ 6 mm ²	≤ 6 mm ²

IHP 1c/2c, IHP+ 1c/2c are mechanical compatible with electrical distribution comb busbar.

Weight (g)

Time switches		
IHP	1c / 2c	170/ 205
IHP+	1c / 2c	190/ 211
IHP 18 mm	1c / +1c	90
IHP DCF		244
IH 54 mm	60mn 1c SRM	208
	24h 1c SRM/ARM	212 / 119
	24h 2c ARM	216
	7j 1c ARM	119
	24h + 7j 1+1c ARM	223
IH 18 mm	24h 1c SRM / ARM	97
IHH 18 mm	7j 1c ARM	101
ITA 1c		152
ITA 4c		303

Dimensions (mm)

IHP time switches

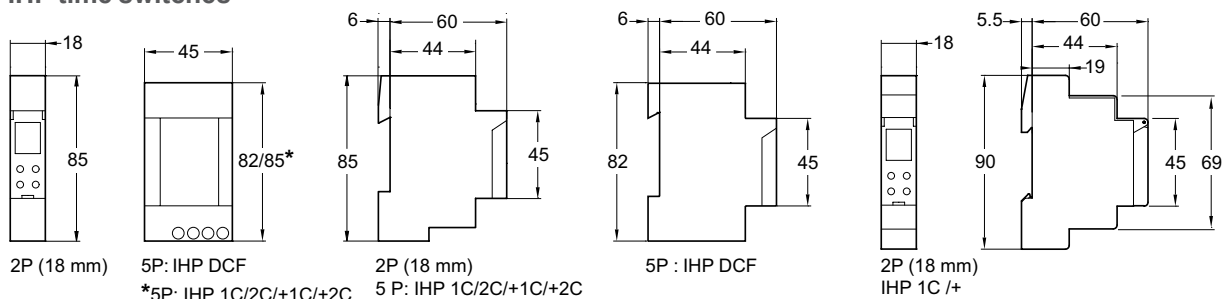

ANT DCF antenna

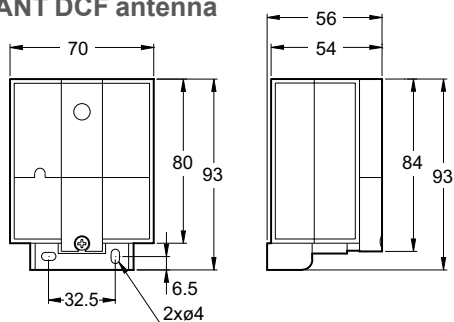

IH, IHH time switches

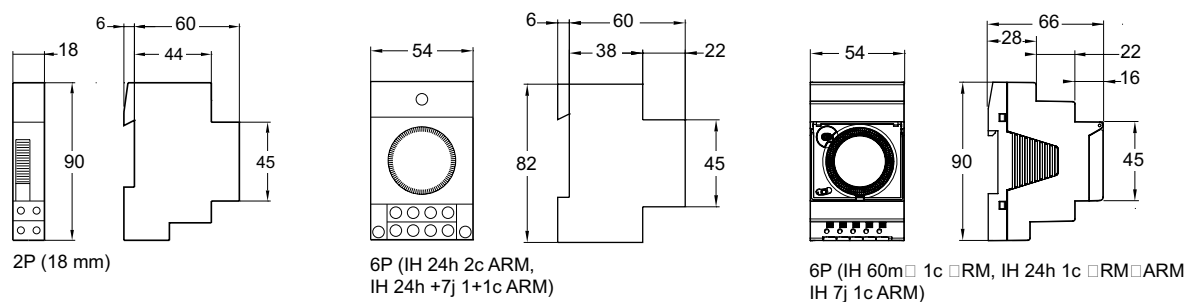

ITA yearly time switches

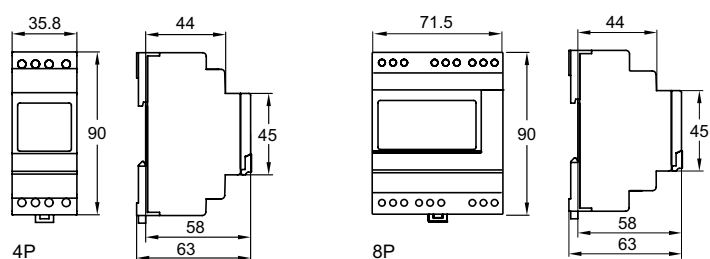

DCF antenna and GPS antenna for ITA

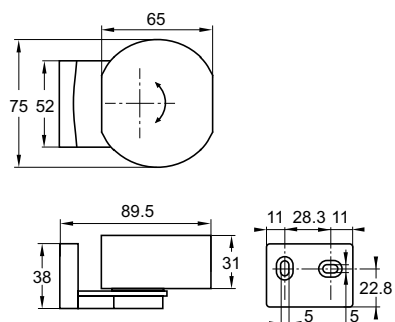

Twilight switches



IC100
Adjustable from 2 to 100 lux.
It comes with a wall-mounted cell.



IC2000
Adjustable from 2 to 2000 lux. It comes with a standard wall-mounted or switchboard cell.



IC2000P+
It has 3 customisable pre-set programs and 3 setting ranges from 2 to 2100 lux. Its 4 keys and large screen facilitate its programming.
It comes with a wall-mounted cell.





IC Astro
It operates without photoelectric cell and calculates sunrise and sunset times according to its geographic position.
It can be customised by using its programming function.



IC 100k
Adjustable from 2 to 99000 lux.
Its 4 keys and large screen facilitate its programming.
It comes with a digital wall-mounted or a switchboard cell.

Selection table

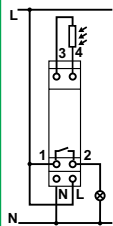
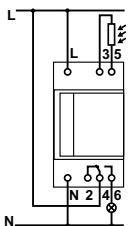
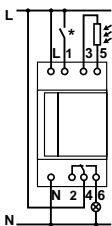
	IC100	IC2000	IC2000P+	
				
Function	The IC100 controls closing of a contact when brightness decreases and drops below the selected threshold. It controls opening of a contact when brightness increases and rises above the selected threshold	The IC2000 control closing of a contact when brightness decreases and drops below the selected threshold. They control opening of a contact when brightness increases and rises above the selected threshold	The IC2000P+ controls lighting according to brightness and time. If brightness drops below the set threshold (twilight function: IC) and if the time program allows relay closing (time switch function), then the lighting circuit is activated	
Wiring diagrams				
Catalogue numbers	15482	CCT15284	CCT15368	
			15483 ⁽¹⁾	
Technical specifications				
Delivered with	Wall-mounted cell	Switchboard cell (CCT15281)	Wall-mounted cell (CCT15268)	Wall-mounted cell
Optional accessories	Wall-mounted cell (CCT15268)	Switchboard cell (CCT15281) Wall-mounted cell (CCT15268)	Wall-mounted cell (CCT15268) Switchboard cell (CCT15281)	Wall-mounted cell (CCT15268)
Adjustable brightness threshold	2 to 100 lx	2 to 2000 lx		Range 1: 2 to 50 lx Range 2: 60 to 300 lx Range 3: 350 to 2100 lx
Voltage rating (Ue) (+10 %, -15 %)	230 V AC, 50/60 Hz	230 V AC, 50/60 Hz		230 V AC, 50/60 Hz
Consumption	6 VA	6 VA		3 VA
Operating temperature	-20°C to +50°C	-25°C to +50°C		-20°C to +50°C
Width (9 mm modules)	2	5		5
Insulation class	Class II	Class II		Class II
Degree of protection	IP20B	IP20B		IP20B
Output contact rating $\cos \varphi = 1$ (under 250 VAC)	16 A	16 A		16 A
	$\cos \varphi = 0.6$	10 A		10 A
Time delays (On and Off)	20 s (On) 80 s (Off)	≥ 60 s		Adjustable from 20 to 140 s (80 s by default)
Operating accuracy	-	-		$< \pm 1$ s / day at 20 °C.
Monitoring indicator light, not time delayed, lit when brightness is less than the threshold	Red	Red		-
Contact switching indicator light	Green	Green		-
LCD liquid crystal display	-	-		Back-lit
Program saving by lithium battery	-	-		■
Operating reserve	-	-		5-6 years
Location for instruction manual on front face	-	■		■
Cabling test function with a push-button on front face	-	■		-
Number of channels	1	1		1
Control by brightness detection	■	■		■
Coupling with weekly programming	-	-		42 switching times Minimum switching: 1 min Switching accuracy: 1 s
Control by calculation of sunrise/sunset times	-	-		-

Languages: (1) English, french, spanish, italian, german, portuguese, swedish, dutch, finnish, norwegian/danish. (2) English, french, spanish, portuguese, hungarian, polish romanian,

Twilight switches

IC100, 1C2000, IC2000P+, IC100k, and IC Astro (cont.)



The IC100kp+ 1C/2C control lighting according to brightness and time. If brightness drops below the set threshold (twilight function: IC) and if the time program allows relay closing (time switch function), then the lighting circuit is activated

The IC Astro astronomic programmable twilight switch is used to start and stop an electric load (e.g. lighting) according to sunrise and sunset times, without a brightness detector. Sunrise and sunset times are calculated automatically by the IC Astro according to the geographic parameters configured by the user

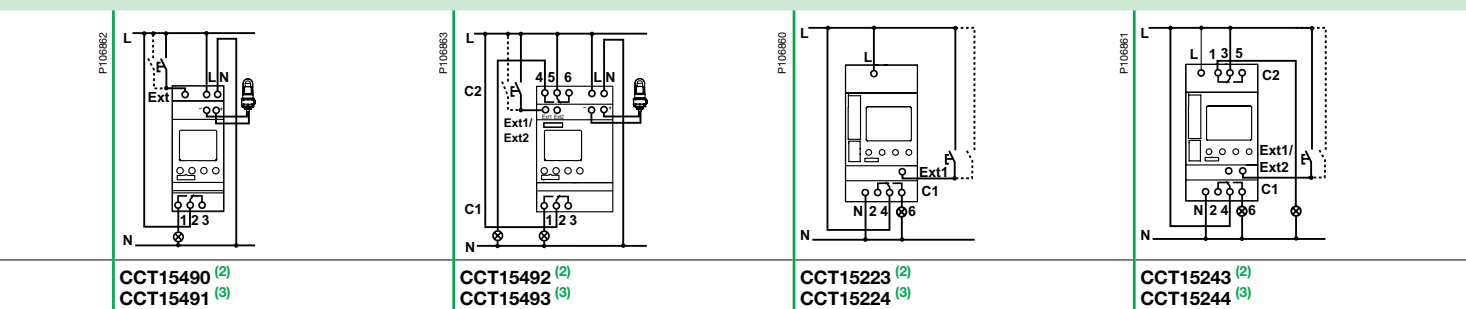

Digital wall-mounted cell (CCT15260) Memory key (alone) (CCT15861)	-	Memory key (alone) (CCT15861)
Digital wall-mounted cell (CCT15260) Digital switchboard cell (CCT15261) Programming kit for PC (CCT15860) Memory key (alone) (CCT15861)	Programming kit for PC (CCT15860) Memory key (alone) (CCT15861)	
1 to 99000 lx	According to sunrise/sunset times	
230 V AC, 50/60 Hz	100-240 V AC, 50/60 Hz	230 V AC, 50/60 Hz
3 VA		3 VA
-30°C to +50°C		-25°C to +45°C
4	6	5
Class II		Class II
IP20C		IP20B
16 A		16 A
10 A		10 A
Adjustable from 0 to 59.59 min.		Difference in sunset and/or sunrise times adjustable separately by ±120 min.
-		-
-		-
-		-
Back-lit		Back-lit
■		■
10 years		6 years
-		■
-		-
1	2	1
■		2
84 switching times Operating accuracy: < ±1 s / day at 20°C Minimum switching: 1 min Switching accuracy: 1 s		84 switching times (not including sunrise/sunset) Minimum time between 2 switching operations: 1 min. Switching accuracy: 1 s Time accuracy: ±1 s / day
-		■

7

czech, slovak, bulgarian, greek, slovene, serbian, croatian. (3) English, french, italian, german, swedish, dutch, finnish, danish, russian, ukrainian, latvian, lituanien, estonian.

Accessories selection table

	Wall-mounted cell		Switchboard cell	Programming kit for PC	Memory key	Digital wall-mounted cell	Digital switchboard cell
Function	Wall-mounted photoelectric cell		Switchboard photoelectric cell	Consists of a programming device, a memory key, a CDROM and a 2 m USB cable	Saving and duplicating programs	Digital wall-mounted photoelectric cell	Digital wall-mounted photoelectric cell
Mounting	<ul style="list-style-type: none"> Delivered with its fixing device for IC100 and IC200P+ Replaced by CCT15268 for spare part use Cell connection: by double insulation 2-conductor cable, not to be laid next to mains cables or water ducts, maximum length: 25 m 	Delivered with 1 m cable and its fixing device	<ul style="list-style-type: none"> Delivered with its fixing device Cell connection: by double insulation 2-conductor cable, not to be laid next to mains cables or water ducts, maximum length: 100 m 	–	–	<ul style="list-style-type: none"> Delivered with its fixing device. Cell connection: <ul style="list-style-type: none"> by double insulation 2-conductor cable: <ul style="list-style-type: none"> - 0.5 - 2.5 mm² for CCT15260 - 0.25 - 1.5 mm² for CCT15261 Not to be laid next to mains cables or water ducts, maximum length: <ul style="list-style-type: none"> - 100 m (2 x 1.5 mm²) - 50 m (2 x 0.75 mm²) 	
Catalogue no.	–	CCT15268	15281	CCT15860	CCT15861	CCT15260	CCT15261

Technical specifications

	IP54	IP65	IP54	–	–	IP55	IP66
Degree of protection	IK05	–	IK05	–	–	–	–
Operating temperature	-40°C to +70°C	-40°C to +70°C	-40°C to +70°C	–	–	-40°C to +70°C	-40°C to +70°C
Horizontally orientable	–	–	90°	–	–	90°	90°

Load table

Type of lighting (230 V AC)	Max. power (for higher power, relay with a contactor)				
	IC100	IC2000	IC2000P+	IC Astro	IC 100k
Incandescent and halogen lamps	2300 W	2300 W	2300 W	2300 W	2600 W
Non-corrected / serial-corrected / dual mounted fluorescent tubes with conventional ballast	2300 VA	2300 VA	26 x 36 W, 20 x 58 W, 10 x 100 W	26 x 36 W, 20 x 58 W, 10 x 100 W	26 x 36 W, 20 x 58 W, 10 x 100 W
Parallel corrected fluorescent tubes with conventional ballast	400 VA	400 VA	10 x 36 W, 6 x 58 W, 2 x 100 W	10 x 36 W, 6 x 58 W, 2 x 100 W	10 x 36 W, 6 x 58 W, 2 x 100 W
Fluorescent tubes with electronic ballast	–	–	9 x 36 W, 6 x 58 W	9 x 36 W, 6 x 58 W	650 VA max.
Dual-mounted fluorescent tubes with electronic ballast	300 VA	300 VA	5 x (2 x 36 W), 3 x (2 x 58 W)	5 x (2 x 36 W), 3 x (2 x 58 W)	–
Fluocompact lamps with electronic ballast	9 x 7 W, 7 x 11 W, 7 x 15 W, 7 x 20 W, 7 x 23 W	9 x 7 W, 7 x 11 W, 7 x 15 W, 7 x 20 W, 7 x 23 W	9 x 7 W, 7 x 11 W, 7 x 15 W, 7 x 20 W	9 x 7 W, 7 x 11 W, 7 x 15 W, 7 x 20 W	22 x 7 W, 18 x 11 W, 16 x 15 W, 16 x 20 W, 14 x 23 W
Fluocompact lamps with conventional ballast	1500 VA	1500 VA	–	–	–
Parallel-corrected mercury and sodium vapour lamps	400 VA	400 VA	250 VA	250 VA	800 VA max. (80uF)
Non-corrected/ serial-corrected mercury and sodium vapour lamps	1000 VA	1000 VA	–	–	–
Motor	–	–	–	–	2300 VA max.

Specific technical data

IC2000P+	
External input	
Voltage rating (Ue)	230 V AC, +10 %, -15 %
Frequency	50/60 Hz
Input current	≤ 2.5 mA
Consumption	≤ 0.4 mW
Cable length	≤ 100 m
IC Astro	
Programming longitude	-180° (East) to +180° (West) in steps of 1°
Programming latitude	-90° (South) to +90° (North) in steps of 1°
External inputs for external control with a standard switch or a push-button	<ul style="list-style-type: none"> ■ 1 input "Ext1" for IC Astro 1C ■ 2 inputs "Ext1" and "Ext2" for IC Astro 2C □ consumption: < 0.5 mA □ cable length: ≤ 100 m
Programming accessories	<ul style="list-style-type: none"> ■ Programming kit for PC consists of a programming device, a memory key, a CDROM and a 2 m USB cable ■ Memory key for saving and duplicating programs
IC 100k, IC Astro	
Programming accessories	<ul style="list-style-type: none"> ■ Programming kit for PC consists of a programming device, a memory key, a CDROM and a 2 m USB cable ■ Memory key for saving and duplicating programs
Memory key delivered on front face for IC100kp+ 1C, IC100kp+ 2C and IC Astro	
External inputs	
External inputs for external control with a standard switch or a push-button	<ul style="list-style-type: none"> ■ 1 input "Ext" for 1 channel versions ■ 2 inputs "Ext1" and "Ext2" for 2 channels versions
Voltage rating (Ue)	<ul style="list-style-type: none"> ■ 230 V AC, +10 %, -15 % for 1 channel versions ■ 100-240 V AC +10 %, -15 % for 2 channels versions
Frequency	50/60 Hz
Input current	≤ 0.5 mA
Consumption	≤ 130 mW
Cable length	≤ 100 m

Connection

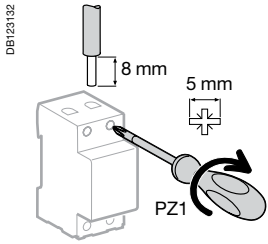

Type	Tightening torque	Copper cables	
		Rigid	Flexible or with ferrule
IC100, IC2000P+	1.2 N.m	≤ 6 mm ²	≤ 6 mm ²
IC2000, IC Astro, IC 100k	2 screwless / pole	2 x 2.5 mm ²	2 x 2.5 mm ²

IC100, IC Astro are mechanical compatible with electrical distribution comb busbar.

Weight (g)

Twilight switches	
IC100	173
IC2000	280
IC2000P+	323
IC Astro	132
IC 100k+/kp+ 1C / IC 100k+/kp+ 2C	183/ 352

Dimensions (mm)

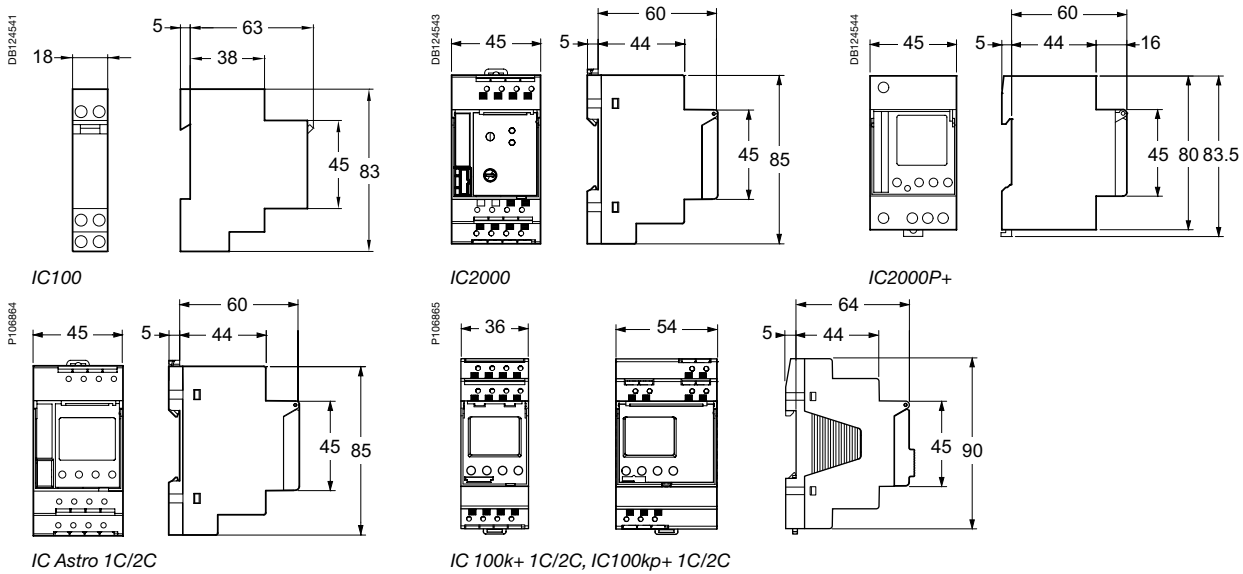

7

Cells

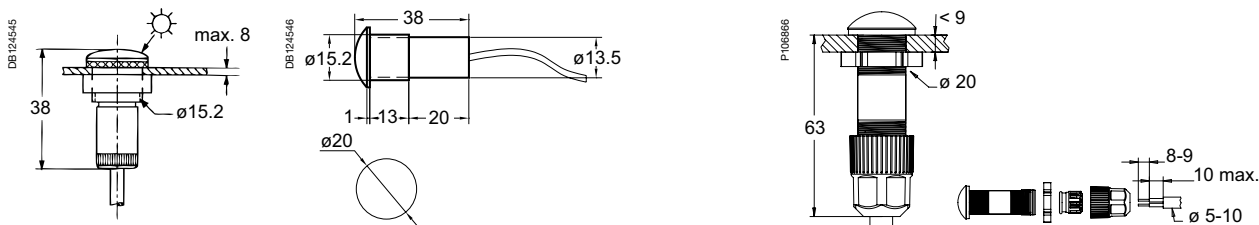

Standard switchboard cell (15281) Fixed externally in vertical position by 2 ø 4 mm screws

Digital switchboard cell (CCT15261)

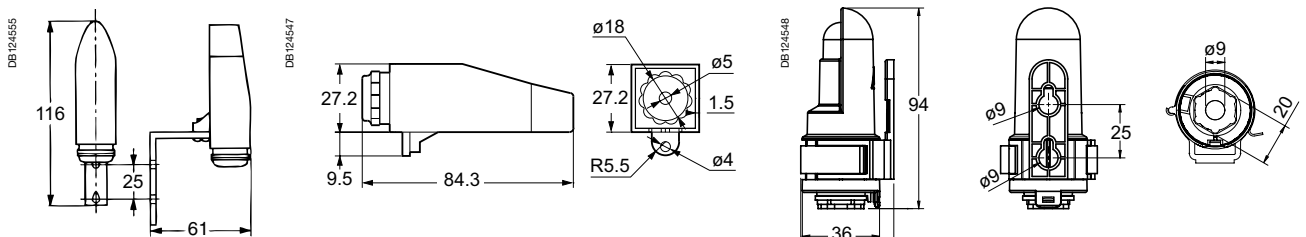

Wall-mounted cell (delivered with IC100, IC2000P+)

Standard and digital wall-mounted cell (CCT15268, CCT15260)



Application

The meters facilitate the real time monitoring of current, voltage and frequency.

Technical data

Supply voltage:	230Vac
Operating frequency:	50 - 60Hz
Display by red LED:	3 digits
Accuracy at full scale:	0.5% ± 1 digital
Consumption:	0.3VA
Connection:	Tunnel terminals for 2.5mm ² cables
EMC electromagnetic compatibility:	IEC EN 50081-1 and IEC EN 50082-2
Safety:	IEC EN 61010-1

Specific technical data

AMP 10A

Minimum value measured:	4% of rating
Measurement input consumption:	1VA

AMP Multirange

Ratings:	In direct reading: 5A By CT (not supplied) configurable on the front face of the ammeter: 10, 15, 20, 25, 40, 50, 60, 100, 150, 200, 250, 400, 500, 600, 800, 1000, 1500, 2000, 2500, 4000, 5000A
Minimum value measured:	4% of rating
Measurement input consumption:	0.55VA

VLT

Direct measurement:	0 - 600Vac
Input impedance:	2 MΩ
Minimum value measured:	4% of rating

FRE

Minimum value measured:	20Hz
Maximum value measured:	100Hz
Full scale display:	99.9Hz

Type	Scale	Connection with CT	Width in 18mm ways	Part number
Amp with direct connection				
	0 - 10A	Direct	2	15202
AMP with multirating				
	0 - 5000A	As per rating	2	15209
VLT				
	0 - 600V	As per rating	2	15201
FRE				
	20 - 100Hz	As per rating	2	15208

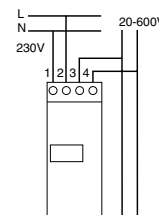
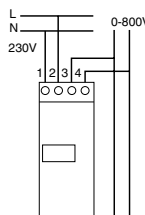
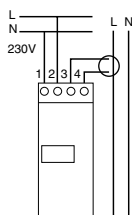



iEM2000T



iEM2000



iEM2010



iME1zr.

Function

Digital kilowatt-hour meters designed for sub-metering of active energy (rms) consumed by a single-phase or three-phase electric circuit with or without distributed neutral.

iEM2000T

40 A single-phase kilowatt-hour meter without display, with remote transfer of metering impulses (static output).

iEM2000

40 A single-phase kilowatt-hour meter.

iEM2010

40 A single-phase kilowatt-hour meter with remote transfer of metering impulses (static output).

iME1

Single-phase kilowatt-hour meter.

iME1z

Single-phase kilowatt-hour meter with partial meter.

iME1zr

Single-phase kilowatt-hour meter with partial meter and remote transfer of metering impulses (relay output).

Catalogue numbers

Type	Rating (A)	Voltage (V AC)	Tolerance (V AC)	Width in mod. of 9 mm	Cat. no.
Single-phase circuit (1L + N)					
iEM2000	40	230	±20	2	A9MEM2000
iEM2010	40	230	±20	2	A9MEM2010
iEM2000T	40	230	±20	2	A9MEM2000T
iME1	63	230	±20	4	A9M17065
iME1z	63	230	±20	4	A9M17066
iME1zr	63	230	±20	4	A9M17067

Main technical data

	iEM2000T	iEM2000/iEM2010	iME
Accuracy class	1	1	1
Frequency	48/62 Hz	48/62 Hz	48/62 Hz
Consumption	<10VA	<10VA	2.5 VA
Operating temp	-10°C to +55°C	-10°C to +55°C	-25°C to +55°C
Connection by tunnel terminals	Top terminals: 4 mm ² Bottom terminals: 10 mm ²	Top terminals: 4 mm ² Bottom terminals: 10 mm ²	Top terminals: 6 mm ² Bottom terminals: 16 mm ²
Compliance with standard	IEC 61557-12 : - PMD/DD/K55/1 IEC 62053-21 (accuracy)	IEC 61557-12 : - PMD/DD/K55/1 IEC 62053-21 (accuracy)	IEC 61557-12 : - PMD/DD/K55/1 IEC 62053-21 (accuracy)
Sealable screw shield	Yes	Yes	Yes
MID Compliance	No	Yes	No

Description

iEM2000, iEM2010, iEM2000T

- 1 Remote transfer pulse output (iEM2000T, iEM2010).
- 2 Green power-on indicator light.
- 3 Yellow metering indicator light (flashing).
- 4 Display unit (iEM2000, iEM2010).
- 5 Seal.
- 6 Allow the comb busbar to pass.

iME1, iME1z, iME1zr

- 1 Pulse output for remote transfer (iME1zr).
- 2 Flashing meter indicator.
- 3 Total or partial meter display (iME1z, iME1zr).
- 4 Wiring error indicator.
- 5 Push-button: total or partial meter display, reset partial meter (ME1z, ME1zr).
- 6 Sealing connection.

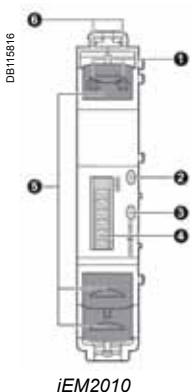

iEM2010

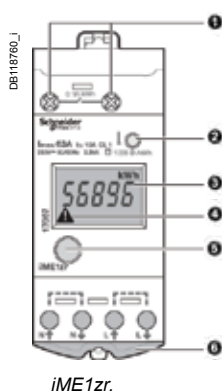

iME1zr.

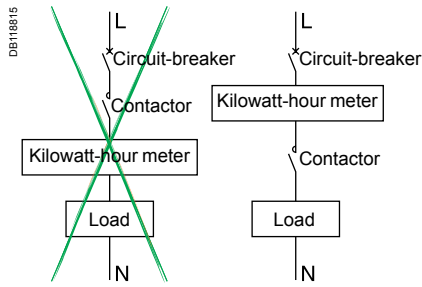

Example: meter on a load switching

Installation

- The front panel of the product is IP40 and its housing is IP20.
- Its installation must be appropriate to the operating conditions.
- The protection must not be less than IP65 for outdoor use.

Use with a contactor

A measurement instrument is normally continually supplied. For a non-continuous supply (load switching), we recommend that you place the breaking device downstream from the measurement instrument to limit disturbances on the module inputs. These disturbances, particularly on inductive loads, may result in early ageing of the device. You must also place the measurement instrument at a distance from the breaking device to limit the risk of disturbance.

Specific technical data

iEM2000, iEM2010, iEM2000T, iME1, iME1z and iME1zr specific technical data						
	iEM2000	iEM2010	iEM2000T	iME1	iME1z	iME1zr
Direct measurement	Up to 40 A			Up to 63 A		
Metering and activity indicator light (yellow)	3,200 flashes per kWh			1,000 flashes per kWh		
Wiring error indicator	Yes					
Total meter (max. capacity) on one phase	999 999.9 kWh			999.99 MWh		
Total meter display	In kWh with 7 significant digits (not for iEM2000T)			In kWh or MWh with 5 significant digits. No decimal point in kWh; 2 digits after the decimal point in MWh		
Partial meter (max. capacity) on one phase with RESET	-			-		
Partial meter display	-			99.99 MWh		
Remote transfer	-			-		By NO impulse contact: - ELV insulation voltage: 4 kV, 50 Hz - 18 mA/24 V DC, 100 mA/230 V AC - 1 impulse of 200 ms (contact closing) per kWh
	By static output: - ELV insulation voltage: 4 kV, 50 Hz - 20 mA/35 V DC max. - 100 impulses of 120 ms per kWh					

Connection

Single-phase circuit

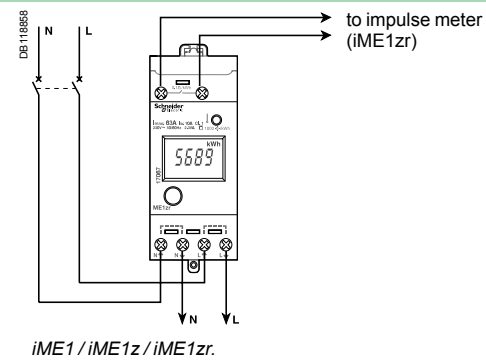
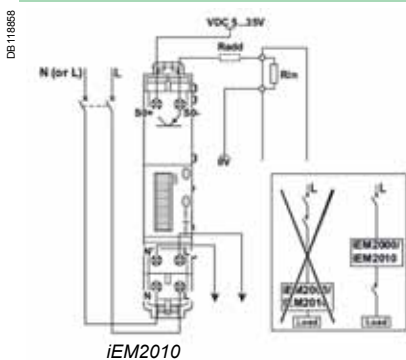

Caution

- Do not earth the CT secondary (S2).
- You must comply with the routing direction of power cables in the current transformer primary. Cables enter in "P1" and leave in "P2" to the loads.

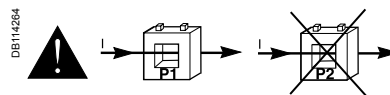
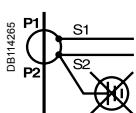

Kilowatt-hour meters

Energy Meter Series iEM3000 Functions and characteristics



Energy Meter Series iEM3100



Energy Meter Series iEM3255

The PowerLogic Energy meter Series iEM3000 offers a cost-attractive, competitive range of DIN rail-mounted energy meters ideal for sub-billing and cost allocation applications.

Combined with communication systems, like Smart Link, the iEM3000 series make it easy to integrate electrical distribution measurements into customer's facility management systems. It's the right energy meter at the right price for the right job.

Two versions are available: 63A direct measure (iEM3100) and current transformers associated meter (iEM3200). For each range five versions are available to satisfy from basic to advanced applications:

- iEM3100/iEM3200: kWh meter with partial counter
- iEM3110/iEM3210: kWh meter with partial counter and pulse output. MID certified.
- iEM3115/iEM3215: a multi-tariff meter controlled by digital input or internal clock, MID certified.
- iEM3150/iEM3250: kWh meter with partial counter and current, voltage, power measurement. Modbus communication.
- iEM3155/iEM3255: energy meter, four quadrant, multi-tariffs with partial counter and current, voltage, power measurement. Modbus communication, digital input/output and MID certified.

- Innovative design makes the meters smart and simple:
- Easy to install for panel builders
- Easy to commission for contractors and installers
- Easy to operate for end users

Applications

Cost management applications

- Bill verification
- Sub-billing, including WAGES view
- Cost allocation, including WAGES view

Network management applications

- Basic electrical parameters like current, voltage and power
- Onboard overload alarm to avoid circuit overload and trip
- Easy integration with PLC systems by input/output interface

Market segments

- Buildings & Industry
- Data centres and networks
- Infrastructure (airports, road tunnels, telecom)

Characteristics

- Self-powered meters
- Chain measurement (meters + CTs) accuracy class 1
- Compliance with IEC 61557-12, IEC 62053-21/22, IEC 62053-23, EN50470-3
- Graphical display for easy viewing
- Easy wiring (without CTs) iEM3100 series
- Double fixation on DIN rail (horizontal or vertical)
- Anti-tamper security features ensure the integrity of your data

Part numbers

Meter model and description	Current measurement	Part no.
iEM3100 basic energy meter	Direct connected 63 A	A9MEM3100
iEM3110 energy meter with pulse output	Direct connected 63 A	A9MEM3110
iEM3115 multi-tariff energy meter	Direct connected 63 A	A9MEM3115
iEM3150 energy meter & electrical parameter plus RS485 comm port	Direct connected 63 A	A9MEM3150
iEM3155 advanced multi-tariff energy meter & electrical parameter plus RS485 comm port	Direct connected 63 A	A9MEM3155
iEM3200 basic energy meter	Transformer connected 6 A	A9MEM3200
iEM3210 energy meter with pulse output	Transformer connected 6 A	A9MEM3210
iEM3215 multi-tariff energy meter	Transformer connected 6 A	A9MEM3215
iEM3250 energy meter & electrical parameter plus RS485 comm port	Transformer connected 6 A	A9MEM3250
iEM3255 advanced multi-tariff energy meter & electrical parameter plus RS485 comm port	Transformer connected 6 A	A9MEM3255

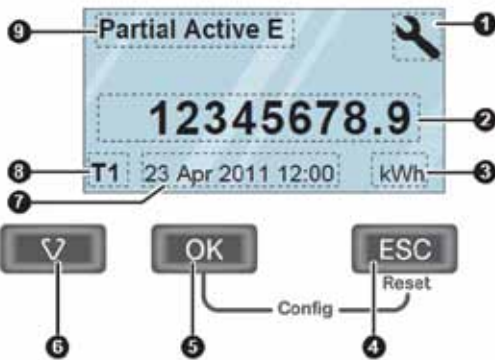

Front of meter parts

- 1 Configuration mode
- 2 Values and parameters
- 3 Unit
- 4 Cancellation
- 5 Confirmation
- 6 Selection
- 7 Date and time
- 8 Tariff currently used (iEM3255)
- 9 Functions/Measurements

Function guide	iEM3100	iEM3110	iEM3115	iEM3150	iEM3155	iEM3200	iEM3210	iEM3215	iEM3250	iEM3255
Direct measurement (up to 63 A)	■	■	■	■	■					
CTs inputs (1 A, 5A)						■	■	■	■	■
VTs inputs									■	■
Active energy measurements	■	■	■	■	■	■	■	■	■	■
Four quadrant energy measurements					■					■
Electrical measurements (I, V, P, etc.)				■	■				■	■
Multi-tariff (internal clock)			4		4			4		4
Multi-tariff (external control)			4		2			4		2
Measurement display	■	■	■	■	■	■	■	■	■	■
Programmable inputs					1					1
Programmable digital outputs					1					1
Pulse output		■					■			
kW overload alarm					■					■
Modbus RS485				■	■				■	■
MID (legal metrology certification)		■	■		■		■	■		■
Width (18 mm module in DIN Rail mounting)	5	5	5	5	5	5	5	5	5	5



Direct connected up to 63 A



CTs connected (1 A / 5 A)

Connectivity advantages

Programmable digital input	External tariff control signal (4 tariffs) Remote Reset partial counter External status, e.g. breaker status Collect WAGES pulses
Programmable digital output	kWh overload alarm (iEM3155/iEM5255) kWh pulses
Graphic LCD display	Scroll energies Current, voltage, power, frequency, power factor
Communication	Modbus RS485 with plug-in screw terminals allows connection to a daisy chain
Standards	
IEC standards integrated display	IEC 61557-12, IEC 61036, IEC 61010, IEC 62053-21/22 Class 1 and Class 0.5S, IEC 62053-23
MID	EN 50470-1/3

Multi-tariff capability

The iEM3000 range allows arrangement of kWh consumption in four different registers. This can be controlled by:

- Digital Inputs. Signal can be provided by PLC or utilities
- Internal clock programmable by HMI
- Through communication

This function allows users to:

- Make tenant metering for dual source applications to differentiate backup source or utility source
- Understand well the consumption during working time and non working time, and between working days and weekends
- Follow up feeders consumption in line with utility tariff rates

Specification guide	iEM3100 Range				
	iEM3100	iEM3110	iEM3115	iEM3150	iEM3155
Current (max.) Direct connected	63 A				
Meter constant LED	500/kWh				
Pulse output		Up to 1000p/kWh			Up to 1000p/kWh
Multi-tariff			4 tariffs		4 tariffs
Communication				Modbus via RS485	Modbus via RS485
DI/DO		0/1	2/0		1/1
MID (EN50470-3)		■	■		■
Network	1P+N, 3P, 3P+N				
Accuracy class	Class 1 (IEC 62053-21 and IEC61557-12) Class B (EN50470-3)				
Wiring capacity	16 mm ²				
Display max.	LCD 99999999.9kWh				
Voltage (L-L)	3 x 100/173 Vac to 3 x 277/480 Vac (50/60 Hz)				
IP protection	IP40 front panel and IP20 casing				
Temperature	-25°C to 55°C (K55)				
Product size	10 steps of 9mm				
Overvoltage and measurement	Category III, Degree of pollution 2				
kWh	■	■	■	■	■
kVARh					■
Active power				■	■
Reactive power					■
Currents and voltages				■	■
Overload alarm					■
Hour counter					■

Specification guide	iEM3200 Range				
	iEM3200	iEM3210	iEM3215	iEM3250	iEM3255
1 A / 5 A CTs (max current)	6 A				
Meter constant LED	5000/kWh				
Pulse output frequency		Up to 100p/kWh			Up to 100p/kWh
Multi-tariff			4 tariffs		4 tariffs
Communication				Modbus via RS485	Modbus via RS485
DI/DO		0/1	2/0		1/1
MID (EN50470-3)		■	■		■
Network	1P+N, 3P, 3P+N support CTs			1P+N, 3P, 3P+N support CTs & VTs	
Accuracy class	Class 0.5S (IEC 62053-22 and IEC61557-12) Class C (EN50470-3) ⁽¹⁾				
Wiring capacity	6 mm ² for currents and 4 mm ² for voltages				
Display max.	LCD 99999999.9kWh or 99999999.9MWh				
Voltage (L-L)	3 x 100/173 Vac to 3 x 277/480 Vac (50/60 Hz)				
IP protection	IP40 front panel and IP20 casing				
Temperature	-25°C to 55°C (K55)				
Product size	10 steps of 9mm				
Overvoltage & measurement	Category III, Degree of pollution 2				
kWh	■	■	■	■	■
kVARh					■
Active power				■	■
Reactive power					■
Currents and voltages				■	■
Overload alarm					■
Hour counter					■

(1) For 1 A CTs Class 1 (IEC6253-21 and IEC61557-12 Class B (EN50470-3))



Power Meter Series PM3200



Power Meter Series PM3255

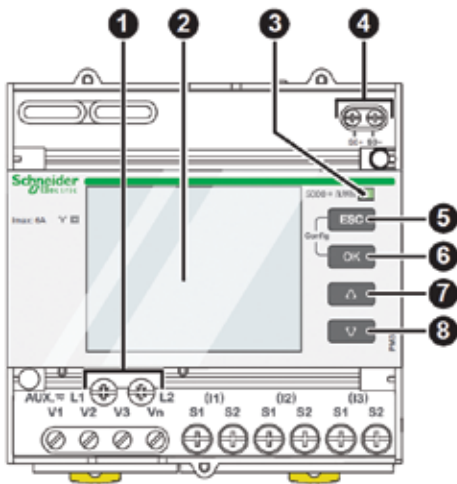

Front of meter parts

- 1 Control power
- 2 Display with white backlit
- 3 Flashing yellow meter indicator (to check accuracy)
- 4 Pulse output for remote transfer (PM3210)
- 5 ESC Cancellation
- 6 OK Confirmation
- 7 Up
- 8 Down

This PowerLogic Power meter offers basic to advanced measurement capabilities. With compact size and DIN rail mounting, the PM3200 allows mains and feeders monitoring in small electrical cabinets. Combined with current transformers and voltage transformers, these meters can monitor 2-, 3- and 4-wire systems. The graphic display has intuitive navigation to easily access important parameters.

Four versions are available offering basic to advanced applications:

- PM3200
 - Electrical parameters I, In, U, V, PQS, E, PF, Hz
 - Power/current demand
 - Min/max.
- PM3210
 - Electrical parameters I, In, U, V, PQS, E, PF, Hz, THD
 - Power/current demand, peak demand
 - Min/max.
 - 5 timestamped alarms
 - kWh pulse output
- PM3250
 - Electrical parameters I, In, U, V, PQS, E, PF, Hz, THD
 - Power/current demand, peak demand
 - Min/max.
 - 5 timestamped alarms
 - LED to indicate communications
 - RS485 port for Modbus communication
- PM3255
 - Electrical parameters I, In, U, V, PQS, E, PF, Hz, THD
 - Power/current demand and peak demand
 - Min/max. and 15 timestamped alarms
 - LED to indicate communications
 - Up to 4 tariffs management
 - 2 digital inputs, 2 digital outputs
 - Memory for load profile (demand 10mn to 60mn)
 - RS485 port for Modbus communication

- Innovative design makes the meters smart and simple:
- Easy to install for panel builders
- Easy to commission for contractors and installers
- Easy to operate for end users

Applications

Cost management applications

- Bill checking
- Sub-billing, including WAGES view
- Cost allocation, including WAGES view

Network management applications

- Panel instrumentation
- Up to 15 onboard timestamped alarms to monitor events
- Easy integration with PLC system by input/output interface

Market segments

- Buildings
- Industry
- Data centres and networks

Meter model and description	Performance	Part no.
PM3200 basic power meter	Basic power meter	METSEPM3200
PM3210 power meter with pulse output	Power, current, THD, peak demand	METSEPM3210
PM3250 power meter with RS485 port	Power, current, THD, peak demand	METSEPM3250
PM3255 power meter plus 2 digital inputs, 2 digital outputs with RS485 port	Power, current, THD, peak demand, memory for load profile	METSEPM3255



Function guide	PM3200 Range			
	PM3200	PM3210	PM3250	PM3255
Performance standard				
IEC61557-12 PMD/Sx/K55/0.5	■	■	■	■
General				
Use on LV and HV systems	■	■	■	■
Number of samples per cycle	32	32	32	32
CT input 1A/5A	■	■	■	■
VT input	■	■	■	■
Multi-tariff	4	4	4	4
Multi-lingual backlit display	■	■	■	■
Instantaneous rms values				
Current, voltage	Per phase and average		■	■
Active, reactive, apparent power	Total and per phase		■	■
Power factor	Total and per phase		■	■
Energy values				
Active, reactive and apparent energy; import and export	■	■	■	■
Demand value				
Current, power (active, reactive, apparent) demand; present	■	■	■	■
Current, power (active, reactive, apparent) demand; peak		■	■	■
Power quality measurements				
THD Current and voltage		■	■	■
Data recording				
Min/max of the instantaneous values	■	■	■	■
Power demand logs				■
Energy consumption log (day, week, month)				■
Alarms with time stamping		5	5	15
Digital inputs/digital outputs		0/1		2/2
Communication				
RS-485 port			■	■
Modbus protocol			■	■

7



Power Meter Series PM3210

Connectivity advantages	
Programmable digital input	External tariff control signal (4 tariffs) Remote Reset partial counter External status like breaker status Collect WAGES pulses
Programmable digital output	Alarm (PM3255) kWh pulses
Graphic LCD display	Backlit graphic display allows smart navigation in relevant information and in multi languages
Communication	Modbus RS485 with screw terminals allows connection to a daisy chain

Specifications	PM3200 Range
Type of measurement	True rms up to the 15th harmonic on three-phase (3P,3P+N) and single-phase AC systems. 32 samples per cycle
Measurement accuracy	
Current with x/5A CTs	0.3% from 0.5A to 6A
Current with x/1A CTs	0.5% from 0.1A to 1.2A
Voltage	0.3% from 50V to 330V (Ph-N), from 80V to 570V (Ph-Ph)
Power factor	±0.005 from 0.5A to 6A with x/5A CTs; from 0.1A to 1.2A with x/1A CTs and from 0.5L to 0.8C
Active/Apparent Power with x/5A CTs	Class 0.5
Active/Apparent Power with x/1A CTs	Class 1
Reactive power	Class 2
Frequency	0.05% from 45 to 65Hz
Active energy with x/5A CTs	IEC62053-22 Class 0.5s
Active energy with x/1A CTs	IEC62053-21 Class 1
Reactive energy	IEC62053-23 Class 2
Data update rate	
Update rate	1s
Input-voltage characteristics	
Measured voltage	50V to 330V AC (direct / VT secondary Ph-N) 80V to 570V AC (direct / VT secondary Ph-Ph) up to 1MV AC (with external VT)
Frequency range	45Hz to 65Hz
Input-current characteristics	
CT primary	Adjustable from 1A to 32767A
CT secondary	1A or 5A
Measurement input range with x/5A CTs	0.05A to 6A
Measurement input range with x/1A CTs	0.02A to 1.2A
Permissible overload	10A continuous, 20A for 10s/hour
Control Power	
AC	100/173 to 277/480V AC (+/-20%), 3W/5VA; 45Hz to 65Hz
DC	100 to 300V DC, 3W
Input	
Digital inputs (PM3255)	11 to 40V DC, 24V DC nominal, ≤4mA maximum burden, 3.5kVrms insulation
Output	
Digital output (PM3210)	Optocoupler, polarity sensitive, 5 to 30V, 15mA max, 3.5kVrms insulation
Digital outputs (PM3255)	Solid state relay, polarity insensitive, 5 to 40V, 50mA max, 50Ω max, 3.5kVrms insulation

Specifications (continued)	PM3200 Range
Mechanical characteristics	
Weight	0.26kg
IP degree of protection (IEC60529)	IP40 front panel, IP20 meter body
Dimension	90 x 95 x 70mm
Environmental conditions	
Operating temperature	-25 °C to +55 °C
Storage temperature	-40 °C to +85 °C
Humidity rating	5 to 95% RH at 50°C (non-condensing)
Pollution degree	2
Metering category	III, for distribution systems up to 277/480VAC
Dielectric withstand	As per IEC61010-1, Doubled insulated front panel display
Altitude	3000m max
Electromagnetic compatibility	
Electrostatic discharge	Level IV (IEC61000-4-2)
Immunity to radiated fields	Level III (IEC61000-4-3)
Immunity to fast transients	Level IV (IEC61000-4-4)
Immunity to surge	Level IV (IEC61000-4-5)
Conducted immunity	Level III (IEC61000-4-6)
Immunity to power frequency magnetic fields	0.5mT (IEC61000-4-8)
Conducted and radiated emissions	Class B (EN55022)
Safety	
	CE as per IEC61010-1 ⁽¹⁾
Communication	
RS485 port	Half duplex, from 9600 up to 38400 bauds, Modbus RTU (double insulation)
Display characteristics	
Dimensions (VA)	43mm x 34.6mm
Display resolution	128 x 96 dots
Standard compliance	
	IEC61557-12, EN61557-12 IEC61010-1, UL61010-1 IEC62052-11, IEC62053-21, IEC62053-22, IEC62053-23 EN50470-1, EN50470-3

(1) Protected throughout by double insulation

7



Power Meter Series PM3250

Multi-tariff capability

The PM3200 range allows arrangement of kWh consumption in four different registers. This can be controlled by:

- Digital Inputs. Signal can be provided by PLC or utilities
- Internal clock programmable by HMI
- Through communication

This function allows users to:

- Make tenant metering for dual source applications to differentiate backup source or utility source
- Understand well the consumption during working time and non working time, and between working days and weekends
- Follow up feeders consumption in line with utility tariff rates

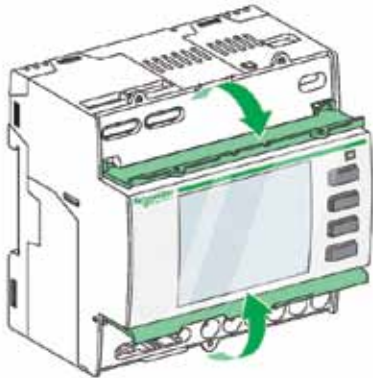

PM3200 top and lower flaps

PM3200 series dimensions

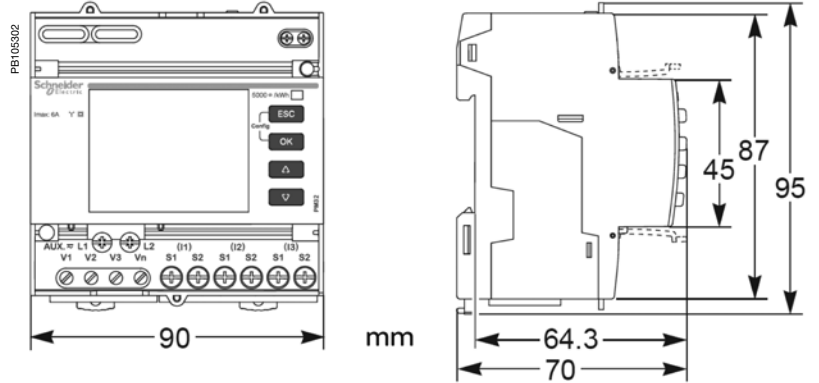

PM3200 series easy installation

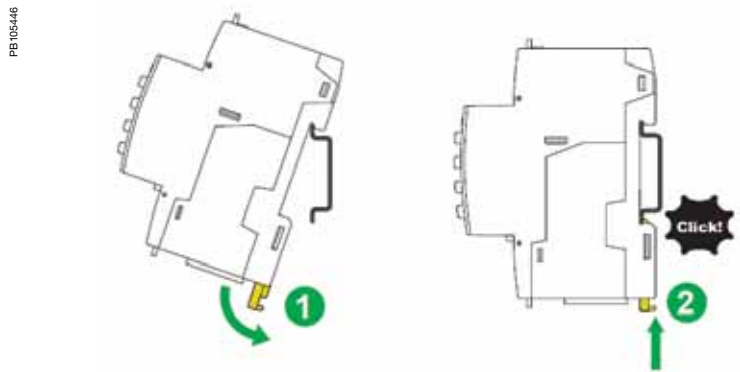

Digital Output and Digital Input sample wiring diagrams

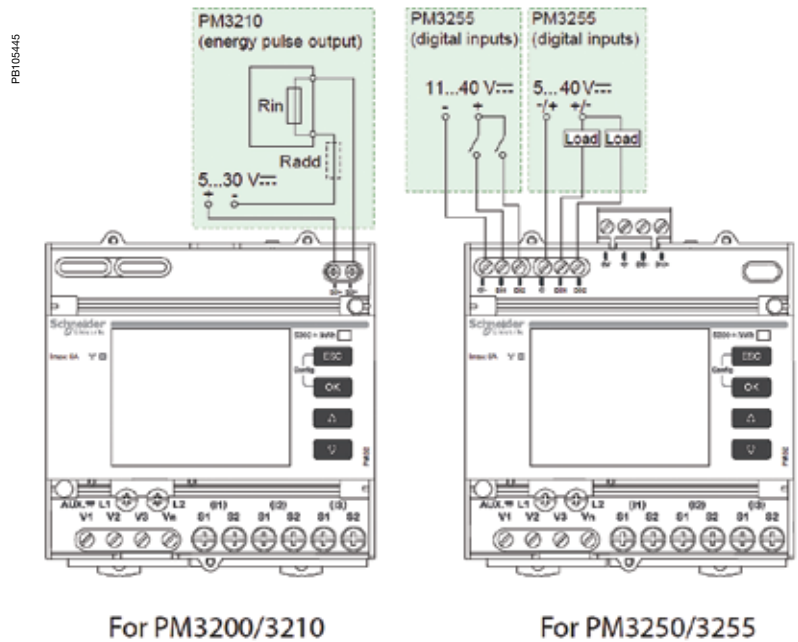

Note: These are sample wiring diagrams only. For further information please see the Instruction Sheet and User Guide documents for these products.

Note: These are sample wiring diagrams only. For further information please see the Instruction Sheet and User Guide documents for these products.

Modbus communications wiring diagram

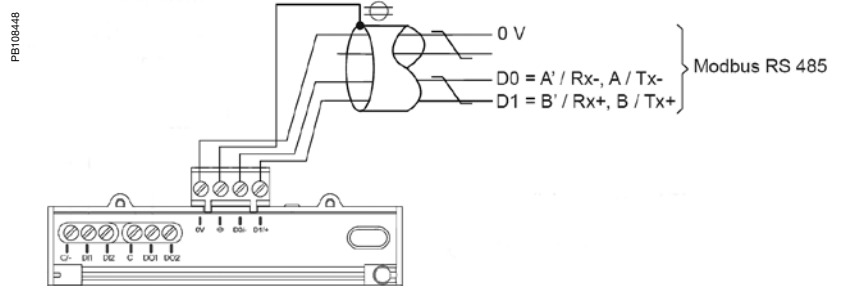

PM32xx series sample wiring diagrams - 1 phase

- 1 Protection (to be adapted to suit the short-circuit current at the connection point)
- 2 Shorting switch unit

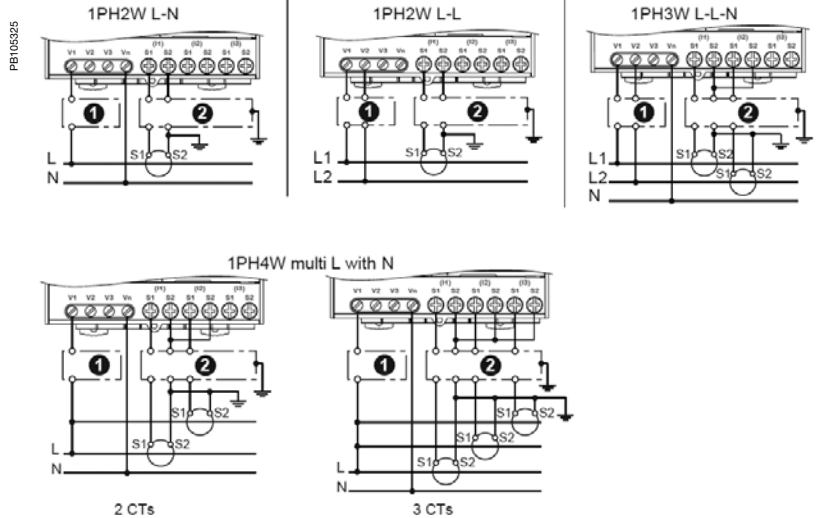

7

Note: These are sample wiring diagrams only. For further information please see the Instruction Sheet and User Guide documents for these products.

PM32xx Series sample wiring diagrams - 3 phase without VTs

- 1 Protection (to be adapted to suit the short-circuit current at the connection point)
- 2 Shorting switch unit

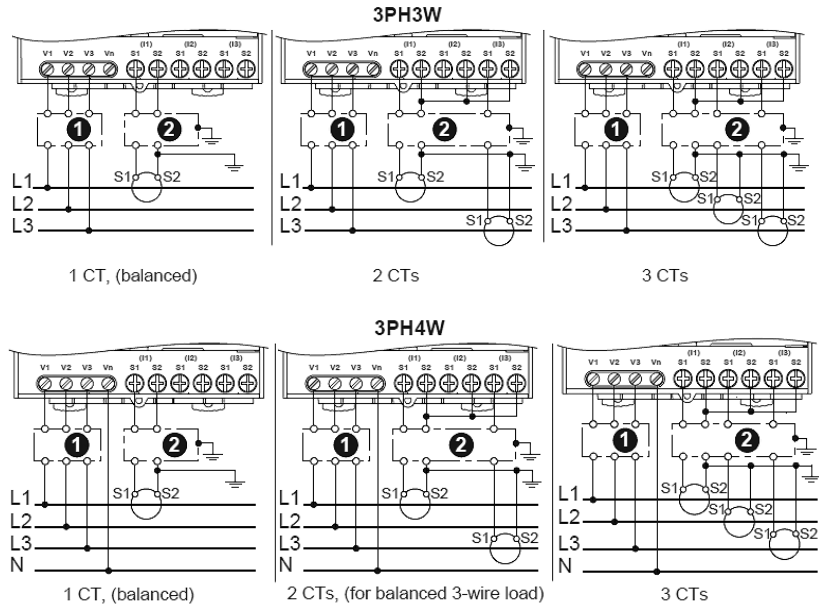

PM32xx Series sample wiring diagrams - 3 phase with VTs

Note: These are sample diagrams only. For further information please see the Instruction Sheet and User Guide documents for these products.

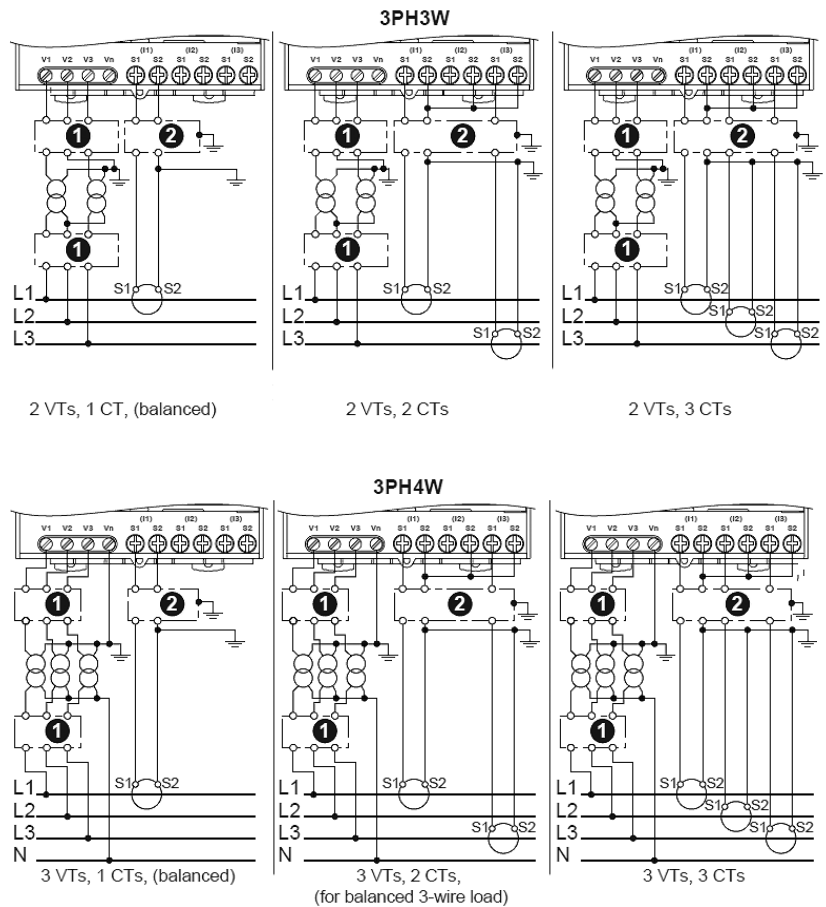

Current transformers

CT, Ip/5 A ratio

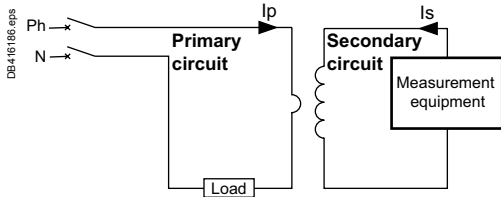

Application diagram of a CT.

The Ip/5A ratio current transformer delivers at the secondary a current (Is) of 0 to 5 A that is proportional to the current measured at the primary (Ip).

This allows them to be used in combination with measurement equipment:

- ammeters
- kilowatt-hour meters
- measurement units
- control relays
- etc.

When the primary is energized, the measurement equipment nearly acts as a short circuit which keeps the secondary voltage very low. This voltage will increase significantly if the short circuit is removed.

CT selection - conductor rating aspects

The choice depends on the conductor profile and the maximum intensity of the primary circuit.

CT with let-through primary					
Conductor type	Cable	Mixed, bars or cables	Vertical or horizontal bars	Vertical bars	
Suggested Current Transformer and mounting		 	 		
Ratings (A)	40 to 250	150 to 800	200 to 4000	500 to 600	5000 to 6000
CT internal profile	Type C	Type M	Type D ⁽¹⁾	Type V	

(1) Two secondary connectors (parallel internal wiring - only one secondary winding) for easier cable access. 1 lateral + 1 on one extremity. Warning: only one must be used at a time.

Specific mounting: use of cylinder

A cylindrical metallic spacer ensures a proper CT positioning when the conductor or the CT cannot be positioned perpendicular. Secured by bolt + nut.

CT with primary connection by screw and nut (example: use of cylinder with bar or cable)

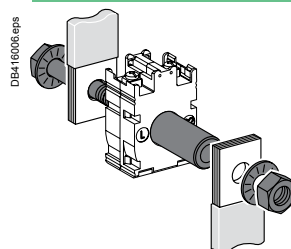

16550 (brass)

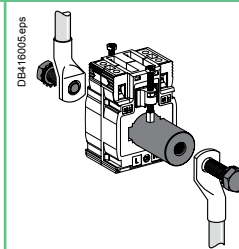

METSECT5CYL1 (aluminium)

CT selection - Electrical aspect Ip/5 A

- We recommend that you choose the ratio immediately higher than the maximum measured current (In).

Example:
In = 1103 A; ratio chosen = 1250/5.

- For small ratings:
from 40/5 to 75/5 and for an application with digital devices, we recommend that you choose a higher rating, for example 100/5.

This is because small ratings are less accurate and the 40 A measurement, for example, will be more accurate with a 100/5 CT than with a 40/5 CT.

- Specific case of the motor starter:
to measure motor starter current, you must choose a CT with primary current $I_p = I_d/2$ (I_d = motor starting current).

Validation of measurement solution according accuracy class

It consists in controlling the right adaptation of the CT on the accuracy class aspect. The accuracy class is specified in the project. The total dissipated power of the measurement circuit (meter + cables) should not be superior to the specified limit of the CT. This limit is for different standard classes. If necessary, the choice of the cable section, the CT or meter should be modified to fit the requirement.

Copper cable cross-section (mm ²)	Power per doubled meter at 20 °C (VA)	Schneider Electric device	Consumption of the current input (VA)
1	1	Ammeter 72 x 72 / 96 x 96	1.1
1.5	0.685	Analogue ammeter	1.1
2.5	0.41	Digital ammeter	0.3
4	0.254	PM700, PM800	0.15
6	0.169	PM3000	0.3
10	0.0975		
16	0.062		

For each temperature variation per 10 °C bracket, the power drawn up by the cables increases by 4 %.

Application example

Project specification: 200 A, in Ø27 mm cable, accuracy class 1.
Our choice is **METSECT5MA020**.

For this CT selected on the chart (next page), the max acceptable power is 7 VA (for "Accuracy class 1" which is specified in the project).

Internal profile type	Cables (mm)	Bars (mm)	Rating Ip/5 A (A)	Cat. no.	Accuracy class		
					0.5	1	3
					Max. power (VA)		
MA 	Ø27	10 x 32 15 x 25	150	METSECT5MA015	3	4	-
			200	METSECT5MA020	4	7	-
			250	METSECT5MA025	6	8	-
			300	METSECT5MA030	8	10	-
			400	METSECT5MA040	10	12	-

Control of the conformity of the measurement chain:

- PM3000 multi-meter: 0.3 VA.
- 4 meters of 2.5 mm², doubled wires: 0.41 x 4 = 1.64 VA.

Total: 0.3 + 1.64 = 1.94 VA (< 7 VA)

Conclusion: this CT is well adapted as the accuracy class will be even better than 1.



Presentation of catalogue numbers

MET SE CT **R** **FF** **XXX**

First digit = secondary rating,
R = 5 Amps

Last 3 digits = primary rating/10
2 letters = Form Factor





Examples:

- METSECT5CC008 = 5 A secondary, Cables only, 75 A primary
- METSECT5MC080 = 5 A secondary, Mixed for cables and bars, 800 A primary.

Type C - current transformer (cable profile)

Internal profile type	Cables (mm)	Bars (mm)	Rating Ip/5 A (A)	Cat. no.
	Ø21	-	40	METSECT5CC004
			50	METSECT5CC005
			60	METSECT5CC006
			75	METSECT5CC008
			100	METSECT5CC010
			125	METSECT5CC013
			150	METSECT5CC015
			200	METSECT5CC020
			250	METSECT5CC025

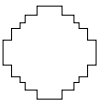
Type M - current transformers (mixed: cable/bar profile)

ME				
	Ø22	10 x 30 11 x 25 12 x 20	150	METSECT5ME015
			200	METSECT5ME020
			250	METSECT5ME025
			300	METSECT5ME030
			400	METSECT5ME040
			500	METSECT5ME050
600	METSECT5ME060			
MB				
	Ø26	12 x 40 15 x 32	250	METSECT5MB025
			300	METSECT5MB030
			400	METSECT5MB040
MA				
	Ø27	10 x 32 15 x 25	150	METSECT5MA015
			200	METSECT5MA020
			250	METSECT5MA025
			300	METSECT5MA030
			400	METSECT5MA040
MC				
	Ø32	10 x 40 20 x 32 25 x 25	250	METSECT5MC025
			300	METSECT5MC030
			400	METSECT5MC040
			500	METSECT5MC050
			600	METSECT5MC060
			800	METSECT5MC080
MF				
	Ø35	10 x 40	250	METSECT5MF025
			300	METSECT5MF030
			400	METSECT5MF040
			500	METSECT5MF050
MD				
	Ø40	12 x 50 20 x 40	500	METSECT5MD050
			600	METSECT5MD060
			800	METSECT5MD080

PB112446.eps



METSECT5CC●●●

PB112464.eps



METSECT5ME●●●

PB112461.eps



METSECT5MB●●●

PB112460.eps



METSECT5MA●●●

PB112462.eps



METSECT5MC●●●

PB112465.eps



METSECT5MF●●●

PB112463.eps



METSECT5MD●●●

Current transformers

CT, Ip/5 A ratio (cont.) Catalogue numbers

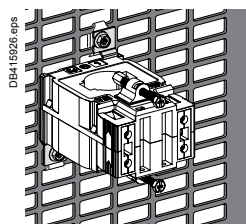

Mounting plate installation.

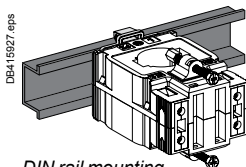

DIN rail mounting.

Common characteristics

Secondary current Is (A)	5
Maximum voltage rating Ue (V)	720
Frequency (Hz)	50/60
Safety factor (sf)	<ul style="list-style-type: none"> ■ 40 to 4000 A: sf ≤ 5 ■ 5000 to 6000 A: sf ≤ 10
Degree of protection	IP20
Operating temperature	<ul style="list-style-type: none"> ■ tropicalised range ■ -25 °C to +60 °C ⁽¹⁾ ■ relative humidity > 95 %
Compliance with standards	<ul style="list-style-type: none"> ■ IEC 61869-2 ■ VDE 0414
Secondary connection (as per model)	<ul style="list-style-type: none"> ■ by terminals for lug ■ by tunnel terminals ■ by screws

(1) Warning: some products are limited to +50 °C.

Accuracy class			Dimensions W x H x D (mm)	Fastening mode	Accessories Cylinder	Sealable cover
0.5	1	3				
Max. power (VA)						
-	-	1	44 x 65 x 30	<ul style="list-style-type: none"> ■ Adapter for DIN rails. ■ Mounting plate. 	16550 METSECT5CYL1	Included
-	1.25	1.5				
-	1.25	2				
-	1.5	2.5				
2	2.5	3.5				
2.5	3.5	4				
3	4	5				
4	5.5	6				
5	6	7				
1.5	5.5	6.5	56 x 84 x 42 Option, DIN rail mounting: 60.5 x 88.5 x 46.5	<ul style="list-style-type: none"> ■ Adapter for DIN rails. ■ Mounting plate. ■ Insulated locking screw. 	16551	16552
4	7	8.5				
6	9	11				
7.5	11	14				
10.5	15	18				
12	18	22				
14.5	21.5	26				
3	4	-	60 x 85 x 43 Option: 60 x 87 x 60	<ul style="list-style-type: none"> ■ Adapter for DIN rails. ■ Mounting plate. 	-	METSECT5COVER
4	6	-				
6	8	-				
3	4	-	56 x 80 x 43 Option: 56 x 82 x 60	<ul style="list-style-type: none"> ■ Adapter for DIN rails. ■ Mounting plate. 	METSECT5CYL2	METSECT5COVER
4	7	-				
6	8	-				
8	10	-				
10	12	-				
3	5	-	70 x 95 x 45 Option: 70 x 97 x 60	<ul style="list-style-type: none"> ■ Adapter for DIN rails. ■ Mounting plate. 	-	METSECT5COVER
5	8	-				
8	10	-				
10	12	-				
12	15	-				
10	12	-				
2.5	5	8	77 x 107 x 46 Option, DIN rail mounting: 82 x 113 x 51	<ul style="list-style-type: none"> ■ Adapter for DIN rails. ■ Mounting plate. ■ Insulated locking screw. 	-	16553
4	8	12				
8	12	15				
10	12	15				
4	6	-	70 x 95 x 45 Option: 70 x 97 x 60	<ul style="list-style-type: none"> ■ Adapter for DIN rails. ■ Mounting plate. 	-	METSECT5COVER
6	8	-				
8	12	-				



Type V current transformers (vertical bar profile)

Internal profile type	Cables (mm)	Bars (mm)	Rating Ip/5 A (A)	Cat. no.
VF	-	11 x 64 31 x 51	500	METSECT5VF050
			600	METSECT5VF060
VV	-	55 x 165	5000	METSECT5VV500 *
			6000	METSECT5VV600 *

Type D - current transformers (vertical or horizontal bar - dual secondary terminals)

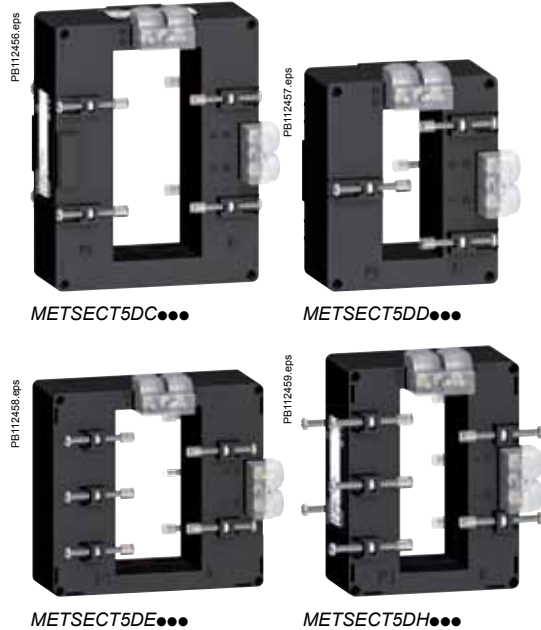

Internal profile type	Cables (mm)	Bars (mm)	Rating Ip/5 A (A)	Cat. no.
DA	-	32 x 65	200	METSECT5DA020
			250	METSECT5DA025
			300	METSECT5DA030
			400	METSECT5DA040
			500	METSECT5DA050
			600	METSECT5DA060
			800	METSECT5DA080
			1000	METSECT5DA100
DB	-	38 x 127	1000	METSECT5DB100
			1250	METSECT5DB125 *
			1500	METSECT5DB150 *
			2000	METSECT5DB200 *
			2500	METSECT5DB250 *
			3000	METSECT5DB300 *
DC	-	52 x 127	2000	METSECT5DC200 *
			2500	METSECT5DC250 *
			3000	METSECT5DC300 *
			4000	METSECT5DC400 *
DD	-	34 x 84	1000	METSECT5DD100
			1250	METSECT5DD125 *
			1500	METSECT5DD150 *
DE	-	54 x 102	1000	METSECT5DE100
			1250	METSECT5DE125 *
			1500	METSECT5DE150 *
			2000	METSECT5DE200 *
DH	-	38 x 102	1250	METSECT5DH125 *
			1500	METSECT5DH150 *
			2000	METSECT5DH200 *

* Operating temperature: -25 °C to +50 °C.



Current transformers

CT, Ip/5 A ratio (cont.) Catalogue numbers

Accuracy class			Dimensions W x H x D (mm)	Fastening mode	Accessories Cylinder 	Sealable cover 
0.5	1	3				
Max. power (VA)						
2	4	-	90 x 113 x 48	<ul style="list-style-type: none"> ■ Mounting plate. ■ Insulated locking screw. 	-	Included
4	6	-				
60	-	-	177 x 242 x 110	<ul style="list-style-type: none"> ■ Insulated locking screw. 	-	Included
70	-	-				
-	2	5	90 x 94 x 90	<ul style="list-style-type: none"> ■ Insulated locking screw. 	-	Included
1	4	-				
1.5	6	-				
4	8	-				
8	10	-				
8	12	-				
12	15	-				
15	20	-				
15	20	-				
20	25	-				
6	10	-	99 x 160 x 58	<ul style="list-style-type: none"> ■ Insulated locking screw. 	-	Included
8	12	-				
10	15	-				
15	20	-				
20	25	-				
25	30	-				
25	30	-	125 x 160 x 40	<ul style="list-style-type: none"> ■ Insulated locking screw. 	-	Included
30	50	-				
30	50	-				
30	50	-				
10	15	-	96 x 116 x 58	<ul style="list-style-type: none"> ■ Insulated locking screw. 	-	Included
12	15	-				
15	20	-				
12	15	-	135 x 129 x 50	<ul style="list-style-type: none"> ■ Insulated locking screw. 	-	Included
15	20	-				
20	25	-				
20	25	-				
12	15	-	98 x 129 x 40	<ul style="list-style-type: none"> ■ Insulated locking screw. 	-	Included
12	15	-				
20	25	-				

CT current transformers

CC internal profile type

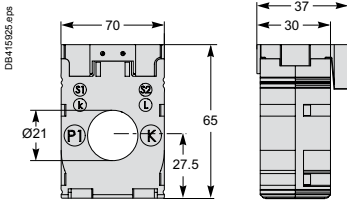

ME internal profile type

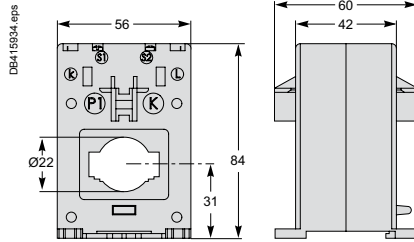

MB internal profile type

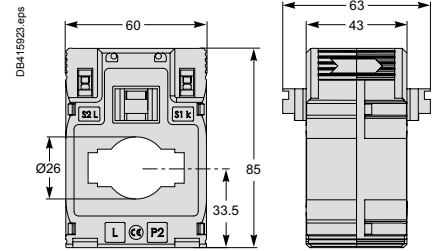

MA internal profile type

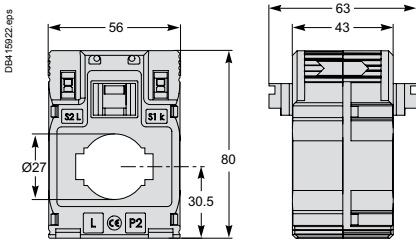

MC internal profile type

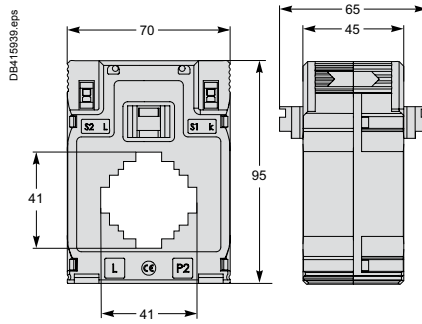

MF internal profile type

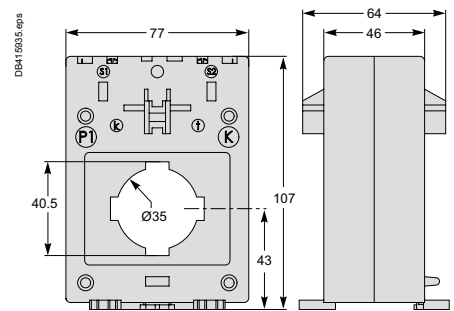

MD internal profile type

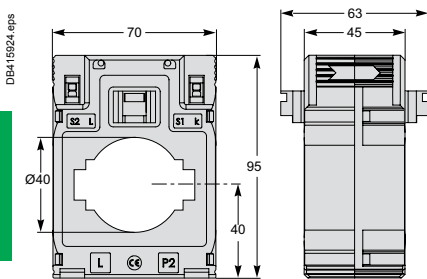

DA internal profile type

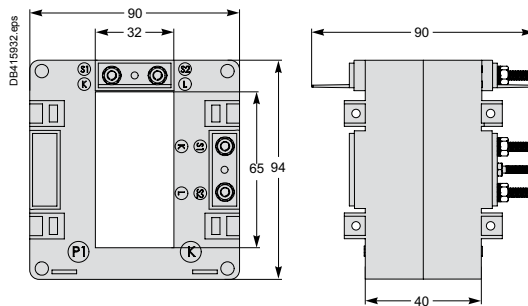

DB internal profile type

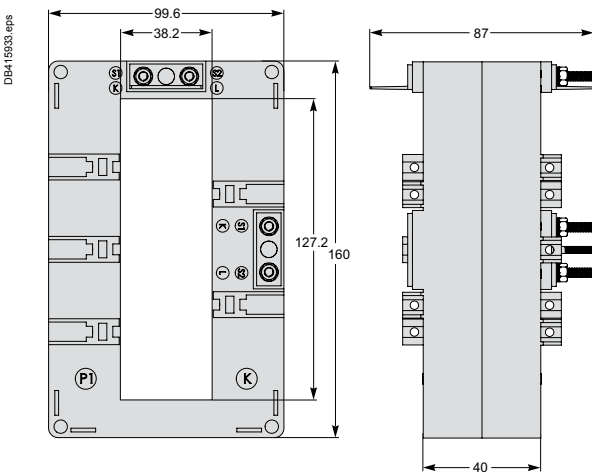

DC internal profile type

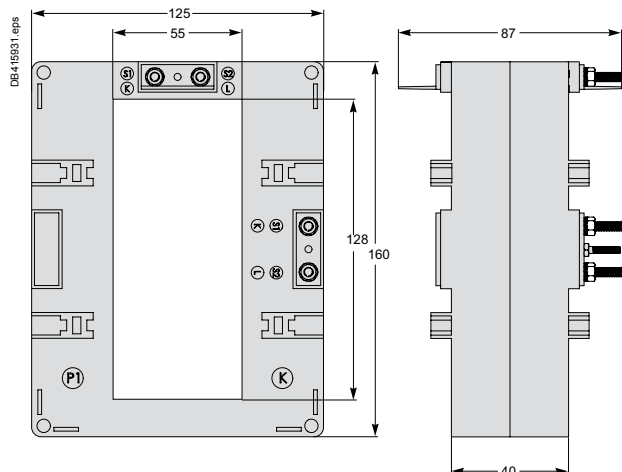

CT current transformers

DD internal profile type

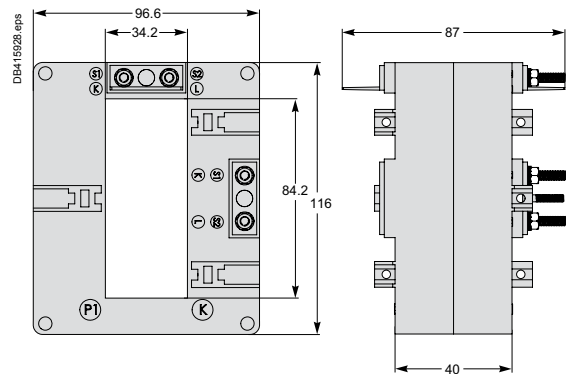

DE internal profile type

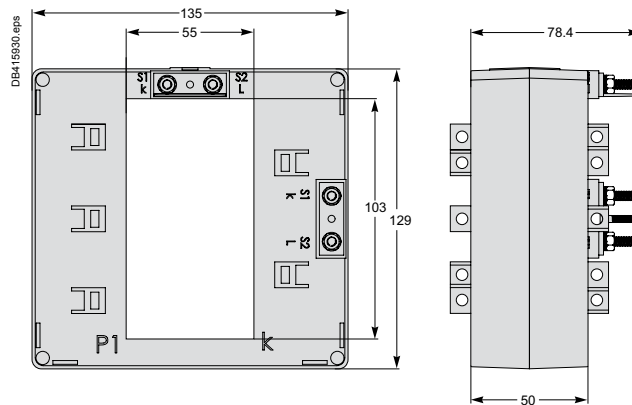

DH internal profile type

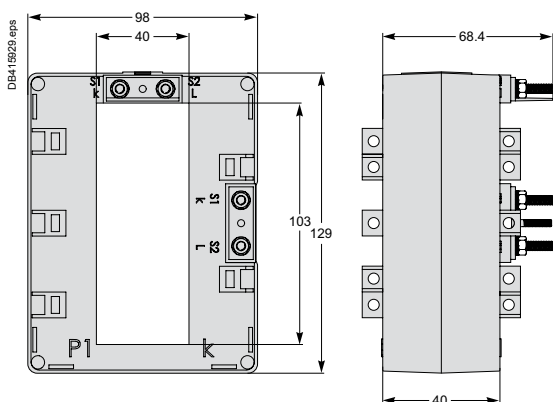

VV internal profile type

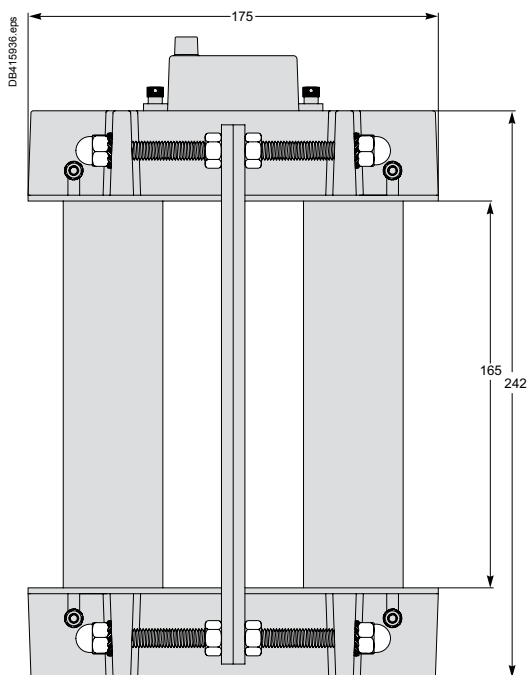

VF internal profile type

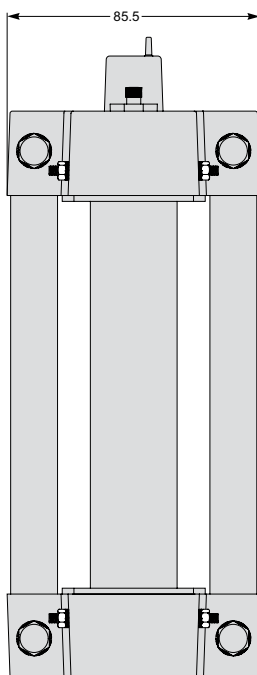

Cylinders

METSECT5CYL1

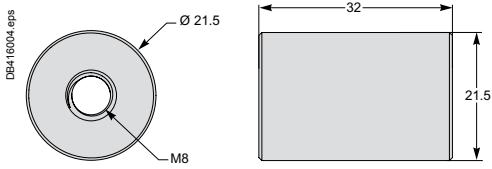

Aluminium

METSECT5CYL2

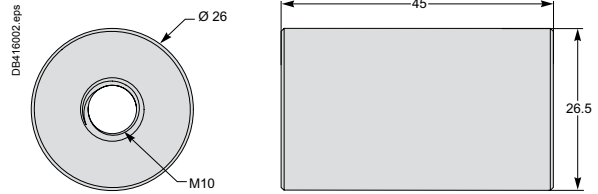

Aluminium

16550

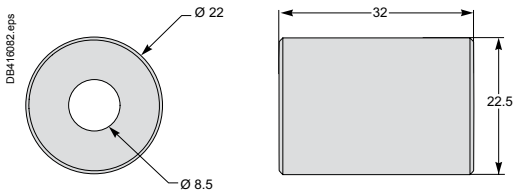

Brass

16551

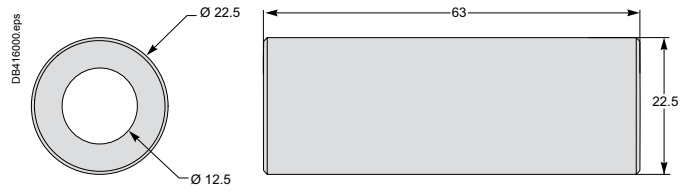

Brass

Covers

16552

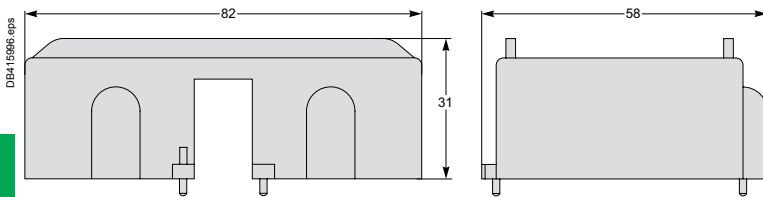

16553

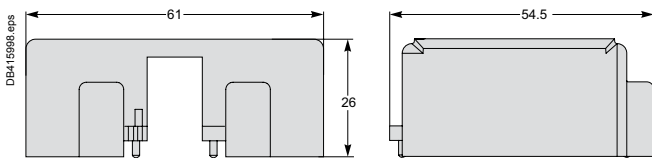

METSECT5COVER

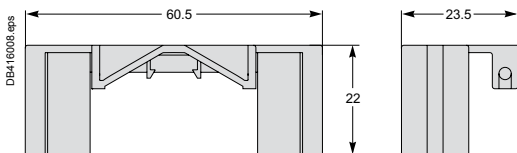



Application

The CH counters measure the total operating time of any load. The CI counters count 230Vac pulses from devices such as utility meters or people counters.

Specific technical data

CH

Electromechanical display

Maximum display: 99999.99 hours

Display accuracy: 0.01%

Without reset

Storage temperature: -25°C to +85°C

Connection: Tunnel terminals for 2.5mm² cable

Consumption: 0.15VA

Operating temperature: -10°C to +70°C

Mounting on symmetrical rail

CI

Supply and metering voltage: 230Vac, 50/60 Hz

Consumption: 0.15VA

Maximum display: 9 999 999 impulses

Without reset

Metering data Minimum impulse time: 50ms

Minimum time between 2 impulses: 50ms

Storage temperature: -25°C to +85°C

Operating temperature: -10°C to +70°C

Connection: Tunnel terminals for 2.5mm² cable

Type	Control voltage	Width in 18mm ways	Part number
CH	230Vac	2	15440
CI	230Vac	2	15443



CH

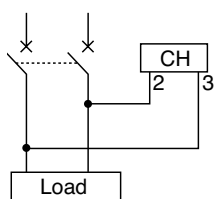

CI

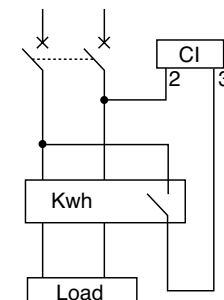

- Introduction** *pages 8/2 to 8/3*
- Selection table** *page 8/4*
- Circuit breaker installation** *page 8/5*
- Bottom entry** *pages 8/6 to 8/7*
 - Boards *page 8/6*
 - Incoming device *page 8/7*
- Top entry** *pages 8/8 to 8/9*
 - Boards *page 8/8*
 - Incoming device *page 8/9*
- Outgoing MCCBs** *pages 8/10 to 8/11*
- Technical data** *page 8/12*
- Auxiliary function possibilities** *page 8/13*
- Accessories** *pages 8/14 to 8/18*
 - Shrouding kit *page 8/14*
 - Extension enclosure *page 8/14*
 - Integrated control and distribution systems (ICDS) *page 8/15*
 - Replacement items *page 8/15*
 - Residual current protection modules *page 8/15*
 - Ammeter *page 8/15*
 - Metering facility *page 8/16*
 - Current transformer module *page 8/16*
 - Motor operator module *page 8/16*
 - Rotary handles with inbuilt padlocking facilities *page 8/16*
 - Toggle padlocking attachments *page 8/16*
 - Connection accessories *page 8/17*
 - Spreaders *page 8/17*
 - Auxiliary switch for 3 or pole devices only *page 8/17*
 - Voltage releases to fit all MCCBs 16/630A *page 8/17*
 - Terminal shields *page 8/17*
 - Single pole shrouding plates *page 8/17*
- Metering facilities for incoming and outgoing circuits** *pages 8/19 to 8/21*
- Intelligent panelboard** *page 8/22*
- Functions and characteristics** *pages 8/23 to 8/26*
- Metering and monitoring** *pages 8/27 to 8/28*





The range of wall and floor mounted Powerpact 4 panelboards is designed, manufactured and tested to BS EN 61439-1. The structures are rigid sheet steel finished in a cream colour epoxy powder (RAL 9001).

All the boards contain a unique connection system which ensures that all busbar/ breaker connections are tightened to the correct torque. The system comprises a tightening bolt head which shears off when the correct torque is reached. Facilities are provided to enable the breaker to be repositioned at a later time if so required.

The breaker range comprises single pole, single pole with switched neutral, double pole, triple pole and three pole with switched neutral and four pole. Incoming device ratings up to 1600A and outgoing ratings up to 630A.

The extremely flexible board design allows 1, 2, 3 and 4 pole breakers to be positioned in any order on the busbar stack thus allowing maximum use of the available space and also allowing breakers feeding associated loads to be positioned together.

For this reason the number of outgoing ways in the selection tables is expressed in single pole ways as well as three pole ways.

Full discrimination simply by missing a frame size.

Special breakers

Details of the standard breakers that may be fitted into the various sizes of panelboard are given on the following pages.

The full range of Compact NSX moulded case circuit breakers includes a wide range of breakers for special applications, higher breaking capacities, additional ratings and adaptations including rotary handles and motor mechanisms for remote operation. Most of these breakers, of ratings up to 630A, can be adapted for use in the Powerpact 4 panelboards.

To order these special breakers add the words ‘for use in Powerpact 4 panelboard’ to your ordering description of the breaker.

Application

The Powerpact 4 is the straight forward answer to all power requirements. It provides an off-the-shelf solution for most standard distribution applications.

Range

Powerpact 4 is available in many styles to suit various applications in wall mounted and floor standing up to 1600 amps incoming

- Style A is a wall mounted Powerboard with 250amp main bars up to 17 single pole outgoing ways. There is no dedicated incomer position giving complete flexibility in the use of the board: splitter board, 2 incomers/1 outgoing or as a conventional board
- Style C is a wall mounted Panelboard with 250 amp main bars and side mounted incomer up to 13 outgoing triple pole ways
- Style D is a wall mounted Panelboard with up to 630 amp main bars and vertically mounted incomer up to 18 triple pole outgoing ways
- Style E is a wall mounted Panelboard with 800 amp main bars and vertically mounted incomer up to 18 triple pole outgoing ways
- Style G is a floor standing Panelboard with 1600 amp main bars and the incomer mounted in its own cubicle 14 outgoing triple pole ways extendible to 28 TP ways

Technical data

Incoming	Up to 1600A
Outgoing	Up to 28 triple pole ways (84 single pole ways)
Main cable entry	Top or bottom
Metering	Incoming metering and Outgoing metering as an option (incoming standard on style G)
Manufactured and tested to	BS EN 61349-1
Busbars rated	Up to 1600A at 415V, 50Hz
Short circuit withstand	36 or 50kA for .5 or 1s
Construction	Rigid folded sheet steel with removable gland plates and end covers
Finish	Steelwork in polyester epoxy powder, cream colour RAL9001
Degree of protection	IP3X
Form 3b type 2	As standard
Form 4 type 2 & 6	Can be achieved by use of individual disconnectable neutral links adjacent to breakers or by the use of 4 pole breakers. Outgoing terminals should be shrouded with long terminal shields. The main neutral bar either side of the incomer should be removed and discarded together with the connecting copper bar. The incoming breaker should be a 4 pole breaker
Extension cubicles	Side/top/bottom extension cubicle is available as an extra



NSX moulded case circuit breakers

Powerpact 4 panelboards have a unique interconnection system which automatically gives the correct torque settings. 1, 2, 3, and 4 pole devices may be mixed to suit the installation needs without loss of space.

Metering

- A PowerLogic PM5000 series multi-function digital meter is fitted as standard to monitor the incoming supply on style G and as an option on other styles. It is also used for all outgoing metering. Readings available voltage, current, frequency, power, energy, demand values and harmonic distortion. The meter also provides a pulse output for kWh and kVArh.
- A side extension cubicle may be fitted on styles D/E/G which has provision for metering outgoing circuits, refer to metering on page 2/18. This cubicle also acts as a cable extension box.

Technical data for circuit breakers

Manufactured and tested to	BS EN 60947-2
Ics	100% Icu 16 - 630A, 75% Icu 800 - 1600A
Calibration temperature	40°C
Thermal adjustment	16 - 250A = 0.7 - 1 x In
(3 and 4 pole)	400 - 630A = 0.4 - 1 x In
	800 - 1600A = 0.4 x In

MCCB Icu & terminal size

- 16 - 100A 36kA 6mm bolt
- 160 - 250A 36kA 8mm bolt
- 400 - 630A 50kA 10mm bolt
- 800 - 1600 50kA 2 x 12mm bolts

Earth fault protection

- May be added to any 4 pole MCCB
- Sensitivities 30, 300mA 1, 3, 10A
- Time delay 0, 60, 150, 310 milli - seconds

800/1250/1600A breakers

800/1250/1600A breakers are fitted with Micrologic 5.0 control units to enable full discrimination with the outgoing breakers to be obtained. Alternative control units may be fitted if required.

250A panelboards

The main incoming device is side mounted at the bottom right hand side. If a 4 pole incomer is used the number of outgoing ways available is reduced by one single pole way. The incoming terminal shroud can be positioned to suit a 3 or 4 pole incoming breaker.

250A powerboard

One 3 pole terminal shield for a 250A breaker is supplied as standard for the main incoming terminals. Two adjacent 3 or 4 pole toggle operated breakers may be mechanically interlocked using Part number LV429354.

400/630A panelboard

The line (supply) terminals on the incoming device must be suitably shrouded. The board is supplied with 1 or 3 pole shroud for a 400/630A breaker. For other breakers suitable terminal shields should be ordered separately:

- 250A 3 pole LV429323
- 250A 4 pole LV429324
- 400/630A 4 pole LV432595

These terminal shields are supplied singly.



	250A Powerboard	250A Panelboard	400/630A Panelboard	800A Panelboard	1600A panelboard
Busbar short circuit withstand	36kA	36kA, 1s	36kA, 1s	50kA, 1s	50kA, 1s
Number of outgoing ways					
13SP inc incomer	■				
17SP inc incomer	■				
15SP (5TP)		■			
18SP (6TP)			■	■	
21SP (7TP)		■			
27SP (9TP)		■			
36SP (12TP)			■	■	
39SP (13TP)		■			
42SP (14TP)					■
54SP (18TP)			■	■	
84SP (28 TP)					□
Incoming device					
100A MCCB	□	□			
160A MCCB	□	□			
250A MCCB	□	□	□		
400A MCCB			□		
630A MCCB			□		
800A MCCB				■	
1250A MCCB					□
1600A MCCB					□
250A fuse switch		□			
Incomer - field installable	■	■	■	■	■
Two incomers, mechanically interlocked	□				
Main incoming cable entry					
Top		□	□	□	□
Bottom	■	□	□	□	□
Incoming metering	□		□	□	■
Outgoing metering	□		□	□	□
Top/bottom extension boxes		□	□	□	
Side extension boxes	□		□	□	□
Integrated control and distribution unit			□	□	
Earth leakage protection on outgoing circuits			□	□	□

Standard ■ Option □



The 4 pole busbar system ready to accept the circuit breaker.



The circuit breaker is placed in the panelboard and pushed up to the busbars. 1P, 2P, 3P and 4 pole breakers may be mixed in any order on the busbars.



The circuit breaker fixing screw is fitted and tightened to retain the breaker in the board. Retaining screw M5 8.5mm long.



The connections to the busbars are tightened until the tops of the connection bolts shear off. This ensures that the correct torque has been applied to the connections.



The circuit breaker is now mechanically & electrically connected in the panel board. It is now ready for the outgoing cables. Note how the breaker cassette fully shrouds the busbars. Unused positions must be fitted with blanking plates.

To remove (17mm bi-hexagonal socket)
RS number 572-864 (1/2")

Selection table

Powerpact 4 panelboards Bottom entry boards



Main cable entry at bottom

Busbar short circuit withstand	Number of incomer outgoing ways		Part number
	Single pole	Triple pole	
250A Powerboard			
Style A	13	3	MG25C2
36kA, 1s	17	4	MG25C4
	13	4 meters	MG25C2M
	17	4 meters	MG25C4M



Style C	15	5	MG2C5
36kA, 1s	21	7	MG2C7
	27	9	MG2C9
	39	13	MG2C13



400/630A Panelboard

Style D	18	6	MG6C6
36kA, 1s	36	12	MG6C12
	54	18	MG6C18

8



800A Panelboard

Style E	18	6	MG8C6
50kA, 1s	36	12	MG8C12
	54	18	MG8C18



1600A Panelboard

Style G	42	14	MG16C14
50kA, 1s	42	14 Extension cubicle	MG16CE14

Above supplied with 3 SP shrouds - 1600A supplied with 6

Powerpact 4 panelboards Bottom entry moulded case circuit breakers



Incoming devices

Current rating	Number of poles	Style of board	Part number
Circuit breaker			
100	3	A,C,D	MGP1003X
160	3	A,C,D	MGP1603X
250	3	A,C,D	MGP2503X
400	3	D	MGP4003X
630	3	D	MGP6303X
800	3	E	33552 + LV433638 + 33646
1250	3	G	33564
1600	3	G	33568

100	4	A,C,D	MGP1004X
160	4	A,C,D	MGP1604X
250	4	A,C,D	MGP2504X
400	4	D	MGP4004X
630	4	D	MGP6304X
800	4	E	33555 + LV433639 + 33646
1250	4	G	33566
1600	4	G	33570

If specifying alternative breakers for the 800A panelboard, one long terminal shield and one set of phase separators must also be ordered.

Switch disconnecter

100	3	A,C,D	MGP1003NAX
160	3	A,C,D	MGP1603NAX
250	3	A,C,D	MGP2503NAX
400	3	D	MGP4003NAX
630	3	D	MGP6303NAX
800	3	E	33487 + LV433638 + 33646
1250	3	G	33489
1600	3	G	33490

100	4	A,C,D	MGP1004NAX
160	4	A,C,D	MGP1604NAX
250	4	A,C,D	MGP2504NAX
400	4	D	MGP4004NAX
630	4	D	MGP6304NAX
800	4	E	33492 + LV433639 + 33646
1250	4	G	33494
1600	4	G	33495

Direct connection

250	3	C	MGP2503LL
250	4	C	MGP2504LL
630	4	D	MGPCIN

Protection must be provided upstream by a suitably rated breaker.

Disconnectable neutral link

250	1	A,C,D	MGP250NL
630	1	D	MGP630NL



Main cable entry at top

Busbar short circuit withstand	Number of outgoing ways		Part number
	Single pole	Triple pole	
250A Panelboard			
Style C	15	5	MG2C5
36kA, 1s	21	7	MG2C7
	27	9	MG2C9
	39	13	MG2C13



400/630A Panelboard

Style D	18	6	MG6C6
36kA, 1s	36	12	MG6C12
	54	18	MG6C18



800A Panelboard

Style E	18	6	MG8C6T
50kA, 1s	36	12	MG8C12T
	54	18	MG8C18T

8



1600A Panelboard

Style G	42	14	MG16C14T
50kA, 1s	42	14 Extension cubicle	MG16CE14T

Powerpact 4 panelboards

Top entry moulded case circuit breakers

Incoming devices			
Current rating	Number of poles	Style of board	Part number
Circuit breaker			
100	3	C	MGP1003X
160	3	C	MGP1603X
250	3	C	MGP2503X
100	3	D	MGP1003TX
160	3	D	MGP1603TX
250	3	D	MGP2503TX
400	3	D	MGP4003TX
630	3	D	MGP6303TX
800	3	E	33552 + LV433638 + 33646
1250	3	G	33564
1600	3	G	33568
100	4	C	MGP1004X
160	4	C	MGP1604X
250	4	C	MGP2504X
100	4	D	MGP1004TX
160	4	D	MGP1604TX
250	4	D	MGP2504TX
400	4	D	MGP4004TX
630	4	D	MGP6304TX
800	4	E	33555 + LV433639 + 33646
1250	4	G	33566
1600	4	G	33570
If specifying alternative breakers for the 800A panelboard, one long terminal shield and one set of phase separators must also be ordered.			
Switch disconnecter			
100	3	C	MGP1003NAX
160	3	C	MGP1603NAX
250	3	C	MGP2503NAX
100	3	D	
160	3	D	
250	3	D	MGP2503NATX
400	3	D	MGP4003NATX
630	3	D	MGP6303NATX
800	3	E	33487 + LV433638 + 33646
1250	3	G	33489
1600	3	G	33490
100	4	C	MGP1004NAX
160	4	C	MGP1604NAX
250	4	C	MGP2504NAX
100	4	D	
160	4	D	
250	4	D	MGP2504NATX
400	4	D	MGP4004NATX
630	4	D	MGP6304NATX
800	4	E	33492 + LV433639 + 33646
1250	4	G	33494
1600	4	G	33495
If specifying alternative breakers for the 800A panelboard, one long terminal shield is required for the incoming terminals			
Direct connection			
250	3	C	MGP2503LL
250	4	C	MGP2504LL
630	4	D	MGPCIN
Protection must be provided upstream by a suitably rated breaker.			
Disconnectable neutral link			
250	1	C,D	MGP250NL
630	1	D	MGP630NL



Rating	Module width (35mm)	Part Number		
--------	---------------------	-------------	--	--

Single pole

Breaking capacity 25kA at 230V

		L1	L2	L3
16	1	MGP0161L1	MGP0161L2	MGP0161L3
25	1	MGP0251L1	MGP0251L2	MGP0251L3
30	1	MGP0301L1	MGP0301L2	MGP0301L3
40	1	MGP0401L1	MGP0401L2	MGP0401L3
50		MGP0501L1	MGP0501L2	MGP0501L3
63	1	MGP0631L1	MGP0631L2	MGP0631L3
80	1	MGP0801L1	MGP0801L2	MGP0801L3
100	1	MGP1001L1	MGP1001L2	MGP1001L3
125	1	MGP1251L1	MGP1251L2	MGP1251L3
160	1	MGP1601L1	MGP1601L2	MGP1601L3



Two pole phase to neutral

Breaking capacity 85kA at 230V

		L1 - N	L2 - N	L3 - N
16	2	MGP0162L1N	MGP0162L2N	MGP0162L3N
25	2	MGP0252L1N	MGP0252L2N	MGP0252L3N
30	2	MGP0302L1N	MGP0302L2N	MGP0302L3N
40	2	MGP0402L1N	MGP0402L2N	MGP0402L3N
50		MGP0502L1N	MGP0502L2N	MGP0502L3N
63	2	MGP0632L1N	MGP0632L2N	MGP0632L3N
80	2	MGP0802L1N	MGP0802L2N	MGP0802L3N
100	2	MGP1002L1N	MGP1002L2N	MGP1002L3N
125	2	MGP1252L1N	MGP1252L2N	MGP1252L3N
160	2	MGP1602L1N	MGP1602L2N	MGP1602L3N



Two pole phase to phase

Breaking capacity 25kA at 415V

		L1 - L2	L2 - L3	L3 - L1
16	2	MGP0162L12	MGP0162L23	MGP0162L31
25	2	MGP0252L12	MGP0252L23	MGP0252L31
30	2	MGP0302L12	MGP0302L23	MGP0302L31
40	2	MGP0402L12	MGP0402L23	MGP0402L31
50		MGP0502L12	MGP0502L23	MGP0502L31
63	2	MGP0632L12	MGP0632L23	MGP0632L31
80	2	MGP0802L12	MGP0802L23	MGP0802L31
100	2	MGP1002L12	MGP1002L23	MGP1002L31
125	2	MGP1252L12	MGP1252L23	MGP1252L31
160	2	MGP1602L12	MGP1602L23	MGP1602L31



Rating	Module width (35mm)	Part Number
Three pole		
Breaking capacity 36kA at 415V		3 phase
16	3	MGP0163X
25	3	MGP0253X
32	3	MGP0323X
40	3	MGP0403X
50	3	MGP0503X
63	3	MGP0633X
80	3	MGP0803X
100	3	MGP1003X
125	3	MGP1253X
160	3	MGP1603X
200	3	MGP2003X
250	3	MGP2503X
400	4 ^{(1) (2)}	MGP4003X
630	4 ^{(1) (2)}	MGP6303X

Four pole		
Breaking capacity 36kA at 415V		3 phase + neutral
16	4	MGP0164X
25	4	MGP0254X
32	4	MGP0324X
40	4	MGP0404X
50	4	MGP0504X
63	4	MGP0634X
80	4	MGP0804X
100	4	MGP1004X
125	4	MGP1254X
160	4	MGP1604X
200	4	MGP2004X
250	4	MGP2504X
400	6 ^{(1) (2)}	MGP4004X One MGPBB25 also required
630	6 ^{(1) (2)}	MGP6303X One MGPBB25 also required

Disconnectable neutral links		
250	1	MGP250NL
630	2	MGP630NL One MGPBB25 also required

(1) If fitted in 630 or 800A board a shrouding kit is required.

(2) Breaking capacity 50kA at 415V.

Description	Part Number
Three pole	
PP4 MCCB 3P 16A 50kA	MGP0163XN
PP4 MCCB 3P 25A 50kA	MGP0253XN
PP4 MCCB 3P 32A 50kA	MGP0323XN
PP4 MCCB 3P 40A 50kA	MGP0403XN
PP4 MCCB 3P 50A 50kA	MGP0503XN
PP4 MCCB 3P 63A 50kA	MGP0633XN
PP4 MCCB 3P 80A 50kA	MGP0803XN
PP4 MCCB 3P 100A 50kA	MGP1003XN
PP4 MCCB 3P 125A 50kA	MGP1253XN
PP4 MCCB 3P 160A 50kA	MGP1603XN
PP4 MCCB 3P 200A 50kA	MGP2003XN
PP4 MCCB 3P 250A 50kA	MGP2503XN

Four pole	
PP4 MCCB 4P 16A 50kA	MGP0164XN
PP4 MCCB 4P 25A 50kA	MGP0254XN
PP4 MCCB 4P 32A 50kA	MGP0324XN
PP4 MCCB 4P 40A 50kA	MGP0404XN
PP4 MCCB 4P 50A 50kA	MGP0504XN
PP4 MCCB 4P 63A 50kA	MGP0634XN
PP4 MCCB 4P 80A 50kA	MGP0804XN
PP4 MCCB 4P 100A 50kA	MGP1004XN
PP4 MCCB 4P 125A 50kA	MGP1254XN
PP4 MCCB 4P 160A 50kA	MGP1604XN
PP4 MCCB 4P 200A 50kA	MGP2004XN
PP4 MCCB 4P 250A 50kA	MGP2504XN

Three pole (ML2.2)	
PP4 MCCB 3P 40A (ML2.2)	MGP0403XE2
PP4 MCCB 3P 100A (ML2.2)	MGP1003XE2
PP4 MCCB 3P 160A (ML2.2)	MGP1603XE2
PP4 MCCB 3P 250A (ML2.2)	MGP2503XE2
PP4 MCCB 3P 40A (ML2.2) 50kA	MGP0403XE2N
PP4 MCCB 3P 100A (ML2.2) 50kA	MGP1003XE2N
PP4 MCCB 3P 160A (ML2.2) 50kA	MGP1603XE2N
PP4 MCCB 3P 250A (ML2.2) 50kA	MGP2503XE2N

Four pole (ML2.2)	
PP4 MCCB 4P 40A (ML2.2)	MGP0404XE2
PP4 MCCB 4P 100A (ML2.2)	MGP1004XE2
PP4 MCCB 4P 160A (ML2.2)	MGP1604XE2
PP4 MCCB 4P 250A (ML2.2)	MGP2504XE2
PP4 MCCB 4P 40A (ML2.2) 50kA	MGP0404XE2N
PP4 MCCB 4P 100A (ML2.2) 50kA	MGP1004XE2N
PP4 MCCB 4P 160A (ML2.2) 50kA	MGP1604XE2N
PP4 MCCB 4P 250A (ML2.2) 50kA	MGP2504XE2N

Three pole (ML5.3E)	
PP4 MCCB 3P 400A (ML5.3E)	MGP4003X5E
PP4 MCCB 3P 630A (ML5.3E)	MGP6303X5E

Four pole (ML5.3E)	
PP4 MCCB 4P 400A (ML5.3E)	MGP4004X5E
PP4 MCCB 4P 630A (ML5.3E)	MGP6304X5E

Dimensions

Type	Height mm	Width mm	Depth mm	(1)	Weight kg
Style A - 250A powerboard					
3 way	650	600	268		32
4 way	650	778	268		57

Style C - 250A panelboard					
5 way	680	853	260	198	40
7 way	785	853	260	198	44
9 way	890	853	260	198	50
13 way	1075	853	260	198	60

Style D - 400/620A panelboard					
6 way	1178	850	260	290	66
12 way	1493	850	260	290	89
18 way	1808	850	260	290	98

Style E - 800A panelboard					
6 way	1580	850	260	490 ⁽³⁾	86
12 way	1896	850	260	490 ⁽³⁾	104
18 way	2210	850	260	490 ⁽³⁾	122

Style G - 1600A panelboard					
14 way	2106	1256	450	708 ⁽²⁾	375
14 way extension	2106	850	450		200

- (1) Distance from gland plate to incoming terminals
- (2) Terminals will accept up to 3 lugs 400mm² per phase
- (3) Main connection M12 bolt

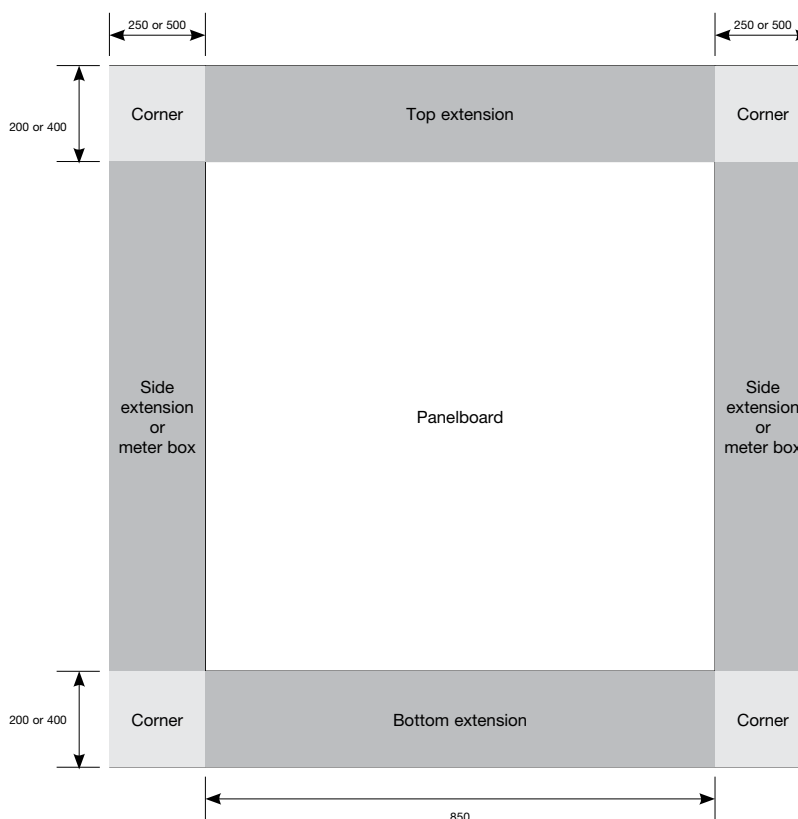

Note: Side extensions and corner units cannot be fitted to 250A panelboards

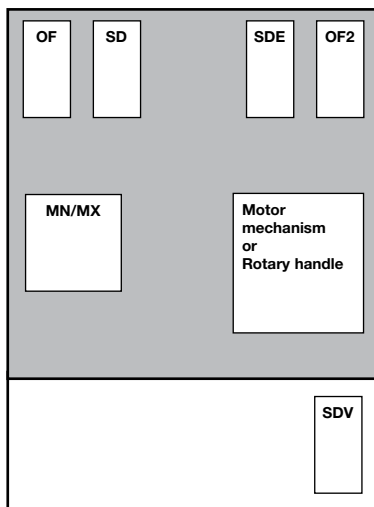

NSX100/160/250

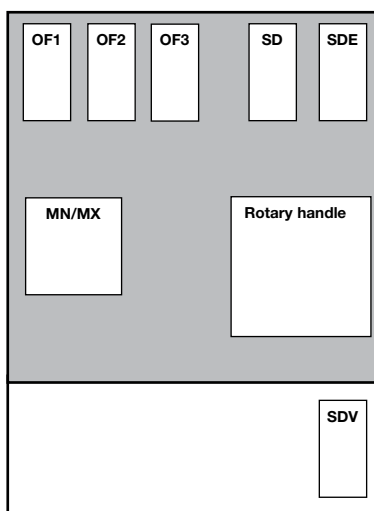

NSX400/630

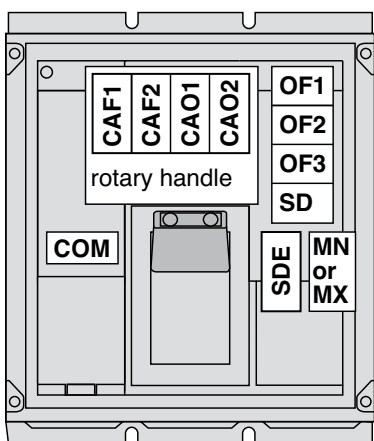

NS800/1600

- OF** Changeover auxiliary contact
- SD** Changeover alarm switch
- MX** Shunt trip
- MN** Undervoltage release
- SDE** Fault alarm
- SDV** Earth fault alarm
- CAF** Early make auxiliary contacts (with rotary handle)
- CAO** Early break auxiliary contacts (with rotary handle)
- COM** Communications function

All accessories are capable of being fitted on site. Full details may be obtained from the Compact NS moulded case circuit breaker catalogue.

Manually operated device



Shrouding kit (400/630A and 800A panelboards only)

Provides additional support for device and shrouding for front cover. One shrouding kit must be used per side when fitting either outgoing 400/630A MCCBs or outgoing ammeter and/or earth leakage protection. In addition to the shrouding kit an additional 25mm three stage filler piece is required when 4 pole 400A or 630A circuit breakers are fitted on the outgoing pan assembly **MGPTSF25**.

Number of outgoing ways		Part number
SP	TB	
18	6	MGPCH6
36	12	MGPCH12
54	18	MGPCH18

Extension enclosure

250A powerboard style A side extension

TP ways	Mounting arrangement	Part number
Side	Top/bottom	
3	W600	MG25EXC
4	W600	MG25EXC

250A panelboard style C top or bottom extension

5,7,9,13	H200	MG6CEX
----------	------	---------------

More than one extension can be added if required.

400/630A panelboard style D and 800A panelboard style E top or bottom extension

Top/bottom ext.	6,12,18	H200	MG6CEX
-----------------	---------	------	---------------

Side extensions

Side ext. 6	W250	MGPXC206
Side ext. 12	W250	MGPXC212
Side ext. 18	W250	MGPXC218
Side ext. 6	W500	MGPXC506
Side ext. 12	W500	MGPXC512
Side ext. 18	W500	MGPXC518

For side extensions with metering facility see page 8/20.

More than one extension can be added if required. Side extensions are recommended when 400A and 630A outgoers are fitted or when outgoing circuit breakers have earth fault protection.

Corner units style D/E

W250	H200	MGPC2025
W500	H200	MGPC2050
W250	H400	MGPC4025
W500	H400	MGPC4050

For squaring off a panelboard when a top or bottom extension and side extension are used together, and side extension are used together.

1600A panelboard style G side extension

14	W400	MG16CEX4
----	------	-----------------

More than one extension can be added if required.

Metering MG16CEM4

Replacement items

Door and cover assembly

250A powerboard	9 way	MG25FCC2
	13 way	MG25FCC4
	9 way + metering	MG25FCC2M
	13 way + metering	MG25FCC4M
400/630A panelboard	18 way	MG6FCC6
	36 way	MG6FCC12
	54 way	MG6FCC18
800A panelboard	18 way	MG8FCC6
	36 way	MG8FCC12
	56 way	MG8FCC18
Gland plate for 400/630/800A panelboard		MGPGPC8
Door lock kit up to 800A		MGPP4S007
2 spare door keys		MGK33
Touch up paint RAL9001	Spray	08962
	Brush	08961
Adhesive drawing pocket	RAL9001	08963

Residual current protection modules

Using 4 pole residual current add-on modules (Vigi block) for incoming or outgoing ways (requires a 4 pole MCCB).

Frame rating	Earth leakage tripping current options (A)	Current rating MCCB	Vigi module Part number
Up to 160A	0.03 - 0.3 - 1 - 3 - 10*	NSX100/160	LV429211
200 - 250A	0.03 - 0.3 - 1 - 3 - 10*	NSX250	LV431536
400 - 630A	0.3 - 1 - 3 - 10 - 30*	NSX400/630	LV432456

* Time delay settings (ms) 0 - 60 - 150 and 310 (30mA - instantaneous only).

(i) For combinations of items of RCD's, metering and remote metering please contact us for further information.





Metering facility

- 3 phase current transformer module with voltage measurement outputs.
- Fits directly on the terminals of the breaker.
- The voltage measurement outputs have inbuilt protection with automatic reset.
- Suitable for use with the PowerLogic range of meters.

Breaker	CT ratio	VA output	Class at VA output	Part number	
				3 pole	4 pole
NS100	125/5	1.1	1.0	LV429461	LV429462
NS160	150/5	1.1	1.0	LV430561	LV430562
NS250	250/5	1.1	0.5	LV431569	LV431570
NS400	400/5	2.0	0.5	LV432653	LV432654
NS630	600/5	2.0	0.5	LV432861	LV432862



Current transformer module nt transformer module

- 3 phase current transformer module.
- Fits directly on the terminals of the breaker.

Breaker	CT ratio	VA output	Class at VA output	Part number	
				3 pole	4 pole
NS100	125/5	1.6	3.0	LV429457	LV429458
NS160	150/5	3.0	3.0	LV430557	LV430558
NS250	250/5	5.0	3.0	LV431567	LV431568
NS400	400/5	8.0	3.0	LV432657	LV432658
NS630	600/5	8.0	3.0	LV432857	LV432858



Motor operator module

All 3 pole and 4 pole breakers up to 250A can be fitted with a motor operator mechanism allowing remote opening and closing of the circuit breaker.

Operating voltages

50Hz	a.c.	48 - 415V
	d.c.	24 - 250V

Specify requirements at time of ordering the breaker.



Rotary handles with inbuilt padlocking facilities

Current rating	Part number	
	Black	Red/yellow
Up to 250A	LV429337	LV429339
400/630A	LV432597	LV432599

Toggle padlocking attachments Locking in OFF position

Current rating	Part number	
	Removable	Fixed
250A	29370	LV429371
630A	29370	LV432631
800A	44936	LV432631



Connection accessories

Bare cable connectors

Capacity	Breaker	Part number	
		Set of 3	Set of 4
1.5 - 95mm ²	160	LV429242	LV429243
10 - 185mm ²	250	LV429259	LV429260
35 - 300mm ²	630	LV432479	LV432480
2 x 95 - 240mm ²	630	LV432481	LV432482

Crimp cable lugs supplied with phase barriers

120mm ² copper	250	LV429252	LV429256
150mm ² copper	250	LV429253	LV429257
185mm ² copper	250	LV429254	LV429258
240mm ² copper	630	LV432500	LV432501
300mm ² copper	630	LV432502	LV432503
150mm ² aluminium	250	LV429504	LV429505
185mm ² aluminium	250	LV429506	LV429507
240mm ² aluminium	630	LV432504	LV432505
300mm ² aluminium	630	LV432506	LV432507

Spreaders

A	Pole pitch mm	Quantity	Part number
250	45	Set of 3	LV431563
250	45	Set of 4	LV431564
630	52.5	Set of 3	LV432490
630	52.5	Set of 4	LV432491

Auxiliary switch for 3 or 4 pole devices only

- For all MCCBs
- Used to indicate open, closed or tripped status
- SDE adaptor required for trip unit devices up to 250A TM or MA (to indicate trip on overcurrent). **Two** auxiliary switches will be needed to indicate open, closed **and** tripped status

	Part number
Auxiliary changeover switch	29450
SDE adaptor	29451

Voltage releases to fit all MCCBs 16/630A for 3 or pole devices only

AC 50/60Hz Voltage (V)	Part number Shunt trip (MX)	Undervoltage release (MN)
200/240	LV429387	LV429407
380/415	LV429388	LV429408

Other voltages available - refer to Compact NSX catalogue.

Terminal shields

Current rating (A)	Part number
Up to 160A single pole and 250A neutral link	LV429320
Up to 160A 2 pole	LV429320 x 2
Up to 250A 3 pole (single) long	LV429517
Up to 250A 4 pole (single) long	LV429518
Up to 400/630A 3 pole (single)	LV432593
Up to 400/630A 4 pole (single)	LV432594

For shielding a TP MCCB with neutral link use the 4 pole terminal shield.

Single pole shrouding plates

MGPBBP	MGPBB25
Single pole shrouding plates are required for each unoccupied outgoing way.	In addition a 25mm shrouding plate is always required when 4 pole 400A or 630A circuit breakers are mounted on the outgoing pan assembly.

Boards up to 800A are supplied with 3 x MGPBBP. 1600A board is supplied with 6 x MGPBBP.

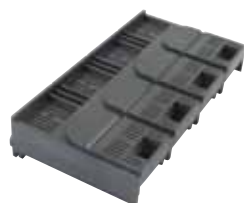



The PowerLogic PM5000 series power meter offers all the measurement capabilities required to monitor an electrical installation in a single 96 x 96 mm unit extending only 72 mm behind the mounting surface. With its large display, you can monitor all three phases and neutral at the same time. The anti-glare display features large 11 mm high characters and powerful backlighting for easy reading even in extreme lighting conditions and viewing angles.

The PowerLogic PM5000 series meters are available in 12 versions:

- PM5100, basic metering with up to 15th individual harmonic measurement and one pulse output for energy metering
- PM5110, same function as PM5100, plus RS485 port for Modbus communication
- PM5111, same function as PM5110, plus MID certified
- PM5310, basic metering with up to 31st individual harmonic measurement, 256KB data logging, two digital inputs, two digital output and one RS485 port for Modbus communication
- PM5320, basic metering with up to 31st individual harmonic measurement, 256KB data logging, two digital inputs, two digital output and one Ethernet port for Modbus TCP/IP communication
- PM5330, same function as PM5310, plus two relay outputs
- PM5331, same function as PM5330, plus MID certified
- PM5340, same function as PM5320, plus two relay outputs
- PM5341, same function as PM5340, plus MID certified
- PM5560, basic metering with up to 63rd individual harmonic measurement, 1.1MB data logging, four digital inputs, two digital outputs, one RS485 port for Modbus and two Ethernet port for Modbus TCP/IP communications, embedded webpages
- PM5561, same function as PM5560, plus MID certified
- PM5563, same function as PM5560, but DIN rail mounted without display

Applications

Sub billing/tenant metering
 Cost allocation
 Basic Power Quality monitoring
 Min/Max monitoring with timestamp
 Programmed alarming
 WAGES monitoring

Characteristics

Requires only 72 mm behind mounting surface

The Power Meter Series 5000 can be mounted on switchboard doors to maximise free space for electrical devices.

Large back lit display with integrated bar charts

Displays 4 measurements at a time for fast readings.

Intuitive use

Easy navigation using context-sensitive menus.

Power and current demand, THD ,TDD, individual harmonics and min/max reading in basic version

A high-performance solution for trouble-free monitoring of your electrical installation.

Active energy IEC 62053-22 class 0.5S (PM5100 and PM5300 models) and class 0.2S (PM5500 models)

Suitable for cost-allocation applications.

Legal billing compliance

Meets EN50470-1/3-Class C that specifies requirements for billing applications.

Performance measuring and monitoring devices

Meet IEC 61557-12 PMD/S/K55/0.5 (PM5100 and PM5300 models) and IEC61557-12 PMD/S/K55/0.2 (PM5500 model) that specifies requirements for combined Performance Measuring and monitoring Devices (PMD)

Innovative Power Meter

RS 485 communications, alarming and digital I/O in a single Power Meter (PM5310).



Power meter inputs

The NSX moulded case circuit breakers up to 630A have current transformer modules that fit directly on to the load terminals of the breaker. As well as the current transformer coils they also have self protected voltage connections off each phase. This eliminates the need to have additional overcurrent protection on these circuits. The meter is wired direct from this CT module without the need for any intermediate devices.

Panelboard configurations

250A Powerboard

There are two versions of this equipment, basic or with the facility to have metering. The meter versions allow metering to be added to any 3 or 4 pole MCCB fitted in the board. All components are easily fitted; there are no extension boxes to fit or apertures to cut. The meters are positioned behind the overall lockable door preventing unauthorised access to the meters. MG25C2M has 4 apertures, MG25C4M has 5.

Note: the meters and CT modules must be ordered separately. The wiring looms to link the CT modules to the meters are included with the panelboards.

Metering options are not available for the 250A panelboard. It is recommended that a MG6Pxx board is used with a 250A incomer.

Ordering references

250A powerboard with metering facility

13 SP positions	MG25C2M
17 SP positions	MG25C4M

250A Panelboard

Incoming/Outgoing metering

The metering extension box allows for metering for the incoming and outgoing devices to be metered. The kit comes complete with a fuse holder and wiring looms to provide power to the meters. The meters and CT modules are ordered separately.

630 & 800A Panelboards

Incoming metering

This is easily added to a board when it is first being installed. The kit comprises an extension box that houses the meter and, when fitted to the same end of the board as the incoming cables, provides additional space for the main incoming cables. All components including the meter, CTs and wiring is included in the kit. The meter is fully set up for the CT ratio and the voltage configuration.

Outgoing circuit metering

Metering can be fitted to some or all of the three phase outgoing circuits on 630A & 800A boards whether the boards are fitted with incoming metering or not.

The arrangement consists of side extension boxes that house the meters and also provide additional cabling space. Meters and current transformers are ordered separately to meet the needs of the installation. The necessary cable looms are included with the steelwork. The meters are mounted on hinged doors. The box also contains the auxiliary busbar that provides the 240V control supply for the meters. The left hand extensions have sufficient meter positions for half the number of outgoing ways. The right hand extensions have positions for half the number of outgoing ways plus three additional positions. These extra positions may be used for additional metering or mounting surge arresters, control fuses etc. The lower two positions have a transparent window and DIN rail. This can be removed if not required.

Note: the meters, CT modules and surge arresters must be ordered separately

Incoming and outgoing metering for boards up to 630A

(This arrangement is not applicable for boards fitted with MGPINC direct connections). When both incoming and outgoing metering is required there is a very cost effective solution by incorporating the incoming metering into the right hand side extension box. Components required are:

- Standard extension box MG6CEX to provide the required cable spreading space
- Current transformer module to fit on line side of incoming breaker.
- PM750MG meter.
- Two MGPC2025 corner units, optional

The meter should be cabled to the CT module according to the diagram supplied. (loom not supplied). The auxiliary supply to the meter should be taken from one phase and neutral and must be suitably fused.

Note. A warning notice should be placed in the board as the voltage connections are taken off the live side of the main breaker.

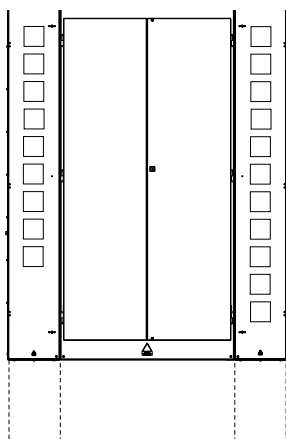
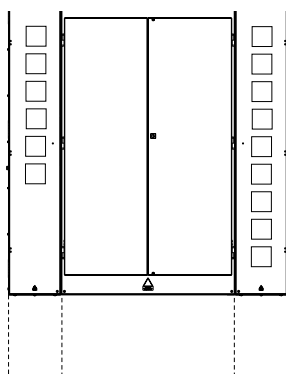
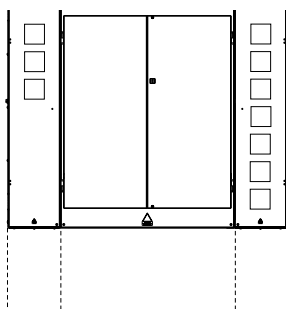

MG2C* 250A board

Incoming metering kit 250A	MG6CEXM
----------------------------	----------------

MG6Cxx 630A board

Incoming metering kit 400A	MG64M
630A	MG66M

MG8Cxx 800A board

Incoming metering kit 800A	MG88M
MG88MX - less meter	

630A & 800A outgoing metering side extension boxes

6 way board	Left hand side (*)	3 meter positions	MGPCM6L
	Right hand side (*)	7 meter positions	MGPCM6R
12 way board	Left hand side (*)	6 meter positions	MGPCM12L
	Right hand side (*)	9 meter positions	MGPCM12R
18 way board	Left hand side (*)	9 meter positions	MGPCM18L
	Right hand side (*)	11 meter positions	MGPCM18R

(*) When the board is inverted for top entry main cables these side extensions fit on the other side of the board.

Accessories

Cable loom	MGPCML
Meter blanks	03908

1600A Panelboards

Incoming metering

A PM750MG meter is fitted as standard in the board. The meter is fully set up for use on a 415V 3ph 4 wire system and for use with the 1600/5 current transformers that are installed on the busbars.

Outgoing circuit metering

Metering can be fitted to some or all of the three phase outgoing circuits in these boards. The arrangement consists of a side extension cubicle that houses the meters and also provides additional cabling space. Meters and current transformers are ordered separately to meet the needs of the installation. The necessary cable looms are included with the cubicle.

The meters are mounted on the front, hinged cover of the cubicle and can be aligned with their associated breaker. The cubicle also contains the auxiliary busbar that provides the 240V control supply for the meters

1600A panelboard

Side extension cubicle

MG16CEM4

Current transformer modules for direct fitting to NS breakers in all boards

Breaker	Poles	CT ratio	Part number
NS100X	3	125/5	LV429461
NS100X	4	125/5	LV429462
NS160X	3	150/5	LV430561
NS160X	4	150/5	LV430562
NS250X	3	250/5	LV431569
NS250X	4	250/5	LV431570
NS400X	3	400/5	LV432653
NS400X	4	400/5	LV432654
NS630X	3	600/5	LV432861
NS630X	4	600/5	LV432862

Unused 92 x 92 metering apertures can be blanked off using Part number **03908**
All these CT modules have voltage connections.



The intelligent panelboard system utilises the advanced features of the Compact NSX range with Micrologic 5 trip units for integrated protection, metering, measuring and monitoring.

With no requirement for external current transformers and an advanced plug and play communication cable system, on site adaptation is tool free, simple and quick to install.

This system is available in 4 levels for incoming and outgoing devices.

- 1 Local display on the NSX breaker only
- 2 Local display plus data available via Modbus
- 3 Local display and remote functional display on the panelboard
- 4 Local display and remote functional display on the panelboard plus data available via Modbus

All devices are 4 pole and may be configured into a form 4b type 2 or 6 to BSEN 61439-1

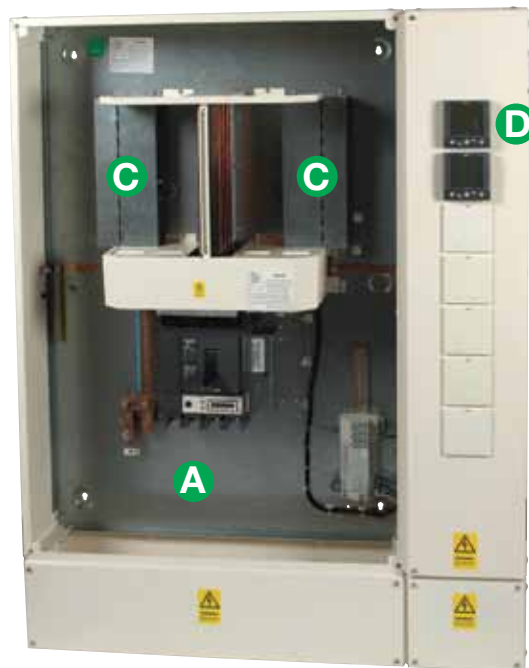

Key
A - Main incomer
B - Interface kit
C - Outgoing devices area
D - Display modules

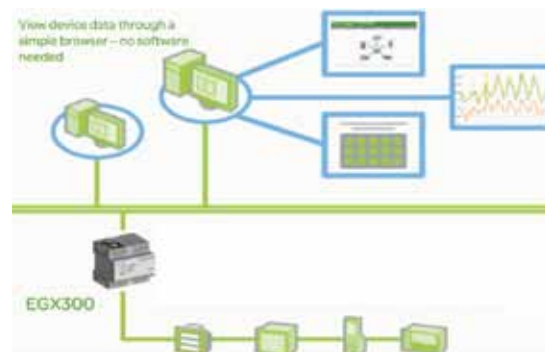

Make your panel board smarter simply by using the Powerlogic EGX300.

The integrated gateway-server Powerlogic EGX300 is used to optimise energy usage, and identify opportunities to save energy.

The user friendly tool uses only the web browser and network to display the energy consumption on panel boards, incorporating meters, NSX and communicating NS breakers, trend plots from the electrical system and stores historical information from multiple locations.

The din rail mounted device can be fitted in any Power pact 4 panelboard using the webserver power and interface kit **SEPINTPEGX**.

In addition to protection functions, Micrologic 5 offers all the functions of Power Meter products as well as operating assistance for the circuit breaker:

- Display of settings
- Measurement functions:
 - Energy (E)
- Alarms
- Time stamped histories and event tables
- Maintenance indicator
- Communication

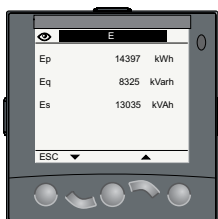
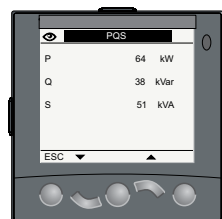
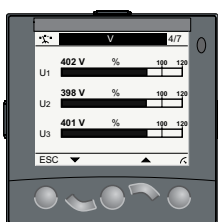
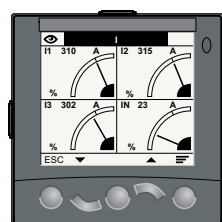
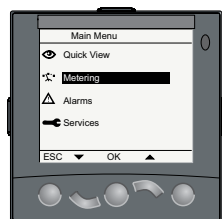

Micrologic E measurement functions are made possible by Micrologic intelligence and the accuracy of the sensors. They are handled by a microprocessor that operates independent of protection functions.

Display



Micrologic LCD

The user can display all the protection settings and the main measurements on the LCD screen of the trip unit.

- Instantaneous rms current measurements
 - Micrologic E voltage, frequency and power measurements and energy metering
- To make the display available under all conditions and increase operating comfort, an external power supply is recommended.

It is indispensable to:

- Display faults and interrupted current measurements
- Use all the functions of Micrologic E (e.g. metering of low power and energy values)
- Ensure operation of the communication system

The external power supply can be shared by several devices.

FDM121 display unit

An FDM121 switchboard display unit can be connected to a Micrologic trip unit using a prefabricated cord to display all measurements on a screen. The result is a veritable 96 x 96 mm Power Meter.

In addition to the information displayed on the Micrologic LCD, the FDM121 screen shows demand, power quality and maximeter/minimeter values along with alarms, histories and maintenance indicators.

The FDM121 display unit requires a 24 V DC power supply. The Micrologic trip unit is supplied by the same power supply via the cord connecting it to the FDM121.

PC screen

When the Micrologic, with or without an FDM121 switchboard display unit, is connected to a communication network, all information can be accessed via a PC.



Measurements

Instantaneous rms measurements

The Micrologic E continuously display the RMS value of the highest current of the three phases and neutral (Imax). The navigation buttons can be used to scroll through the main measurements.

In the event of a fault trip, the current interrupted is memorised.

Measures phase, neutral, ground fault currents plus voltage, frequency and power measurements

Maximeters / minimeters

Every instantaneous measurement provided by Micrologic E can be associated with a maximeter/minimeter. The maximeters for the highest current of the 3 phases and neutral, the demand current and power can be reset via the trip unit keypad, the FDM121 display unit or the communication system.

Energy metering

The Micrologic E also measures the energy consumed since the last reset of the meter. The active energy meter can be reset via the keypad and the FDM121 display unit or the communication system.

Demand and maximum demand values

Micrologic E also calculates demand current and power values. These calculations can be made using a block or sliding interval that can be set from 5 to 60 minutes in steps of 1 minute. The window can be synchronised with a signal sent via the communication system. Whatever the calculation method, the calculated values can be recovered on a PC via Modbus communication.

Ordinary spreadsheet software can be used to provide trend curves and forecasts based on this data. They will provide a basis for load shedding and reconnection operations used to adjust consumption to the subscribed power.

Power quality

Micrologic E calculates power quality indicators taking into account the presence of harmonics up to the 15th order, including the total harmonic distortion (THD) of current and voltage.





Micrologic 5 / 6 integrated Power Meter functions				Display		
				E	Micrologic LCD	FDM121 display
Display of protection settings						
Pick-ups (A) and delays	All settings can be displayed	I _r , t _r , I _{sd} , t _{sd} , I _i , I _g , t _g	■	■		
Measurements						
Instantaneous rms measurements						
Currents (A)	Phases and neutral	I ₁ , I ₂ , I ₃ , I _N	■	■		■
	Average of phases	I _{avg} = (I ₁ + I ₂ + I ₃) / 3	■	-		■
	Highest current of the 3 phases and neutral	I _{max} of I ₁ , I ₂ , I ₃ , I _N	■	■		■
	Ground fault (Micrologic 6)	% I _g (pick-up setting)	■	■		■
	Current unbalance between phases	% I _{avg}	■	-		■
Voltages (V)	Phase-to-phase	U ₁₂ , U ₂₃ , U ₃₁	■	■		■
	Phase-to-neutral	V _{1N} , V _{2N} , V _{3N}	■	■		■
	Average of phase-to-phase voltages	U _{avg} = (U ₁₂ + U ₂₁ + U ₂₃) / 3	■	-		■
	Average of phase-to-neutral voltages	V _{avg} = (V _{1N} + V _{2N} + V _{3N}) / 3	■	-		■
	Ph-Ph and Ph-N voltage unbalance	% U _{avg} and % V _{avg}	■	-		■
	Phase sequence	1-2-3, 1-3-2	■	■		■
Frequency (Hz)	Power system	f	■	■		■
Power	Active (kW)	P, total / per phase	■	■		■
	Reactive (kVAR)	Q, total / per phase	■	■		■
	Apparent (kVA)	S, total / per phase	■	■		■
	Power factor and cos φ (fundamental)	PF and cos φ, total and per phase	■	-		■
Maximeters / minimeters						
	Associated with instantaneous rms measurements	Reset via Micrologic or FDM121 display unit	■	-		■
Energy metering						
Energy	Active (kW), reactive (kVARh), apparent (kVAh)	Total since last reset Absolute or signed mode ⁽¹⁾	■	■		■
Demand and maximum demand values						
Demand current (A)	Phases and neutral	Present value on the selected window	■	-		■
		Maximum demand since last reset	■	-		■
Demand power	Active (kWh), reactive (kVAR), apparent (kVA)	Present value on the selected window	■	-		■
		Maximum demand since last reset	■	-		■
Calculation window	Sliding, fixed or com-synchronised	Adjustable from 5 to 60 minutes in 1 minute steps	■	-		(2)
Power quality						
Total harmonic distortion (%)	Of voltage with respect to rms value	THDU, THDV of the Ph-Ph and Ph-N voltage	■	-		■
	Of current with respect to rms value	THDI of the phase current	■	-		■

(1) Absolute mode: E absolute = E out + E in; Signed mode: E signed = E out - E in.

(2) Available via the communication system only.

Additional technical characteristics

Measurement accuracy

Accuracies are those of the entire measurement system, including the sensors:

- Current: Class 1 as per IEC 61557-12
- Voltage: 0.5 %
- Power and energy: Class 2 as per IEC 61557-12
- Frequency: 0.1 %

Micrologic measurement capabilities come into full play with the FDM121 switchboard display. It connects to Compact NSX via a simple cord and displays Micrologic information. The result is a true integrated unit combining a circuit breaker and a Power Meter. Additional operating assistance functions can also be displayed.



FDM121 display.



Surface mount accessory.



Connection with FDM121 display unit.

FDM121 switchboard display

The FDM121 is a switchboard display unit that can be integrated in the Compact NSX100 to 630 A system. It uses the sensors and processing capacity of the Micrologic trip unit. It is easy to use and requires no special software or settings. It is immediately operational when connected to the Compact NSX by a simple cord. The FDM121 is a large display, but requires very little depth. The anti-glare graphic screen is backlit for very easy reading even under poor ambient lighting and at sharp angles.

Display of Micrologic measurements and alarms

The FDM121 is intended to display Micrologic 5 measurements, alarms and operating information. It cannot be used to modify the protection settings. Measurements may be easily accessed via a menu.

All user-defined alarms are automatically displayed. The display mode depends on the priority level selected during alarm set-up:

- High priority: a pop-up window displays the time-stamped description of the alarm and the orange LED flashes
- Medium priority: the orange "Alarm" LED goes steady on
- Low priority: no display on the screen

All faults resulting in a trip automatically produce a high-priority alarm, without any special settings required.

In all cases, the alarm history is updated.

If power to the FDM121 fails, all information is stored in the Micrologic non-volatile memory. The data can be consulted via the communication system when power is restored.

Status indications and remote control

When the circuit breaker is equipped with the BSCM module, the FDM121 display can also be used to view circuit breaker status conditions:

- O/F: ON/OFF
- SD: trip indication
- SDE: Fault-trip indication (overload, short-circuit, ground fault)

Main characteristics

- 96 x 96 x 30 mm screen requiring 10 mm behind the door (or 20 mm when the 24 volt power supply connector is used)
 - White backlighting
 - Wide viewing angle: vertical $\pm 60^\circ$, horizontal $\pm 30^\circ$
 - High resolution: excellent reading of graphic symbols
 - Alarm LED: flashing orange for alarm pick-up, steady orange after operator reset if alarm condition persists
 - Operating temperature range -10°C to $+55^\circ\text{C}$
 - CE / UL marking
 - 24 V DC power supply, with tolerances 24 V -20% (19.2 V) to 24 V $+10\%$ (26.4 V)
- When the FDM121 is connected to the communication network, the 24 V is supplied by the communication system wiring system
- Consumption 40 mA

Mounting

The FDM121 is easily installed in a switchboard.

- Standard door cut-out 92 x 92 mm
- Attached using clips

To avoid a cut-out in the door, an accessory is available for surface mounting by drilling only two 22 mm diameter holes.

The FDM121 degree of protection is IP54 in front. IP54 is maintained after switchboard mounting by using the supplied gasket during installation.

Connection

The FDM121 is equipped with:

- A 24 V DC terminal block:
 - Plug-in type with 2 wire inputs per point for easy daisy-chaining
 - Power supply range of 24 V -20% (19.2 V) to 24 V $+10\%$ (26.4 V)
- Two RJ45 jacks

The Micrologic connects to the internal communication terminal block on the Compact NSX via the pre-wired NSX cord. Connection to one of the RJ45 connectors on the FDM121 automatically establishes communication between the Micrologic and the FDM121 and supplies power to the Micrologic measurement functions. When the second connector is not used, it must be fitted with a line terminator.



- 1 Escape
- 2 Down
- 3 OK
- 4 Up
- 5 Context
- 6 Alarm LED

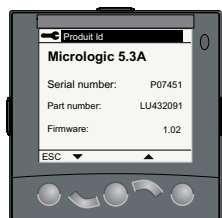

Product identification

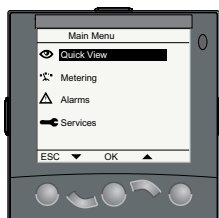

Quick view



Metering: sub-menu

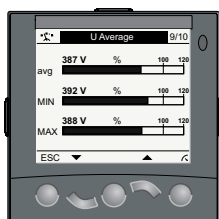

Metering: U average

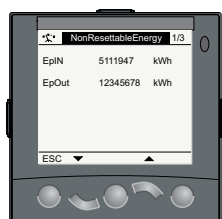

Metering: meter



Services

Navigation

Five buttons are used for intuitive and fast navigation.

The "Context" button may be used to select the type of display (digital, bargraph, analogue).

The user can select the display language (Chinese, English, French, German, Italian, Portuguese, Spanish, etc.) Other languages can be downloaded.

Screens

Main menu

When powered up, the FDM121 screen automatically displays the ON/OFF status of the device.

- Quick view
- Metering
- Alarms
- Services.

When not in use, the screen is not backlit. Backlighting can be activated by pressing one of the buttons. It goes off after 3 minutes.

Fast access to essential information

- "Quick view" provides access to five screens that display a summary of essential operating information (I, U, f, P, E, THD, circuit breaker On / Off)

Access to detailed information

- "Metering" can be used to display the measurement data (I, U-V, f, P, Q, S, E, THD, PF) with the corresponding min/max values
- Alarms displays active alarms and the alarm history
- Services provides access to the operation counters, energy and maximeter reset function, maintenance indicators, identification of modules connected to the internal bus and FDM121 internal settings (language, contrast, etc.)

Selection and order form

Panelboards with the new range of Moulded Case Circuit Breakers (NSX) Installation Monitoring & Measuring functionality all integrated into the MCCB (4 Pole only), with Remote Display (FDM) and Modbus output Compact NSX enable the measured and metered data to be integrated in software management systems.

Note:- 4 pole breakers only on the incommer

Panel board Selection		
Order Code	Description	Selection
400A/630A Panelboard		
MG6C6	18 single pole ways (4 x 4 pole)	<input type="checkbox"/>
MG6C12	36 single pole ways (8 x 4 pole)	<input type="checkbox"/>
MG6C18	54 single pole ways (12 x 4 pole + 2 x 3 pole)	<input type="checkbox"/>
800A Panelboard		
MG8C6	18 single pole ways (4 x 4 pole)	<input type="checkbox"/>
MG8C12	36 single pole ways (8 x 4 pole)	<input type="checkbox"/>
MG8C18	54 single pole ways (12 x 4 pole + 2 x 3 pole)	<input type="checkbox"/>
1600A Panelboard		
MG16C14	42 single pole ways (9 x 4 pole + 2 x 3 pole)	<input type="checkbox"/>
Incomer		
Order Code	Description	Selection
400A/630A Panelboard 4 pole		
SEP400M5M	400A 4 pole MCCB compact NSX Integrated Metering & Monitoring Micrologic 5 Including Metering Cable	<input type="checkbox"/>
SEP630M5M	630A 4 pole MCCB compact NSX Integrated Metering & Monitoring Micrologic 5 Including Metering Cable	<input type="checkbox"/>
800A Panelboard		
MGP8004B5	800A 4 Pole incomer	<input type="checkbox"/>
1600A Panelboard		
33566	1250A 4 pole Incomer	<input type="checkbox"/>
33570	1600A 4 pole incomer	<input type="checkbox"/>
SEPINTP1	Power and interface kit	<input type="checkbox"/>
Outgoing ways 4 pole (only) with Micrologic 5 (Integrated U,I,E,P,f*,THD* Measuring and Monitoring**)		
Order Code	36kA rated circuit breakers	Out going way position
		1 2 3 4 5 6 7 8 9 10 11 12
SEP0404M5	40 A protection module Micrologic 5	<input type="checkbox"/> <input type="checkbox"/> <input type="checkbox"/> <input type="checkbox"/> <input type="checkbox"/> <input type="checkbox"/> <input type="checkbox"/> <input type="checkbox"/> <input type="checkbox"/> <input type="checkbox"/> <input type="checkbox"/> <input type="checkbox"/>
SEP1004M5	100 A protection module Micrologic 5	<input type="checkbox"/> <input type="checkbox"/> <input type="checkbox"/> <input type="checkbox"/> <input type="checkbox"/> <input type="checkbox"/> <input type="checkbox"/> <input type="checkbox"/> <input type="checkbox"/> <input type="checkbox"/> <input type="checkbox"/> <input type="checkbox"/>
SEP1604M5	160 A protection module Micrologic 5	<input type="checkbox"/> <input type="checkbox"/> <input type="checkbox"/> <input type="checkbox"/> <input type="checkbox"/> <input type="checkbox"/> <input type="checkbox"/> <input type="checkbox"/> <input type="checkbox"/> <input type="checkbox"/> <input type="checkbox"/> <input type="checkbox"/>
SEP2504M5	250 A protection module Micrologic 5	<input type="checkbox"/> <input type="checkbox"/> <input type="checkbox"/> <input type="checkbox"/> <input type="checkbox"/> <input type="checkbox"/> <input type="checkbox"/> <input type="checkbox"/> <input type="checkbox"/> <input type="checkbox"/> <input type="checkbox"/> <input type="checkbox"/>
SEP4004M5	400 A protection module Micrologic 5***	<input type="checkbox"/> <input type="checkbox"/> <input type="checkbox"/> <input type="checkbox"/> <input type="checkbox"/> <input type="checkbox"/> <input type="checkbox"/> <input type="checkbox"/> <input type="checkbox"/> <input type="checkbox"/> <input type="checkbox"/> <input type="checkbox"/>
SEP6304M5	630 A protection module Micrologic 5***	<input type="checkbox"/> <input type="checkbox"/> <input type="checkbox"/> <input type="checkbox"/> <input type="checkbox"/> <input type="checkbox"/> <input type="checkbox"/> <input type="checkbox"/> <input type="checkbox"/> <input type="checkbox"/> <input type="checkbox"/> <input type="checkbox"/>
* FDM display required		
** Available via Modbus		
*** 50kA rated breakers		

Metering options (Metering extension Box Required if Fitting Display module)

Order Code	Side Extension boxes	Selection
630A & 800A		
MGPCM6LX	6 Way board Left Hand Side 3 remote display positions	<input type="checkbox"/>
MGPCM6RX	6 Way board Right Hand Side 6 remote display positions	<input type="checkbox"/>
MGPCM12LX	12 Way board Left Hand Side 6 remote display positions	<input type="checkbox"/>
MGPCM12RX	12 Way board Right Hand Side 9 remote display positions	<input type="checkbox"/>
MGPCM18LX	18 Way board Left Hand Side 9 remote display positions	<input type="checkbox"/>
MGPCM18RX	18 Way board Right Hand Side 11 remote display positions	<input type="checkbox"/>
1600A		
MG16CEM4X	Side Extension Cubicle	<input type="checkbox"/>
Display		
TRV00121	FDM121 Metering Display module	<input type="checkbox"/>
Cable accessories		
TRV00870	5 RJ45 female/ female connector	<input type="checkbox"/>
TRV00810	5 RJ45/RJ45 1M interconnector	<input type="checkbox"/>
TRV00820	5 RJ45/RJ45 2M interconnector	<input type="checkbox"/>
TRV00880	10 ULP Line terminators	<input type="checkbox"/>
Modbus Communication accessories		
TRV00210	Modbus interface	<input type="checkbox"/>
TRV00217	Stacking Connector for TRV00210	<input type="checkbox"/>

Standard Outgoing way MCCB (3pole) order codes

Order Code	Description
MGP0163X	PP4 MCCB 3P 16A
MGP0253X	PP4 MCCB 3P 25A
MGP0323X	PP4 MCCB 3P 32A
MGP0403X	PP4 MCCB 3P 40A
MGP0633X	PP4 MCCB 3P 63A
MGP0803X	PP4 MCCB 3P 80A
MGP1003X	PP4 MCCB 3P 100A
MGP1253X	PP4 MCCB 3P 125A
MGP1603X	PP4 MCCB 3P 160A
MGP2003X	PP4 MCCB 3P 200A
MGP2503X	PP4 MCCB 3P 250A
MGP4003X	PP4 MCCB 3P 400A
MGP6303X	PP4 MCCB 3P 630A

Other options

Order Code	Description	
	On site Engineer Support 1 Day	
LV434205	Breaker Status information required (up to 630A)	1 required per Breaker

Example of ordering a Panel Board with Metering

Step 1	Select the Required Panel board from Section 1	MG6C	x1
Step 2	Select Incommer device	SEP630M5M	x1
2a	Select Power & Interface Kit	SEPINTP1	x1
Step 3	Select appropriate outgoing device	SEP1004M5	x1
Step 4	Add Metering accessories		
4a	If you require the display module for each outgoing way then select a side extension box	MGPCM6L	x1
4b	Select required Number of Display Modules (include Incommer)	TRV00121	x3
4c	If data is required over Modbus protocol select the required number of Modbus interfaces (include incomer)	TRV00210	x3
4d	Select modbus stacking connectors (pack of 10) include incommer	TRV00217	x1
4e	Select Required number of RJ45 interconnectors (Pack of 5)	TRV00810	x1
4f	Select ULP terminator (pack of 10)	TRV00880	x1

Note: If no display modules are required and data is to be made available over Modbus only items 4a and 4b are not required.

Safepact 2 **pages 9/2 to 9/3**
Enclosed MCCBs 63 to 630A page 9/2
Enclosed switch disconnectors 100 to 630A page 9/3
Earth leakage page 9/4
Auxiliaries and accessories page 9/5

Enclosed Interpact **page 9/6**

MGF Fusegear **pages 9/7 to 9/9**
Switch disconnector fuse and switch disconnector page 9/7
Fuse switch disconnector and switch disconnector page 9/8
Busbar chambers page 9/9
Accessories page 9/9

Wall mounted switchgear Enclosed MCCBs 63 to 630A



Application

- For use in commercial and industrial applications, providing protection isolation and control of motors and power circuits
- MCCBs can be supplied with adjustable Vigi earth leakage module for improving disconnection times and providing personnel and fire protection
- Suitable for switching inductive loads, AC23 contact rating and high mechanical endurance
- Security of isolation, positive contact indication in accordance with BS 7671 and padlockable rotary handle or toggle padlocking options

Offer

- ASTA certification of breaking capacity to BS EN 60947-2
- Supplied with line and load terminal shields
- Removable front cover provides all round cabling access
- Removable gland plates with optional extension boxes
- Trip indication and test button
- Shrouded disconnectable neutral with 3 pole device
- Steelwork finished in polyester epoxy powder, cream colour RAL9001

Technical data

Enclosure ingress protection	IP42
Rated operational voltage	Ue 415V
Rated current	at 40°C
Rated ultimate short-circuit breaking capacity	Icu = 70kA 2 pole units 85kA@240V
Rated service short-circuit breaking capacity	I _{su} = 100% I _{cu}
Motor ratings	See Section 10
Voltage releases for remote tripping	24 to 415Vac
Auxiliary change over contacts for remote indication	ON, OFF Tripped
Connection accessories for ease of wiring	Cable clamps up to 185/240mm ² optional
Rotary handle provides padlocking and ease of operation	
Earth leakage	30mA to 30A See page 3/4

C-O operations in 000's	100A	160A	250A	400A	630A	
Mechanical endurance	50	40	20	15	15	
Electrical endurance	I _n /2	50	40	20	12	8
	I _n	30	20	10	6	4

Range

MCCB

Rating	Adjustment	Two Pole	3 pole + neutral	4 pole
63A	44 - 63	MGE0632X	MGE0633X	MGE0634X
100A	70 - 100	MGE1002X	MGE1003X	MGE1004X
125A	88 - 125	MGE1252X	MGE1253X	MGE1254X
160A	112 - 160	MGE1602X	MGE1603X	MGE1604X
200A	140 - 200		MGE2003X	MGE2004X
250A	175 - 250		MGE2503X	MGE2504X
400A	160 - 400		MGE4003X	MGE4004X
630A	250 - 630		MGE6303X	MGE6304X

MCCB + earth leakage

Rating	Adjustment	Sensitivity	4 pole
63A	44 - 63	30mA - 10A	MGE0634XE
100A	70 - 100	30mA - 10A	MGE1004XE
125A	88 - 125	30mA - 10A	MGE1254XE
160A	112 - 160	30mA - 10A	MGE1604XE
200A	140 - 200	30mA - 10A	MGE2004XE
250A	175 - 250	30mA - 10A	MGE2504XE
400A	160 - 400	300mA - 30A	MGE4004XE
630A	250 - 630	300mA - 30A	MGE6304XE

Wall mounted switchgear

Enclosed switch disconnectors

100 to 630A



Application

- For use in commercial and industrial applications, providing isolation and control of motors and power circuits
- Devices can be supplied with adjustable Vigi earth leakage module for personnel and fire protection
- Suitable for switching inductive loads, AC23 contact rating and high mechanical endurance
- Security of isolation, positive contact indication in accordance with BS 7671 and padlockable rotary handle

Offer

- Supplied with line and load terminal shields
- Removable front cover provides all round cabling access
- Removable gland plates and optional extension boxes
- Trip indication and test button
- Shrouded disconnectable neutral with 3 pole device
- Steelwork finished in polyester epoxy powder, cream colour RAL9001

Technical data

Enclosure ingress protection	IP42
Rated operational voltage	Ue 415V
Rated current	at 40°C
Voltage releases for remote tripping	24 to 415Vac
Auxiliary change over contacts for remote indication	ON, OFF, Tripped
Connection accessories for ease of wiring	Cable clamps up to 185/240mm ² optional
Rotary handle provides padlocking and ease of operation	
Earth leakage	30mA to 30A See page 3/4

C-O operations in 000's	100A	160A	250A	400A	630A	
Mechanical endurance	50	40	20	15	15	
Electrical endurance	In/2	50	40	20	12	8
	In	30	20	10	6	4

Range

Switch disconnector

Rating	3 pole + neutral	4 pole
100A	MGE1003XS	MGE1004XS
160A	MGE1603XS	MGE1604XS
250A	MGE2503XS	MGE2504XS
400A	MGE4003XS	MGE4004XS
630A	MGE6303XS	MGE6304XS

Switch disconnector + earth leakage (RCCB)

Rating	Sensitivity	4 pole
100A	30mA - 10A	MGE1004XSE
160A	30mA - 10A	MGE1604XSE
250A	30mA - 10A	MGE2504XSE
400A	300mA - 30A	MGE4004XSE
630A	300mA - 30A	MGE6304XSE

Wall mounted switchgear

Earth leakage

Extension boxes



Application

- The vigi earth leakage module option disconnects the circuit breaker when an electrical earth fault is detected
- Used to overcome high earth fault loop impedance and associated excessive disconnection times eg long cable runs
- Enhanced personal and equipment protection

Technical data

Adjustable sensitivity and time delay settings	For discrimination with other RCDs	
Protection against nuisance tripping due to transient overvoltages etc.	To IEC255-4 and IEC801-2 - 5	
Class A	Immunity to DC components of up to 6mA	
Remote indication of tripping	Using optional changeover contact SDV	
Rating	Sensitivity settings (A)	
	Up to 160A	0.03*, 0.3, 1, 3 and 10
	200 - 250	0.03*, 0.3, 1, 3, and 10
	400 - 630	0.3, 1, 3, 10 and 30
Time delay settings (ms)	0, 60, 150 and 310	

* If the sensitivity is set to 30mA there is no time delay whatever the time delay setting. For ordering references see previous pages.

Extension boxes

- Provide extra cabling space when using oversized cables. Colour RAL9001

Size	To fit rating	Part number
100mm	63 - 250A	MGEX160C
200mm	63 - 250A	MGEX250C
120mm	400 - 630A	MGEX630C

Intelligent Safepact

- The Safepact range has now been extended to include our new Micrologic control units up to 630 amp, each unit is supplied complete and ready to install all the customer has to do is connect the supply, load and interface to the modbus system.

Application

- The Individual protection or isolation of loads
- Monitoring of loads with Micrologic 5 control unit
- Separate incomer to distribution equipment
- Replacement to Fuse Switches

Technical data

Ingress protection	IP42
Operational Voltage	415V
Ultimate breaking capacity	70kA
Rated service breaking capacity	100%
FDM module fitted and wired	
Modbus interface, power supply and protection fitted and wired	

Range Reference	Part number
Safepact 4 pole 40A mccb Micrologic 5	MGE0404M5
Safepact 4 pole 100A mccb Micrologic 5	MGE1004M5
Safepact 4 pole 160A mccb Micrologic 5	MGE1604M5
Safepact 4 pole 250A mccb Micrologic 5	MGE2504M5
Safepact 4 pole 400A mccb Micrologic 5	MGE4004M5
Safepact 4 pole 630A mccb Micrologic 5	MGE6304M5



Application

These diagrams show the position of auxiliaries when fitted inside the MCCB or switch disconnecter.

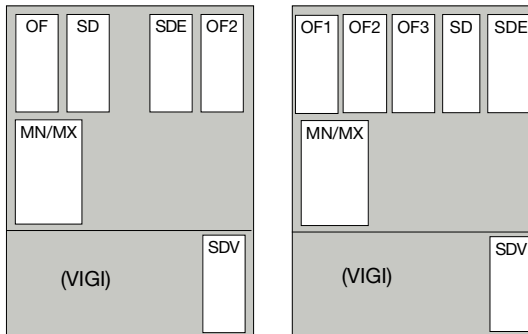

MGE 100/160/250

MGE 400/630



Changeover contact

Auxiliary switch used for remote indication, electrical interlocking etc. Function is dependent upon position fitted within device.

- OF indicates contact position 'ON' and 'OFF'
- SD indicates device is in trip position
- SDE indicates device has tripped due to overcurrent or earth fault (100/160/250 requires SDE adaptor **29451**)
- SDV indicates device has tripped due to earth fault

	Part number
OF/SD/SDE/SDV	29450
SDE adaptor for MGE 100/160/250	29451



Shunt trip (MX)

- Enables remote tripping on application of voltage from coil
- Coil permanently rated

Aux. supply voltage (V)	Part number
220/240	LV429387
380/415	LV429388



Undervoltage release (MN)

- Enables remote tripping on removal of voltage to coil
- Coil permanently rated
- Prevents reclosing of device before restoration of supply to undervoltage release

Aux. supply voltage (V)	Part number
220/240	LV429407
380/415	LV429408



Rotary handle

- Permits the device to be padlocked in OFF position by 1-3 padlocks, 5-8mm hasp
- Maintains indication of ON/OFF and TRIPPED positions
- Maintains access to 'push to trip' button
- Ronis/Profalux keylocks available on 400/630A

	Part number
For MGE 100/160/250	LV429337
For MGE 400/630	LV432597



Cable clamp

- For bare (uncrimped) cable connections
- See technical data for cable terminations in detail
- Other options available: refer to NS catalogue, or consult us

	Part number
For MGE 100/160 up to 95mm ² (set of 4)	LV429243
120 to 185mm ² (set of 4)	LV429260
For MGE 250 25 to 95mm ² (set of 4)	LV429228
120 to 185mm ² (set of 4)	LV429260
For MGE 400/630 up to 2x240mm ² (set of 4)	LV432482



Application

Heavy duty sheet steel enclosures for use in commercial and industrial applications, providing isolation and control of electrical loads. Suitable for switching highly inductive loads without derating. For use in environments where a superior degree of protection is required. Four pole isolation with positive contact indication. Padlockable handle. Alternative red/yellow handle for use in industrial applications. 480V 3 ph 4 wire 50/60Hz systems.

Technical data

Degree of protection	IP55 to BS EN 60529
Sheet steel	Epoxy/polyester powder coated, beige colour
Door interlocked rotary handle	Padlockable
Black handle as standard	With Red/yellow handle option
Removable bottom gland plate	
Switch disconnector manufactured and tested to	BS EN 60947-3
4 pole switching	With fully rated neutral
Rated operational current at AC23A	Nominal rating up to 480V
Rated operational voltage	690V 50/60Hz (500V for 63A)

For further details of the switch disconnectors refer to Interpact catalogue.

Terminations

63A	Clamp connections accepting 1.5 - 16mm ² rigid cable
100 - 630A	Flat pads for crimped lugs

Termination details are identical to those of the Compact MCCBs

References

	Black rotary handle	Red rotary handle with yellow surround
Rating	Part number	Part number
63A	MGES063	MGES063R
100A	MGES100	MGES100R
160A	MGES160	MGES160R
250A	MGES250	MGES250R
320A	MGES320	MGES320R
400A	MGES400	MGES400R
500A	MGES500	MGES500R
630A	MGES630	MGES630R

Accessories

Rating	63A	100-160A	250A	320-630A
Auxiliary switch	29450	29450	29450	29450
Pair long terminal shields	28957	28958	29324	32565
Set of 4 crimp cable lugs for Cu cables c/w 3 phase barriers				
	95mm ²	LV428952		
	120mm ²	LV429256		
	150mm ²	LV429257		
	185mm ²	LV429258		
	240mm ²	LV432501		
	300mm ²	LV432503		

Wall mounted switchgear

Switch disconnecter fuse

Switch disconnecter



Application

Heavy duty fuse products for use in commercial and industrial environments, providing isolation and traditional fuse protection for electrical loads.

Features

- Rated for 240/415V 50/60Hz
- Ratings 20A, 32A, 63A, 100A, SP&SwN, TP&N
- Utilisation category AC20A, AC21A, AC22A, AC23B at rated current
- Degree of protection IP41
- Handle position provides positive contact indication
- Door handle prevents door being opened when switch is ON or padlocked
- Handle padlockable in ON and OFF positions
- Fuse links supplied as standard
- Bottom feed only

Construction

- Live terminals fully shrouded
- Door interlock has integral defeat mechanism allowing door to be opened without switching OFF. This feature is not operable when the handle is padlocked
- Removable gland plates with cable knockouts
- Lift off door provides greater access for installation and cabling
- Door opens within the width of the unit allowing units to be mounted adjacent
- Neutral has disconnectable link and capacity for 3 outgoing cables
- Keyhole slots in the enclosure base allow easy installation
- Earthing kit provided as standard
- Easy access to fuse links
- Steelwork finished in polyester epoxy powder, cream colour RAL9001

Technical data

Standard BS EN 60947-3

Rated operational voltage 415V 50/60Hz

Rating	20A	32A	63A	100A
Rated current at 40°C, A	20	32	63	100
Rated impulse voltage	6kV	6kV	6kV	6kV
Rated short time withstand I _{cw} , A	416	416	756	1300
Rated short circuit making capacity I _{cm}	1.35kA	1.35kA	1.35kA	3.5kA
Rated short circuit breaking capacity I _{cn}	50kA	50kA	50kA	50kA
Utilisation category at rated current	AC-20A/ 21A/ 22A/ 23B			
Kilowatt rating	11kW	15kW	30kW	55kW
Cable size, maximum mm ² (tunnel lug)	10mm ²	10mm ²	25mm ²	50mm ²

References

Rating (A)	Switch disconnecter fuse Part number	Switch disconnecter Part number
Single pole and switched neutral		
20	MGFA0201C	MGFL0201C
32	MGFA0321C	MGFL0321C
63	MGFA0631C	MGFL0631C
100	MGFA1001C	MGFL1001C
Three pole and neutral		
20	MGFA0203C	MGFL0203C
32	MGFA0323C	MGFL0323C
63	MGFA0633C	MGFL0633C
100	MGFA1003C	MGFL1003C

Fuse link data

Rating (A)	BS88 reference	Bussman reference
20	A1, A2	NITD20
32	A1, A2	AA032
63	A2, A3	BA063
100	A2, A3, A4	CEO100

Wall mounted switchgear

Fuse switch disconnecter

Switch disconnecter



Application

Heavy duty fuse products for use in commercial and industrial environments, providing isolation and traditional fuse protection for electrical loads.

Features

- Rated for 240/415V 50/60Hz
- Ratings 100A, 160A, 200A, 250A, 315A, 400A, 500A, 630A TP&N
- Utilisation category AC20A, AC21A, AC22A, AC23B at rated current, AC23A for ratings up to 160A
- Handle position provides positive contact indication
- Door handle prevents door being opened when switch is ON or padlocked
- Handle padlockable in ON and OFF positions
- Device may be fed to either top or bottom terminals
- Fuse links or copper links supplied as standard

Construction

- All terminals are fully shrouded
- Quick make and break silver plated contacts
- Door interlock has defeat mechanism allowing switch to be closed with door open
- Removable plain gland plates are fitted at top and bottom
- Cabling space may be increased by the addition of the cable boxes
- Lift off door provides greater access for installation and cabling
- Door opens within the width of the unit allowing units to be mounted adjacent
- Neutral is fitted with disconnectable link
- Earthing kit provided as standard
- Easy access to fuse links
- Removable cross rails allow cables to be laid in easily
- Direct front access to terminals without dismantling the mechanism
- Clear shrouds allow easy access for inspection and visual indication of contact position
- Steelwork finished in polyester epoxy powder, cream colour RAL9001

Technical data

Standard BS EN 60947-3
 Rated operational voltage 415V 50/60Hz

Rating	100A	160A	200A	250A	315A	400A	500A	630A
Rated current at 40°C, A	100	160	200	250	315	400	500	630
Rated impulse voltage	8kV	8kV	8kV	8kV	8kV	8kV	8kV	8kV
Rated short time withstand I _{cw} , A	3.4kA	3.4kA	5.23kA	5.23kA	12kA	12kA	12kA	12kA
Rated short circuit making capacity I _{cm}	5kA	5kA	8kA	8kA	24kA	24kA	24kA	24kA
Rated short circuit breaking capacity I _{cn}	50kA	50kA	50kA	50kA	50kA	50kA	50kA	50kA
Utilisation category at rated current	AC-23A	AC-23A	AC-23B	AC-23B	AC-23B	AC-23B	AC-23B	AC-23B
Kilowatt rating	55kW	90kW	110kW	130kW	175kW	220kW	250kW	300kW
Terminal stud	M8	M8	M10	M10	M12	M12	M12	M12
Terminal lug, maximum palm width	20mm	20mm	30mm	30mm	50mm	50mm	50mm	50mm
Maximum cable size	50mm ²	50mm ²	120mm ²	120mm ²	400mm ²	400mm ²	400mm ²	400mm ²

References

Rating (A)	Fuse switch disconnecter Part number	Switch disconnecter Part number	Cable box Part number
Three pole and neutral			
100	MGFS1003C	MGFD1003C	MGFX100C
160	MGFS1603C	MGFD1603C	MGFX160C
200	MGFS2003C		MGFX250C
250	MGFS2503C	MGFD2503C	MGFX250C
315	MGFS3153C		MGFX500C
400	MGFS4003C	MGFD4003C	MGFX500C
500	MGFS5003C	MGFD5003C	MGFX500C
630	MGFS6303C	MGFD6303C	MGFX630C

Fuse link data

Rating (A)	BS88 reference	Bussman reference	Cu links (Set of 3)
100	B1	CD100	MGFQ100
160	B2	DD160	MGFQ160
200	B2	DD200	MGFQ250
250	B3	ED250	MGFQ250
315	C1	EF315	MGFQ400
400	C1	EF400	MGFQ400
500	C2	FF500	MGFQ630
630	C2	FF630	MGFQ630



Application

The wall mounting busbar chambers provide an easy means of mounting and interconnecting fusegear products.

Range

Three ratings and three busbar lengths are available. Connection kits enable busbar chambers to be linked and all devices connected to the bars.

Technical data

Manufactured to	BS EN 60439-1
Rated voltage	415V 50/60Hz
Solid copper busbars rated at	200, 400 and 630A
Neutral bar	Fully rated
Busbar chamber lengths	750, 1200 and 1800mm
Chambers dimensions	Common depth (200mm) Common height (450mm)
End plates, top plates and bottom plates	Are fully removable for connections and for access
Steelwork finished	In polyester epoxy powder, cream colour RAL9001

Rating	Length (mm)	Length (mm)	Length (mm)
	750 Part number	1200 Part number	1800 Part number
200	MGFB20007C	MGFB20012C	MGFB20018C
400	MGFB40007C	MGFB40012C	MGFB40018C
630	MGFB63007C	MGFB63012C	MGFB63018C

Busbar connection kits

Each kit comprises connections for three phases and neutral

Rating	Busbar interconnections to link busbar chambers*	Flexible busbar inter connections to link non Schneider Electric busbar chambers	Cable connections to connect to busbars**
	Part number	Part number	Part number
200	MGFK200		MGFC200
400	MGFK400	MGFJ400	MGFC400
630	MGFK630	MGFJ630	MGFC630

* The busbar connection kits allow 2 or more Schneider Electric busbar chambers to be electrically and mechanically joined together providing facilities for a greater number of outgoing circuits.

** The cable connection kits comprise 4 bolts, nuts and washers to connect a set of cables fitted with crimped lugs to the busbars.

Fuse switch connection kits

Each kit comprises connections for three phases and neutral

Rating	Top mounted Part number	Bottom mounted Part number
100, 160	MGFZ160	MGFZ160
200, 250	MGFZ250	MGFZ250
315 - 630	MGFZ630T	MGFZ630

Fuse switch connection kits comprise 4 copper links with connection hardware to connect a fuse switch to the busbars.

Note: the kit required for fitting devices of 315A or greater differs dependent on whether it is mounted above or below the busbar chamber.

Linergy FH **pages 10/5 to 10/7**
Horizontal comb busbar for 18 mm pitch
for Acti 9 / Multi 9 pages 10/2 to 10/3
Horizontal comb busbar for 9 mm pitch
for Acti 9, C60 page 10/4
Horizontal comb busbar for 27 mm pitch
for C120, NG125 page 10/5

Linergy distribution blocks **pages 10/6 to 10/8**

Terminals and installation accessories **pages 10/9 to 10/10**

Powerpact 4 pan assemblies **page 10/11**

Enclosures **pages 10/12 to 10/17**
Mini Opale IP30page 10/12
G9 IP30page 10/12
A-Series IP30page 10/12
B-Series IP31page 12/13
Pragma pages 10/14 to 10/15
Mini Pragma pages 10/16 to 10/17

Kaedra weatherproof IP65 **pages 10/18 to 10/33**
Offer overview page 10/18
Enclosures for sockets page 10/21
Enclosures for modular switchgear page 10/22
Mini enclosures page 10/25
Universal enclosures page 10/27
Interface enclosures page 10/30
Enclosure accessories page 10/32

PB502379-30



IEC 60947-7-1, IEC 61439-2

Description

Comb busbars make it easier to install Schneider Electric products.

- Can be sawn and cut in a single pass
- Supplied with two IP20 lateral end-pieces except for 57 module references
- The end-pieces are compulsory after cutting
- The phases are identified by symbols on each side of the comb busbar for installation in all positions
- Cutting marks on the insulating material
- The special comb busbars for circuit breakers with 9 mm auxiliaries have a 9 mm gap for inserting iOF and iSD

Acti 9 / Multi 9		18 mm poles, cuttable									
Number of poles		1P	2P	3P	4P	Aux+1P	Aux+2P	Aux+3P	Aux+4P	3 (Aux+1P)	3 (Aux+N+1P)
Rated operational current at 40°C	(Ie)	100 A									
Rated conditional short-circuit current of an assembly	(Isc)	Compatible with the breaking capacity of Schneider Electric circuit breakers									
Insulation voltage	(Ui)	500 V									
Rated voltage	(Ue)	415 V									
Fire resistance to IEC 695-2-1		Self-extinguishing 960°C 30 s									
Colour		RAL 7016 (anthracite grey)									
Use											
Power supply by connector recommended											
Type		L1...	L1L2...	L1L2L3...	NL1L2L3...	AuxL1...	AuxL1L2...	AuxL1L2L3	AuxNL1... ...L2L3	AuxL1... ...AuxL2... ...AuxL3	AuxL1... ...AuxL2... ...AuxL3
Set of		1	1	1	1	1	1	1	1	1	1
References											
6 modules of 18 mm		A9XPH106	-	-	-	-	-	-	-	-	-
12 modules of 18 mm		A9XPH112	A9XPH212	A9XPH312	A9XPH412	-	-	-	-	-	-
18 modules of 18 mm		-	-	-	-	-	-	-	-	-	-
24 modules of 18 mm		A9XPH124	A9XPH224	A9XPH324	A9XPH424	-	-	-	-	-	-
57 modules of 18 mm		A9XPH157	A9XPH257	A9XPH357	A9XPH457	A9XAH157	A9XAH257	A9XAH357	A9XAH457	A9XAH657	A9XAH557

Installation

PB110290-20



PB110795-20



Accessories

Number of poles	1P	2P	3P	4P	-	-	
	End-pieces				Tooth covers		Connectors
	Lateral end-pieces providing IP20 protection				Insulate teeth that have been left free		Monoconnect Comb busbar power supply. Horizontal in-coupler on each side. For 35 mm ² cable. Tightening torque 4 N.m
Set of	10	10	10	10	20	4	
References	A9XPE110	A9XPE210	A9XPE310	A9XPE410	A9XPT920	A9XPCM04	

IEC 60947-7-1, IEC 61439-2

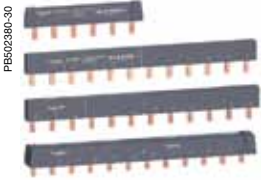

Description

Comb busbars make it easier to install Schneider Electric products. The phases are identified by symbols on each side of the comb busbar. Dismountability of devices with Acti 9.

Acti 9 / Multi 9		18 mm poles, not cuttable				
Number of poles		1P	2P	3P	4P	3 (N+P)
	PB110231-15					
Rated operational current at 40°C (Ie)		100 A				
Rated conditional short-circuit current of an assembly (Isc)		Compatible with the breaking capacity of Schneider Electric circuit breakers				
Insulation voltage (Ui)		500 V				
Rated voltage (Ue)		415 V				
Fire resistance to IEC 695-2-1		Self-extinguishing 960°C 30 s				
Colour		RAL 7016 (anthracite grey)				
Use						
Type		Power supply by connector recommended				
Set of		L1	L1L2	L1L2L3	NL1L2L3	NL1NL2NL3
References		1	1	1	1	1
12 modules of 18 mm		A9XPM112	A9XPM212	A9XPM312	A9XPM412	A9XPM512

Installation



Accessories

	PB110257-10		PB110259-7	
		Tooth covers		Connectors
		Insulate teeth that have been left free		Monoconnect
				Comb busbar power supply
Use				
				Horizontal incomer on each side For 35 mm ² cable Tightening torque 4 N.m
Set of		20		4
References		A9XPT920		A9XPCM04
Installation				





IEC 61439-2



Description

Comb busbars ensure:



- Easy, reliable mounting of 1P+N and 3P+N, TL, CT, ID, V, BP and Cm switchgear: tooth positioning opposite the device terminals is ensured by indexing of copper parts
- C60/ID Group Feeder comb busbars contain two different parts:
 - Connection of Group Feeder switchgear: C60 (3P+N) or ID (3P+N) circuit breaker in 18 mm modules, powered by cables, through the bottom, directly by the terminals
 - Connection of iDPN in 9 mm modules

Acti 9 Ph+N		9 mm poles, cuttable					
Number of poles		1P+N			3P+N		
							
		21501			21505		
		Complete comb busbars (supplied with 4 side plates and 1 tooth cover)					
Rated operational current at 40°C (Ie)		80 A					
Rated conditional short-circuit current of an assembly (Isc)		Compatible with the breaking capacity of Schneider Electric circuit breakers					
Insulation voltage (Ui)		440 V					
Rated voltage (Ue)		230 V (P4 + N) - 400 V (3Ph + N)					
Rated impulse withstand voltage (Uimp)		6 kV					
Degree of protection		IP20					
Fire resistance to IEC 695-2-1		Self-extinguishing 960°C 30 s					
Colour		RAL 7035					
Number of 18 mm modules	Comb busbar	12	18	24	12	18	24
	Tooth cover	3	3	6	3	3	6
References		21501	19512	21503	21505	19516	21507
Comb busbars alone							
Number of 18 mm modules	Comb busbar	48			48		
References		21089			21093		

C60/ID Group Feeder comb busbars alone

Number of poles		3P+N		
				
Rated operational current at 40°C (Ie)		80 A		
Rated conditional short-circuit current of an assembly (Isc)		Compatible with the breaking capacity of Schneider Electric circuit breakers		
Insulation voltage (Ui)		440 V		
Rated voltage (Ue)		230 V (P4 + N) - 400 V (3Ph + N)		
Rated impulse withstand voltage (Uimp)		6 kV		
Degree of protection		IP20		
Fire resistance to IEC 695-2-1		Self-extinguishing 960°C 30 s		
Colour		RAL 7035		
Number of 18-mm modules		12	48	48
Power supply		Through left-hand	Through left-hand	Through right-hand
References		10545	10546	10547

Accessories

Number of poles	1P+N	3P+N		
				
	End-pieces	Tooth covers (3 x 18-mm modules)	Tooth covers (1 x 18-mm module)	Connectors (grey)
Set of	40	12	10	4
References	21094	21095	21096	21098

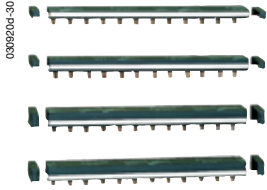

IEC 60664-1

Description

Comb busbars make it easier to install Schneider Electric products.

- Supplied with 2 side plates, IP 2
- Outgoing feeders can be marked
- Cutting markings on the copper bars and the insulating material

C120, NG125		27 mm poles, cuttable			
Number of poles		1P	2P	3P	4P
		Supplied with 2 side plates, IP2 and 4 tooth cover end-pieces Outgoing feeders can be marked Cutting markings on the copper bars and the insulating material Unused teeth can be insulated with tooth covers			
Rated operational current at 40°C	(Ie)	125 A			
Rated conditional short-circuit current of an assembly	(Isc)	Compatible with the breaking capacity of Schneider Electric circuit breakers			
Insulation voltage	(Ui)	620 V			
Rated voltage	(Ue)	500 V			
Fire resistance to IEC 695-2-1		Self-extinguishing 960°C 30 s			
Colour		RAL 7016 (anthracite grey)			
Use					
		Power supply by connector recommended			
Number of 27 mm modules		16	16	15	16
Set of		1			
References		14811	14812	14813	14814

Installation

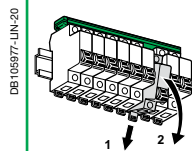

Comb busbars allow dismantability (1-2)

Accessories

Number of poles	1P, 2P, 3P, 4P	
	Tooth covers	Insulated connector
		Compatible with all Schneider Electric comb busbars Clip onto the comb busbar's insulating material, which gives them very great stability Receive clip-on markers allowing circuit identification
Use		
		For 25 mm ² semi-rigid cable
Set of	20	4
References	14818	14885
Installation		

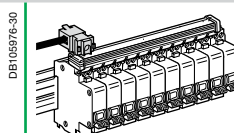
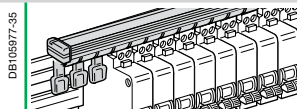



IEC/EN 60947-7-1, IEC/EN 61439-1 & 2

Description

- Single-pole or four-pole distribution block that can be installed on a standard DIN rail or on a mounting plate.
- Compatible with Prisma G and P, Pragma, Mini Pragma and Resbo series switchboards.
- Incomers and feeders are connected to screw terminals that accept rigid or flexible cables with ferrule.
- Optional: additional neutral terminal strip for four-pole distribution block.

Advantages

- Simplified power supply for main incomers.
- Easy phase balancing.
- Easy, effortless cabling due to excellent accessibility.
- Visible cabling.
- Insulation between phases.
- The single-pole distribution blocks are adjacent and bridgeable via the second incoming hole for parallel connection.

Screw distribution blocks

Number of poles	1P			4P
				
Rated operational current	125 A	160 A	250 A	100 A
Total connections capacity	10	13	14	4 x 7
Terminal capacity				
Diameter	2 x Ø9.5 mm	2 x Ø12 mm	1 x Ø15.3 mm	2 x Ø7.5 mm
	2 x Ø7.5 mm	3 x Ø7.5 mm	1 x Ø10 mm	5 x Ø5.5 mm
	6 x Ø5.8 mm	8 x Ø5.8 mm	4 x Ø6 mm	-
	-	-	8 x Ø7.5 mm	-
Rated peak withstand current (I _{pk})	I _{pk} /60 ms: 25 kA	36 kA	60 kA	14 kA
	I _{pk} /6 ms: -	-	-	24 kA
Rated short-time withstand current (I _{cw}) (IEC/EN 60947-7-1)	4.2 kA rms/1 s	8.4 kA rms/1 s	14.4 kA rms/1 s	3 kA rms/1 s
Width (number of 9 mm pitches)	3	4	5	8
Dimension (H x W x D)	85 x 27 x 50.5	85 x 36 x 50.5	85 x 45 x 50.5	100 x 71 x 50.5
Weight (g)	125	163	239	210
Neutral terminal strip (optional)	-	-	-	LGYN1007
References	LGY112510	LGY116013	LGY125014	LGY410028

Technical data

Common characteristics

To IEC/EN 60947-7-1 and IEC/EN 61439-1 & 2

Rated insulation voltage (Ui)	500 V AC
Rated operational voltage (Ue)	230 V AC (L/N) 440 V AC (L/L)
Rated impulse withstand voltage (Uimp)	8 kV
Rated conditional short-circuit current of an assembly	Up to the breaking capacity of Schneider Electric feeder circuit breakers, even in cascading configuration
Network frequency	50/60 Hz
Pollution degree	3
Overvoltage category	III

Additional technical characteristics

Reference temperature	40 °C
Operating temperature	-25 °C to 55 °C
Dielectric withstand (IEC/EN 60947-1)	2500 V AC



On LGY412560 and LGY416048 references.
Input cabling facilitated by side terminals.

125 A			160 A			100 A			125 A			
4 x 12			4 x 15			7			12			
1 x Ø9 mm	1 x Ø9.5 mm	1 x Ø12 mm	2 x Ø7.5 mm	1 x Ø9 mm	1 x Ø9.5 mm	7 x Ø7.5 mm	3 x Ø8.5 mm	3 x Ø9 mm	8 x Ø7.5 mm	-	4 x Ø6.5 mm	11 x Ø6.5 mm
7 x Ø7.5 mm	3 x Ø8.5 mm	3 x Ø9 mm	5 x Ø5.5 mm	7 x Ø7.5 mm	3 x Ø8.5 mm	4 x Ø6.5 mm	11 x Ø6.5 mm	-	-	-	-	-
18 kA	18 kA	22 kA	-	-	-	-	-	-	-	-	-	-
26 kA	28 kA	36 kA	-	-	-	-	-	-	-	-	-	-
4.2 kA rms/1 s	4.2 kA rms/1 s	8.4 kA rms/1 s	-	-	-	-	-	-	-	-	-	-
14	20	18	7	14	17	100 x 126 x 50.5	100 x 162 x 50.5	100 x 174 x 50.5	20 x 70 x 35	20 x 125 x 35	20 x 155 x 35	390
390	559	567	63	111	149	LGYN12512	LGYN12515	LGYN12512	-	-	-	LGYN12515
LGYN12512	LGYN12515	LGYN12512	LGYN1007	LGYN12512	LGYN12515	LGYN12512	LGYN12515	LGYN12512	LGYN1007	LGYN12512	LGYN12515	LGYN12515

Terminal technical data

Type	PZ2 screw							
	Ø5.5 mm	Ø5.8 mm	Ø6 mm	Ø6.5 mm	Ø7.5 mm	Ø8.5 mm	Ø9 mm	Ø9.5 mm
Diameter	Ø5.5 mm	Ø5.8 mm	Ø6 mm	Ø6.5 mm	Ø7.5 mm	Ø8.5 mm	Ø9 mm	Ø9.5 mm
Section rigid cable	1.5 to 16 mm ²	1.5 to 16 mm ²	1.5 to 16 mm ²	1.5 to 16 mm ²	2.5 to 25 mm ²	6 to 35 mm ²	10 to 35 mm ²	10 to 35 mm ²
Section flexible cable or with ferrule	1.5 to 10 mm ²	1.5 to 10 mm ²	1.5 to 10 mm ²	1.5 to 10 mm ²	1.5 to 16 mm ²	4 to 25 mm ²	4 to 25 mm ²	6 to 35 mm ²
Tightening torque	2 N.m	2 N.m	2 N.m	2 N.m	2 N.m	2 N.m	2.5 N.m	2.5 N.m
Type	Hc screw							
	Ø9.5 mm	Ø10 mm	Ø12 mm	Ø15.3 mm				
Diameter	Ø9.5 mm	Ø10 mm	Ø12 mm	Ø15.3 mm				
Section rigid cable	10 to 35 mm ²	1.5 to 50 mm ²	25 to 70 mm ²	35 to 120 mm ²				
Section flexible cable or with ferrule	6 to 35 mm ²	1.5 to 35 mm ²	16 to 50 mm ²	25 to 95 mm ²				
Tightening torque	8 N.m	4 N.m	1P: 9 N.m 4P: 5 N.m	14 N.m				

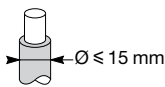

Dimensions (mm)

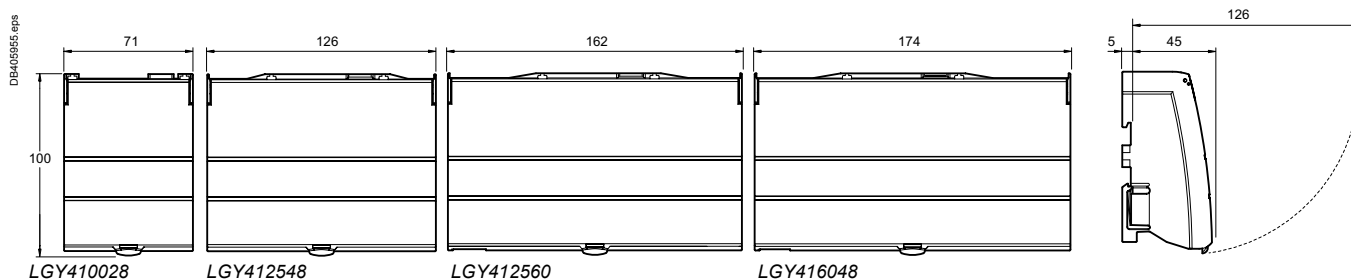
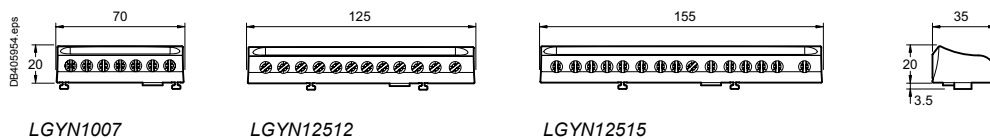
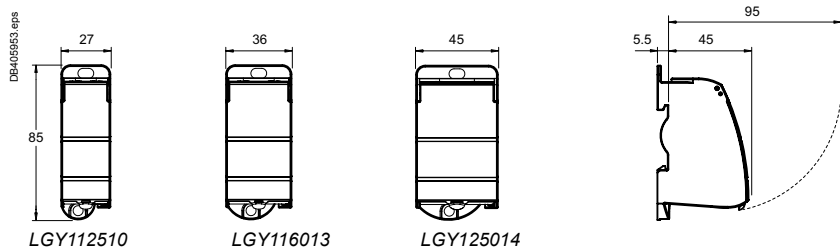



Connection strips 80 - 125A (40°C)

Cross section for stranded cables.

Each strip has one M4 threaded hole for screw attachment to any support.

	Part number
80A connection strip	
4 holes (2 x 10mm ² + 2 x 16mm ²) length 32mm	14962
6 holes (3 x 10mm ² + 2 x 16mm ² + 1 x 35mm ²) length 50mm	14963
10 holes (5 x 10mm ² + 4 x 16mm ² + 1 x 35mm ²) length 74mm	14964
125A connection strip	
14 holes (7 x 10mm ² + 6 x 16 mm ² + 1 x 35mm ²) length 98mm	14965

Terminal block supports

Terminal block support made of self extinguishing insulating material: 960°C/5s. Beige in colour.

Each support can be individually identified using clip-on markers (optional):

- Blue for neutral
- Yellow/green for earth

Fixing:

■ Clipped on to:

- 12 x 2 flat bar
- Multifix or symmetrical rail
- Screwed on to any support (plain or slotted plate) using 2 ears

Cross section for stranded cables

	Part number
80A terminal block	
4 holes (2 x 10mm ² + 2 x 16mm ²) length 68mm	14975
6 holes (3 x 10mm ² + 2 x 16mm ² + 1 x 35mm ²) length 68mm	14976
10 holes (5 x 10mm ² + 4 x 16mm ² + 1 x 35mm ²) length 115mm	14977
125A terminal block	
14 holes (7 x 10mm ² + 6 x 16mm ² + 1 x 35 mm ²) length 115mm	14979



Terminal bar for earth/neutral connections

- For panel mounting
- Including support
- Current rating 200A

Type	Part number
For panel mounting	
1 x 20 holes, length 183mm (19 x 16 ² + 1 x 120 ²)	99217
1 x 25 holes, length 222mm (24 x 16 ² + 1 x 120 ²)	99219
1 x 38 holes, length 332mm (37 x 16 ² + 1 x 120 ²)	99221
1 x 49 holes, length 419mm (48 x 16 ² + 1 x 120 ²)	99223
1 x 73 holes, length 624mm (72 x 16+1 x 120 ²)	99225

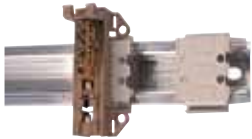

Universal terminal support

This unit can be installed on:

- Symmetrical DIN rail
- Slotted mounting plate
- Asymmetrical DIN rail width: 3 modules of 9mm

Type	Part number
Universal terminal support (pack of 5)	4224

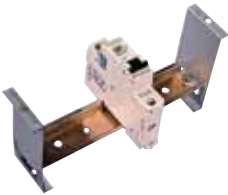

Flush mounting clamp

Allows the installation of all DIN standard devices on an enclosure door. The depth is adjustable by turning the bracket round. DIN rail not included.

Type	Part number
Flush mounting clamp (pack of 4)	20267

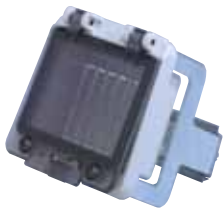

Transparent hinged weatherproof covers for enclosure doors - IP55

Allows the installation of DIN standard devices up to 10 SP ways (twenty 9mm modules) on an enclosure door.

Degree of protection IP55.

- External dimensions (mm): w 235 x h 126 x d 33

- Dimensions of the hole on the door (mm): w 186 x h 96

Supplied with a blanking plate (to cover up to ten 9mm modules) and fixing and drilling template.

Type	Part number
Transparent hinged cover (10 x 18mm ways)	14210
DIN rail support (and fixing)	14211
Transparent hinged cover (4 x 18mm ways)	99246A
Transparent hinged cover complete with DIN support bracket (4 x 18mm ways)	99246B

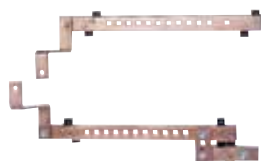
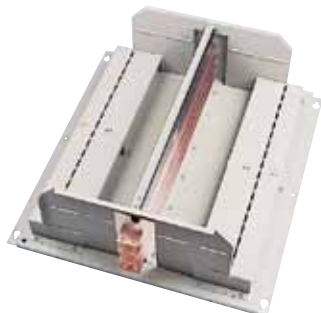

Outgoing pan assembly 630A or 800A busbar ratings

Application

Pan assemblies provide easy to connect high density connection independent of device mix for mounting of moulded case circuit breakers into a low voltage power distribution switchboard. Can be fed from the side or bottom fed using incoming pan assembly. For technical data see Section 2.

SP ways	Part number	
	630A busbar	800A busbar
18	MG6PAC6	MG8PAC6
36	MG6PAC12	MG8PAC12
54	MG6PAC18	MG8PAC18
72	MG6PAC24	MG8PAC24
90	MG6PAC30	MG8PAC30

See Section 8 for outgoing and incoming devices

Incoming pan assembly 630A or 800A busbar ratings

Application

Incoming section including mounting tray metal shroud and copper busbar 'T' section to allow cassetted breakers to feed pan from bottom.

Current rating (A)	Part number	
	3P	4P
630	MG6PACN	MG8PACN
800	MG8PACN3	MG8PACN4

18 way neutral bar kit

Mounts on either side of incoming device when using incoming pan assembly. Includes disconnectable neutral link.

Type	Part number
630A	MG6PANKIT
800A	MG8PANKIT

Front cover (up to 18TP ways only)

Number of outgoing ways	TP	Part number	
		630A interior	800A interior
SP			
18	6	MG6PAFC6	MG8PAFC6
36	12	MG6PAFC12	MG8PAFC12
54	18	MG6PAFC18	MG8PAFC18

Note: If RCD, metering, remote metering or 400/630A outgoing devices are fitted then a shrouding kit must be used.

Shrouding kit (with MG6 FC front covers only)

Provides additional support for device and shrouding for front cover .One shrouding kit must be used per side when fitting either outgoing 400/630AMP MCCBs or outgoing ammeter and/or earth leakage protection. In addition to the shrouding kit an addition a 25mm three stage filler piece is required when 4 pole 400A or 630AMP circuit breakers are fitted on the outgoing pan assembly MGPTSF25.

Number of outgoing ways	Shrouding kit TP	Part number
SP		
18	6	MGPCH6
36	12	MGPCH12
54	18	MGPCH18

Mini Opale IP30

G9 IP30

A-Series IP30



Mini Opale enclosures (IP30)

Mini Opale enclosures are all insulated and made of an impact resistant material which is self extinguishing to 650°C. Degree of protection: IP30

They consist of:

- An insulated back plate incorporating a DIN rail
- A cover clipped to the back plate
- Two 4 hole terminal bars built in, 13396 and 13398 only. (1 X 16mm² + 3 X 10mm²)

Installation

- Wall mounting, 2 or 4 screws supplied.

SP 18mm ways	Size (mm) H - W - D	Part number 18mm
2	130 x 44 x 57	13392
4	130 x 80 x 57	13394
6	160 x 119 x 65	13396
8	160 x 155 x 65	13398

Suitable for most DIN standard devices



G9 enclosures (IP30)

These enclosures are made from pressed sheet steel, epoxy powder coated. Colour: RAL 9001. Degree of protection: IP30.

They consist of:

- A back plate with DIN rail
- A cover, screwed to the back plate, having 25mm knockouts top and bottom

Installation

- Wall mounting

SP 18mm ways	Size (mm) H - W - D	Part number 18mm
3	200 x 101 x 63	99560
4	250 x 122.5 x 63	14599
5	250 x 122.5 x 63	14603

Suitable for most DIN standard devices



A series enclosures (IP 30)

These enclosures are made from folded sheet steel, epoxy powder coated. Colour: RAL 9001. Degree of protection: IP3X.

They consist of:

- An enclosure having a back plate with DIN rail 25mm knockouts in top, bottom, sides and rear of enclosure built-in earth terminal bar
- A cover having a left handed hinged door with plastic latch

Installation

- Wall mounting

SP 18mm ways	Dimensions (as)	Part number
8	SEA9AN6	SEA9DE16
12	SEA9AN10	SEA9DE24
16	SEA9AN14	SEA9DE32
20	SEA9AN18	SEA9DE40
32	SEA9AN27	SEA9DE64*

* 2 row

Accessories

Key lock	SEA9BL
----------	--------



Application

These enclosures are designed to accommodate DIN rail mounted products, primarily for control and metering. They may be mounted individually or attached to the side of an MGB board of equivalent height using the side joining kit MGBNSJK. For mounting above and below a standard B board use ref MGBNTJKN.

Technical data

Ingress protection:	IP30 to BS EN 60529
Earth bar capacity:	25mm ²
Mounting:	Surface
Colour:	RAL 9001 epoxy powder coated



Supplied with DIN rail, door and slotted front cover

Part number	Capacity in 18mm SP ways	Number of rows	Dimensions in mm		
			Height	Width	Depth
SEA9BN4SXS	34	2	484	470	138
SEA9BN8SXS	34	2	538	470	138
SEA9BN12SXS	51	3	700	470	138
SEA9BN16SXS	68	4	862	470	138
SEA9BN24SXS	85	5	1024	470	138



Supplied with DIN rail, door and plain front cover

Part number	Capacity in 18mm SP ways	Number of rows	Dimensions in mm		
			Height	Width	Depth
SEA9BN4SXP	34	2	484	470	138
SEA9BN8SXP	34	2	538	470	138
SEA9BN12SXP	51	3	700	470	138
SEA9BN16SXP	68	4	862	470	138
SEA9BN24SXP	85	5	1024	470	138

Suitable for most DIN standard devices

Installation

- Wall mounting
- Flush mounting kit available



24 module enclosures



13 module enclosures



Customisable transparent door



Modular terminal blocks with screwless quick connections for small cables - earth and neutral terminal blocks



Neutral terminal blocks easy to split to adapt to earth leakage protection

Function

A range of ready-to-install enclosures devised for electricians: ergonomics and flexibility of installation. The Pragma offer is particularly robust, especially the 24-module enclosures thanks to their metal structure and their reinforced front face.

Application

This distribution enclosure is intended for top of the range residential and tertiary sectors. The 24-module enclosures can accommodate the NG125 incoming circuit breaker or switch, equipped if necessary with an earth leakage protection module.

Technical data

13 module enclosures technoplastic⁽¹⁾, metal grey and titanium white

24 module enclosures: metal and technoplastic⁽¹⁾, metal grey and titanium white

Transparent doors:	For 13 module enclosures: technoplastic ⁽¹⁾ , crystal
	For 24 module enclosures: metal and glass, titanium white and crystal

Opaque doors:	For 13 module enclosures: technoplastic ⁽¹⁾ , titanium white
	For 24 module enclosures: metal, titanium white

Withstand fire and abnormal heat at 650 °C as per IEC 60695-2-11/EN 60695-2-11

Total insulation class II: Conform to IEC 60439-3/EN 60439-3 § 7.4.3.2.2.

Advantage: Thanks to its design, the entire Pragma range has "total insulation": no components on the enclosure, interface or door need be earthed.

Degree of protection as per IEC 60529:	Without door: IP30
--	--------------------

	With door: IP40
--	-----------------

Degree of protection against mechanical impacts as per IEC 62262:	Without door: IK08
---	--------------------

	With door: IK09
--	-----------------

Operating temperature:	-25 °C to +60 °C.
------------------------	-------------------

(1) Technoplastic material specially developed by Merlin Gerin.

Components delivered with each enclosure and interface

Marking strips + label-guard

Blanking plate strip

Earth and neutral terminal blocks:	See part number table
------------------------------------	-----------------------

Identification label

Front face and back connection

1 plain plate per row

Enclosures												Part number
Number of modules per row	Number of rows	Capacity in modules of 18mm	Rated current In	Neutral terminal block				Earth terminal block				Without door
				Number of connections				Number of connections				
				Total	50°	25°	6°	Total	50°	25°	6°	
13 modules	1	13	63 A	11	-	3	2 x 4	13	-	1	3 x 4	PRA20113
	2	26	63 A	19	-	3	4 x 4	17	-	1	4 x 4	PRA20213
	3	39	90 A	23	-	3	5 x 4	22	-	2	5 x 4	PRA20313
	4	52	90 A	27	-	3	6 x 4	26	-	2	6 x 4	PRA20413
24 modules	1	24	125 A	23	1	2	5 x 4	22	1	1	5 x 4	PRA20124
	2	48	125 A	29	1	4	6 x 4	27	1	2	6 x 4	PRA20224
	3	72	160 A	29	1	4	6 x 4	27	1	2	6 x 4	PRA20324
	4	96	160 A	35	1	6	7 x 4	32	1	3	7 x 4	PRA20424

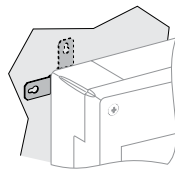

External wall mounting lugs

Accessories	
Mounting in interfaces	Part Number
External wall mounting lugs	PRA90009
Door lock - key 405	PRA90039
13 module blank	PRA91020

Door for enclosures			
Mounting in interfaces		Customisable transparent	Opaque
		Part Number	Part Number
13 modules	1 row	PRA15113	PRA16113
	2 rows	PRA15213	PRA16213
	3 rows	PRA15313	PRA16313
	4 rows	PRA15413	PRA16413
24 modules	1 row	PRA15124	PRA16124
	2 rows	PRA15224	PRA16224
	3 rows	PRA15324	PRA16324
	4 rows	PRA15424	PRA16424

A range of 18 mm, 1, 2 or 3-row 4, 6, 8, 12, 18, 24 or 36-module ready-to-use enclosures designed for electricians: ergonomic design and flexibility of installation.

Function

This distribution or sub-distribution enclosure, up to 63 A, is designed for installing electrical switchboards in new or renovated installations in the housing sector.

Description

The surface mounting Mini Pragma consists of:

- a back with:
 - a centered slot to facilitate installation
 - fixing holes for vertical adjustment.
 - the necessitate for entry cables:
 - two removable cable entry plates at the top and bottom
 - punch-outs
 - a large area for drilling (crown saw, punches)
 - 1 to 3 DIN rails fixed asymmetrically onto the back
 - a reversible front face, fitted with pre-cutout blanking plates
 - a white opaque or translucent door or smoked transparent
 - an earth terminal block and a neutral terminal block
- Enclosure colour: White RAL 9003.

This enclosure can be equipped with a marker light, available in accessories. It allows locating the enclosure in the dark during a power failure.

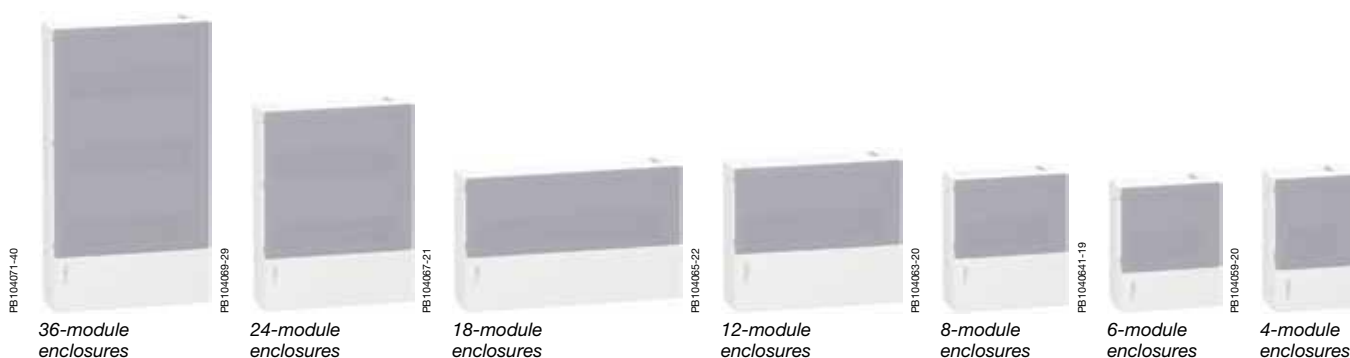

Smoked translucent door.



White door.

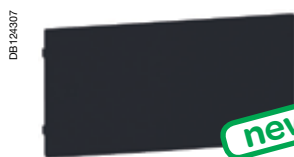

Smoked transparent door.

Technical data

Enclosures		
Compliance with standards	IEC 60439-3, IEC 60529, IEC 60695-2-11, EN 50102, IEC 60670-24	
Rated current (In)	4-module enclosure	50 A
	6 to 36-module enclosures	63 A
Rated insulation voltage (Ui)	< 400 V	
Insulation	Class 2 (as per IEC 60439-3)	
Degree of protection	To IEC 60529	IP 40
	Against mechanical impacts	IK 07
Materials	Self-extinguishing technoplastic ⁽¹⁾ : resistant to fire and abnormal heat 650°C to IEC 60695-2-11	

(1) Technoplastic material specially developed by Schneider Electric.

Catalogue numbers

White enclosures				Cat. no.
Number of rows	Number of modules per row	Capacity in 18 mm modules	Rated current In (A)	With solid white door
1	4	4	50	MIP12104
	6	6	63	MIP12106
	8	8	63	MIP12108
	12	12	63	MIP12112
	18	18	63	MIP12118
2	12	24	63	MIP12212
3	12	36	63	MIP12312

Components delivered with each enclosure

Type		
Insulating plug (pack of 4)		To be placed over the back fixing screws to obtain class 2 insulation
Identification strip for each row		To be glued onto the front panel
Two terminal block supports		
Two earth/neutral terminal blocks	Supplied with the 4 or 6-module enclosure	$2 \times (1 \times 16^{\square} + 2 \times 10^{\square} + 1 \times 6^{\square})$
	Supplied with the 8 or 12-module enclosure	$2 \times (1 \times 16^{\square} + 4 \times 10^{\square} + 3 \times 6^{\square})$
	Supplied with the 18 or 24-module enclosure	$2 \times (2 \times 16^{\square} + 8 \times 10^{\square} + 6 \times 6^{\square})$
	Supplied with the 36-module enclosure	$2 \times (2 \times 16^{\square} + 9 \times 10^{\square} + 9 \times 6^{\square})$

Accessories

Type		Cat. no.
Removable plate (pack of 2)	4 modules	MIP99029
	6 modules	MIP99030
	8 modules	MIP99031
	12 modules	MIP99032
	18 modules	MIP99033
Surface mounting IP41 kit		MIP99034
Terminal block support (pack of 2)	18 modules	MIP99036
Terminal block	$1 \times 16^{\square} + 2 \times 10^{\square} + 1 \times 6^{\square}$	MIP99037
	$1 \times 16^{\square} + 4 \times 10^{\square} + 3 \times 6^{\square}$	MIP99038
	$2 \times 16^{\square} + 8 \times 10^{\square} + 6 \times 6^{\square}$	MIP99039
	$2 \times 16^{\square} + 9 \times 10^{\square} + 9 \times 6^{\square}$	MIP99040
Earth terminal block	$3 \times 16^{\square} + 12 \times 2.5^{\square}$	13409
	$4 \times 16^{\square} + 20 \times 2.5^{\square}$	13410
Ph+N insulated terminal block (pack of 2)	$2 \times (1 \times 35^{\square} + 5 \times 16^{\square})$	13411
	$2 \times (1 \times 35^{\square} + 7 \times 16^{\square})$	13412
Blanking plate	5 modules	13387
Symbol plate	Standard	13735
	Special	13736
Keylock		MIP99046



Insulating plug



MIP99030



MIP99034



The most comprehensive enclosure range

- Enclosure for modular switchgear
- Enclosures for modular switchgear with interface
- Enclosures for power outlets
- Universal enclosures

For the production of electrical switchboards incorporating protection, control and distribution

- Modular protection devices
- Power outlets
- Pushbuttons and indicator lights, etc
- Non-modular switchgear (transformer, motor control, etc.)

For tertiary, small contracting and industrial sectors

For environments requiring optimum protection of persons and electrical switchgear.

Safety

Kaedra switchboards guarantee a high degree of protection and increased dependability thanks to:

- Their degree of protection (IP65)
- Their high impact strength (IK09) and resistance to chemical and atmospheric agents, UVs, etc
- Class 2 insulating material
- Optional locking of the door and sealing of the front face and front plates
- Conformity with IEC 670 standard for empty enclosures and with IEC 439-3 standard for equipped boards

Ergonomics

Kaedra switchboards offer remarkable cabling space.

Both the cable inlet and internal distribution is simplified.

The transparent doors enable permanent, immediate checking of operating conditions. The interface zones offer quick access to power outlets and control devices. The functional openings allow rapid installation of all devices directly or using matching plates. The frame and all its possibilities guarantee assembly time savings.

Attractive design

Their modern, rounded shape, result of in-depth design and ergonomic studies, make the Kaedra switchboards ideal for use even in places visible to the general public. Their innovating colours ensure enhanced integration, while at the same time guaranteeing the basic requirements of visibility and inspection of switchgear.



10

Enclosures for modular switchgear

Available in 7 versions from 3 to 72 modules. They allow installation of modular switchgear up to 125 A, as well as non-modular switchgear on slotted mounting plate.

Enclosures for modular switchgear with interface

Available in 3 versions of 12, 24 and 36 modules. The interface zone offers the possibility, thanks to the functional plates, of installing on the switchboard front face, control or protection devices, indicator lights and PK series power outlets of the domestic or industrial type.

Interface enclosures

Available in 2 versions with 2 or 3 openings. They can be used by themselves, horizontally or vertically, or associated with other enclosures as cable trunking or interface zone (control devices, indicator lights, power outlets, etc.).

Universal enclosures, Available in 5 sizes. They are designed for production of control and monitoring switchboards with non-modular type devices.

Enclosures for power outlets

90 x 100 mm openings. Available in versions with 1 to 8 openings.

They are characterised for the new functional feature with openings allowing installation of all PK power socket outlets or the incorporation of control and indicator light functions.

103 x 225 mm opening, Available in versions with 1 to 4 openings.

They can accommodate the new PK Unika interlockable power outlets.

Universal

Available in 5 sizes.

They allow mounting of flush-mountable power socket outlets up to 125 A.

Range of weatherproof mini enclosures

1 row









Part number	13175	13176	13177	13975	13441	13442	13443	13444
Number of modules	4	4	4	3	4	6	8	12
Width	98	98	98	80	123	159	195	267
Height	248	310	392	150	200	200	200	200

Range of weatherproof enclosures

mm	138 5 modules	236 8 modules	340 12 modules per row	12 + 1 modules	448 18 modules per row (12 modules if interface)	18 + 1 modules
280			13981 		13982 13990 	
335				13180 13191 		
460	13178 13993 	13179 	13983 	13181 13195 	13984 	13182 13197
	13185 13189 	13186 13190 		13187 13192 	13991 	13188 13193
610	13994 		13985 	13196 	13986 13992 	13198
842					13987 	13199

Enclosures offering:

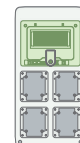
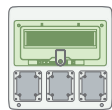
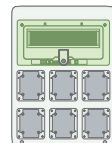
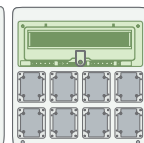
- A zone for industrial or domestic power outlets, buttons or indicator lights
- A row for modular switchgear power outlets

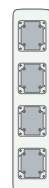
	Mini enclosures			Enclosures					See page 6/28	
Number of modules	4	4	4	5	8	12+1	12+1	18+1	0	0
										
	13175	13176	13177	13178	13179	13180	13181	13182	13993	13994

Technical data

Self-extinguishing insulating material	
Operating temperature:	-25°C to +60°C
Colour:	Light grey RAL 7035 and transparent green wicket gate
IP65	As per IEC 60529
IK09	As per EN 50102
Class 2:	Total insulation
Flame and abnormal heat resistance:	650°C as per IEC 60695-2-1
Complies with standard	IEC 60439-3
Resistance to chemicals and atmospheric agents	

Enclosures part numbers

Data		Pre-cutout (top and bottom) ⁽¹⁾						Dimensions (mm)			Accessories delivered with an enclosure part number ⁽²⁾				Part No.					
Total mod.	open	M	16	20	25	32	50	W	H	D	Wiring strap	Terminal block support	Terminal block number of holes			Plates Part number				
		PG		11	16	21	29/36						4	8	16	13135	13136	13138	13143	
Mini enclosures for power outlets (65 x 85 mm openings)																				
4	1				1			98	248	98.5										13175
4	2				1			98	310	98.5						1				13176
4	3				1			98	392	98.5						1				13177

Enclosures for power outlets (90 x 100 mm openings)																					
5	2			1	1	1		138	460	160				1				2	1		13178
8	4			2	2	3		236	460	160	2	1		1				4	1		13179
12+1	3		6	6	2	3		340	335	160	2	1		1				3	1		13180
12+1	6		6	6	2	3		340	460	160	2	1		1				6	2		13181
18+1	8			10	4	2	1	448	460	160	2	1		1		1		8	2		13182

Enclosures for interlocked power outlets (103 x 225 mm openings)																					
5	1			1	1	1		138	460	160				1							13185
8	2			2	2	3		236	460	160	2	1		1						1	13186
12+1	3		6	6	2	3		340	460	160	2	1		1						1	13187
18+1	4			10	4	2	1	448	460	160	2	1		1						1	13188



(1) Concentric pre-cutouts of the PG and ISO/metric type (EN 50262).

(2) Accessories also delivered:

- Mini enclosures: class II plugs
- Enclosures: class II plugs, blanking plates (5 modules of 18 mm per row) and a marking kit

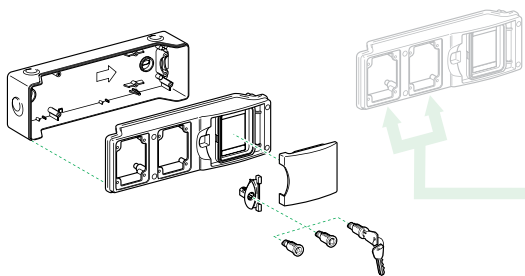

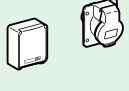
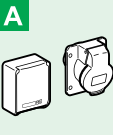
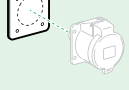



Mini enclosures with 65 x 85 mm openings

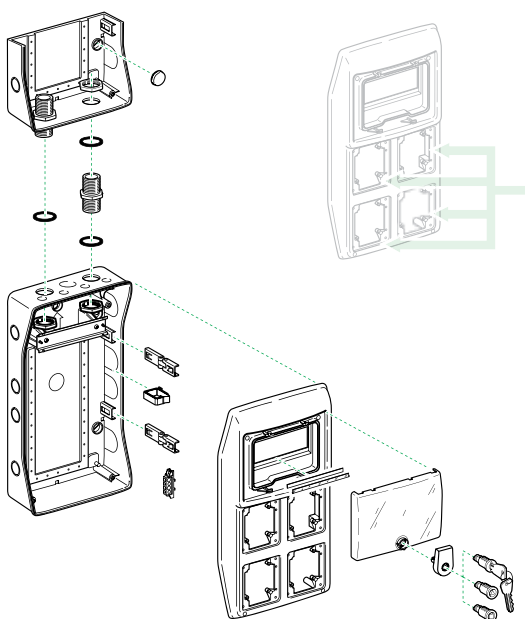

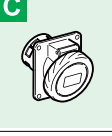
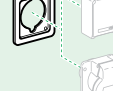
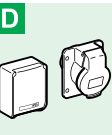
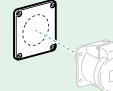
	Direct mounting		Domestic and LV power outlets (65 x 85 mm).
	With plate Part no. 13135		Power outlets (50 x 50 mm).

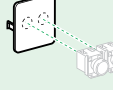



Enclosures with 90 x 100 mm openings

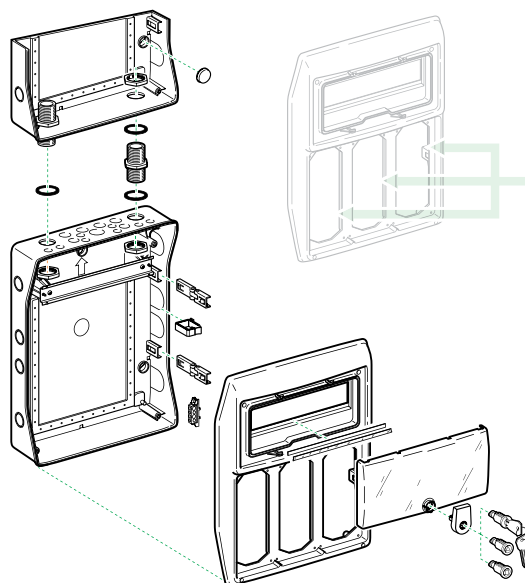

	Direct mounting		16/32 A slanting power outlets (90 x 100 mm).
	With plate Part no. 13136		Domestic and LV power outlets (65 x 85 mm).
	With plate Part no. 13137		LV and ELV power outlets (65 x 65 mm and 75 x 75 mm).
	With plate Part no. 13138		Buttons, indicator lights and switches 16 and 22 mm diameter.
	With plate Part no. 13141		Identification label.

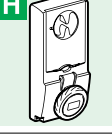
Enclosures with 103 x 225 mm openings

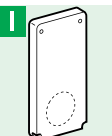
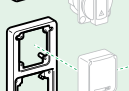
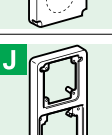

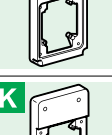
	Direct mounting		Power outlet interlocked or with safety transformer.
	With plate Part no. 13143		Blanking and adaptation plate to be drilled for 65 x 65 mm or 75 x 75 mm power outlet.
	With plate Part no. 13142		Plate with 2 openings: ■ 65 x 85 mm ■ 90 x 100 mm.
	With plate Part no. 13144		63 A LV power outlet (100 x 107 mm).

Enclosures for modular switchgear with interface

Kaedra



Enclosure offering:

- An interface zone always available for user and that can accommodate buttons, indicator lights, power outlets or modular switchgear
- A zone, behind the door, to install the modular switchgear

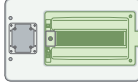
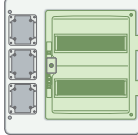
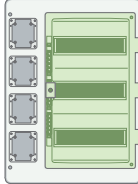
Number of modules	12	24	36
	1	3	4
			
	13990	13991	13992

Mechanical data

Self-extinguishing insulating material

Reversible front face Interface zone to the left or right. It is also an excellent cable duct
 Door opening in either direction

Inside depth available for installation of non-modular switchgear between the slotted mounting plate and the plain front plate: 100 mm

In enclosures with 3 or 4 openings, the kit for INS40/63/80 A must be mounted in the central openings

Technical data

Self-extinguishing insulating material

Operating temperature: -25°C to +60°C

Colour: Light grey RAL 7035 and transparent green door

IP65 As per IEC 60529

IK09 As per EN 50102

Class 2: Total insulation

Flame and abnormal heat resistance: 650°C as per IEC 60695-2-1

Complies with standard IEC 60439-3

Resistance to chemicals and atmospheric agents

Enclosures for modular switchgear with interface Kaedra

Enclosures part numbers

Data										Accessories delivered with an enclosure part number ⁽²⁾														
Row	Total mod.	Slot for plate	Pre-cutout (top and bottom) ⁽¹⁾					Dimensions (mm)			marking kit	wiring strap	Terminal block support	Terminal block number of holes					Plates for buttons, indicator lights 13138	65x85mm power outlet 13136	Part number			
			M PG	20 11	25 16	32 21	50 29/36	W	H	D				4	8	16	22	32						
1	12	1		10	4	2	1	448	280	160	1	1	1	1	1	1	1	1	1	1	1	1	1	13990
2	24	3		10	4	2	1	448	460	160	2	2	1	1	1	1	1	1	1	1	1	1	1	13991
3	36	4		10	4	2	1	448	610	160	3	3	1	1	1	1	1	1	1	1	1	1	1	13992

(1) Concentric pre-cutouts of the PG and ISO/metric type (EN 50262)

(2) Accessories also delivered: class II plugs and blanking plates (5 modules of 18 mm per row)

Part numbers of the main accessories

Name	Description	Part number
Association kit	2 sleeves + 4 nuts	13934
Wall mounting lugs		13935
Slotted mounting plate		13941
Plain front plate	12 modules	13944
Interface plate for	65 x 85 power outlets	13136
	65 x 65 or 75 x 75 power outlets	13137
	Pushbutton controls	13138
	Identification	13141
Interface kit	INS40/63/80 A	13139
	Modular switchgear up to 4 modules (e.g. residual current circuit breaker)	13140
Wiring strap		13946
Sealing kit		13947
Keylock		13948
Insert	Triangle	13949
	Square	13950

Other accessories available for these enclosures:

Row separator, jack-up block, junction for trunking, blanking plate, terminal block support, insulated terminal blocks, IP2 covers, cable support sleeves, cable gland, self-adhesive symbols, self-adhesive sheets.

Enclosures for modular switchgear with interface

Kaedra

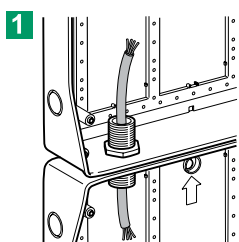
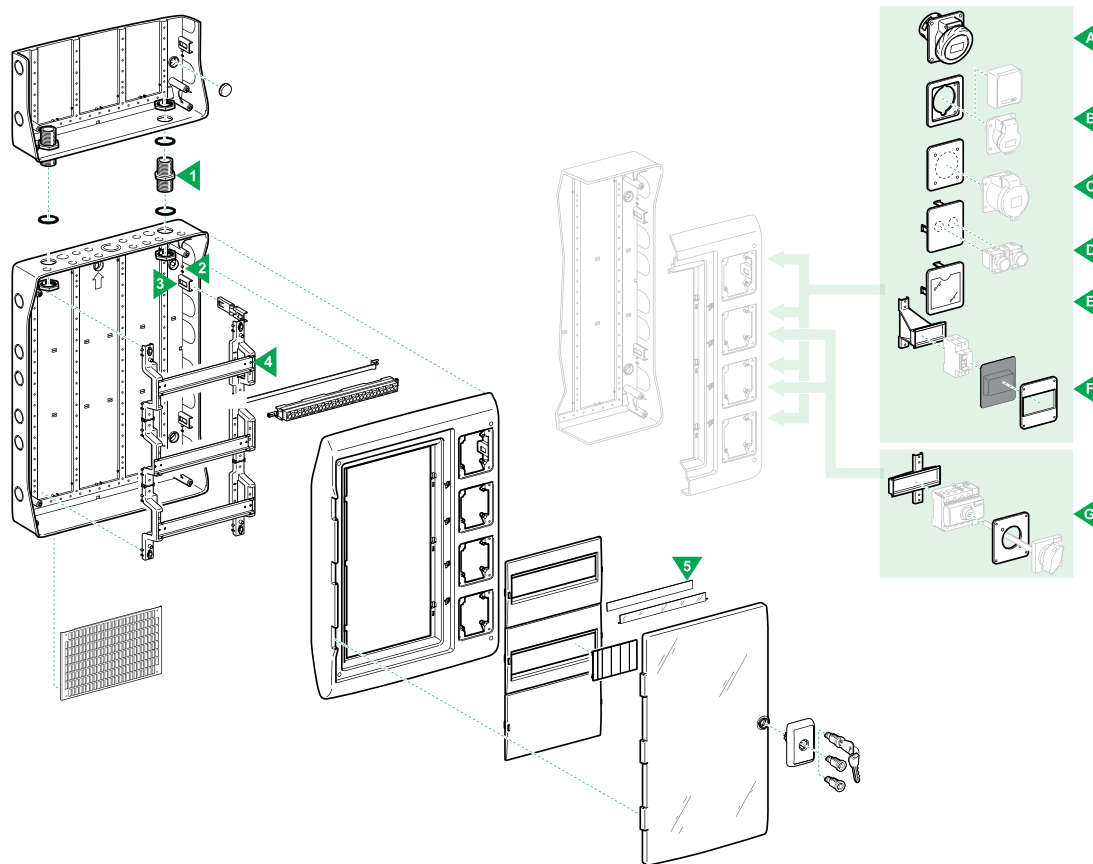

1 Add-on possibility
Enclosures can be horizontally or vertically associated keeping the IP65 and allowing cable insertion.

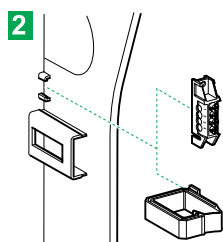

2 Dovetails
Arranged on the back and on the chassis, they can accommodate:
■ 4-hole terminal blocks
■ Wiring straps

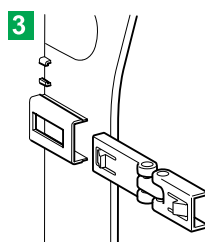

3 Back/front face hinges
Clipped onto the right or left, they simplify cabling and working on the interface zone.

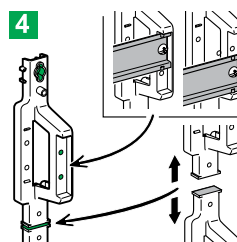

4 Chassis
■ DIN symmetrical rails positionable in 2 depths and 2 heights to privilege cabling room
■ Chassis that can be severed to install a mounting plate on the back

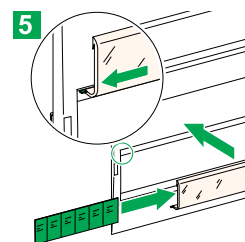

5 Marking
Clip-on label covers ensure neat, quick and upgradeable marking.

10

Everything for the interface

Direct mounting

With plate
Part no 13136

With plate
Part no 13137

With plate
Part no. 13138

With plate
Part no 13141

With kit
Part no 13140

With kit
Part no 13139



16/32 A slanting power outlets (90 x 100 mm).

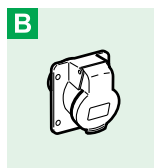

LV power outlets (65 x 85 mm).

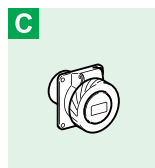

LV and ELV power outlets (65 x 65 mm and 75 x 75 mm).

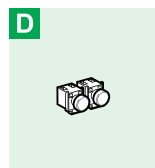

Buttons, indicator lights and switches 16 and 22 mm diameter.



Identification label

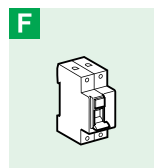

Modular switchgear up to 4 modules (e.g. residual current circuit breaker).

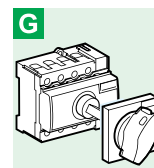

INS40/63/80 A.

Enclosures and mini enclosures for modular switchgear

Kaedra

3 to 12 module mini enclosures, economic and compact.
Add-on 12 to 72 module enclosures.



Kaedra enclosures and mini enclosures for modular switchgear.

Mini enclosures				
Nbr of modules	4	6	8	12
1 row				
	13441	13442	13443	13444
Enclosures				
Nbr of rows	1	2	3	4
12 modules				
	13981	13983	13985	
18 modules per row				
	13982	13984	13986	13987

Enclosure part numbers

Data										Accessories with an enclosure catalogue number ⁽²⁾							Part No.			
Row	Total mod.	Pré-cutout (top and bottom) ⁽¹⁾							Dimensions (mm)			Marking kit	Wiring strap	Terminal block support	Terminal block number of holes					
		M PG	16	20	20 11	25 16	32 21	50 29/36	W	H	D				4	8	16	22	32	
Mini enclosures																				
1	4	1	1		1			123	200	112	1		1	2				13441		
	6	1	1		1			159	200	112	1		1	2				13442		
	8	2	2		1			195	200	112	1		1	4				13443		
	12	2	2		2	1		267	200	112	1		1	2				13444		
Enclosures																				
1	12	6		6	2	3		340	280	160	1	1	1	1	1			13981		
	18			10	4	2	1	448	280	160	1	1	1	1	1			13982		
2	24	6		6	2	3		340	460	160	2	2	1	1		1		13983		
	36			10	4	2	1	448	460	160	2	2	1	1			1	13984		
3	36	6		6	2	3		340	610	160	3	3	1	1			1	13985		
	54			10	4	2	1	448	610	160	3	3	2	1		2		13986		
4	72			10	4	2	1	448	842	160	4	4	2	1			2	13987		

⁽¹⁾ Concentric pre-cutouts of the PG and ISO/metric type (EN 50262).

⁽²⁾ Accessories also delivered:

■ mini enclosures: class II plugs

■ enclosures: class II plugs and blanking plates (5 modules of 18 mm per row).

Part numbers of the main accessories

Name	Description	Mini-enclosures	Enclosures	Part No.
Association kit	2 sleeves + 4 nuts	■	■	13934
Wall mounting lugs		■	■	13935
Slotted mounting plate		■	■	13941
Paint plate	12 modules	■	■	13944
	18 modules	■	■	13945
Wiring strap de filerie		■	■	13946
Sealing kit		■	■	13947
Keylock		■	■	13948
Insert	Triangle	■	■	13949
	Square	■	■	13950

Other accessories available for these enclosures ⁽¹⁾:

Row separator, jack-up block, junction for trunking, blanking plate, terminal block support, insulated terminal blocks, IP2 covers, cable support sleeves, cable gland, self-adhesive symbols, self-adhesive sheets.

Enclosures and mini enclosures for modular switchgear

Kaedra

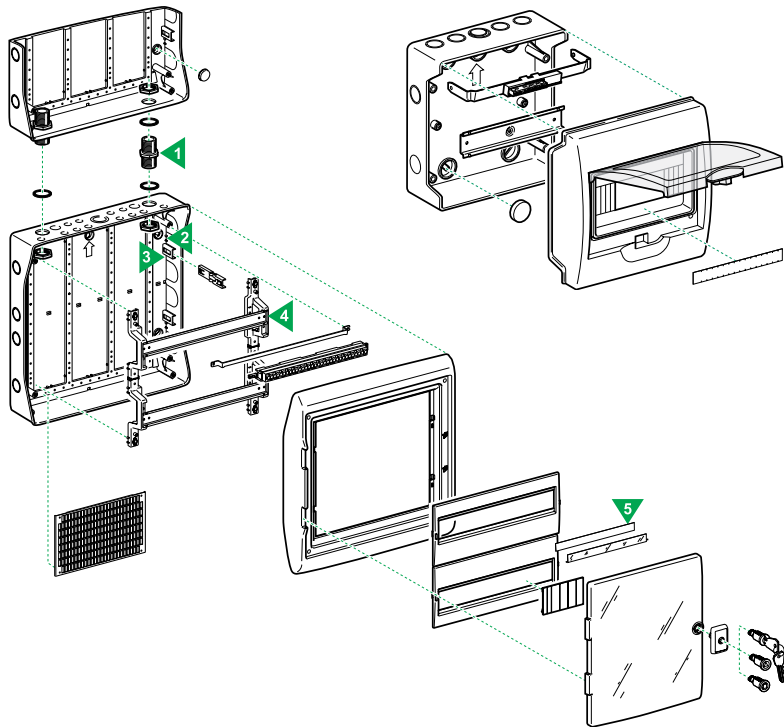

A few tricks

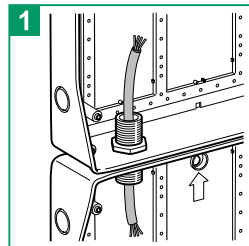

Add-on possibility

Enclosures can be horizontally or vertically associated keeping the IP65 and allowing cable insertion.

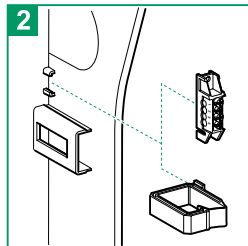

Dovetails

Arranged on the back and on the chassis, they can accommodate:

- 4-hole terminal blocks
- wiring straps.

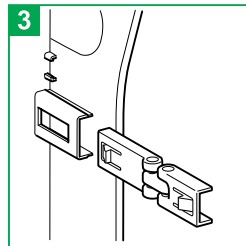

Back/front face hinges

Clipped onto the right or left, they simplify cabling and working on the interface zone.

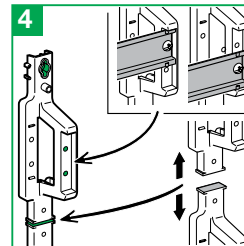

Chassis

- DIN symmetrical rails positionable in 2 depths and 2 heights to privilege cabling room
- Chassis that can be severed to install a mounting plate on the back

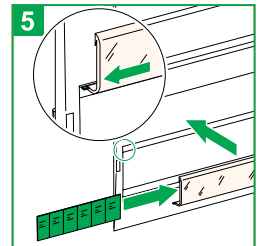

Marking

Clip-on label covers ensure neat, quick and upgradeable marking.

Mechanical data

Enclosure

- Reversible front face for opening of door to the left or right
- Inside depth available for installation of non-modular switchgear between the slotted mounting plate and the plain front plate: 100 mm
- Reversible front plate according to distance between axes of rails (125, 150, 175 mm)

Mini enclosure

- Clip-on terminal block support
- Back with dovetail to accommodate 4-hole terminal block and wiring strap.

Technical data

- Self-extinguishing insulating material
- Operating temperature: -25 °C to +60 °C
- Colour: light grey RAL 7035 and transparent green door
- IP65 as per IEC 60529
- IK09 as per EN 50102
- Class 2: total insulation
- Flame and abnormal heat resistance: 650 °C as per IEC 60695-2-1
- Complies with standard IEC 60439-3
- Resistance to chemicals and atmospherics agents: see PAGE 93140.



The opaque door universal enclosure provides a zone to install non-modular switchgear. The universal enclosure for power outlets provides a row for modular switchgear and a universal zone.

Opaque door universal enclosures

340 x 460	340 x 610	448 x 460	448 x 610	448 x 842
13195	13196	13197	13198	13199

Universal enclosures for power outlets

138 x 460	236 x 460	340 x 335	340 x 460	448 x 460
5 modules	8 modules	12+1 modules	12+1 modules	18+1 modules
13189	13190	13191	13192	13193

Mechanical data

Opaque door universal enclosure

Delivered with a slotted mounting plate mounted at the back

Available depth for installation of non-modular switchgear on mounting plate:
130 mm

Reversible front face to change door opening direction

Technical data

Self-extinguishing insulating material

Operating temperature: -25°C to +60°C

Colour: Light grey RAL 7035

IP65 As per IEC 60529

IK09 As per EN 50102

Class 2: Total insulation

Flame and abnormal heat resistance: 650°C as per IEC 60695-2-1

Complies with standard IEC 60439-3

Resistance to chemicals and atmospheric agents

Note: universal enclosures for power outlets can accommodate power outlets up to 125A.

Enclosures part numbers

Dimensions (mm)			No of modules	Pre-cutout (top and bottom) ⁽¹⁾					Part number		
W	H	D		M PG	16	20	25	32		50	
						11	16	21	29/36		
Opaque door universal enclosures											
340	460	160			6	6	2	3			13195
340	610	160			6	6	2	3			13196
448	460	160				10	4	2	1		13197
448	610	160				10	4	2	1		13198
448	842	160				10	4	2	1		13199
Universal enclosures for power outlets											
138	460	160	5			1	1	1			13189
236	460	160	8			2	2	3			13190
340	335	160	12+1		6	6	2	3			13191
340	460	160	12+1		6	6	2	3			13192
448	460	160	18+1			10	4	2	1		13193

1) Concentric pre-cutouts of the PG and ISO/metric type (EN 50262).

(2) Accessories also delivered:

- Opaque door universal enclosures: class II plugs, mounting plate
- Universal enclosures for power outlets: class II plugs, blanking plates (5 modules of 18 mm) and marking kit

Part numbers of the main accessories

Name	Part number
Association kit	13934
Wall mounting lug	13935
Jack-up block	13938
Junction for trunking	13939
Wiring strap	13946
Slotted mounting plate 150 x 250	13941

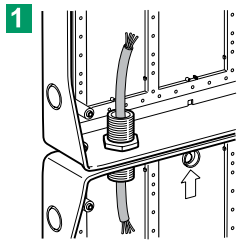
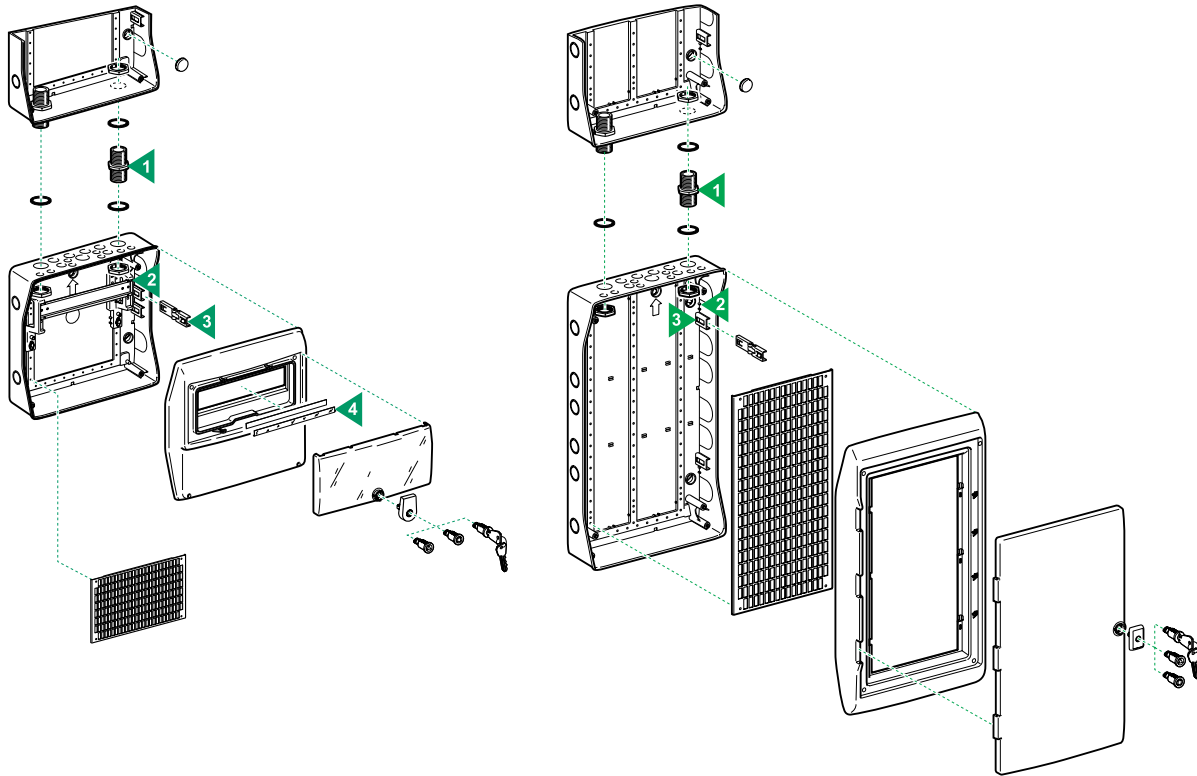

1 Add-on possibility
Enclosures can be horizontally or vertically associated keeping the IP65 and allowing cable insertion.

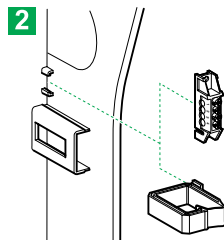

2 Dovetails
Arranged on the back and on the chassis, they can accommodate:
■ 4-hole terminal blocks
■ wiring straps

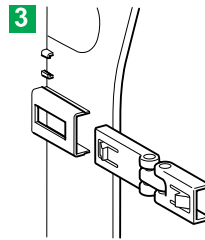

3 Back/front face hinges
Clipped onto the right or left, they simplify cabling and working.

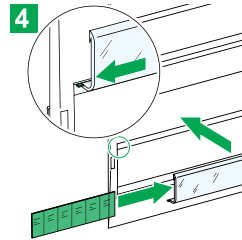

4 Marking
Clip-on label covers ensure neat, quick and upgradeable marking.



Enclosures that can be installed alone, but also as an extension of another enclosure.

Number of 50 x 100 mm openings

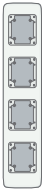
	3	4
		
	13993	13994

Mechanical data

This enclosure can also act as a cable duct

In enclosures with 3 or 4 openings, the kit for INS40/63/80 A must be mounted in the central openings

Technical data

Self-extinguishing insulating material

Operating temperature: -25°C to +60°C

Colour: Light grey RAL 7035

IP65 As per IEC 60529

IK09 As per EN 50102

Class 2: Total insulation

Flame and abnormal heat resistance: 650°C as per IEC 60695-2-1

Complies with standard IEC 60439-3

Resistance to chemicals and atmospheric agents

Part numbers of the main accessories

Name	Description	Part number
Association kit	2 sleeves + 4 nuts	13934
Wall mounting lugs		13935
Slotted mounting plate		13941
Plain front plate	12 modules	13944
Interface plate for	65 x 85 power outlets	13136
	65 x 65 or 75 x 75 power outlets	13137
	Pushbutton controls	13138
	Identification	13141
Interface kit	INS40/63/80 A	13139
	Modular switchgear up to 4 modules (e.g. residual current circuit breaker)	13140
Wiring strap		13946
Sealing kit		13947

Other accessories available for these enclosures:

Jack-up block, insulated terminal blocks, cable support sleeves, cable gland.

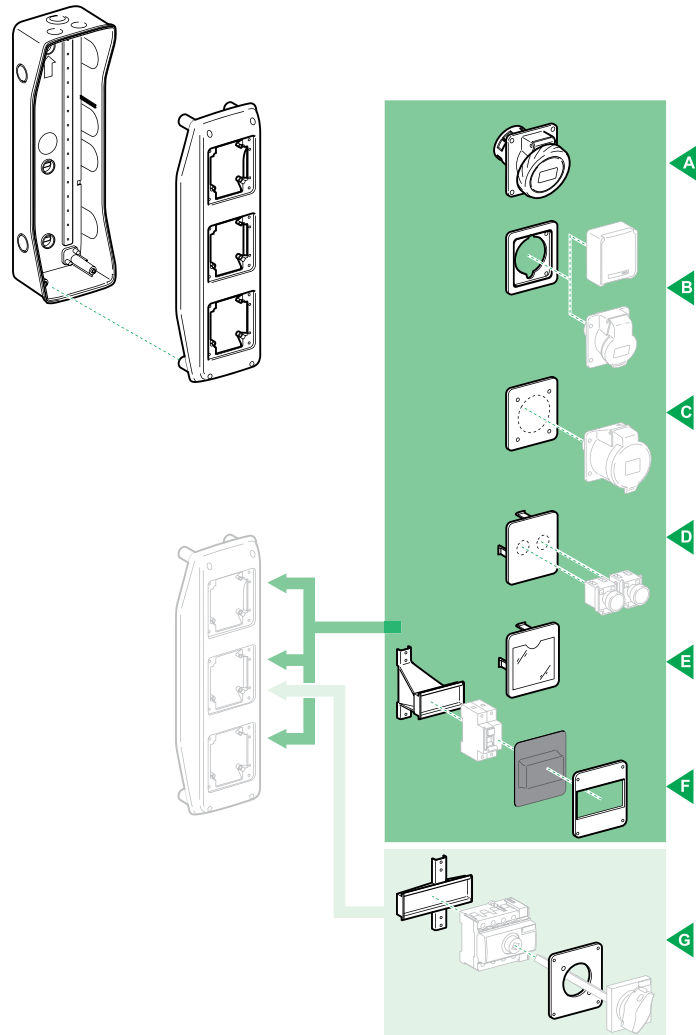

Everything for the interface

Direct mounting

With plate
Part no 13136

With plate
Part no 13137

With plate
Part no. 13138

With plate
Part no 13141

With kit
Part no 13140

With kit
Part no 13139

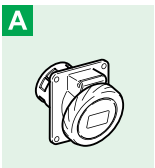

16/32 A slanting power outlets (90 x 100 mm).

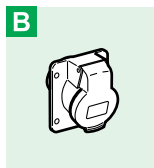

LV power outlets (65 x 85 mm).



LV and ELV power outlets (65 x 65 mm and 75 x 75 mm).

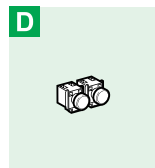

Buttons, indicator lights and switches 16 and 22 mm diameter.



Identification label.

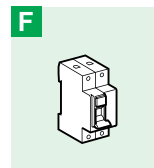

Modular switchgear up to 4 modules (e.g. residual current circuit breaker).



INS40/63/80 A.

Description

For enclosure installation

- Association kit: used for horizontal or vertical association of two enclosures with one another while preserving IP65
- Wall mounting lugs: used to fix the enclosure to the wall without using holes in the back of the enclosure
- Row separator: used to create IP2 insulated zones. For example: separate strong and weak current zones
- Jack-up block: used to detach the enclosure from the wall in order to route cables behind the enclosure (2 lengths of 1 metre to be cut)
- Plain front plate: used to hide a zone without modular switchgear
- Blanking plate: clipped onto the front plates to conceal slots with no devices
- Junction for trunking: allows tidy incoming of cables in a trunking

For switchgear installation

- Functional plates for 90 x 100 mm slot:
 - Adaptation (screwed on) for 65 x 85 mm power outlets
 - Blanking or adaptation (screwed on) for 65 x 65 mm or 75 x 75 mm power outlets (slot to be punched out)
 - Blanking or adaptation (clipped on) for buttons, indicator lights and switches of diameters 16 and 22 mm (1 central slot or 2 side by side to punch out).
 - Blanking for identification (clipped on)
- Functional plates for 103 x 225 mm slot:
 - Adaptation (screwed on) with 2 openings: 65 x 85 mm and 90 x 100 mm.
 - Blanking or adaptation (screwed on) offering 1 slot for 65 x 65 mm or 75 x 75 mm power outlets (to be punched out) and a universal zone
 - Adaptation (screwed in) for 63 A 100 x 107 mm LV power outlet
- Interface kit for 90 x 100 mm slot for:
 - INS40 to 80 A (chassis + plate)
 - Modular switchgear up to 4 modules e.g. residual current circuit breaker (chassis + plate + membrane)
- Slotted plate (150 x 250 mm): screwed onto the back of the enclosure, used to fix non-modular devices

For electrical connection

- Terminal block support: flat iron (12 x 2 mm), 2 versions: screwed onto the pins or onto the chassis
- Set of insulated terminal blocks with IP42 covers:
 - 4 holes: clipped onto the terminal block supports, fixed onto walls by dovetails,
 - 8 holes: clipped onto the terminal block supports, clipped onto DIN symmetrical rail, screwed onto the back
 - 32 holes: clipped onto the terminal block supports
- Wiring strap: used to guide cables along walls for simplified cabling (set of 5)
- Cable support sleeves: used for incoming flexible cables
- Cable glands: used for cable and tube incoming, guaranteeing tightness and mechanical withstand

For identification

- Self-adhesive symbol: allows identification of feeders by symbols:
 - Currents: loads (power outlet, lighting, convector, etc.), places (bedroom, bathroom, etc.)
 - Special: loads (surge arrester, gate, swimming pool, etc.), places (technical room, computer room, etc.)
- Self-adhesive sheets for SISmarker printing: allows printing of customised labels using the SISmarker software

For enclosure protection







- Sealing kit: used to seal the front face on the back (2 screws) and the front plates on the front face (4 kits)
- Keylock: Eurolocks combination no. 850. Installed in the door
- Insert (male square or triangle, female key supplied): installed in the door

For enclosure maintenance

- Front plate
- Chassis 1 row: can be combined to obtain a multi row chassis

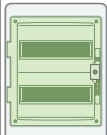
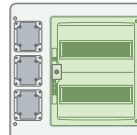
Terminal block composition

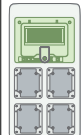
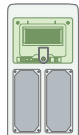
Number of holes Total	Cross section in mm ²		Width in mm
	10	16	
4	2	2	85
8	4	4	85
32	16	16	202

Name	Description	Use								Part no.
		mini enclosure	Enclosures							
										
For enclosure implementation										
Association kit	2 sleeves + 4 nuts + 4 joints									
Wall mounting lugs (set of 4)										
Row separator	12 modules wide									
	18 modules wide									
Jack-up block										
Junction for trunking	enclosure 340 mm wide									
	enclosure 448 mm wide									
Blanking plate (set of 10 x 5 modules)										
For switchgear implementation										
Plate for 85 x 65 slot for 50 x 50 power outlets										
Plate for 90 x 100 slot for 65 x 65 and 75 x 75 power outlets										
	ø 16 & 22mm pushbutton controls									
	blanking and identification									
Kit for 90 x 100 slot for INS40/63/80 A residual current circuit-breakers										
Plate for 103 x 225 slot for one 85 x 65 + one 90 x 100 slot blanking (blank to be slotted) (for 65x65 or 75x75mm power outlet)										
	63A LV power outlet (100x107 mm)									
Front plate	plain									
	12 modules									
	18 modules									
Slotted plate	150 x 250 mm									
For electrical connection										
Terminal blocks kit	5 x 4 holes (2 blue, 3 black) 2 black covers 2 green covers									
Terminal blocks kit	1 x 8 holes (blue) 1 green cover 1 support for 8 back mounting									
Terminal blocks kit	1 x 8 holes (blue) 1 green cover 1 support for 12 back mounting									
Terminal blocks kit	1 x 32 holes (blue) 1 green cover 1 support for 18 back mounting									
Terminal block support for mini enclosure	4 modules									
	6 modules									
	8 modules									
	12 modules									
Terminal block support for mounting on chassis	12 modules									
	18 modules									
Cable support sleeves varied diameter bag										
Cable gland	PG11									
	PG13,5									
	PG16									
	PG21									
	PG29									
	PG36									
Wiring strap (set of 5)										
For marking										
Self-adhesive symbols	standard									
	special									
Self-adhesive sheets for SISmarker printing										
For enclosure protection										
Sealing kit										
Keylock										
Insert	triangle									
	square									
For enclosure maintenance										
Front plate	12 modules									
	18 modules									
Chassis 1 row	12 modules									
	18 modules									

<i>Dissipated power, impedance and voltage drop</i>	<i>page 11/2</i>
<i>Tripping curves</i>	<i>page 11/4</i>
<i>Influence of ambient temperature</i>	<i>page 11/11</i>
<i>Short-circuit current limiting</i>	<i>page 11/18</i>
<i>Direct current applications</i>	<i>page 11/36</i>
<i>400 Hz network</i>	<i>page 11/50</i>
<i>Motor and transformer protection</i>	<i>page 11/52</i>
<i>Safepact 2</i>	<i>page 11/56</i>
<i>Powerpact 4</i>	<i>page 11/57</i>
<i>Degrees of protection provided by enclosures</i>	<i>page 11/58</i>
<i>Earth loop impedance values</i>	<i>page 11/59</i>

Acti9 products

The following table indicates the average dissipated power per pole in W for a current equal to the rating of the device and at the operating voltage.

Rating (A)	0.5	1	1.6	2	2.5	3	4	6	6.3	10	12.5	13	16	20	25	32	40	50	63	80	100	125
Circuit breakers																						
iC60	2.3	2.3		1.9		2.2	2.4	1.3		2		2	2.1	2.2	2.7	2.8	3.6	4	5.6			
iC60L-MA			0.7		0.2		0.6		0.9	1.1	1.5		1.6		0.8		2					
		2.3		1.9		2.2	2.4	2.7		1.8			2.5	3	3.1	3.5	3.6	4	5.6			
RCCB																						
iID 2P													0.8		0.9		2.6		2.6	3	5	
4P															0.7		1.9		1.5	2.6	4.3	
															2.7		3.6		5.6			
Add-on residual current devices																						
Vigi iC60 10 mA															3							
30 mA															1.4		1.1		2.3			
100 mA															1.1				2.3			
300 mA															1.3		0.9		2.3			
500 mA															1.1		0.9		2.3			
1000 mA																			2.3			
Contactors																						
iCT/iCT+ Power circuit													0.6	0.9	1.4		1.5		3.4		4	
Impulse relays																						
iTL/iTL+ Power circuit													0.6			1.5						
Push-buttons																						
iPB														0.6								
Selector switches																						
iSSW														0.8								
iCMA/iCMB/iCMC/ iCMD/iCMV									0.4													
Switch-disconnectors																						
iSW														0.8		1.3	1.1		1.8		3.4	4.2
iSW-NA 2P																	0.7		1.8		3	5
4P																	0.6		1.5		2.5	4.1
Indicator lights																						
iIL	0.3																					

Note: When the enclosure's thermal balance, consider the 4P devices load is only on 3 phases

Impedance calculation:

$$Z = P / I^2$$

Z: impedance in Ohms

P: dissipated power in Watts (table values)

I: rating in Amperes

Voltage drop calculation:

$$U = P / I$$

U: voltage drop in Volts

P: dissipated power in Watts (table values)

I: rating in Amperes

Multi 9 products

The following table indicates the average dissipated power per pole in W for a current equal to the rating of the device and at the operating voltage.

Rating (A)	0.5	1	1.6	2	2.5	3	4	6	6.3	10	12.5	13	16	20	25	32	40	50	63	80	100	125
Circuit breakers																						
IDPN		2.5		1.9		2.1	2.6	2.7		2.7		3.3	3.2	4.7	4.7	4.6	5.8					
C60/C60H-DC	2.2	2.3		2.6		2.2	2.4	2.7		1.8		2.5	2.5	3	3.1	3.5	4.3	4.8	6.1			
C120										1.3			2.1	2.3	2.5	3.2	3.1	3.2	3	3.2	2	4.1
NG125										1.7			2.4	2.7	2.7	3.8	3.8	4.2	3.8	4.8	4.3	7.9
C60L-MA			2.4		2.5		2.4		3	2	2.5		2.6		3		4.6					
NG125L-MA							3		2	2	3.1		2.5		3.2		4		5.5	6		
RCCB																						
ID Type A/AC															1.4		3.6		4.4	7.2	18	28
ID Type B															1.2		2.9		7.2	12	18	28
Contactors																						
CT/CT+ Power circuit													0.9				1.4					
Impulse relays																						
TL/TL+ Power circuit													0.9			1.4						
Push-buttons																						
PB														0.6								
Selector switches																						
CM														0.8								
CMA/CMB/CMC/CMD/CMV									0.4													
Switch-disconnectors																						
I														0.8		1.3	1.1		1.8		3.4	4.2
I-NA																	3.2		3.2			
NG125NA																			5.5	6	7	9
Indicator lights																						
V		0.3																				

Note: When the enclosure's thermal balance, consider the 4P devices load is only on 3 phases

Impedance calculation:

$$Z = P / I^2$$

Z: impedance in Ohms

P: dissipated power in Watts (table values)

I: rating in Amperes

Voltage drop calculation:

$$U = P / I$$

U: voltage drop in Volts

P: dissipated power in Watts (table values)

I: rating in Amperes

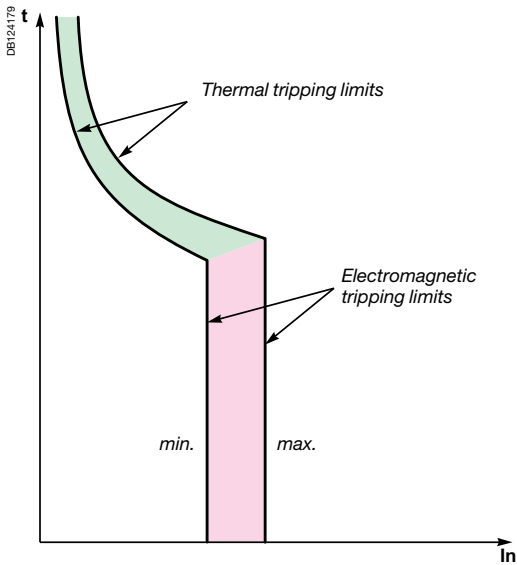

The following curves show the total fault current breaking time, depending on its amperage. For example: based on the curve on page 11/5, an iC60 circuit breaker of curve C, 20 A rating, will interrupt a current of 100 A (5 times the rated current In) in:

- 0.45 seconds at least
- 6 seconds at most.

The circuit breakers' tripping curves consist of two parts:

- tripping of overload protection (thermal tripping device): the higher the current, the shorter the tripping time
 - tripping of short-circuit protection (magnetic tripping device): if the current exceeds the threshold of this protection device, the breaking time is less than 10 milliseconds.
- For short-circuit currents exceeding 20 times the rated current, the time-current curves do not give a sufficiently precise representation. The breaking of high short-circuit currents is characterized by the current limiting curves, in peak current and in energy. The total breaking time can be estimated at 5 times the value of the ratio $(I^2t)/(I)^2$.

Verification of the discrimination between two circuit breakers

By superimposing the curve of a circuit breaker on that of the circuit breaker installed upstream, one can check whether this combination will be discriminating in cases of overload (discrimination for all current values, up to the magnetic threshold of the upstream circuit breaker). This verification is useful when one of the two circuit breakers has adjustable thresholds; for fixed-threshold devices, this information is provided directly by the discrimination tables.

To check discrimination on short circuit, the energy characteristics of the two devices must be compared.

Alternative current 50/60 Hz

iC60

According to IEC/EN 60898-1 (reference temperature 30°C)

Curves B, C, D rating up to 4 A

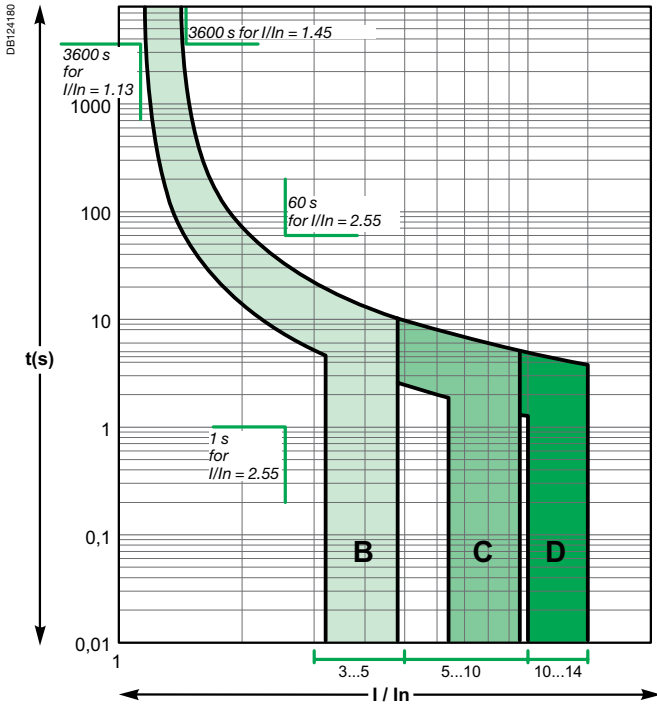

Curves B, C, D rating 6 A to 63 A

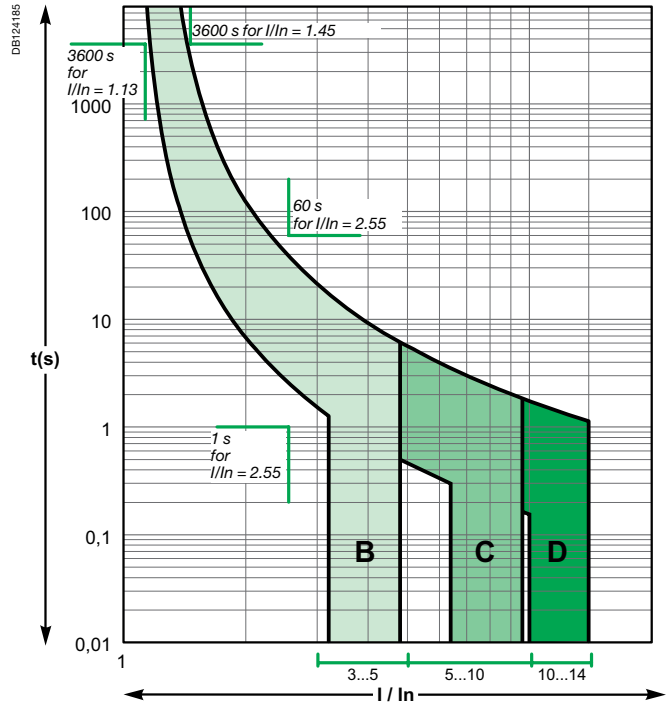

C120N/H

According to IEC/EN 60898-1 (reference temperature 30°C)

Curves B, C, D

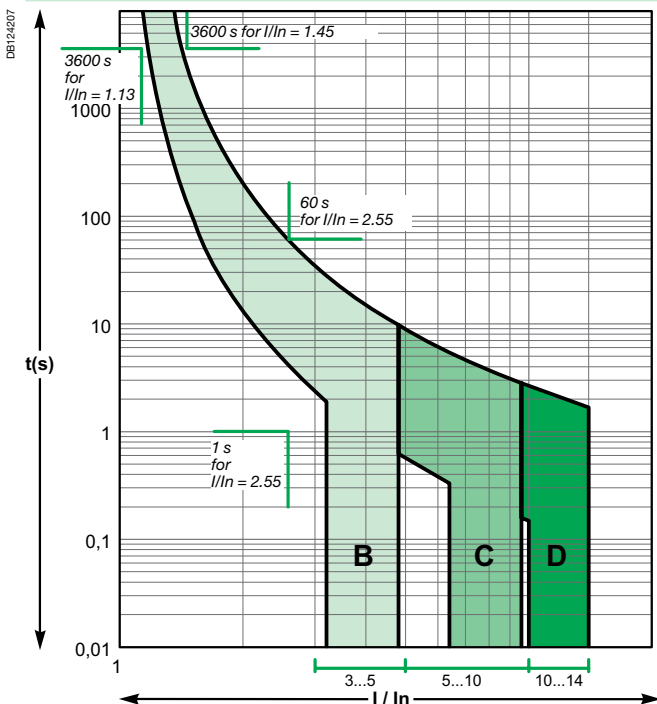

iDPN, DPN N (circuit-breaker and residual current device)

According to IEC/EN 60898-1 (reference temperature 30°C)

Curves B, C, D

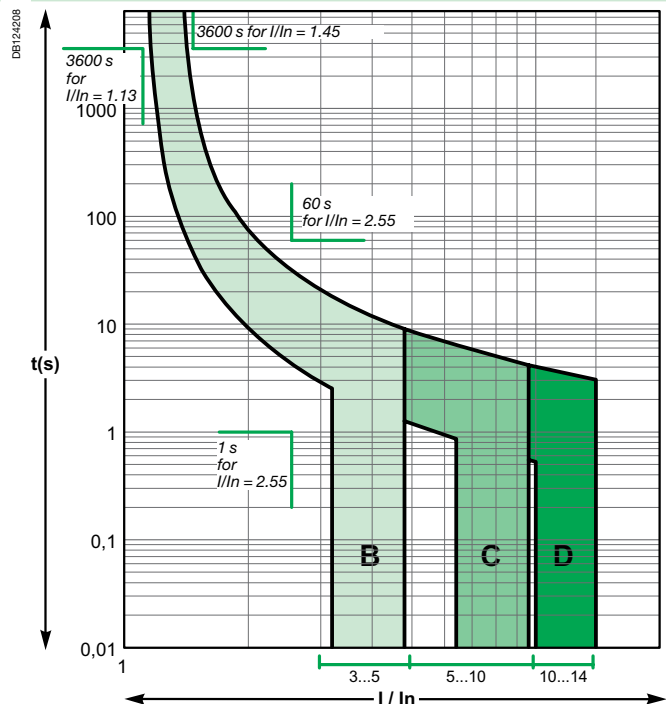

Alternative current 50/60 Hz

C60

According to IEC/EN 60898-1 (reference temperature 30°C)

Curves B, C, D

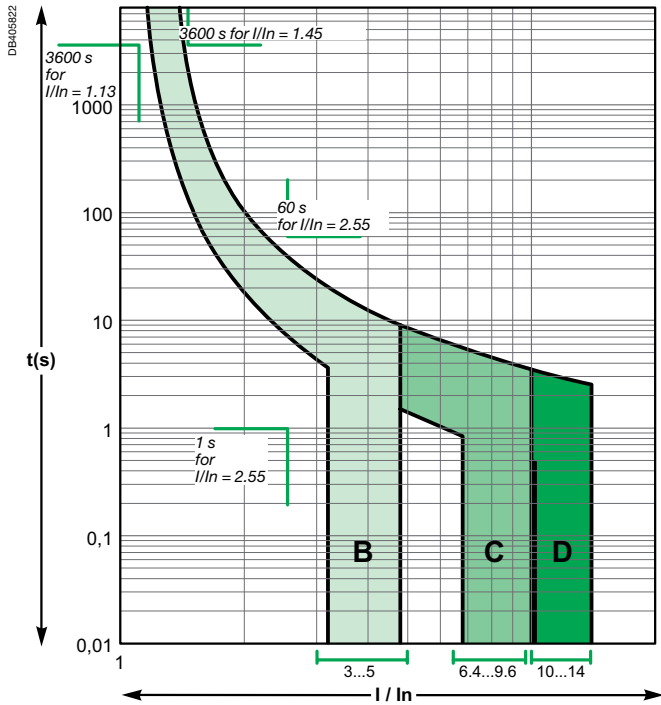

Alternative current 50/60 Hz

iC60

According to IEC/EN 60947-2 (reference temperature 50°C)

Curves B, C, D rating up to 4 A

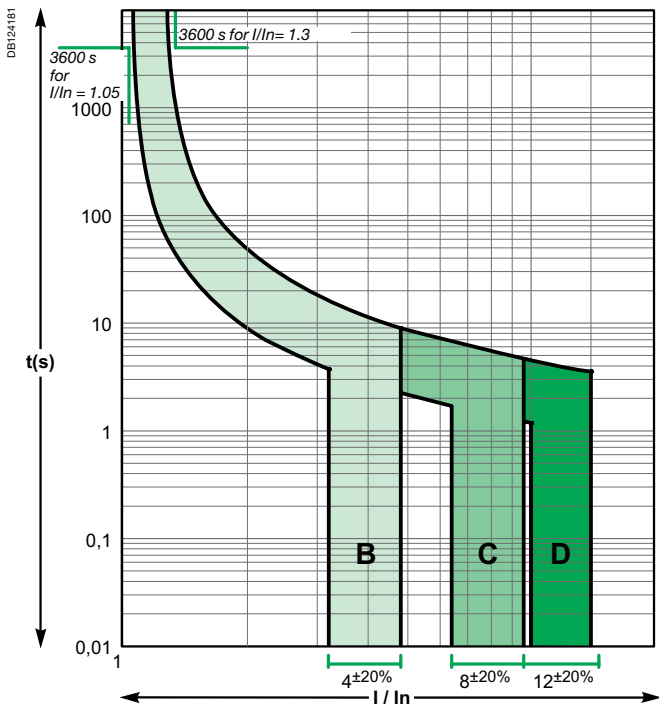

Curves Z, K rating up to 4 A

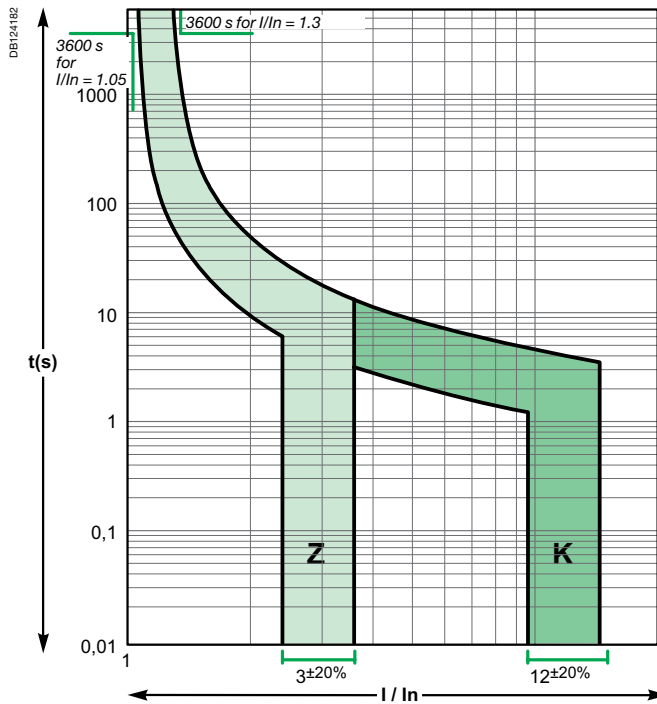

Curves B, C, D rating 6 A to 63 A

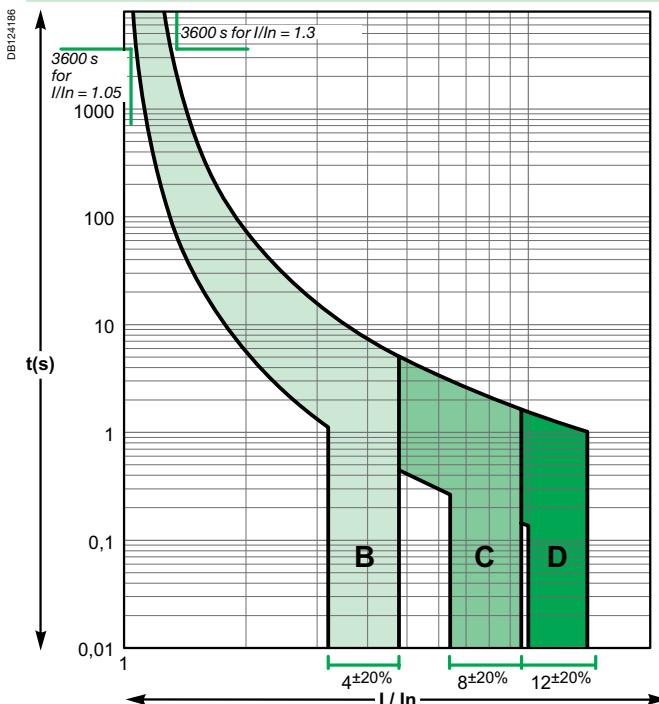

Curves Z, K rating 6 A to 63 A

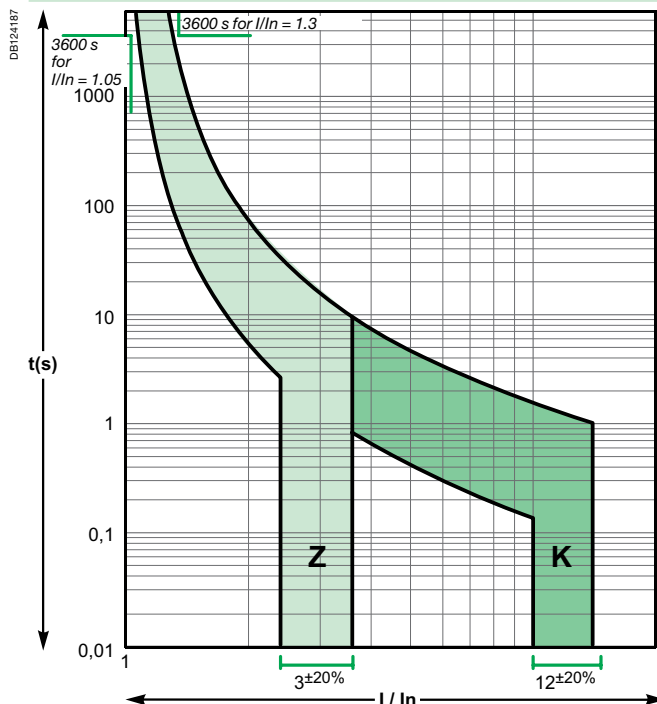

Alternative current 50/60 Hz

Reflex iC60N/H

According to IEC/EN 60947-2 (reference temperature 50°C)

Curves B, C, D

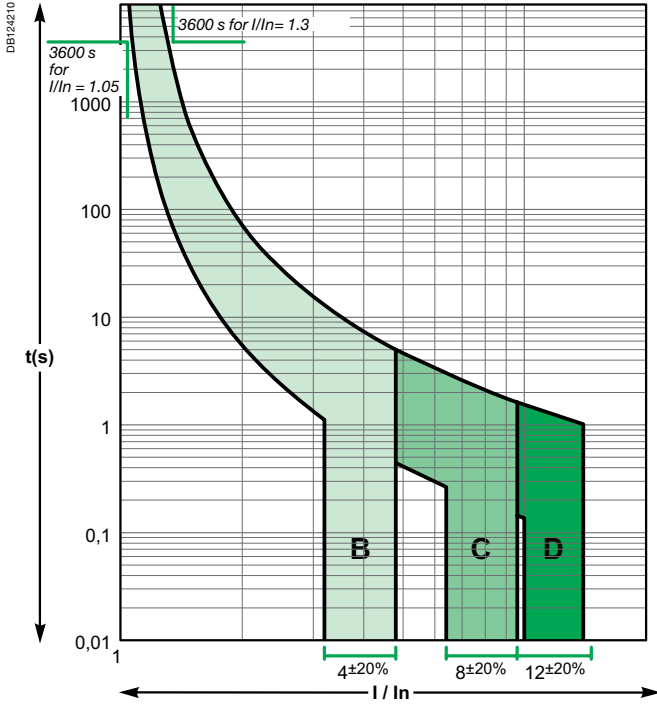

NG125a/N/H/L

According to IEC/EN 60947-2 (reference temperature 40°C)

Curves B, C, D

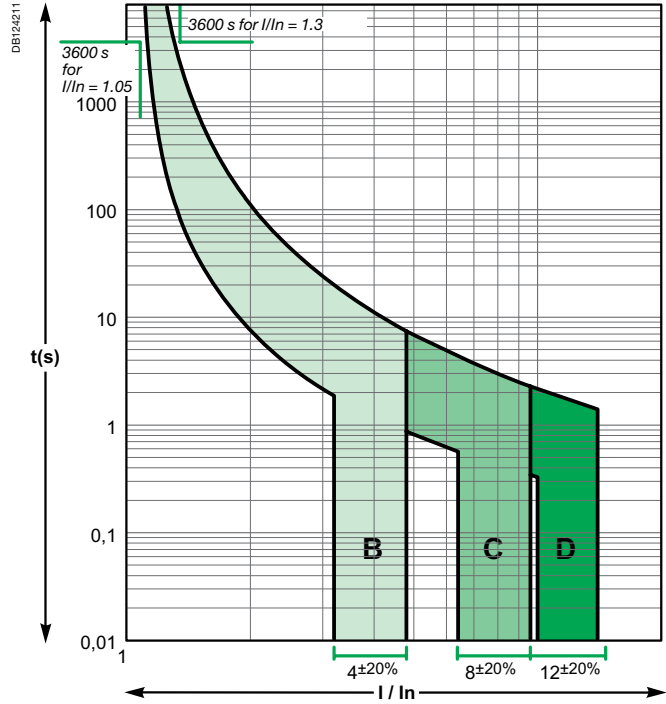

C60

According to IEC/EN 60947-2 (reference temperature 50°C)

Curves B, C, D

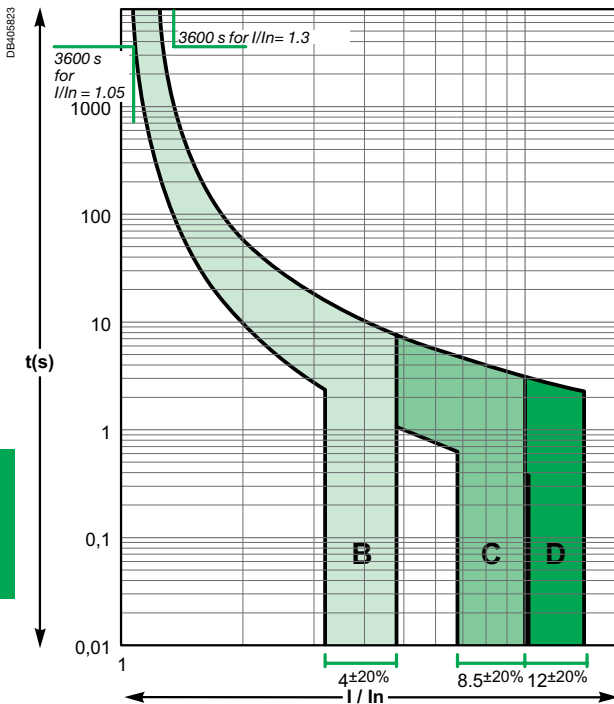

Direct current

iC60N/H/L

According to IEC/EN 60947-2 (reference temperature 50°C)

Curves B, C, D rating up to 4 A

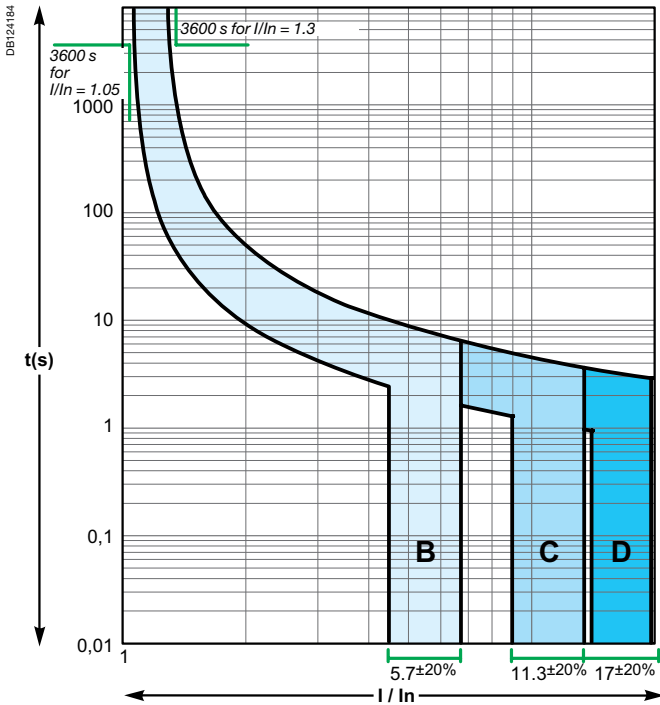

Curves Z, K rating up to 4 A

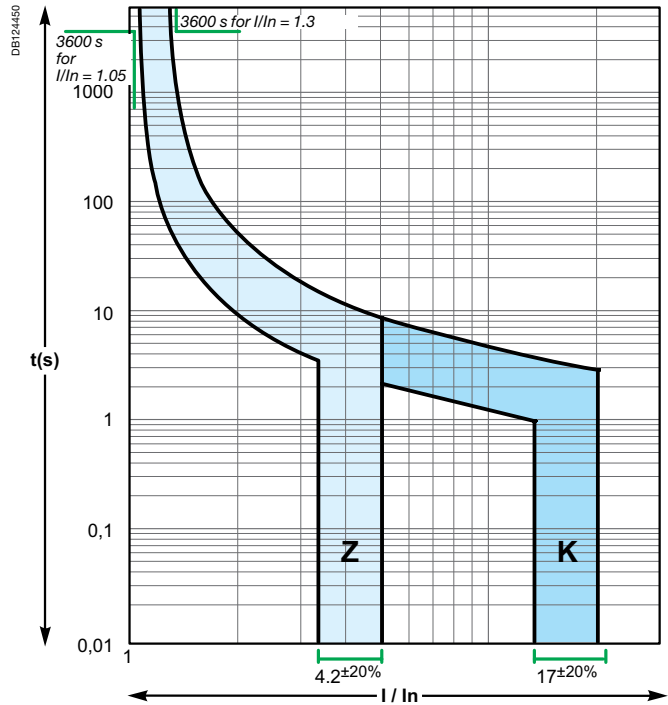

Curves B, C, D rating 6 A to 63 A

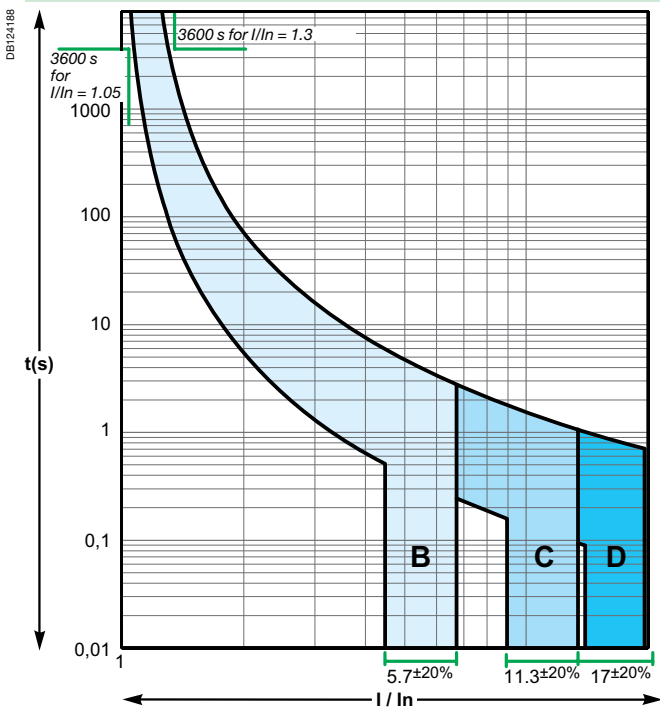

Curves Z, K rating 6 A to 63 A

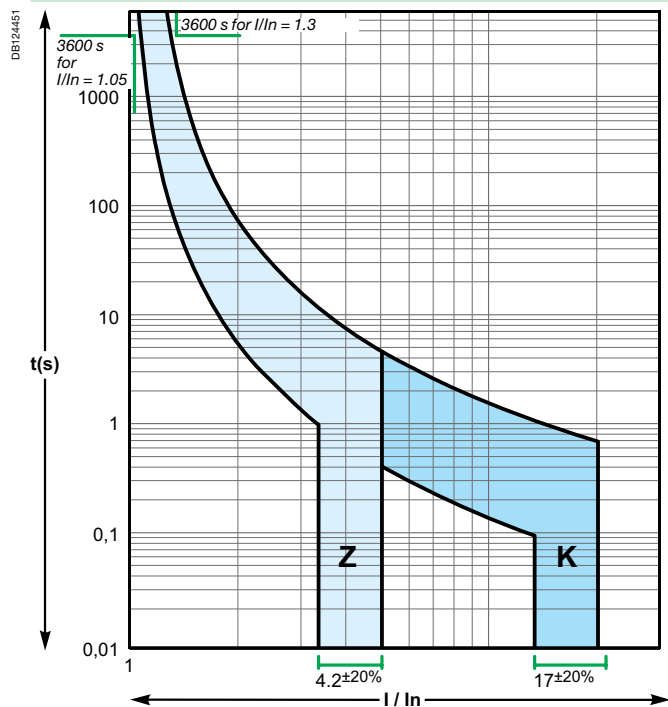

Direct current

C60H-DC

According to IEC/EN 60947-2 (reference temperature 25°C)

Curve C

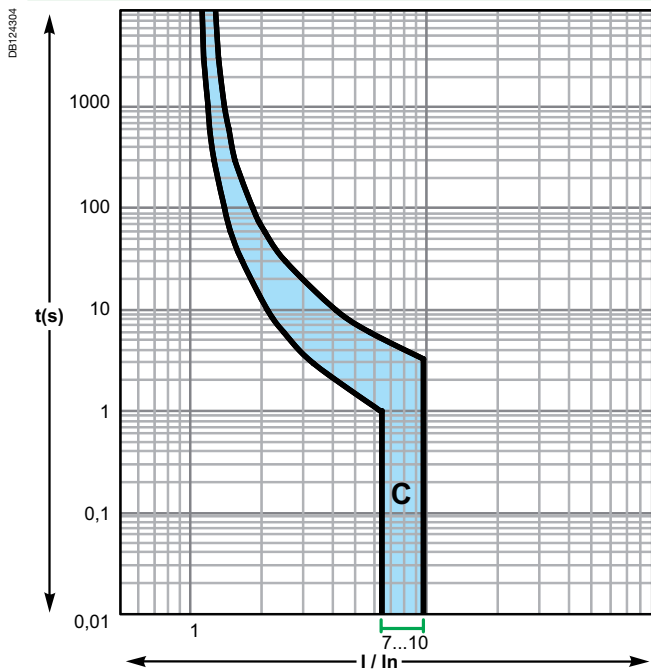

C60

According to IEC/EN 60947-2 (reference temperature 50°C)

Curves B, C, D

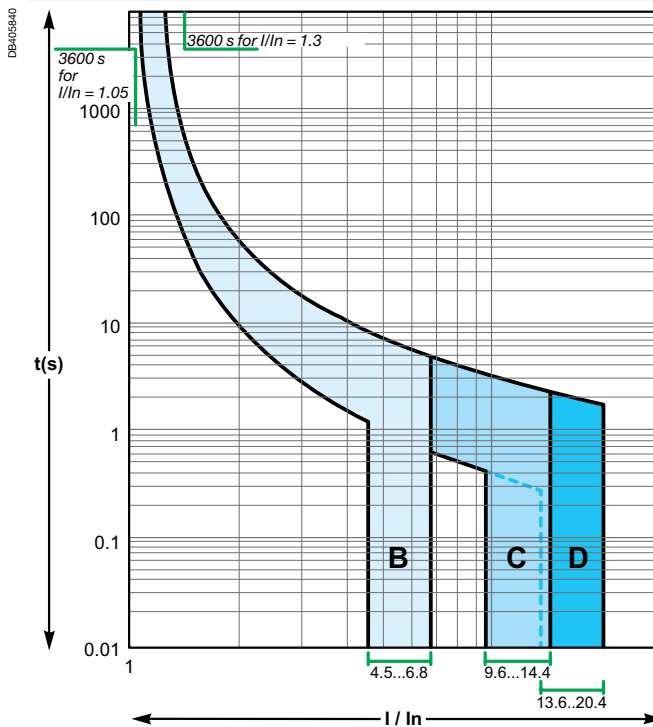

NG125a/N/H/L

According to IEC/EN 60947-2 (reference temperature 40°C)

Curves B, C, D

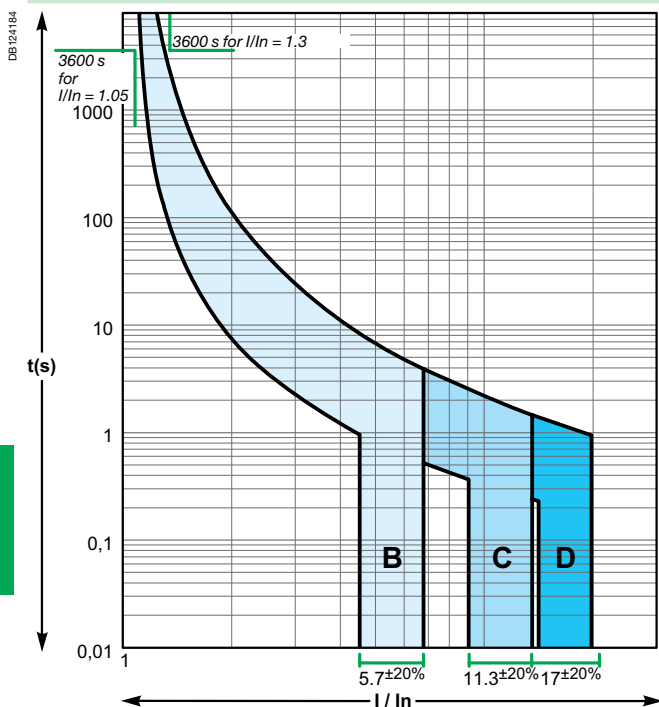

Influence of temperature on the operation

Devices	Characteristics influenced by temperature	Temperature	
		Min.	Max.
iDPN, C60H-DC, C60, C120, NG125, C60PV-DC circuit breakers	Tripping on overload	-30°C	+70°C
iC60N circuit breakers	Tripping on overload	-25°C	+60°C
Circuit breakers	With Vigi (AC)	-5°C	+60°C
	With Vigi (A, SI)	-25°C	+60°C
Reflex iC60	Tripping on overload	-25°C	+60°C
iC60H RCBO,	Tripping on overload	-15°C	+60°C
C60NA-DC, SW60PV-DC switch-disconnectors	Maximum operating current	-25°C	+70°C
	Maximum operating current	-5°C	+60°C
iID residual current circuit breakers	AC	-5°C	+60°C
	A, SI	-25°C	+60°C
Switches	iSW	-20°C	+50°C
	iSW-NA	-35°C	+70°C
Protection auxiliaries	None	-35°C	+70°C
RCA, ARA control auxiliaries	None	-25°C	+60°C
iCT contactors	Installation conditions	-5°C	+60°C
iTL impulse relays	None	-20°C	+50°C
iCT, iTL auxiliaries	None	-20°C	+50°C
Distribloc	Maximum operating current	-25°C	+60°C
Multiclip	Maximum operating current	-25°C	+60°C

Note: the temperature considered is the temperature viewed through the device.

Circuit breakers

High temperatures

- A rise in temperature causes lowering of the thermal threshold (tripping on overload).
 - Protection is still ensured: the tripping threshold remains lower than the current acceptable by the cable (I_2)
 - To prevent nuisance tripping, it should be checked that this threshold remains higher than the maximum operating current (I_B) of the circuit, defined by:
 - the rated load currents,
 - the coefficients of expansion and simultaneity of use.
- If the temperature is sufficiently high for the tripping threshold to become lower than the operating current I_B , switchboard ventilation should be provided for.

Low temperatures

- A fall in temperature increases the thermal tripping threshold of the circuit breaker.
- There is no risk of nuisance tripping: the threshold remains higher than the maximum operating current of the circuit (I_B) demanded by the loads.
- It should be checked that the cable remains suitably protected, i.e. that its acceptable current (I_2) is higher than the values shown in the following tables (in amperes).

When the ambient temperature could vary within a broad range, both these aspects must be taken into account:

- the difference between the maximum operating current of the circuit (I_B) and the tripping threshold of the circuit breaker for the minimum ambient temperature,
- the difference between the strength of the cable (I_2) and the maximum tripping threshold of the circuit breaker for the maximum ambient temperature.

Maximum permissible current

- The maximum current allowed to flow through the device depends on the ambient temperature in which it is placed.
- The ambient temperature is the temperature inside the enclosure or switchboard in which the devices are installed.
- The reference temperature is in a halftone colour for the different devices.

- When several devices operating simultaneously are mounted side by side in a small enclosure, a temperature rise in the enclosure results in a reduction in the operating current. A reduction coefficient of 0.8 will then have to be assigned to the rating (already derated, if applicable, depending on the ambient temperature).

■ Example:
 Depending on the ambient temperature and the method of installation, the table below shows how to determine, for an iC60, the operating currents not to be exceeded for ratings 25 A, 32 A and 40 A (reference temperature 50°C).

Operating current not to be exceeded (A)							
Installation conditions (IEC 60947-2)		iC60 alone			Several iC60 in the same enclosure (calculate with the reduction coefficient indicated below)		
Ambient temperature (°C)		35°C	50°C	65°C	35°C	50°C	65°C
Type	Nominal rating (A)	Actual rating (A)					
iC60	25	26.35	25	23.57	26.35 x 0.8 = 21	25 x 0.8 = 20	23.57 x 0.8 = 19
	32	34	32	29.9	34 x 0.8 = 27	32 x 0.8 = 25.6	29.9 x 0.8 = 24
	40	42.5	40	37.34	42.5 x 0.8 = 34	40 x 0.8 = 32	37.34 x 0.8 = 30

IEC 60898-1

C120 derating table (IEC 60898-1)

C120	Ambient temperature (°C)																				
Rating	-30	-25	-20	-15	-10	-5	0	+5	+10	+15	+20	+25	+30	+35	+40	+45	+50	+55	+60	+65	+70
10 A	12.9	12.7	12.5	12.2	12	11.8	11.5	11.3	11	10.8	10.5	10.3	10	9.7	9.4	9.1	8.8	8.5	8.2	7.9	7.5
16 A	19.4	19.1	18.8	18.6	18.3	18	17.8	17.5	17.2	16.9	16.6	16.3	16	15.7	15.4	15.1	14.7	14.4	14	13.7	13.3
20 A	24.6	24.2	23.9	23.5	23.2	22.8	22.4	22	21.6	21.2	20.8	20.4	20	19.6	19.1	18.7	18.2	17.7	17.3	16.8	16.2
25 A	30.9	30.5	30	29.5	29.1	28.6	28.1	27.6	27.1	26.6	26.1	25.5	25	24.4	23.9	23.3	22.7	22.1	21.5	20.8	20.1
32 A	38.9	38.4	37.9	37.3	36.8	36.2	35.6	35	34.5	33.9	33.3	32.6	32	31.4	30.7	30	29.3	28.6	27.9	27.2	26.4
40 A	49.8	49.1	48.3	47.6	46.8	46	45.2	44.4	43.5	42.7	41.8	40.9	40	39.1	38.1	37.1	36.1	35.1	34.1	33	31.8
50 A	62.2	61.3	60.4	59.4	58.4	57.5	56.5	55.4	54.4	53.3	52.2	51.1	50	48.8	47.7	46.4	45.2	43.9	42.6	41.2	39.8
63 A	78.6	77.5	76.3	75	73.8	72.5	71.3	69.9	68.6	67.3	65.9	64.5	63	61.5	60	58.4	56.8	55.2	53.5	51.7	49.9
80 A	98.4	97	95.6	94.2	92.7	91.2	89.7	88.1	86.6	85	83.4	81.7	80	78.3	76.5	74.7	72.8	70.9	69	67	64.9
100 A	124.5	122.6	120.7	118.8	116.9	114.9	112.9	110.9	108.8	106.6	104.5	102.3	100	97.7	95.3	92.9	90.4	87.8	85.2	82.5	79.6
125 A	157	154.6	152.2	149.7	147.1	144.6	141.9	139.2	136.5	133.7	130.9	128	125	122	118.8	115.6	112.3	108.9	105.4	101.8	98

Tertiary/Industry (IEC 60947-2)

iDPN derating table (IEC 60947-2)

iDPN		Ambient temperature (°C)																				
Rating	Curve	-30	-25	-20	-15	-10	-5	0	+5	+10	+15	+20	+25	+30	+35	+40	+45	+50	+55	+60	+65	+70
1 A	B, C, D	1.69	1.66	1.62	1.59	1.55	1.51	1.47	1.43	1.39	1.35	1.3	1.26	1.21	1.16	1.11	1.06	1	0.94	0.88	0.81	0.73
2 A	B, C, D	2.68	2.64	2.6	2.56	2.52	2.48	2.44	2.4	2.36	2.32	2.28	2.23	2.19	2.14	2.1	2.05	2	1.95	1.9	1.85	1.79
3 A	B, C, D	4.03	3.97	3.91	3.86	3.8	3.74	3.68	3.61	3.55	3.49	3.42	3.36	3.29	3.22	3.15	3.07	3	2.92	2.85	2.77	2.68
4 A	B, C, D	5.26	5.19	5.12	5.05	4.98	4.9	4.83	4.75	4.67	4.6	4.52	4.43	4.35	4.27	4.18	4.09	4	3.91	3.81	3.72	3.62
6 A	B, C, D	7.51	7.42	7.34	7.25	7.16	7.07	6.98	6.89	6.8	6.7	6.61	6.51	6.41	6.31	6.21	6.11	6	5.89	5.78	5.67	5.56
10 A	B	12.5	12.3	12.2	12.1	11.9	11.8	11.6	11.5	11.3	11.2	11	10.8	10.7	10.5	10.3	10.2	10	9.8	9.7	9.5	9.3
10 A	C, D	13	12.9	12.7	12.5	12.3	12.2	12	11.8	11.6	11.4	11.2	11	10.8	10.6	10.4	10.2	10	9.8	9.6	9.3	9.1
13 A	B	17	16.7	16.5	16.3	16.1	15.8	15.6	15.4	15.1	14.9	14.6	14.4	14.1	13.8	13.6	13.3	13	12.7	12.4	12.1	11.8
13 A	C, D	17.2	16.9	16.7	16.5	16.2	16	15.7	15.5	15.2	15	14.7	14.4	14.2	13.9	13.6	13.3	13	12.7	12.4	12.1	11.7
16 A	B, C	20.6	20.4	20.1	19.8	19.6	19.3	19	18.7	18.5	18.2	17.9	17.6	17.3	17	16.7	16.3	16	15.7	15.3	15	14.6
16 A	D	20.8	20.5	20.2	20	19.7	19.4	19.1	18.8	18.5	18.2	17.9	17.6	17.3	17	16.7	16.3	16	15.7	15.3	14.9	14.6
20 A	B	25.7	25.3	25	24.7	24.4	24	23.7	23.4	23	22.7	22.3	21.9	21.6	21.2	20.8	20.4	20	19.6	19.2	18.8	18.3
20 A	C, D	26	25.7	25.3	25	24.6	24.3	23.9	23.6	23.2	22.8	22.4	22	21.7	21.3	20.8	20.4	20	19.6	19.1	18.7	18.2
25 A	B, C, D	32	31.6	31.2	30.8	30.4	30	29.6	29.2	28.7	28.3	27.8	27.4	26.9	26.5	26	25.5	25	24.5	24	23.5	22.9
32 A	B, C, D	41.6	41.1	40.5	40	39.4	38.9	38.3	37.7	37.1	36.5	35.9	35.3	34.7	34	33.4	32.7	32	31.3	30.6	29.9	29.1
40 A	B, C, D	52.7	52	51.3	50.6	49.8	49.1	48.3	47.6	46.8	46	45.2	44.4	43.5	42.7	41.8	40.9	40	39.1	38.1	37.1	36.1

iC60, Reflex iC60 derating table (IEC 60947-2)

iC60		Ambient temperature (°C)																					
Rating		-35	-30	-25	-20	-15	-10	-5	0	+5	+10	+15	+20	+25	+30	+35	+40	+45	+50	+55	+60	+65	+70
0.5 A		0.66	0.65	0.64	0.63	0.63	0.62	0.61	0.6	0.59	0.58	0.57	0.56	0.55	0.54	0.53	0.52	0.51	0.5	0.49	0.48	0.47	0.45
1 A		1.32	1.3	1.28	1.27	1.25	1.23	1.21	1.2	1.18	1.16	1.14	1.12	1.1	1.08	1.06	1.04	1.02	1	0.98	0.96	0.93	0.91
2 A		2.79	2.75	2.71	2.67	2.63	2.58	2.54	2.5	2.45	2.4	2.36	2.31	2.26	2.21	2.16	2.11	2.05	2	1.94	1.89	1.83	1.76
3 A		4.21	4.15	4.08	4.02	3.96	3.89	3.83	3.76	3.69	3.62	3.55	3.48	3.4	3.32	3.25	3.17	3.08	3	2.91	2.82	2.73	2.64
4 A		5.62	5.54	5.46	5.37	5.29	5.2	5.11	5.02	4.93	4.83	4.74	4.64	4.54	4.44	4.33	4.22	4.11	4	3.88	3.76	3.64	3.51
6 A		8.55	8.42	8.29	8.16	8.03	7.89	7.75	7.61	7.46	7.31	7.16	7.01	6.85	6.69	6.52	6.35	6.18	6	5.81	5.62	5.43	5.22
10 A		13.3	13.2	13	12.8	12.6	12.5	12.3	12.1	11.9	11.7	11.5	11.3	11.1	10.9	10.7	10.5	10.2	10	9.8	9.5	9.3	9
13 A		17.1	16.9	16.7	16.4	16.2	16	15.8	15.5	15.3	15.1	14.8	14.6	14.3	14.1	13.8	13.6	13.3	13	12.7	12.4	12.1	11.8
16 A		21.1	20.8	20.6	20.3	20	19.7	19.5	19.2	18.9	18.6	18.3	18	17.7	17.3	17	16.7	16.3	16	15.7	15.3	14.9	14.5
20 A		26	25.7	25.4	25	24.7	24.4	24.1	23.7	23.4	23	22.7	22.3	21.9	21.6	21.2	20.8	20.4	20	19.6	19.2	18.7	18.3
25 A		31.9	31.6	31.2	30.8	30.4	30.1	29.7	29.3	28.9	28.5	28.1	27.6	27.2	26.8	26.4	25.9	25.5	25	24.5	24.1	23.6	23.1
32 A		42	41.5	41	40.5	39.9	39.4	38.8	38.2	37.7	37.1	36.5	35.9	35.3	34.6	34	33.3	32.7	32	31.3	30.6	29.9	29.1
40 A		52.6	51.9	51.3	50.6	49.9	49.2	48.5	47.8	47.1	46.4	45.6	44.9	44.1	43.3	42.5	41.7	40.9	40	39.1	38.2	37.3	36.4
50 A		67.1	66.3	65.4	64.5	63.5	62.6	61.6	60.7	59.7	58.7	57.7	56.7	55.6	54.5	53.4	52.3	51.2	50	48.8	47.6	46.3	45
63 A		86.3	85.1	83.9	82.7	81.4	80.1	78.9	77.6	76.2	74.9	73.5	72.1	70.7	69.2	67.7	66.2	64.6	63	61.4	59.7	57.9	56.1

Reflex iC60

C60 derating table (IEC 60947-2)

C60		Ambient temperature (°C)																				
Rating		-30	-25	-20	-15	-10	-5	0	+5	+10	+15	+20	+25	+30	+35	+40	+45	+50	+55	+60	+65	+70
0.5 A		0.68	0.67	0.66	0.65	0.64	0.63	0.62	0.61	0.6	0.59	0.58	0.56	0.55	0.54	0.53	0.51	0.5	0.49	0.47	0.46	0.44
0.75 A		0.93	0.92	0.91	0.9	0.89	0.88	0.87	0.86	0.85	0.83	0.82	0.81	0.8	0.79	0.78	0.76	0.75	0.74	0.72	0.7	0.68
1 A		1.31	1.3	1.28	1.27	1.25	1.23	1.21	1.19	1.17	1.15	1.13	1.11	1.09	1.07	1.05	1.02	1	0.98	0.95	0.93	0.91
2 A		2.55	2.59	2.56	2.52	2.49	2.45	2.41	2.37	2.34	2.3	2.26	2.22	2.17	2.13	2.09	2.04	2	1.95	1.91	1.88	1.84
3 A		3.81	4.04	3.98	3.92	3.85	3.79	3.73	3.66	3.59	3.52	3.45	3.38	3.31	3.23	3.16	3.08	3	2.92	2.83	2.82	2.76
4 A		4.9	4.86	4.81	4.76	4.7	4.65	4.59	4.54	4.48	4.42	4.37	4.31	4.25	4.19	4.13	4.06	4	3.94	3.87	3.81	3.74
6 A		7.93	7.82	7.71	7.6	7.49	7.38	7.27	7.15	7.03	6.91	6.79	6.66	6.54	6.41	6.27	6.14	6	5.86	5.71	5.56	5.42
8 A		10.37	10.23	10.09	9.96	9.82	9.68	9.54	9.4	9.25	9.11	8.96	8.81	8.65	8.49	8.33	8.17	8	7.83	7.65	7.47	7.31
10 A		13.3	13.2	13	12.8	12.6	12.4	12.2	12	11.8	11.6	11.4	11.2	10.9	10.7	10.5	10.2	10	9.8	9.5	9.2	9
13 A		17	16.9	16.6	16.4	16.2	15.9	15.7	15.4	15.2	14.9	14.7	14.4	14.1	13.9	13.6	13.3	13	12.7	12.4	12.1	11.8
16 A		20	19.8	19.5	19.3	19.1	18.8	18.6	18.4	18.1	17.9	17.6	17.3	17.1	16.8	16.6	16.3	16	15.7	15.4	15.1	14.8
20 A		26.9	26.6	26.2	25.8	25.4	25	24.6	24.2	23.7	23.3	22.9	22.4	22	21.5	21	20.5	20	19.5	18.9	18.4	17.9
25 A		32.9	32.5	32.1	31.6	31.1	30.7	30.2	29.7	29.2	28.7	28.2	27.7	27.2	26.7	26.1	25.6	25	24.4	23.8	23.2	22.6
32 A		41.5	41.1	40.5	40	39.4	38.9	38.3	37.7	37.1	36.5	35.9	35.3	34.7	34	33.4	32.7	32	31.3	30.6	29.9	29.1
40 A		53.7	52.9	52.2	51.4	50.6	49.8	49	48.2	47.3	46.5	45.6	44.7	43.8	42.9	42	41	40	39	37.9	36.9	35.8
45 A		60.8	60.1	59.2	58.3	57.4	56.5	55.5	54.6	53.6	52.6	51.6	50.5	49.5	48.4	47.3	46.2	45	43.8	42.6	41.4	40.1
50 A		65	64.3	63.5	62.6	61.7	60.8	59.9	59	58.1	57.1	56.2	55.2	54.2	53.2	52.1	51.1	50	48.9	47.8	46.7	45.5
63 A		85.5	84.6	83.3	82	80.7	79.4	78	76.7	75.3	73.9	72.4	70.9	69.4	67.9	66.3	64.7	63	61.3	59.5	57.8	56

Tertiary/Industry (IEC 60947-2) (cont.)

C60H-DC derating table (IEC 60947-2)

C60H-DC	Ambient temperature (°C)																				
Rating	-30	-25	-20	-15	-10	-5	0	+5	+10	+15	+20	+25	+30	+35	+40	+45	+50	+55	+60	+65	+70
0.5 A	0.63	0.62	0.61	0.6	0.59	0.58	0.56	0.55	0.54	0.53	0.51	0.5	0.49	0.47	0.46	0.44	0.43	0.41	0.39	0.38	0.36
1 A	1.18	1.17	1.15	1.14	1.12	1.1	1.09	1.07	1.05	1.04	1.02	1	0.98	0.96	0.94	0.92	0.9	0.88	0.86	0.84	0.82
2 A	2.54	2.5	2.45	2.41	2.36	2.31	2.26	2.21	2.16	2.11	2.06	2	1.94	1.88	1.82	1.76	1.7	1.63	1.56	1.48	1.41
3 A	3.78	3.71	3.65	3.58	3.51	3.45	3.38	3.3	3.23	3.16	3.08	3	2.92	2.84	2.75	2.66	2.57	2.48	2.38	2.27	2.17
4 A	5.08	4.99	4.9	4.81	4.71	4.62	4.52	4.42	4.32	4.22	4.11	4	3.89	3.77	3.65	3.53	3.4	3.27	3.13	2.98	2.83
5 A	6	5.92	5.83	5.74	5.66	5.57	5.48	5.39	5.29	5.2	5.1	5	4.9	4.8	4.69	4.58	4.47	4.36	4.24	4.12	4
6 A	7.26	7.15	7.04	6.94	6.83	6.71	6.6	6.48	6.37	6.25	6.12	6	5.87	5.74	5.61	5.47	5.33	5.19	5.04	4.89	4.73
10 A	12.6	12.4	12.2	11.9	11.7	11.5	11.3	11	10.8	10.5	10.3	10	9.7	9.5	9.2	8.9	8.6	8.3	7.9	7.6	7.2
13 A	15.5	15.3	15.1	14.9	14.6	14.4	14.2	14	13.7	13.5	13.3	13	12.8	12.5	12.2	12	11.7	11.4	11.1	10.8	10.5
15 A	18.6	18.3	18	17.7	17.4	17.1	16.7	16.4	16.1	15.7	15.4	15	14.6	14.3	13.9	13.5	13	12.6	12.2	11.7	11.2
16 A	19.4	19.1	18.9	18.6	18.3	18	17.6	17.3	17	16.7	16.3	16	15.7	15.3	14.9	14.6	14.2	13.8	13.4	13	12.5
20 A	24.1	23.7	23.4	23	22.7	22.3	21.9	21.6	21.2	20.8	20.4	20	19.6	19.2	18.7	18.3	17.9	17.4	16.9	16.4	15.9
25 A	30.4	29.9	29.5	29	28.5	28.1	27.6	27.1	26.6	26.1	25.5	25	24.5	23.9	23.3	22.7	22.1	21.5	20.9	20.2	19.6
30 A	37.4	36.7	36.1	35.5	34.9	34.2	33.5	32.9	32.2	31.5	30.7	30	29.2	28.5	27.7	26.8	26	25.1	24.2	23.2	22.3
32 A	38.5	37.9	37.4	36.8	36.2	35.7	35.1	34.5	33.9	33.3	32.6	32	31.4	30.7	30	29.3	28.6	27.9	27.1	26.3	25.5
40 A	48.9	48.2	47.4	46.7	45.9	45.1	44.3	43.5	42.6	41.8	40.9	40	39.1	38.2	37.2	36.2	35.2	34.2	33.1	32	30.8
50 A	59.9	59.1	58.3	57.4	56.5	55.6	54.7	53.8	52.9	52	51	50	49	48	46.9	45.9	44.8	43.6	42.5	41.3	40.1
63 A	78.2	76.9	75.6	74.3	73	71.7	70.3	68.9	67.5	66	64.5	63	61.4	59.8	58.2	56.5	54.7	52.9	51.1	49.1	47.1

C60PV-DC derating table (IEC 60947-2)

C60PV-DC	Ambient temperature (°C)																				
Rating	-30	-25	-20	-15	-10	-5	0	+5	+10	+15	+20	+25	+30	+35	+40	+45	+50	+55	+60	+65	+70
1 A	1.18	1.17	1.15	1.14	1.12	1.1	1.09	1.07	1.05	1.04	1.02	1	0.98	0.96	0.94	0.92	0.9	0.88	0.86	0.84	0.82
2 A	2.54	2.5	2.45	2.41	2.36	2.31	2.26	2.21	2.16	2.11	2.06	2	1.94	1.88	1.82	1.76	1.7	1.63	1.56	1.48	1.41
3 A	3.78	3.71	3.65	3.58	3.51	3.45	3.38	3.3	3.23	3.16	3.08	3	2.92	2.84	2.75	2.66	2.57	2.48	2.38	2.27	2.17
5 A	6	5.92	5.83	5.74	5.66	5.57	5.48	5.39	5.29	5.2	5.1	5	4.9	4.8	4.69	4.58	4.47	4.36	4.24	4.12	4
8 A	9.64	9.5	9.36	9.22	9.08	8.93	8.78	8.63	8.48	8.32	8.16	8	7.83	7.67	7.49	7.31	7.13	6.95	6.76	6.56	6.36
10 A	12.6	12.4	12.2	11.9	11.7	11.5	11.2	11	11.8	10.5	10.3	10	9.7	9.4	9.2	9.9	8.6	8.2	7.9	7.6	7.2
13 A	15.5	15.3	15.1	14.8	14.6	14.4	14.2	14	13.7	13.5	13.2	13	12.7	12.5	12.2	12	11.7	11.4	11.1	10.8	10.5
15 A	18.6	18.3	18	17.7	17.4	17.1	16.7	16.4	16.1	16.7	15.4	15	14.6	14.3	13.9	13.5	13	12.6	12.2	11.7	11.2
16 A	19.4	19.1	18.9	18.6	18.3	18	17.6	17.3	17	16.7	16.3	16	15.7	15.3	14.9	14.6	14.2	13.8	13.4	13	12.5
20 A	24.1	23.7	23.4	23	22.7	22.3	21.9	21.6	21.2	20.8	20.4	20	19.6	19.2	18.7	18.3	17.9	17.4	16.9	16.4	15.9
25 A	30.4	29.9	29.5	29	28.5	28.1	27.6	27.1	26.6	26.1	25.5	25	24.5	23.9	23.3	22.7	22.1	21.5	20.9	20.2	19.6
30 A	37.4	36.7	36.1	35.5	34.9	34.2	33.5	32.9	32.2	31.5	30.7	30	29.2	28.5	27.7	26.8	26	25.1	24.2	23.2	22.3

C120 derating table (IEC 60947-2)

C120	Ambient temperature (°C)																				
Rating	-30	-25	-20	-15	-10	-5	0	+5	+10	+15	+20	+25	+30	+35	+40	+45	+50	+55	+60	+65	+70
10 A	14.5	14.3	14	13.8	13.5	13.3	13	12.7	12.5	12.2	11.9	11.6	11.3	11	10.7	10.3	10	9.7	9.3	8.9	8.5
16 A	21.2	21	20.7	20.4	20.1	19.8	19.4	19.1	18.8	18.5	18.2	17.8	17.5	17.1	16.8	16.4	16	15.6	15.2	14.8	14.4
20 A	27	26.6	26.3	25.9	25.5	25	24.6	24.2	23.8	23.3	22.9	22.4	22	21.5	21	20.5	20	19.5	18.9	18.4	17.8
25 A	33.7	33.3	32.8	32.3	31.8	31.3	30.8	30.2	29.7	29.1	28.6	28	27.5	26.9	26.3	25.6	25	24.4	23.7	23	22.3
32 A	42.7	42.1	41.5	40.9	40.3	39.7	39	38.4	37.7	37.1	36.4	35.7	35	34.3	33.5	32.8	32	31.2	30.4	29.6	28.7
40 A	54.8	54	53.2	52.4	51.5	50.7	49.8	48.9	48	47.1	46.1	45.2	44.2	43.2	42.1	41.1	40	38.9	37.7	36.6	35.3
50 A	69.1	68.1	67	65.9	64.8	63.7	62.6	61.5	60.3	59.1	57.9	56.7	55.4	54.1	52.8	51.4	50	48.6	47.1	45.5	43.9
63 A	87.1	85.8	84.5	83.1	81.8	80.4	78.9	77.5	76	74.5	73	71.4	69.8	68.2	66.5	64.8	63	61.2	59.3	57.4	55.4
80 A	103.7	102.4	101	99.7	98.3	96.9	95.5	94.1	92.6	91.1	89.6	88.1	86.5	84.9	83.3	81.7	80	78.3	76.5	74.7	72.9
100 A	137.6	135.5	133.5	131.4	129.2	127.1	124.8	122.6	120.3	118	115.6	113.1	110.6	108.1	105.5	102.8	100	97.2	94.2	91.2	88.1
125 A	174.6	171.9	169.2	166.4	163.6	160.7	157.8	154.9	151.8	148.7	145.6	142.4	139.1	135.7	132.2	128.7	125	121.2	117.3	113.3	109.1

Tertiary/Industry (IEC 60947-2) (cont.)

NG125 derating table (IEC 60947-2)

NG125	Ambient temperature (°C)																				
Rating	-30	-25	-20	-15	-10	-5	0	+5	+10	+15	+20	+25	+30	+35	+40	+45	+50	+55	+60	+65	+70
10 A	13.7	13.5	13.2	13	12.8	12.5	12.3	12	11.7	11.5	11.2	10.9	10.6	10.3	10	9.7	9.4	9	8.7	8.3	7.9
16 A	20.3	20.1	19.8	19.5	19.2	18.9	18.6	18.3	18	17.7	17.4	17	16.7	16.4	16	15.7	15.3	14.9	14.5	14.1	13.7
20 A	26	25.6	25.3	24.9	24.5	24	23.6	23.2	22.8	22.3	21.9	21.4	21	20.5	20	19.5	19	18.5	17.9	17.4	16.8
25 A	33.8	33.2	32.7	32.1	31.5	30.9	30.3	29.7	29.1	28.4	27.8	27.1	26.4	25.7	25	24.3	23.5	22.7	21.9	21	20.1
32 A	41.2	40.6	40	39.4	38.8	38.2	37.5	36.9	36.2	35.6	34.9	34.2	33.5	32.7	32	31.2	30.5	29.7	28.8	28	27.1
40 A	53.5	52.7	51.8	51	50.1	49.1	48.2	47.3	46.3	45.3	44.3	43.3	42.2	41.1	40	38.9	37.7	36.5	35.2	33.9	32.5
50 A	66.3	65.2	64.2	63.1	62.1	61	59.8	58.7	57.5	56.4	55.1	53.9	52.6	51.3	50	48.6	47.2	45.8	44.3	42.7	41.1
63 A	83.4	82.1	80.8	79.5	78.1	76.8	75.4	73.9	72.5	71	69.5	67.9	66.3	64.7	63	61.3	59.5	57.7	55.8	53.9	51.8
80 A	100.4	99.1	97.8	96.4	95	93.6	92.2	90.8	89.3	87.8	86.3	84.8	83.2	81.6	80	78.3	76.6	74.9	73.1	71.3	69.4
100 A	133.4	131.3	129.1	127	124.8	122.5	120.2	117.9	115.5	113.1	110.6	108	105.4	102.7	100	97.2	94.3	91.3	88.2	85	81.6
125 A	165.2	162.7	160.1	157.5	154.8	152.1	149.3	146.5	143.6	140.7	137.7	134.6	131.5	128.3	125	121.6	118.1	114.6	110.9	107	103.1

Tertiary/Industry (IEC 60947-3)

SW60-DC derating table (IEC 60947-3)

SW60PV-DC	Ambient temperature (°C)											
Rating	+5	+10	+15	+20	+25	+30	+35	+40	+45	+50	+60	+70
50 A	63	61	60	58	56	54	52	50	48	46	41	35

iC60H RCBO derating table (IEC 61009-1)

iC60H RCBO	Ambient temperature (°C)															
Rating	-15	-10	-5	0	+5	+10	+15	+20	+25	+30	+35	+40	+45	+50	+55	+60
6 A	8.3	8.15	7.99	7.83	7.67	7.50	7.33	7.16	6.98	6.79	6.6	6.41	6.21	6	5.78	5.56
10 A	12.9	12.7	12.5	12.3	12.1	11.9	11.6	11.4	11.2	11	10.7	10.5	10.3	10	9.7	9.5
16 A	20.9	20.6	20.3	19.9	19.6	19.2	18.8	18.4	18.1	17.7	17.3	16.9	16.4	16	15.6	15.1
20 A	26.3	25.9	25.4	25	24.5	24.1	23.6	23.1	22.6	22.1	21.6	21.1	20.6	20	19.4	18.8
25 A	31.5	31	30.6	30.1	29.6	29.2	28.7	28.2	27.7	27.2	26.6	26.1	25.6	25	24.4	23.8
32 A	39.2	38.7	38.2	37.7	37.2	36.6	36.1	35.5	35	34.4	33.8	33.2	32.6	32	31.4	30.7
40 A	50.2	49.5	48.8	48	47.3	46.5	45.8	45	44.2	43.4	42.6	41.7	40.9	40	39.1	38.2
45 A	55.5	54.7	54	53.2	52.5	51.7	50.9	50.1	49.3	48.5	47.6	46.8	45.9	45	41.9	41

Switches

- In all cases, the switches are correctly protected against overloads by a circuit breaker with a lower or equal rating, operating at the same ambient temperature.

iCT contactors

In the case of contactor mounting in an enclosure for which the interior temperature is in a range between 50°C and 60°C, it is necessary to use a spacer, cat. no. A9A27062, between each contactor.

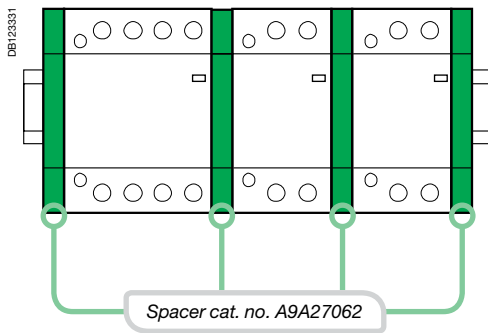

Splitter blocks

In the event of a temperature higher than 40°C, the maximum acceptable current is limited to the values in the table below:

Type	Temperature				
	40°C	45°C	50°C	55°C	60°C
Multiclip 80 A	80	76	73	69	66
Distribloc 63 A	63	60	58	55	53

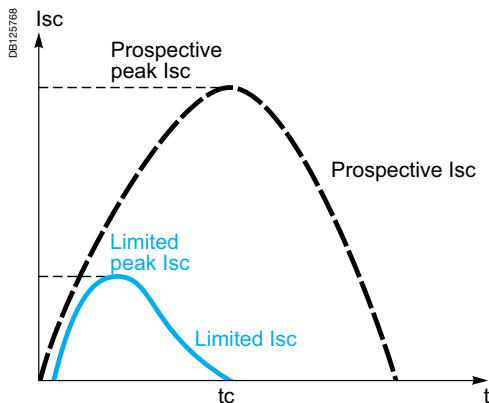

Prospective current and real limit current.

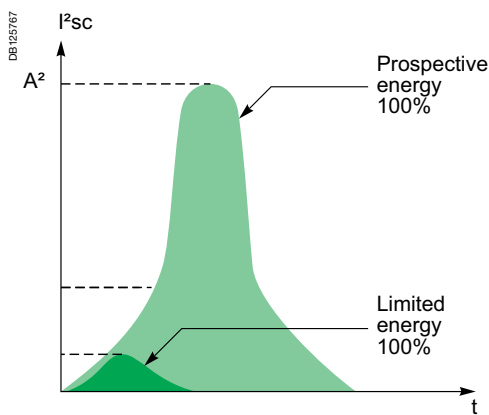

Definition

The limiting capacity of a circuit breaker is its ability to lessen the effects of a short circuit on an electrical installation by reducing the current amplitude and the dissipated power.

Benefits of limiting

Long installation service life

Thermal effects

Lower temperature rise at the conductor level, hence increased service life for cables and all components that are not self-protected (e.g. switches, contactors, etc.)

Mechanical effects

Lower electrodynamic repulsion forces, hence less risk of deformation or breakage of electrical contacts and busbars.

Electromagnetic effects

Less interference on sensitive equipment located in the vicinity of an electric circuit.

Savings through cascading

Cascading is a technique derived directly from current limiting: downstream of a current-limiting circuit breaker it is possible to use circuit breakers of breaking capacity lower than the prospective short-circuit current (in line with the cascading tables). The breaking capacity is heightened thanks to current limiting by the upstream device. Substantial savings can be achieved in this way on switchgear and enclosures.

Discrimination of protection devices

The circuit breakers' current limiting capacity improves discrimination with the protection devices located upstream: this is because the required energy passing through the upstream protection device is greatly reduced and can be not enough to cause it to trip. Discrimination can thus be natural without having to install a time-delayed protection device upstream.

Acti 9 circuit breaker current limiting

Profiting from Schneider Electric's experience and expertise in the field of short-circuit current breaking, the circuit breakers of the Acti 9 range have a top-level current limiting characteristic for modular devices.

This assures them of optimal protection of the entire power distribution system.

Representation: Current limiting curves

The current limiting capacity of a circuit breaker is reflected by 2 curves which give, as a function of the prospective short-circuit current (current which would flow in the absence of a protection device):

- the real peak current (limited)
- the thermal stress (in A²s), this value, multiplied by the resistance of any element through which the short-circuit current passes, gives the power dissipated by this element.

The straight line "10 ms" representing the energy A²s of a prospective short-circuit current of a half-period (10 ms) indicates the energy that would be dissipated by the short-circuit current in the absence of limiting by the protection device (see example).

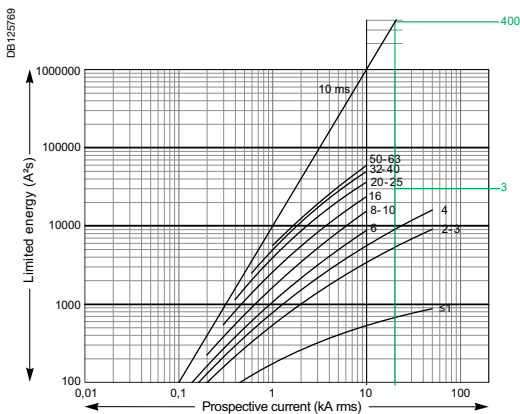

Example

What is the energy limited by an iC60N 25 A circuit breaker for a prospective short-circuit current of 10 kA rms. What is the quality of current limiting?

> as shown in the graph opposite:

- this short-circuit current (10 kA rms) is likely to dissipate up to 1,000 kA²s
- the iC60N circuit breaker reduces this thermal stress to: 35 kA²s, which is 22 times less.

Example of use: Stresses acceptable by the cables

The following table shows the thermal stresses acceptable by the cables depending on their insulation, their composition (Cu or Al) and their cross section. Cross-section values are expressed in mm² and stresses in A²s.

S (mm ²)		1.5	2.5	4	6	10
PVC	Cu	2.97 x 10 ⁴	8.26 x 10 ⁴	2.12 x 10 ⁵	4.76 x 10 ⁵	1.32 x 10 ⁶
	Al					5.41 x 10 ⁵
PRC	Cu	4.10 x 10 ⁴	1.39 x 10 ⁵	2.92 x 10 ⁵	6.56 x 10 ⁵	1.82 x 10 ⁶
	Al					7.52 x 10 ⁵
S (mm ²)		16	25	35	50	
PVC	Cu	3.4 x 10 ⁶	8.26 x 10 ⁶	1.62 x 10 ⁷	3.21 x 10 ⁷	
	Al	1.39 x 10 ⁶	3.38 x 10 ⁶	6.64 x 10 ⁶	1.35 x 10 ⁷	
PRC	Cu	4.69 x 10 ⁶	1.39 x 10 ⁷	2.23 x 10 ⁷	4.56 x 10 ⁷	
	Al	1.93 x 10 ⁶	4.70 x 10 ⁶	9.23 x 10 ⁶	1.88 x 10 ⁷	

Example

Is a Cu/PVC cable of cross section 10 mm² protected by a NG125L device?

The above table shows that the acceptable stress is 1.32 x 10⁶ A²s. Any short-circuit current at the point where a NG125L device (I_{cu} = 25 kA) is installed will be limited, with a thermal stress of less than 2.2 x 10⁵ A²s. (Curve on page 11/26).

The cable is therefore always protected up to the breaking capacity of the circuit breaker.

Limitation curves for network
 U_e: 380-415 V AC (Ph/N 220-240 V AC)

iDPN (MCB and RCBO)

1P+N / 3P / 3P+N

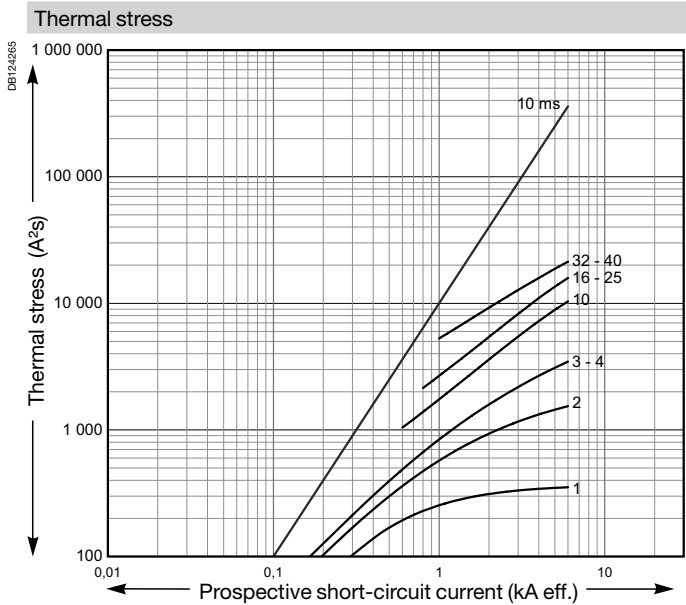
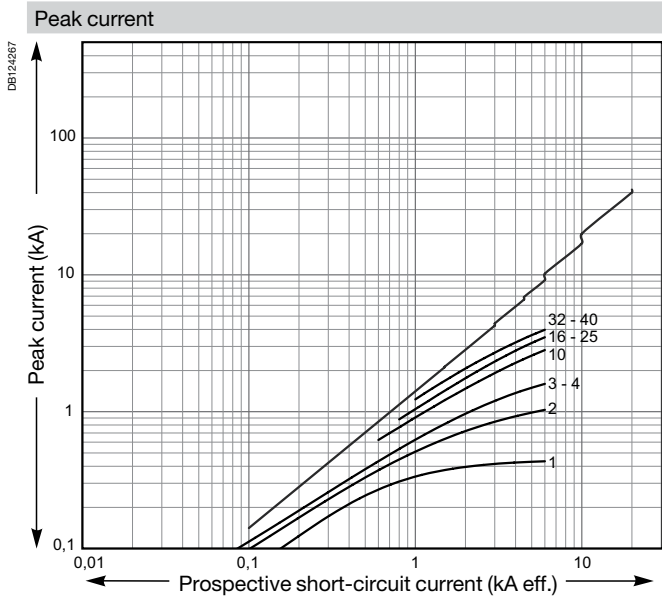

DPN N (MCB and RCBO)

1P+N / 3P / 3P+N

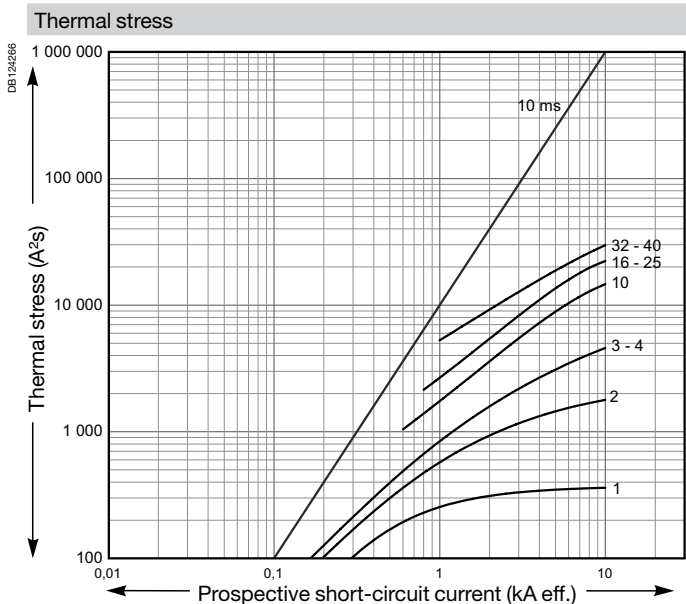
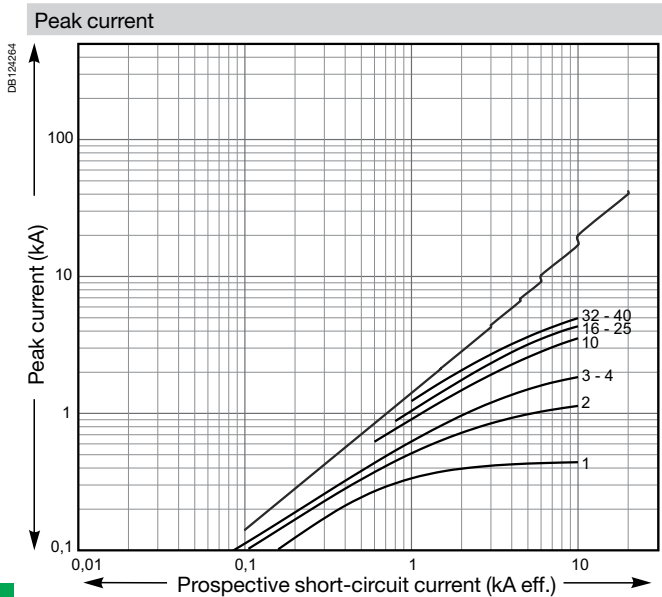

Limitation curves for network
 U_e: 380-415 V AC (Ph/N 220-240 V AC)

iC60N

1P / 1P+N / 2P / 3P / 4P

Peak current

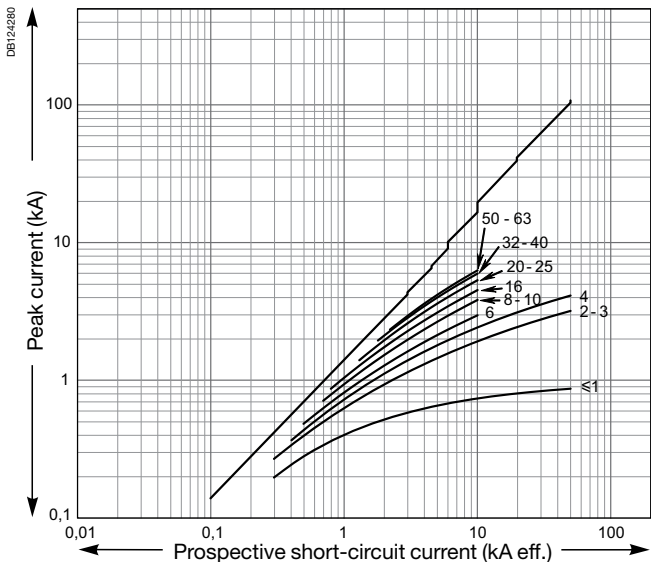

Thermal stress

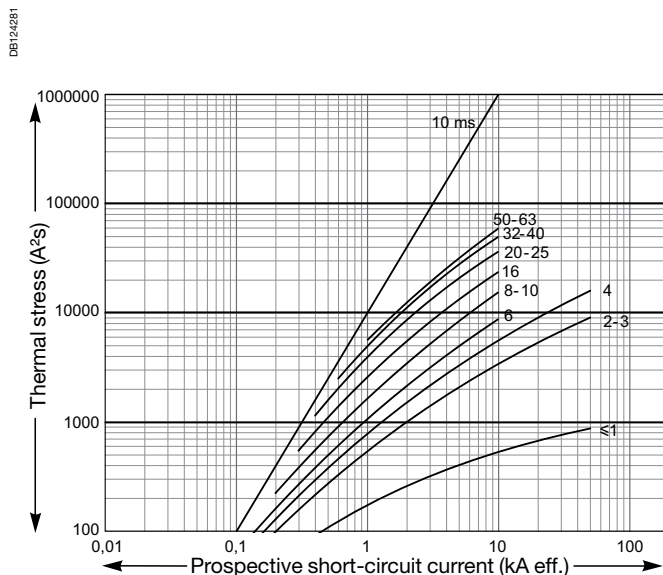

iC60H

1P / 1P+N / 2P / 3P / 4P

Peak current

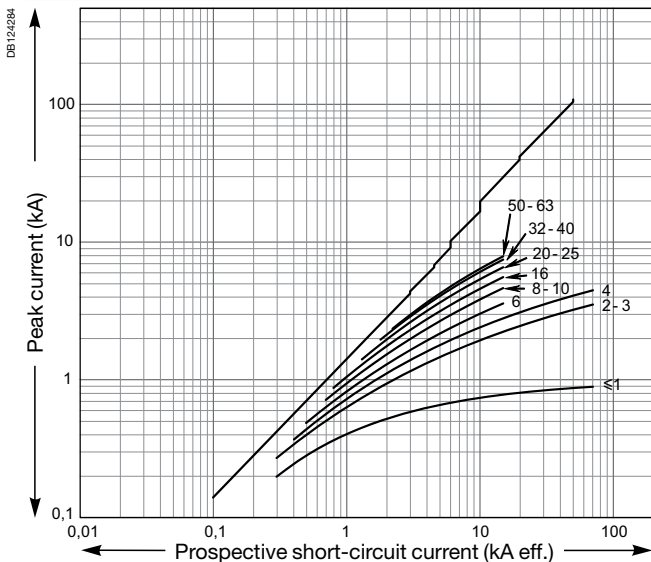

Thermal stress

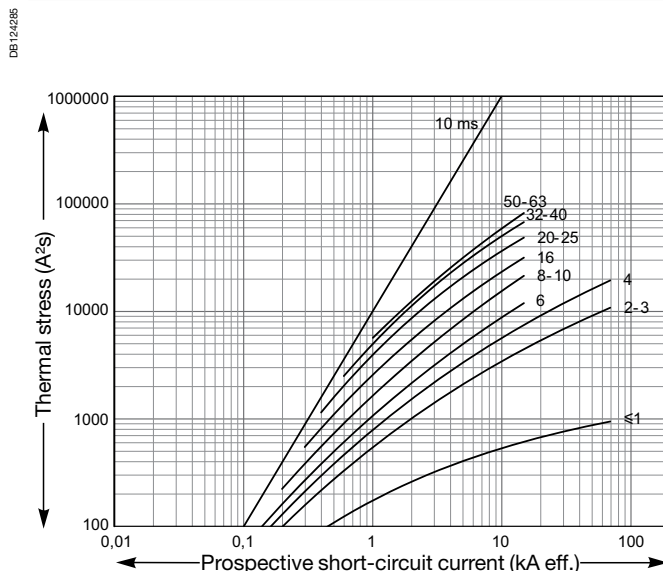

Limitation curves for network

U_e: 380-415 V AC (Ph/N 220-240 V AC)

iC60L

1P / 2P / 3P / 4P

Peak current

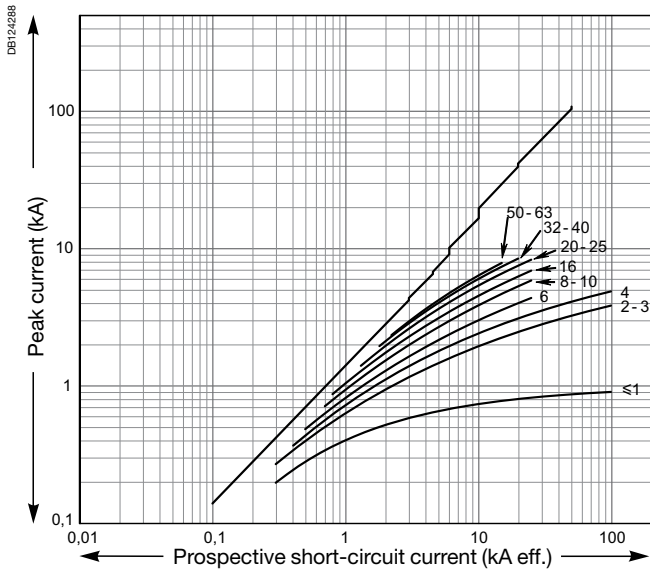

Thermal stress

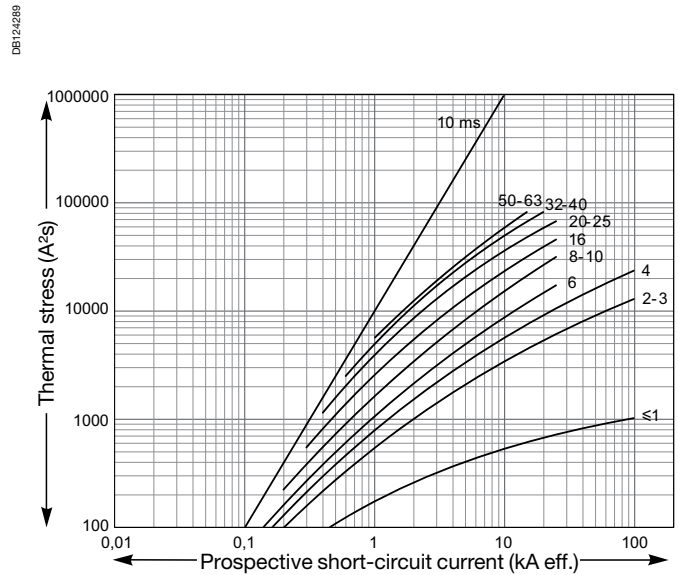

Limitation curves for network
 Ue: 380-415 V AC (Ph/N 220-240 V AC)

C60a

1P / 2P / 3P / 3P+N / 4P

Peak current

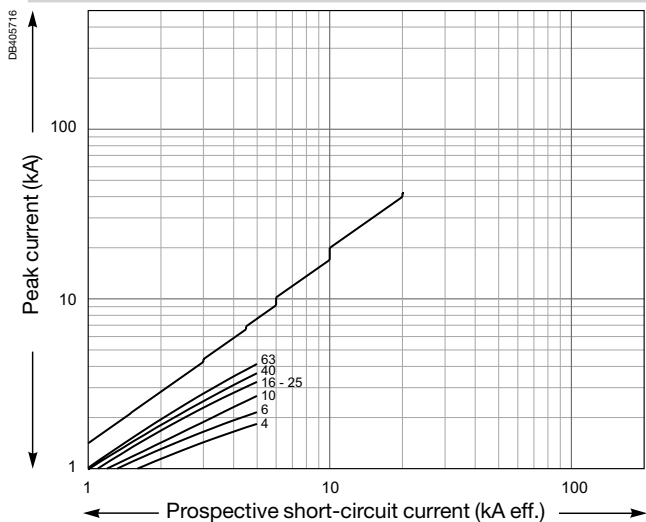

Thermal stress

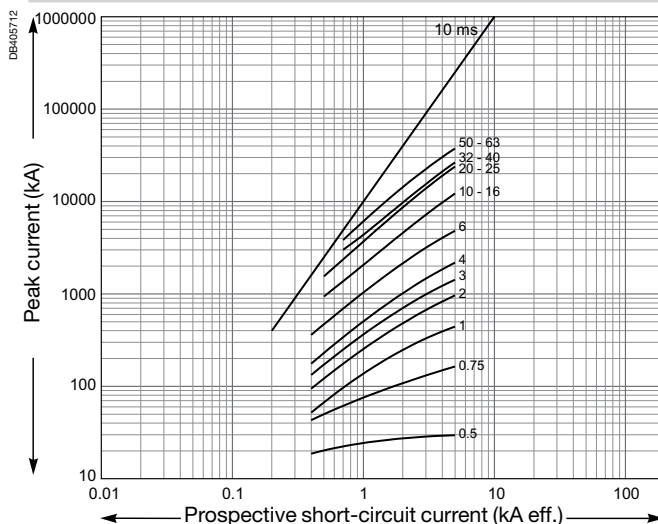

C60N

1P / 1P+N / 2P / 3P / 3P+N / 4P

Peak current

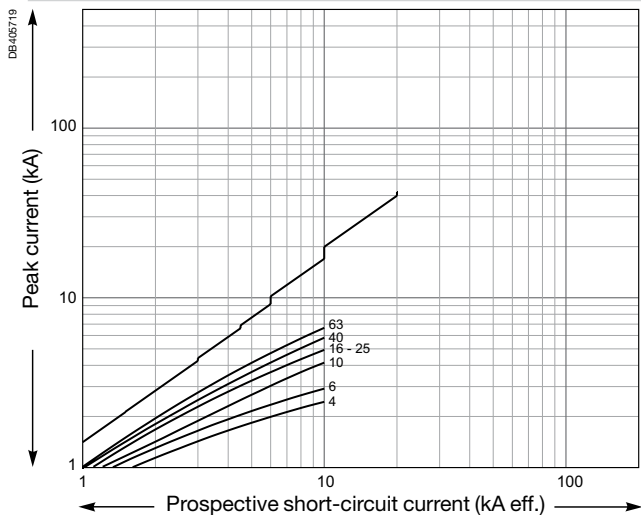

Thermal stress

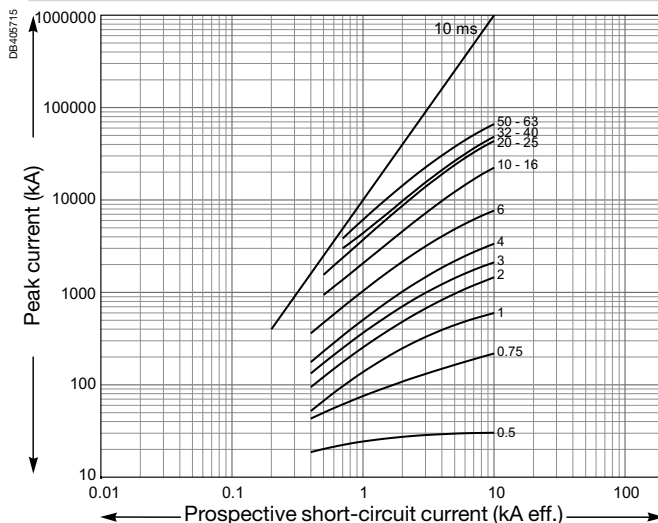

Limitation curves for network
 Ue: 380-415 V AC (Ph/N 220-240 V AC)

iC60H

1P / 1P+N / 2P / 3P / 3P+N / 4P

Peak current

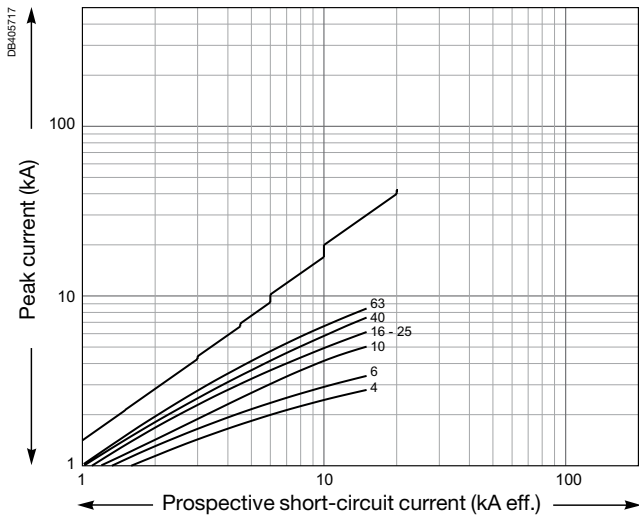

Thermal stress

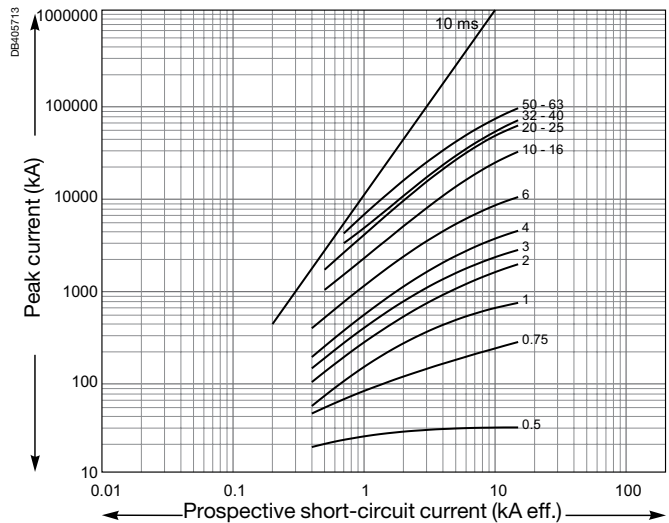

C60L

1P / 2P / 3P / 4P

Peak current

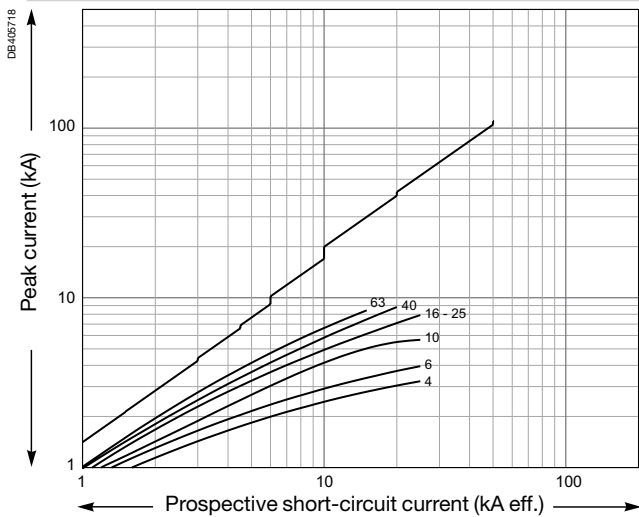

Thermal stress

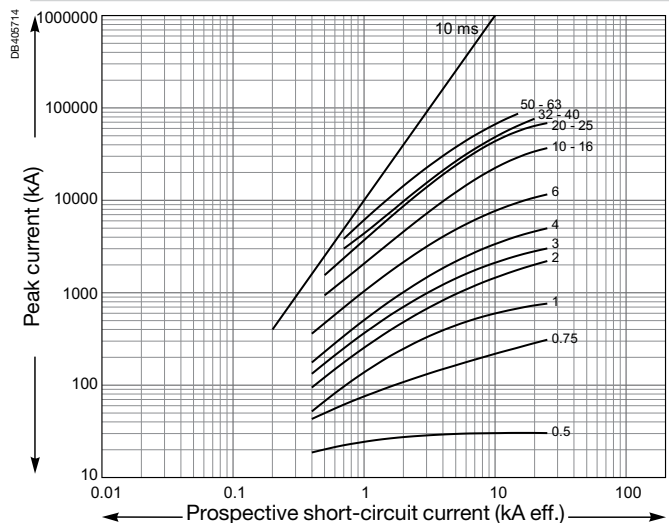

Limitation curves for network
 U_e: 380-415 V AC (Ph/N 220-240 V AC)

C120N, H

1P / 2P / 3P / 4P

Peak current

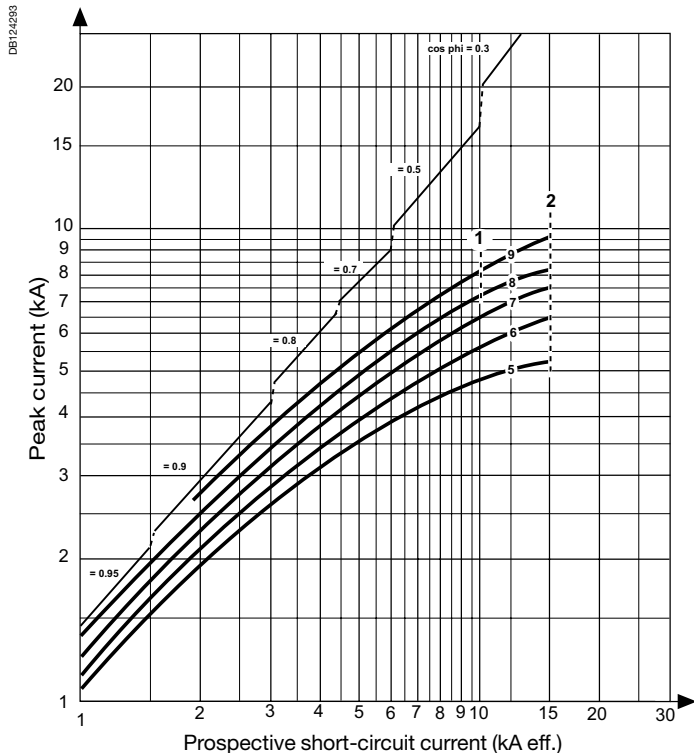

■ Circuit breaker type in accordance with the mark:

- 1: C120N
- 2: iC120H
- 5: 10-16 A
- 6: 20-25 A
- 7: 32-40 A
- 8: 50-63 A
- 9: 80-125 A

Thermal stress

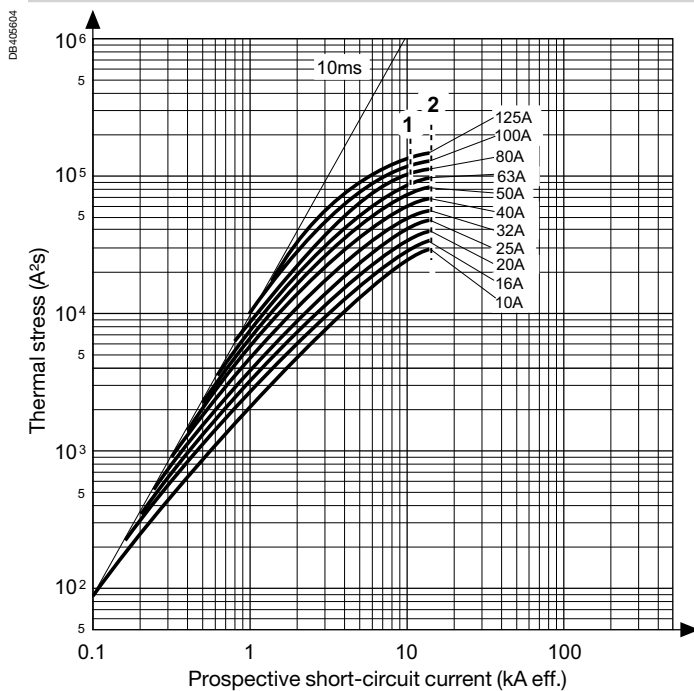

■ Circuit breaker type in accordance with the mark:

- 1: C120N
- 2: iC120H

Limitation curves for network
 U_e: 380-415 V AC (Ph/N 220-240 V AC)

NG125a, N, H, L

1P / 2P / 3P / 4P

Peak current

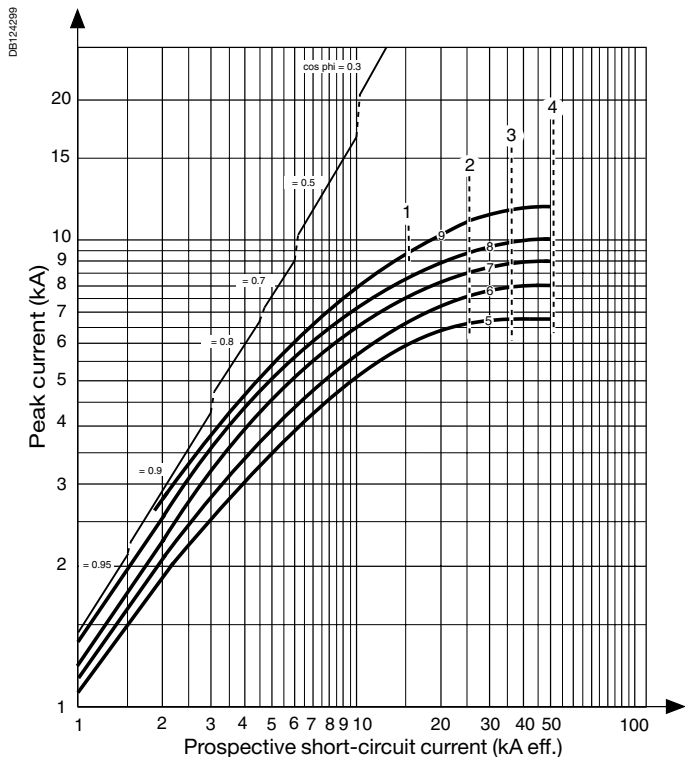

■ Circuit breaker type in accordance with the mark:

- 1: NG125a
- 2: NG125N
- 3: NG125H
- 4: NG125L
- 5: 10 -16 A
- 6: 20-25 A
- 7: 32-40 A
- 8: 50-63 A
- 9: 80-125 A

Thermal stress

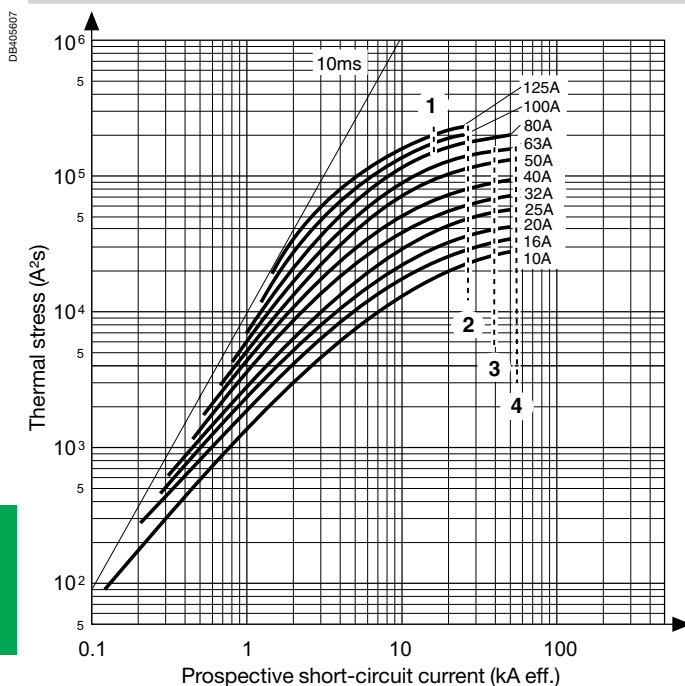

■ Circuit breaker type in accordance with the mark:

- 1: NG125a 80-100-125 A
- 2: NG125N
- 3: NG125H
- 4: NG125L

Limitation curves for network
U_e: 440 V AC

C60N

2P / 3P / 4P

Peak current

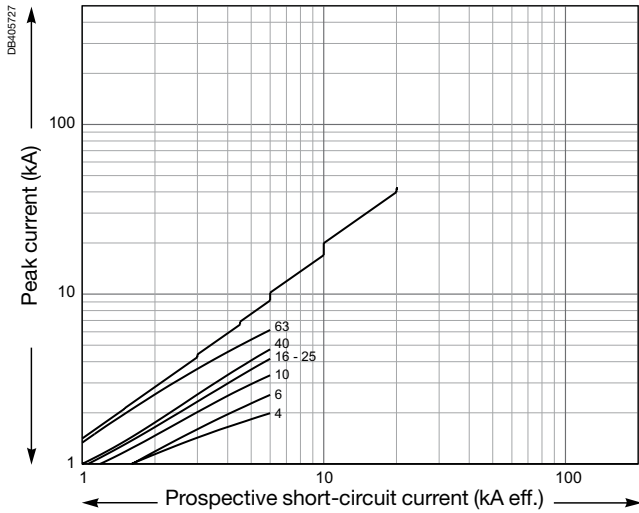

Thermal stress

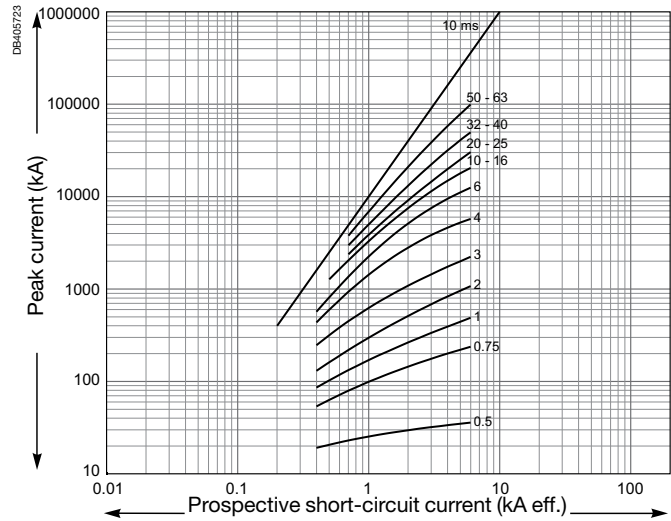

Limitation curves for network
U_e: 440 V AC

iC60H

2P / 3P / 4P

Peak current

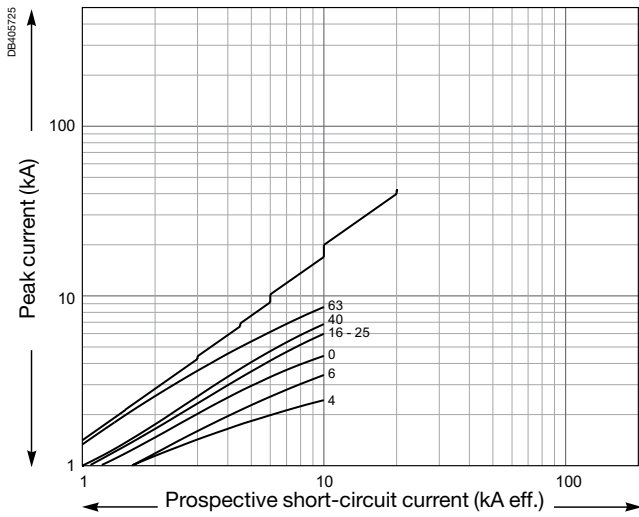

Thermal stress

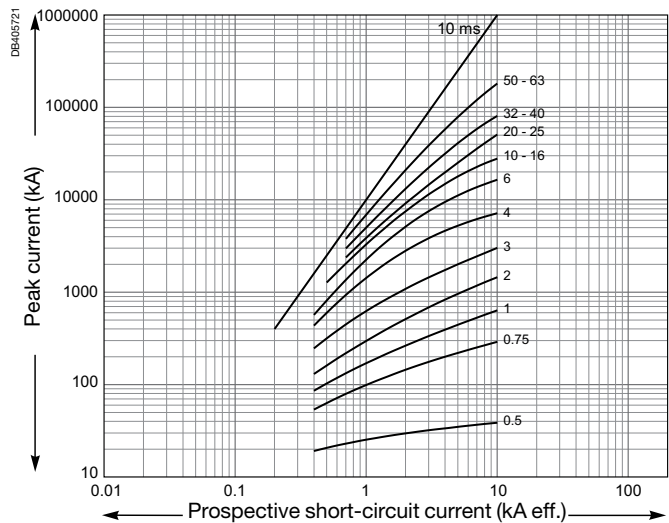

C60L

2P / 3P / 4P

Peak current

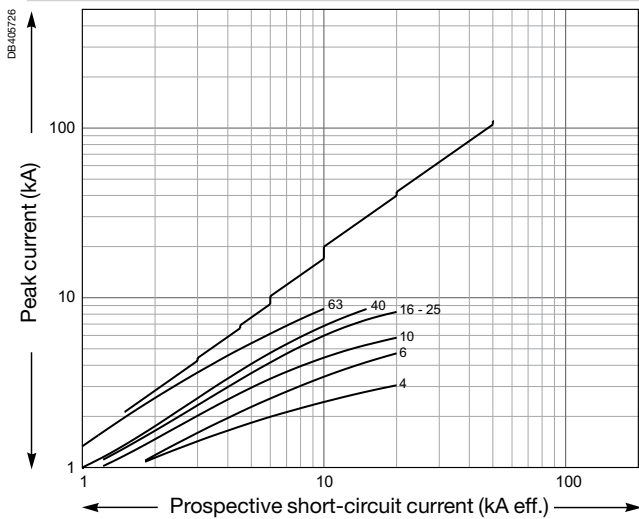

Thermal stress

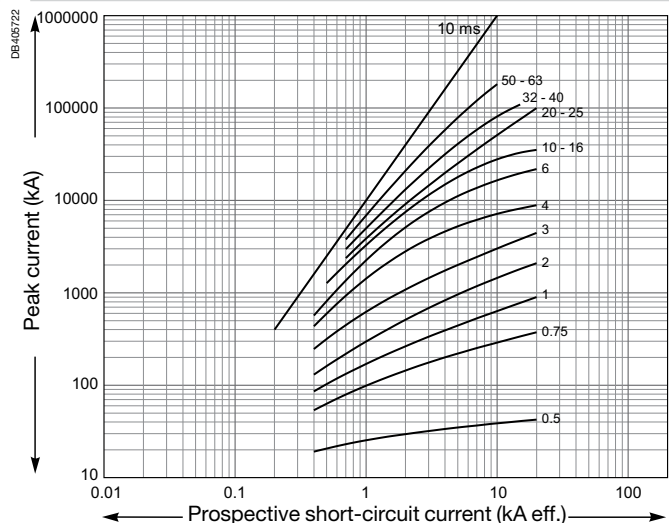

Limitation curves for network
Ue: 440 V AC

C120N, H

2P / 3P / 4P

Peak current

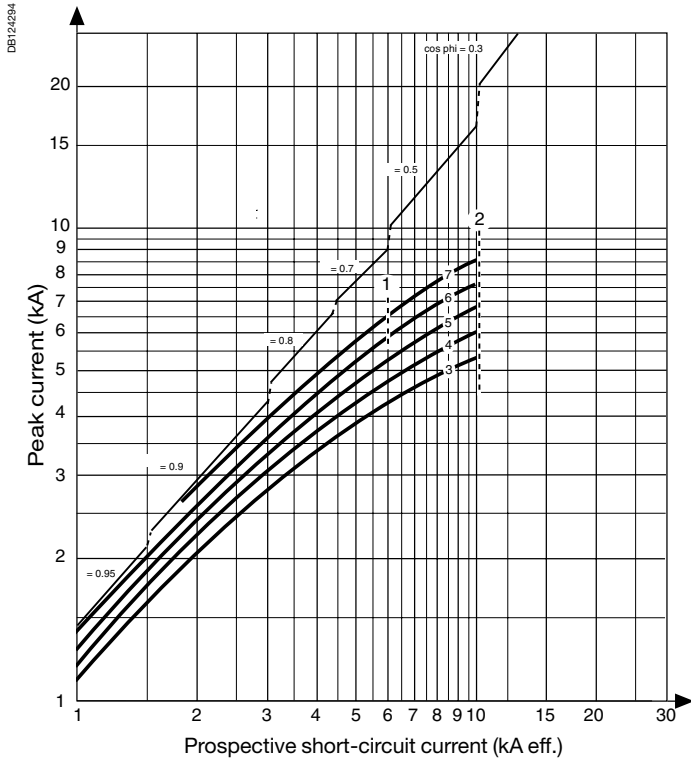

■ Circuit breaker type in accordance with the mark:

- 1: C120N
- 2: iC120H
- 3: 0-16 A
- 4: 20-25 A
- 5: 32-40 A
- 6: 50-63 A
- 7: 80-125 A

Thermal stress

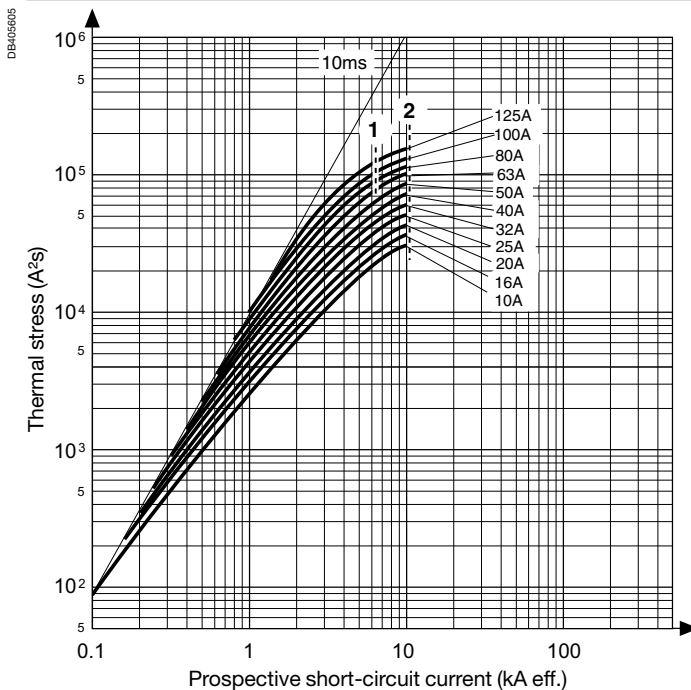

■ Circuit breaker type in accordance with the mark:

- 1: C120N
- 2: iC120H

Limitation curves for network

U_e: 550 V AC

NG125a, N, H, L

2P / 3P / 4P

Peak current

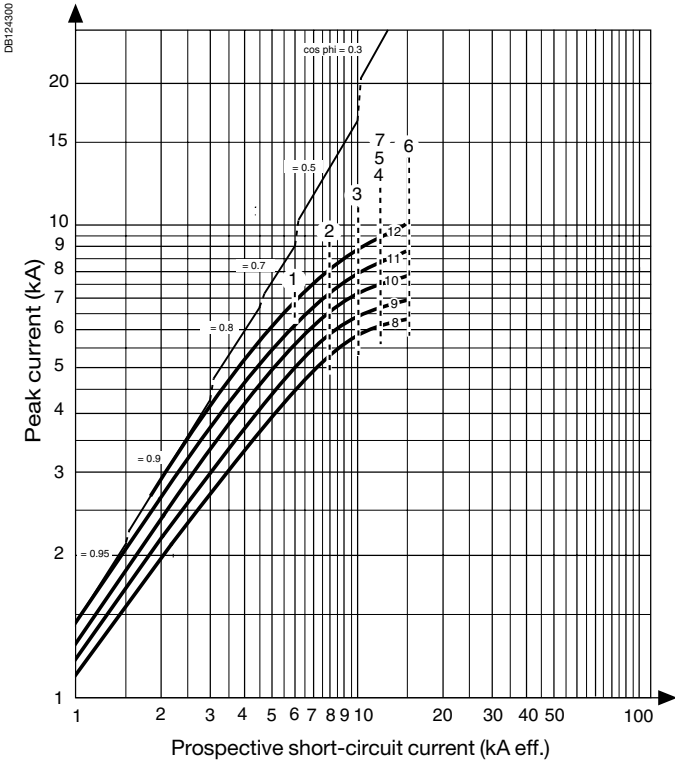

■ Circuit breaker type in accordance with the mark:

- 1: NG125a 3, 4P
- 2: NG125N 2, 3, 4P
- 3: NG125H 3, 4P
- 4-5: NG125H 2P/NG125L 3, 4P
- 6: NG125L 2P
- 7: NG125 LMA 2, 3, 4P
- 8: 10 -16 A
- 9: 20-25 A
- 10: 32-40 A
- 11: 50-63 A
- 12: 80-125 A

Thermal stress

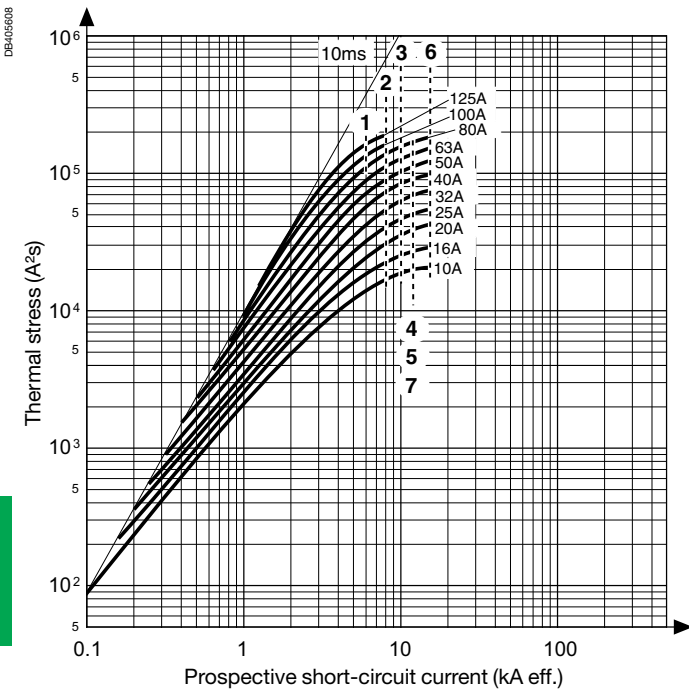

■ Circuit breaker type in accordance with the mark:

- 1: NG125a 3, 4P
- 2: NG125N 2, 3, 4P
- 3: NG125H 3, 4P
- 4-5: NG125H 2P/NG125L 3, 4P
- 6: NG125L 2P
- 7: NG125LMA 2, 3, 4P

Limitation curves for network
 U_e: 220-240 V AC (Ph/N 110-130 V AC)

C60a

1P / 2P / 3P / 3P+N / 4P

Peak current

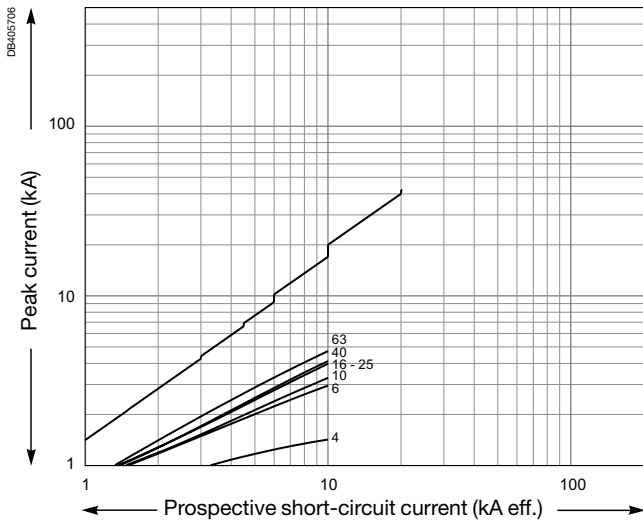

Thermal stress

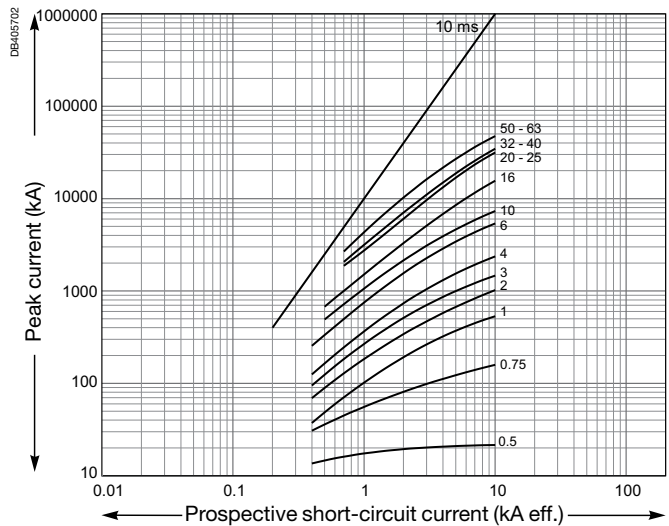

C60N

1P / 1P+N / 2P / 3P / 3P+N / 4P

Peak current

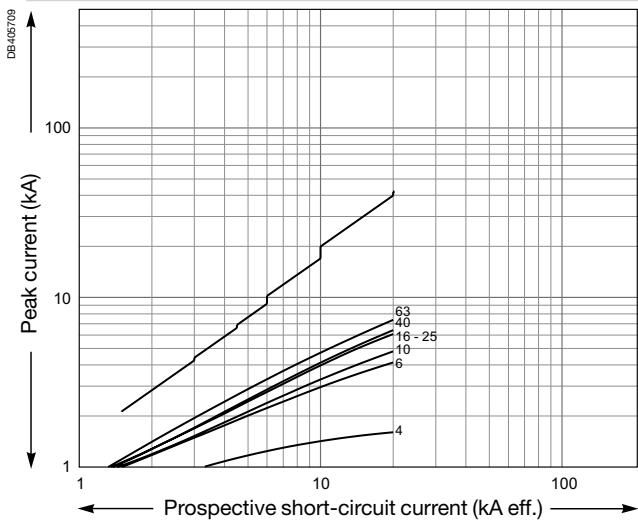

Thermal stress

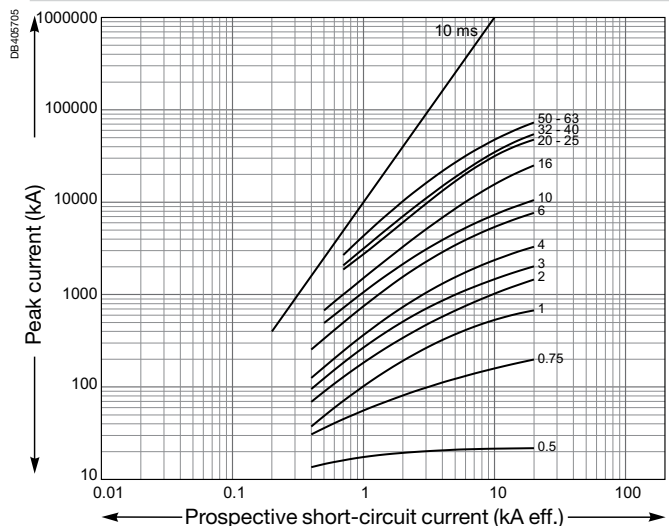

Limitation curves for network
 U_e: 220-240 V AC (Ph/N 110-130 V AC)

iC60H

1P / 1P+N / 2P / 3P / 3P+N / 4P

Peak current

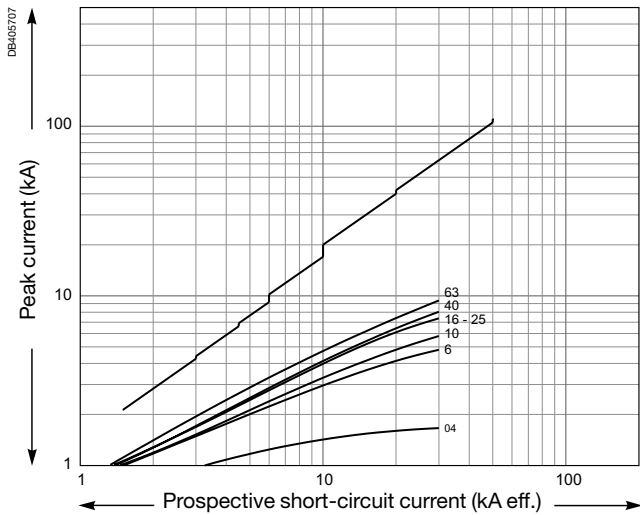

Thermal stress

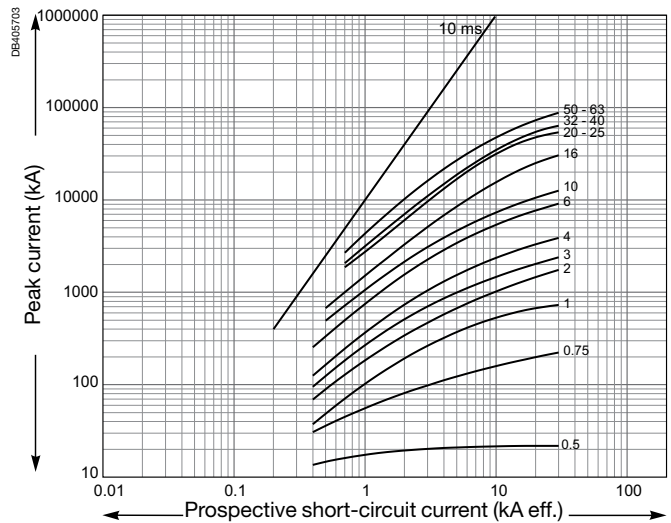

C60L

1P / 2P / 3P / 4P

Peak current

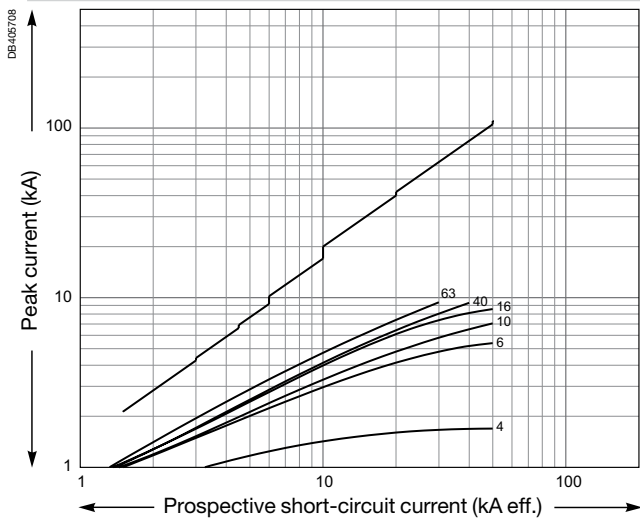

Thermal stress

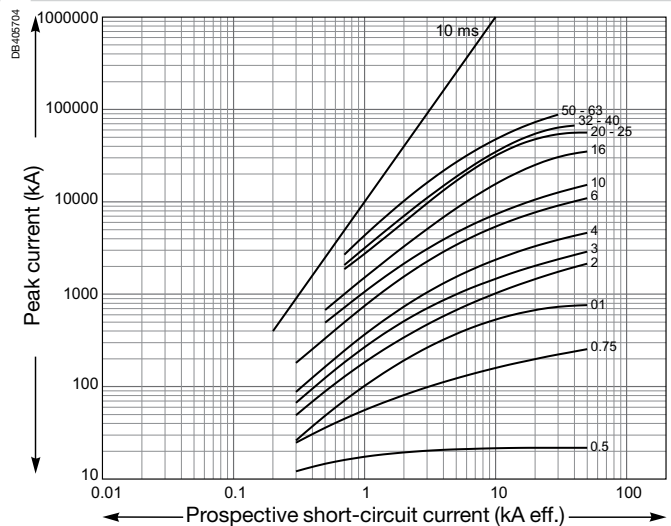

Limitation curves for network

U_e: 220-240 V AC (Ph/N 110-130 V AC)

C120N, H

1P / 2P / 3P / 4P

Peak current

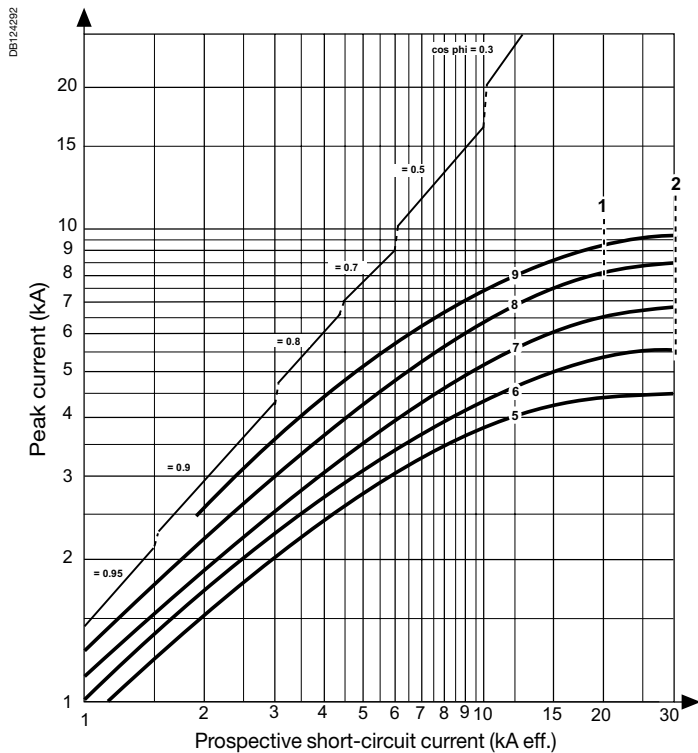

■ Circuit breaker type in accordance with the mark:

- 1: C120N
- 2: iC120H
- 5: 10-16 A
- 6: 20-25 A
- 7: 32-40 A
- 8: 50-63 A
- 9: 80-125 A

Thermal stress

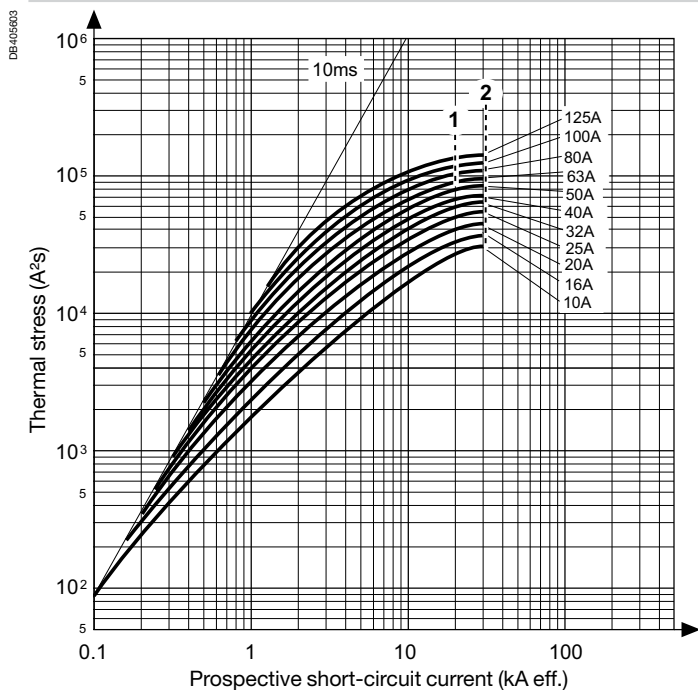

■ Circuit breaker type in accordance with the mark:

- 1: C120N
- 2: iC120H

Limitation curves for network
 Ue: 220-240 V AC (Ph/N 110-130 V AC)

NG125a, N, H, L

1P / 2P / 3P / 4P

Peak current

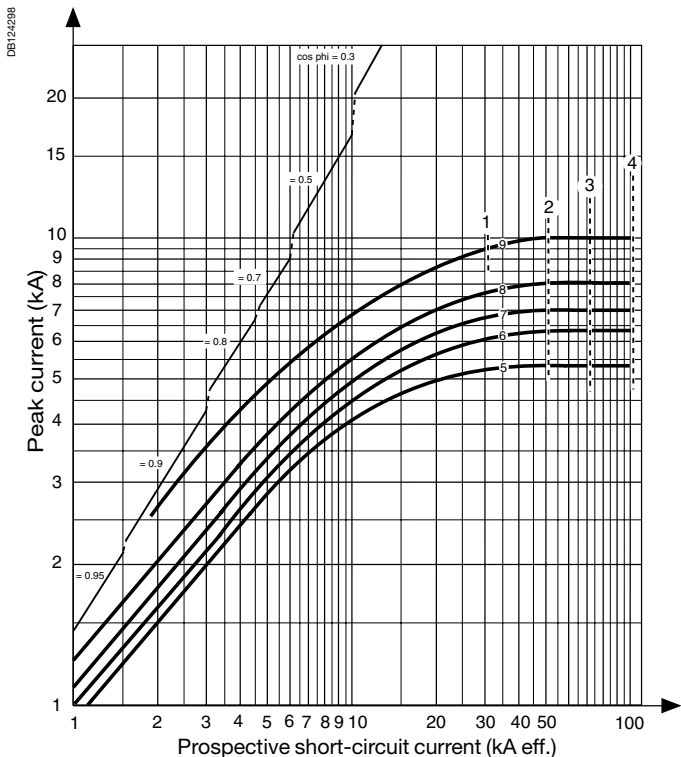

- Circuit breaker type in accordance with the mark:
- 1: NG125a
- 2: NG125N
- 3: NG125H
- 4: NG125L
- 5: 10-16 A
- 6: 20-25 A
- 7: 32-40 A
- 8: 50-63 A
- 9: 80-125 A

Thermal stress

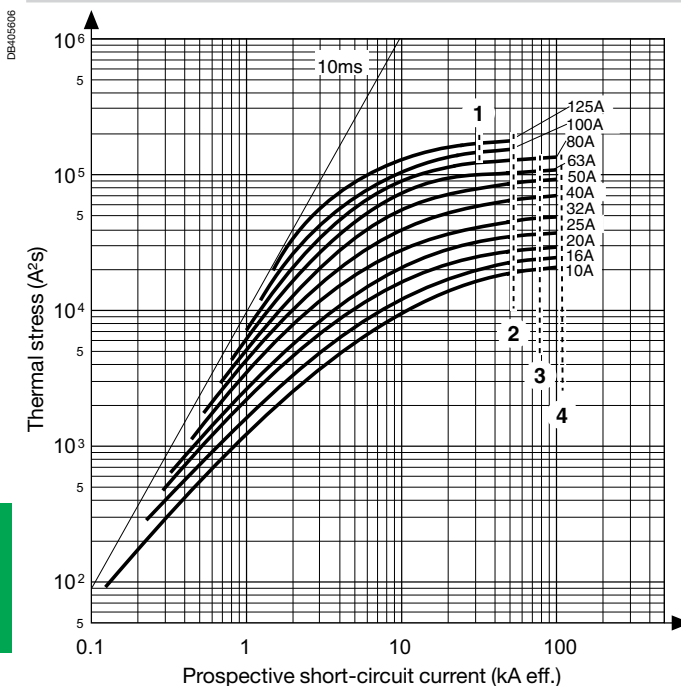

- Circuit breaker type in accordance with the mark:
- 1: NG125a 80-100-125 A
- 2: NG125N
- 3: NG125H
- 4: NG125L

Limitation curves for direct current network

C60H-DC curve C

1P (220 V) - 2P (440 V)

Peak current

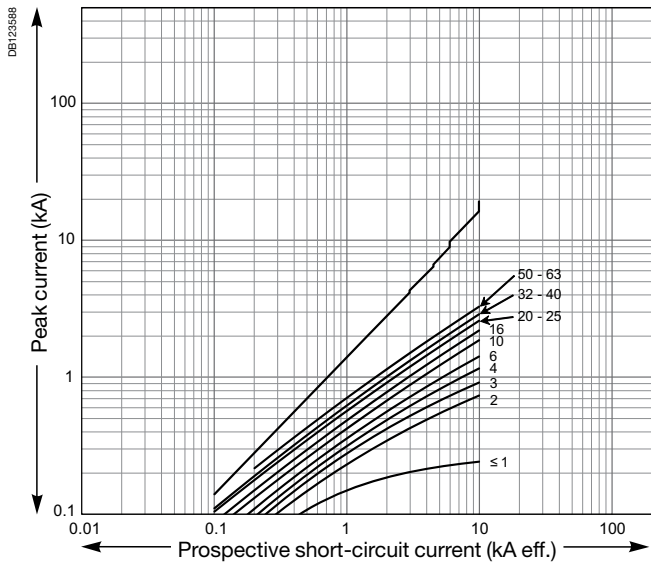

Thermal stress

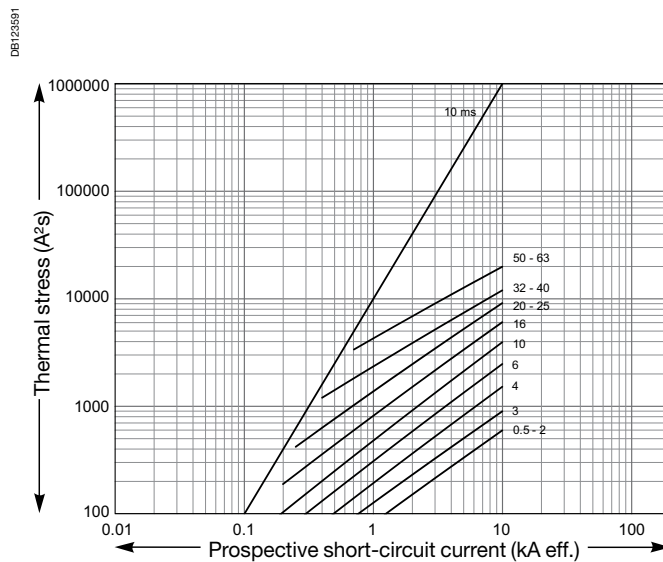

C60H-DC curve C

1P (250 V DC) - 2P (500 V DC)

Peak current

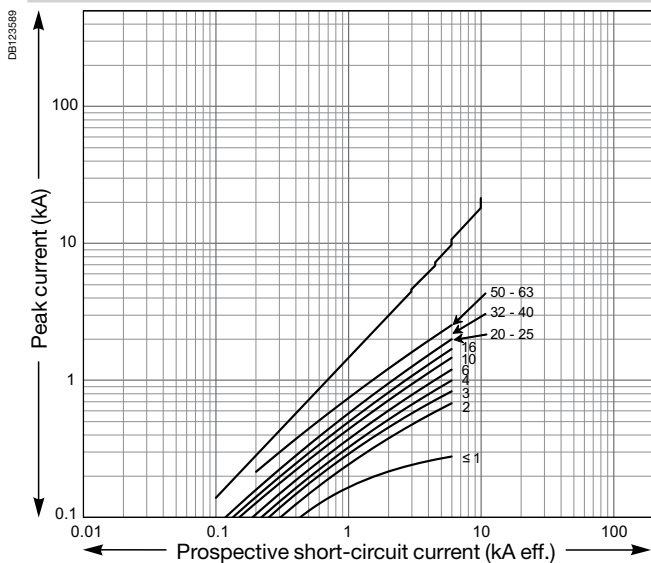

Thermal stress

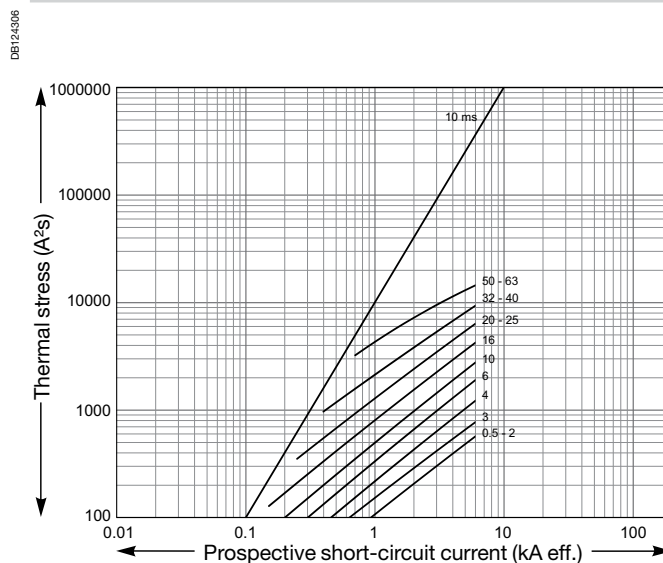

Circuit breakers for direct current applications

24 V - 48 V direct current applications

Typical applications

Direct current has been used for a long time and in many fields. It offers major advantages, in particular immunity to electrical interference. Moreover, direct-current installations are now simpler, because they benefit from the development of power supplies with electronic converters and batteries.

- Communication or measurement network:
 - 48 V DC switched telephone network,
 - 4-20 mA current loop.
- Electrical supply for industrial PLCs:
 - PLCs and peripheral devices (24 or 48 V DC).
- Auxiliary uninterruptible direct current power supply:
 - relays or electronic protection units for MV cubicles,
 - switchgear opening / closing trip units,
 - LV control and monitoring relays,
 - indicator lights,
 - circuit-breaker or on/off switch motor drives,
 - power contactor coils,
 - control/monitoring and supervision devices with communication that can be powered via a separate uninterruptible power supply.
- 24 to 48 V DC wind application:
 - isolated homes,
 - cottages, bungalows, mountain refuges,
 - pumps, street lighting,
 - measuring instruments, data acquisition,
 - telecommunication relays,
 - industrial applications.

Types of direct current networks

According to the types of DC networks illustrated below, we can identify the risks to the installation and define the best means of protection.

Earthed		Isolated from earth	
I: Earthed (or grounded) polarity (in this case negative)		II: Earthed mid-point	III: Isolated polarities
1 pole (1P isolation)	2 poles (2P isolation)	2 poles	2 poles
<p>DB124075</p>	<p>DB124067</p>	<p>DB124076</p>	<p>DB124068</p>
	<p>DB124387</p>		
Worst-case faults			
Fault A and fault B (if only one polarity is protected)		Fault B	Double fault A and D or C and E

11

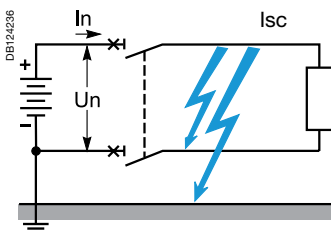

For further information on the types of networks and the faults that characterise them, refer to the direct current circuit breaker (LV) selection guide, 220E2100.indd.

For all these configurations, we propose a single protection solution that depends only on the requirement for the nominal current I_n and the short-circuit current I_{sc} at the installation point concerned.

The second important point in our solution is the fact that the protection is implemented by non-polarised circuit breakers that can operate efficiently, whatever the direction of the direct current.

Circuit breakers for direct current applications (cont.)

24 V - 48 V direct current applications

24 - 48 V direct current protection solution

The performance levels shown in the tables below correspond to the most critical faults according to the network configuration.

- Breaking on one pole.
- Fault between polarity and earth (Fault A).

Standard solution depending on the network and the requirements of the installation (In / Isc)

In addition to the parameters shown on the following pages, the tables below illustrate our range of circuit breakers according to the nominal current of the load and short-circuit current at the point of installation.

- Circuit breaker rating.
- Breaking capacity of the circuit breaker.

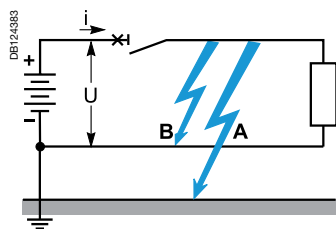

1 pole isolation solution (1P)

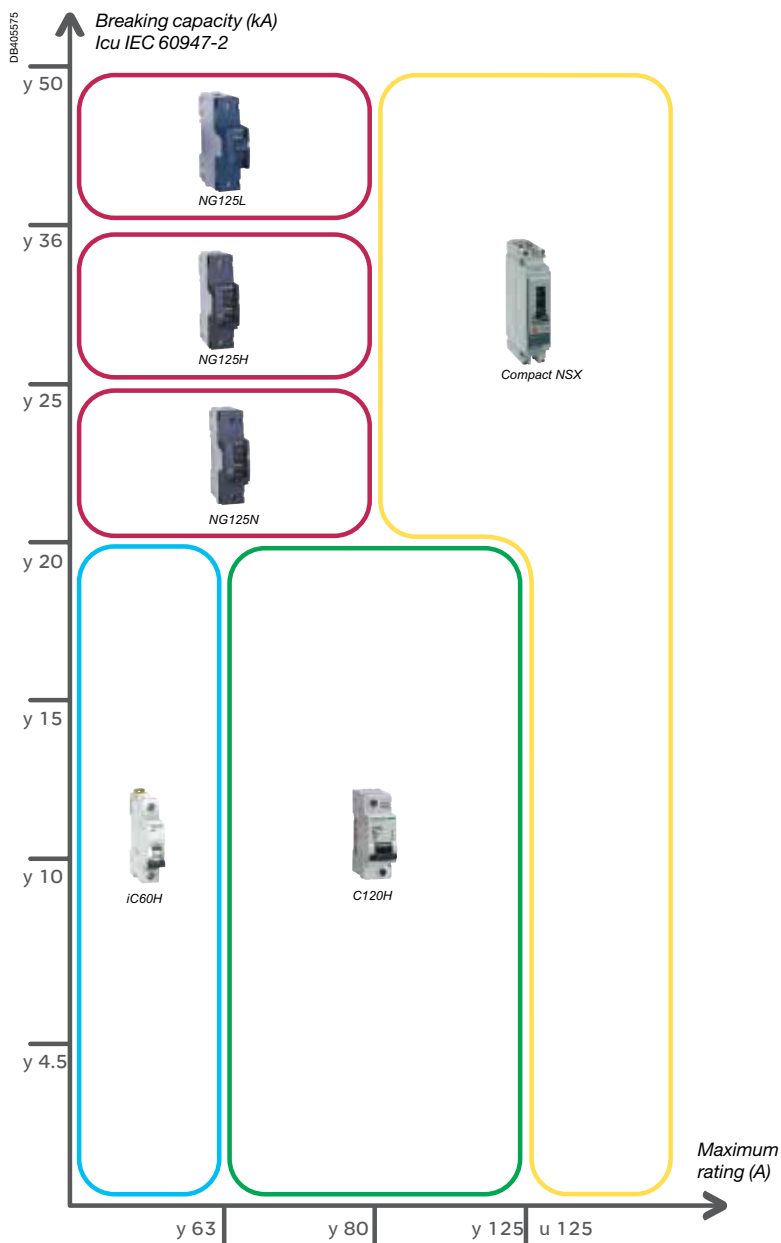

Circuit breakers for direct current applications (cont.)

24 V - 48 V direct current applications

2 poles isolation solution (2P)

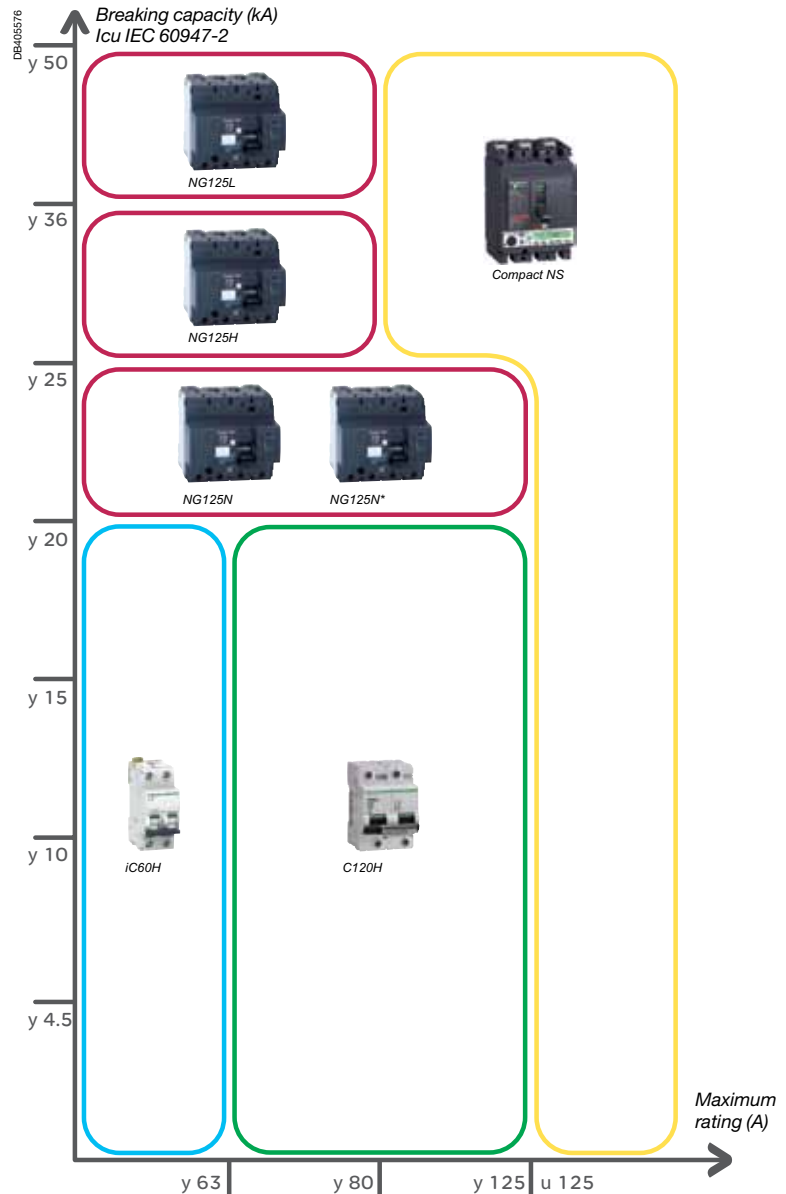
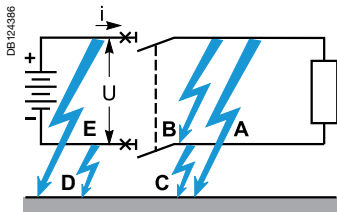
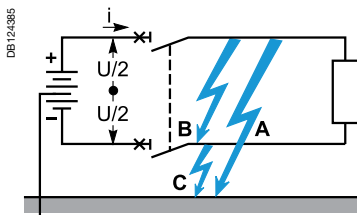
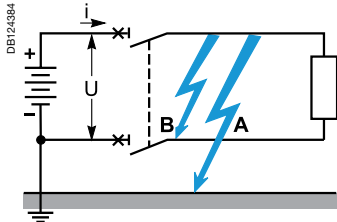

(*) 3P NG125N connected in a two-pole configuration to reach 125 A (1P / 2P NG125 has a maximum rating of 80 A).

1 pole isolation solution (1P+N)

Specific use of the iDPN range in a network with one polarity earthed and both poles isolated: compact solution (1P+N in 18 mm).

Breaking capacity (kA)
Icu IEC 60947-2

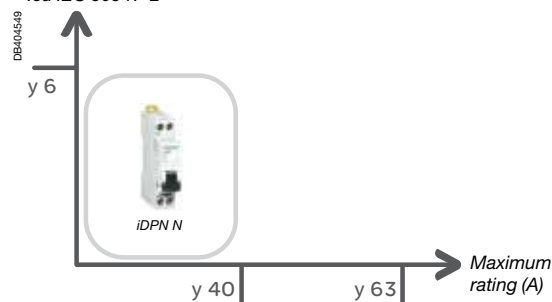
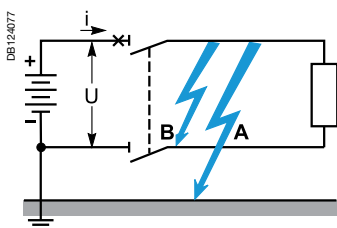

(*) iC60a breaking capacity Icu = 10 kA.

Constraints related to "direct current" applications

In direct current, inductors and capacitors do not disturb the operation of the installation in steady state. Capacitors are charged and inductors no longer oppose changes in the current.

However, they create transient phenomena when the circuit opens or closes, during which time the current varies. Actual loads have both characteristics and generate oscillatory phenomena.

Type of load

Inductive load

An inductive load will tend to lengthen the current interrupt or establishment time, because the inductance L then opposes the change in the current ($L di/dt$).

The transient phenomenon will mainly be characterised by a time constant imposed by the load and whose value corresponds approximately to the interrupt or closing time that the switchgear has to withstand. In addition, during the interrupt time, the switchgear must be able to withstand the additional energy stored in the inductor in steady state.

An inductive load therefore requires particular attention with respect to its time constant.

A low value (typically < 5 ms) facilitates interruption.

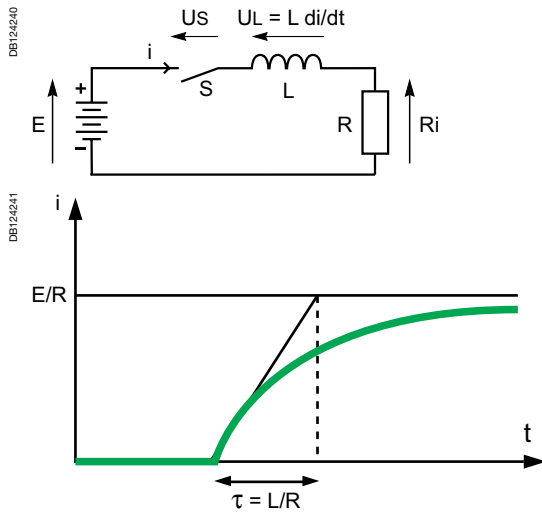

Inductive load

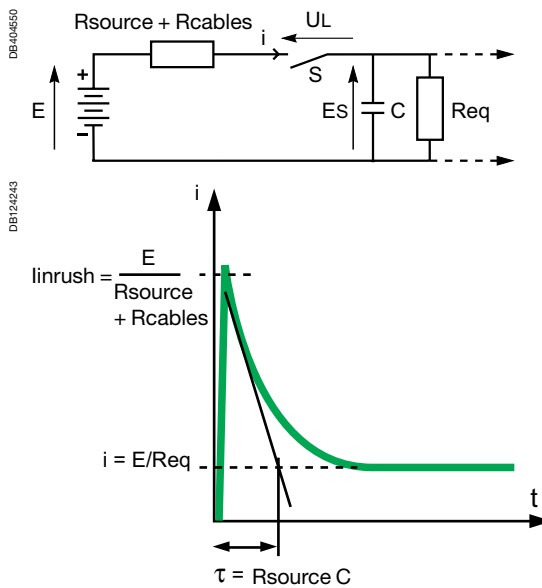

Capacitive load

Capacitive load

During a closing operation, a capacitive load will cause an inrush current due to the load on the capacitor, virtually under short-circuit condition at the beginning of the phenomenon.

On opening, it will tend to discharge. The time constant is generally very low (< 1 ms) and its effect is secondary with respect to the inrush current. A capacitive load will require particular attention to the inrush or discharge current surges.

Circuit breakers for direct current applications (cont.)

24 V - 48 V direct current applications

Time constant L/R

When a short-circuit occurs across the terminals of a direct current circuit, the current increases from the operating current ($< I_n$) to the short-circuit current I_{sc} during a time depending on the resistance R and the inductance L of the short-circuited loop.

The equation that governs the current in this loop is: $U = Ri + Ldi/dt$.

A short-circuit current is established (neglecting I_n with respect to I_{sc}) by the equation:

$$i = I_{sc} (1 - \exp(-t/\tau)),$$

where $\tau = L/R$ is the time constant used to establish the short-circuit.

In practice, after a time $t = 3\tau$ the short-circuit is considered to be established, because the value of $\exp(-3) = 0.05$ is negligible compared to 1. The lower the corresponding time constant (e.g. battery circuit), the faster a short-circuit is established.

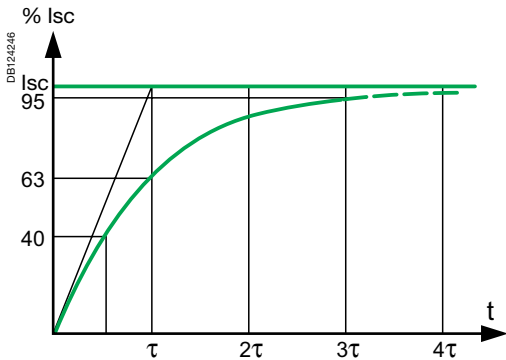
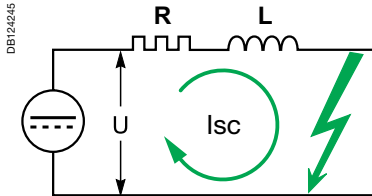

L/R	Description	DC applications
2 ms	Very fast short-circuit	<ul style="list-style-type: none"> ■ Photovoltaic applications
5 ms	Fast short-circuit established	<ul style="list-style-type: none"> ■ Resistive or slightly inductive circuits: <ul style="list-style-type: none"> <input type="checkbox"/> indicator light <input type="checkbox"/> trip units (MN, MX) <input type="checkbox"/> motor armatures <input type="checkbox"/> battery charger/uninterruptible power supply (UPS) ■ Capacitive circuits: electronic controller
15 ms	Standardised value used in standard IEC 60947-2	<ul style="list-style-type: none"> ■ Inductive circuits: <ul style="list-style-type: none"> <input type="checkbox"/> electromagnetic coil <input type="checkbox"/> contactor coil <input type="checkbox"/> motor inductor
30 ms	Slower short-circuit established	<ul style="list-style-type: none"> ■ Highly inductive circuits: <ul style="list-style-type: none"> <input type="checkbox"/> electromagnetic coil <input type="checkbox"/> contactor coil <input type="checkbox"/> motor inductor

In general, the system time constant is calculated under worst case conditions, across the terminals of the generator.

Circuit breakers for direct current applications (cont.)

24 V - 48 V direct current applications

Tripping curves

We can choose our solution according to the inrush currents generated by our loads, in the same way as for alternating current. In direct current, the same thermal tripping curves are obtained as in alternating current. The only difference is that the magnetic thresholds are offset by a coefficient $\sqrt{2}$ compared to the curves obtained in alternating current.

Characteristics of the various curves and their applications:

Curves	Magnetic thresholds		DC applications
	AC	DC	
Z	2.4 to 3.6 In	3.4 to 5 In	<ul style="list-style-type: none"> Resistive loads Loads with electronic circuits
B	3.2 to 4.8 In	4.5 to 6.8 In	<ul style="list-style-type: none"> Motor inductor: starting current 2 to 4 In Battery charger/Uninterruptible power supply (UPS)
C	6.4 to 9.6 In	9.05 to 13.6 In	<ul style="list-style-type: none"> Electronic controller
D et K	9.6 to 14.4 In	13.6 to 20.4 In	<ul style="list-style-type: none"> Electromagnetic coil: inrush overvoltage 10 to 20 Un LV relay Trip units (MN, MX) Indicator light PLCs (industrial programmable logic controllers)

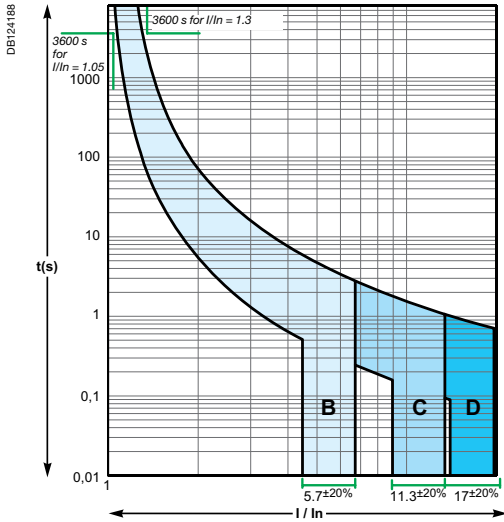

Curves B, C, D, ratings 6 A to 63 A

The figures opposite are iC60 tripping curves showing DC magnetic thresholds and normative limits

Example

Protection of the 4 mm² cable supplying a load at In = 30 A with a 32 A rating and a tripping curve that allows the starting current for this load to be absorbed.

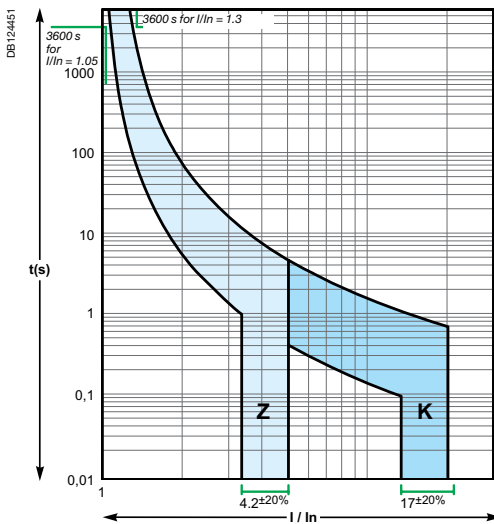

Curves Z, K, ratings 6 A to 63 A

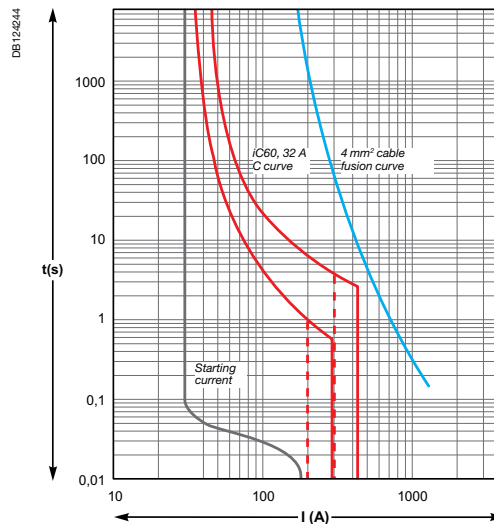

Curve C, rating 32 A (AC magnetic thresholds in dotted lines)

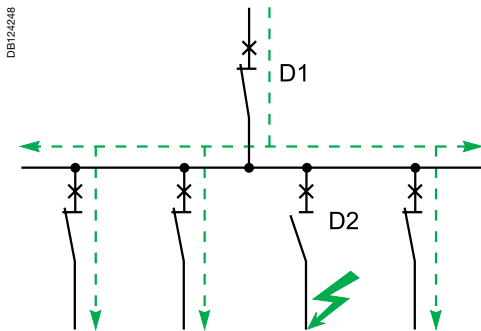
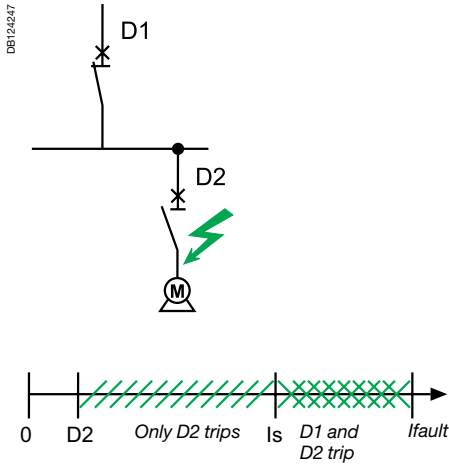

Continuity of service of the solutions

Discrimination of the direct current protection devices

Discrimination is a key element that must be taken into account right from the design stage of a low-voltage installation to allow continuity of service of the electrical power.

Discrimination involves coordination between two circuit breakers connected in series, so that in the event of a fault, only the circuit breaker positioned immediately upstream of the fault trips. A discrimination current I_s is defined as:

- $I_{\text{fault}} < I_s$: only D2 removes the fault, discrimination ensured,
- $I_{\text{fault}} > I_s$: both circuit breakers may trip, discrimination not ensured.

Discrimination may be partial or total, up to the breaking capacity of the downstream circuit breaker. To ensure total discrimination, the characteristics of the upstream device must be higher than those of the downstream one.

The same principles apply to designing both direct current and alternating current installations. Only the limit currents change when direct current is used.

Once again, we find the same concepts of discrimination:

- **total**: up to the breaking capacity of the downstream device. Our tests have been performed at up to 25 kA or 50 kA depending on the breaking capacity of the devices in question.
- **partial**: indication of the discrimination limit current I_s . Discrimination is ensured below this value; above this value, the upstream device participates in the breaking process,
- **none**: no discrimination ensured, the upstream and downstream circuit breakers will trip.

For further information about the discrimination concept for protection devices in general, refer to technical supplement 557E4300, "Discrimination of modular circuit breakers".

Total discrimination solutions

In the following tables, we offer you solutions that favour continuity of service (total discrimination between circuit breakers), for different short-circuit currents.

Total discrimination: 20 kA

		Upstream		Curve C		Time constant (L/R) = 15 ms				
In (A)		iC60H				iC120H		NS		
		10 - 16	20 - 25	32	40	50 - 63	80	100	125	≥ 100
Downstream										
iC60H	≤ 3	T	T	T	T	T	T	T	T	T
Curves B,C	4		T	T	T	T	T	T	T	T
	6				T	T	T	T	T	T
	10						T	T	T	T
	13						T	T	T	T
	16 to 25						T	T	T	T
	32							T	T	T
	40								T	T
	50 - 63								T	T

Total discrimination: 36 kA

		Upstream		Curve C		Time constant (L/R) = 15 ms				
In (A)		NG125H		NS						
		80		≥ 100						
Downstream										
NG125H	10	T			T					
Curves B,C	16 to 63				T					

Total discrimination: 50 kA

		Upstream		Curve C		Time constant (L/R) = 15 ms				
In (A)		NG125L		NS						
		80		≥ 100						
Downstream										
NG125L	10	T			T					
Curves B,C	16 to 63				T					

Total discrimination.
 No discrimination.

Circuit breakers for direct current applications (cont.)

24 V - 48 V direct current applications

Coordination with loads

As seen above, the circuit-breaker characteristics chosen depend on the type of load downstream of the installation.

The rating depends on the size of the cables to be protected and the curves depend on the load inrush current.

Product selection according to the load inrush current

When certain "capacitive" loads are switched on, very high inrush currents appear during the first milliseconds of operation. The following graphs show the average DC non-tripping curves of our products for this time range (50 μ s to 10 ms).

iC60

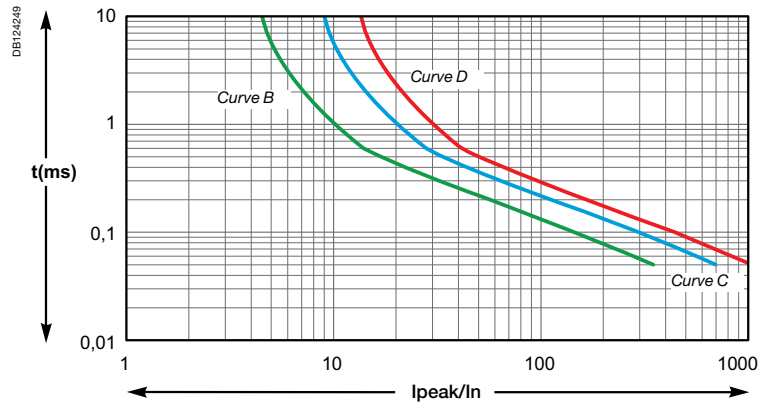

NG125 / C120

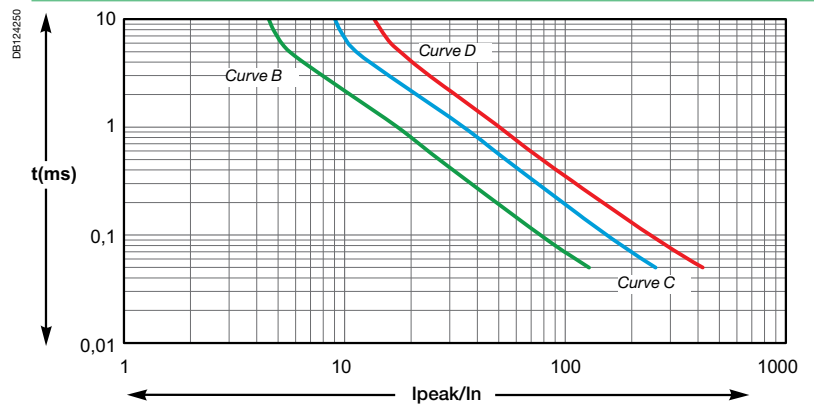

This information allows us to select the most appropriate product, according to the load specifications: curve and rating.

Example

When an iC60 is used with a load with current peaks in the order of 200 I_n during the first 0.1 millisecond, a curve C or D product must be installed.

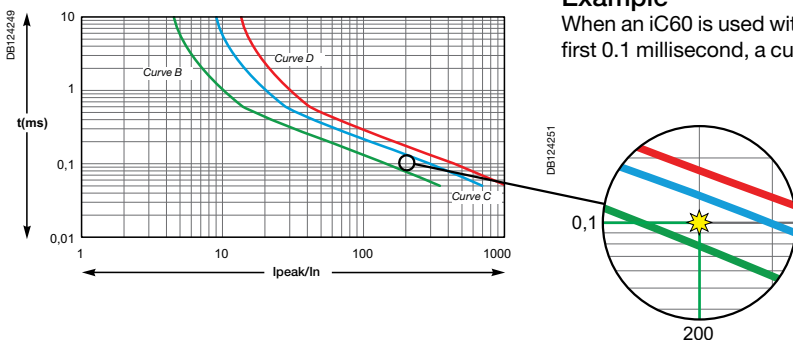

Circuit breakers for direct current applications (cont.)

24 V - 48 V direct current applications

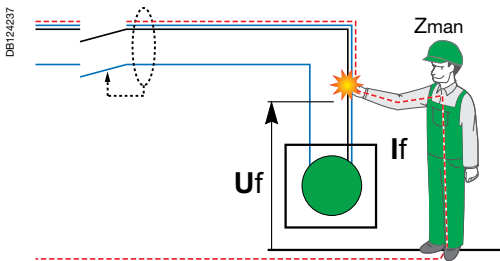
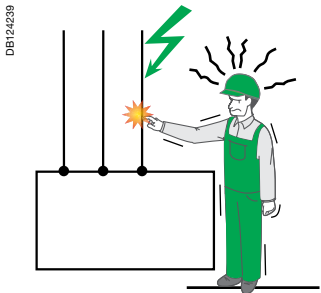
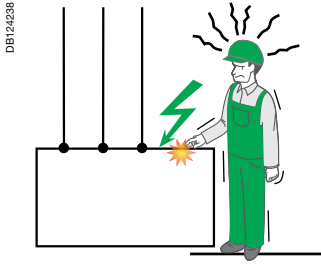

Standards: IEC 60479-2, NF C 15100, IEC 60755.

Personal protection

Personal protection (earth-leakage protection) is not mandatory for this voltage range (24-48 V DC).

In fact, according to the standards currently in force, the minimum ventricular fibrillation current I_f for human beings is in the order of 25 mA for alternating current (50 Hz), whereas for direct current, it is more than 50 mA.

The table below shows the data according to the standards and conditions:

Environment		Voltage specifications	
		AC	DC
Dry environment	$U_f = Z \times I_f$	50 V	100 V
Z _{man} = 2000 Ohm			
Wet environment	$U_f = Z \times I_f$	25 V	50 V
Z _{man} = 1000 Ohm			

With Z corresponding to the impedance of the human body in the different types of environment, I_f being the current passing through the body and U_f the minimum contact voltage required to reach the danger current.

Under normal operating conditions, this voltage range (< 50 V) is therefore not dangerous to human beings.

Examples of applications

Industrial applications

Monitoring of agro-food tanks with 24 V DC converters for probes and other sensors

- Isolated network:
- $I_{sc} = 20 \text{ kA}$,
- $I_n = 40 \text{ A}$.

Solution

iC60H 2P 40 A + 24 V converters

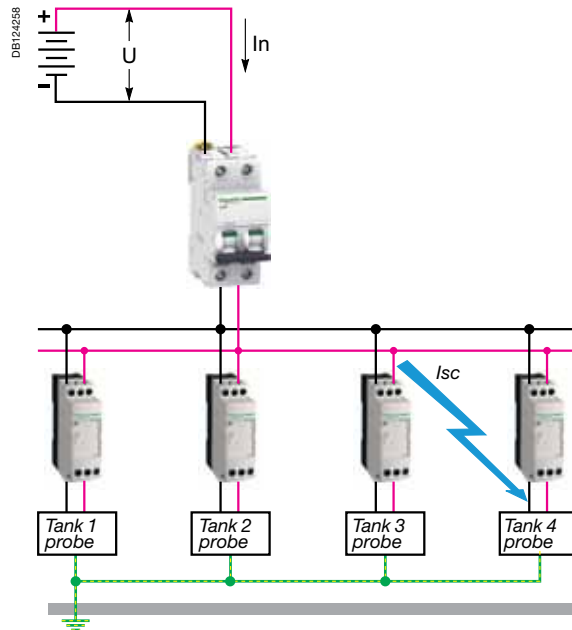

Control of industrial process measurement by 12/24/48 V DC control

- Isolated network:
- $I_{sc} = 20 \text{ kA}$,
- $I_n = 40 \text{ A}$.

Solution

iC60H 2P 40 A + DC solid-state relays

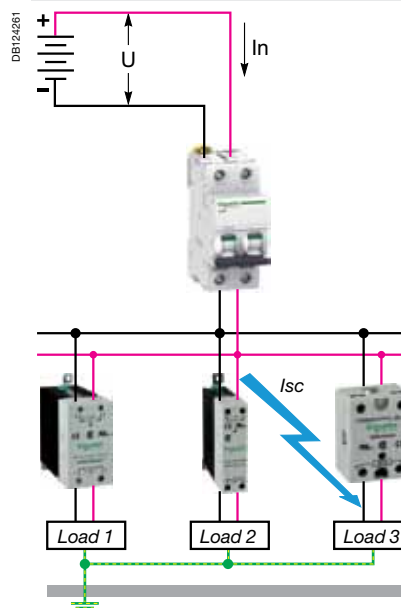

Circuit breakers for direct current applications (cont.)

24 V - 48 V direct current applications

24 V DC generator power supply protection

- Earthed network:
- $I_{sc} = 10 \text{ kA} / I_n = 63 \text{ A}$,
- $I_{sc} = 10 \text{ kA} / I_n = 20 \text{ A}$.

Solution

iC60H 2P 63 A + iC60N 2P 20 A + DC loads

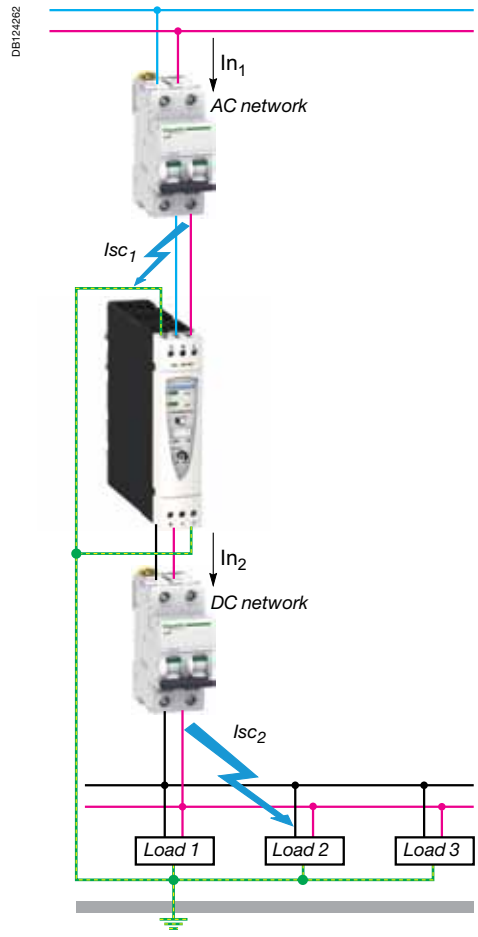

Circuit breakers for direct current applications (cont.)

24 V - 48 V direct current applications

Tertiary applications

Control and monitoring of the 48 V DC emergency lighting distribution for a shopping centre

- Mid-point of the network:
- $I_{sc} = 20 \text{ kA}$,
- $I_n = 125 \text{ A}$.

Solution

NG125H 3P 125 A + power contactors

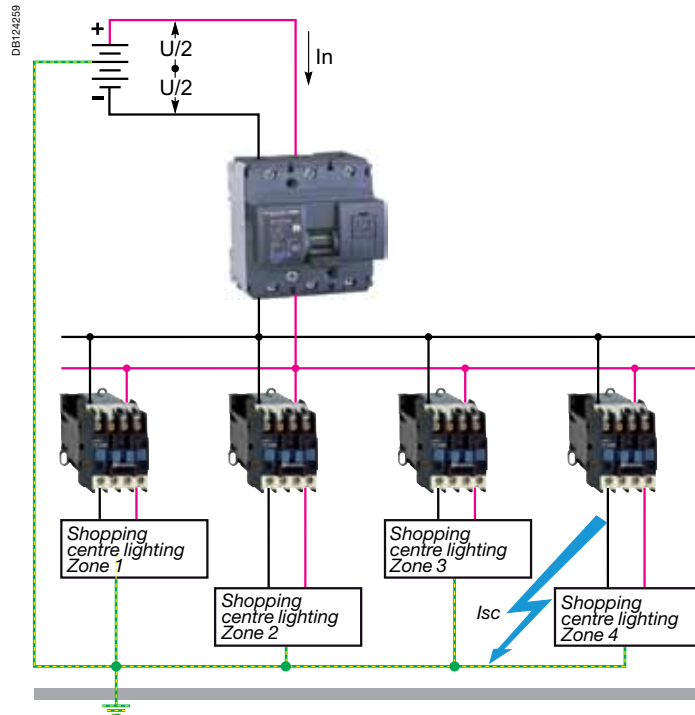

Circuit breakers for direct current applications (cont.)

24 V - 48 V direct current applications

Power supply protection by 24 V DC direct current generator

- Earthed network:
- $I_{sc1} = 10 \text{ kA} / I_n = 40 \text{ A}$,
- $I_{sc2} = 10 \text{ kA} / I_n = 2/4/6 \text{ A}$.

Solution

iC60H 2P 40 A + iC60H 2P 2/4/6 A + PLC inputs + DC loads

The Phaseo network failure solution provides the installation (or part thereof) with a 24 V DC power supply in the event of a mains voltage failure:

- throughout the mains failure, to ensure the continuity of service of the installation.
- during a limited time to allow:
 - data to be backed up,
 - actuators to be put in the fallback position,
 - a generating set to be started up,
 - the operating systems to be shut down,
 - remote supervision data to be transmitted.

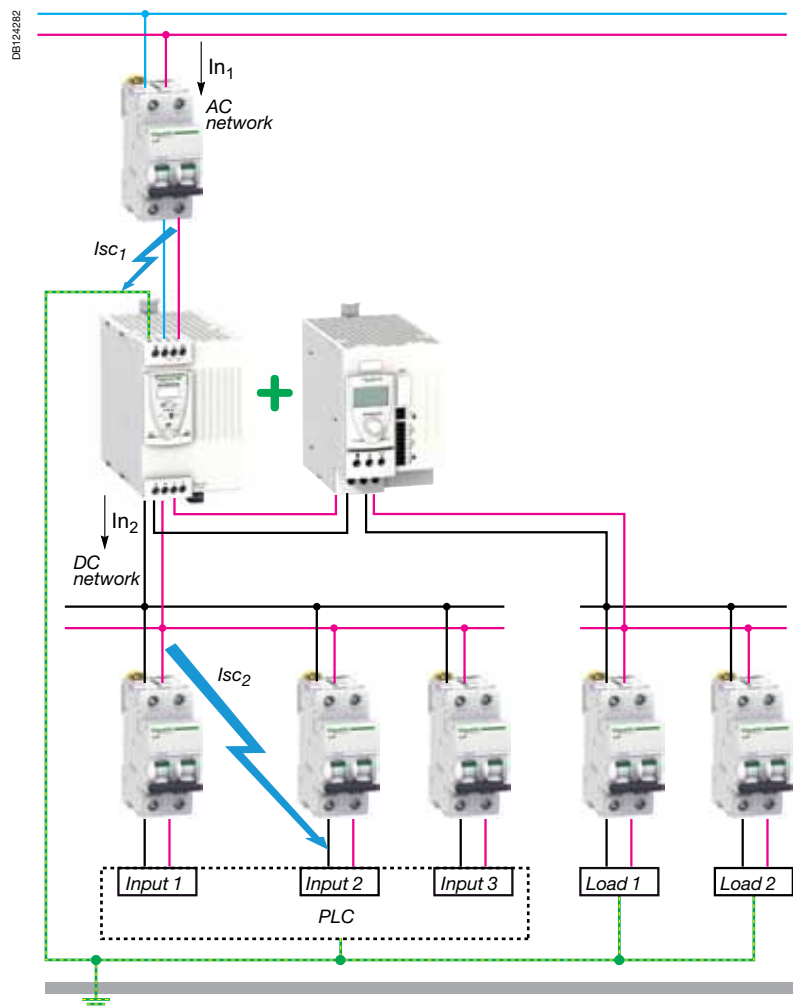

Compatibility of 50/60 Hz equipment with a 400 Hz network

The performance of products designed for domestic frequencies of 50/60 Hz is impacted by the specific properties of networks of 400 Hz frequency.

Phenomena due to the increased frequency influence the behaviour of the copper components of transformers, cables and protective equipment.

Some types of equipment designed for 50/60 Hz networks may not be suitable. You should check whether or not a product is compatible and also apply any correction factors given by the manufacturer.

Circuit breakers

Depending on the technologies used, modular circuit breakers designed for 50/60 Hz can be used at 400 Hz.

To choose the performance of a modular circuit breaker:

- do not take any thermal derating into account (In at 400 Hz is equivalent to In at 50 Hz).
- increase the magnetic tripping threshold, according to the table below.
- check that the short-circuit current on the installation is less than the breaking capacity of the circuit breaker. The breaking capacity of the circuit breakers at a frequency of 400 Hz is the same as at frequencies of 50/60 Hz. This characteristic is generally complied with, due to the fact that the short-circuit current of a 400 Hz generator is relatively low. In most cases, the generator I_{sc} does not exceed four times the rated current.

Circuit breaker	Curve	Magnetic trip thresholds		Tolerance
		50 Hz	400 Hz	
iDPN	B	4 In	6 In	± 20 %
	C	8 In	12 In	
	D	12 In	18 In	
iC60	B	4 In	5.6 In	
	C	8 In	11.2 In	
	D	12 In	16.8 In	
C60	B	4 In	5.1 In	
	C	8.5 In	10.9 In	
	D	12 In	15.4 In	
C120	The NG125 and C120 circuit breakers are not suitable for networks of 400 Hz frequency. Refer to the Compact NSX offer.			
NG125				

Earth leakage protection devices

The residual current device trip thresholds designed for 50/60 Hz increase with the frequency, but since the human body is less sensitive to the passage of a current at 400 Hz, protection is still ensured for the users.

According to the IEC 60479-2 standard, at 400 Hz the ventricular fibrillation threshold is higher by a ratio of 6 (which means that the physiological effect of a 180 mA current at 400 Hz will be the same as that of a 30 mA current at 50/60 Hz).

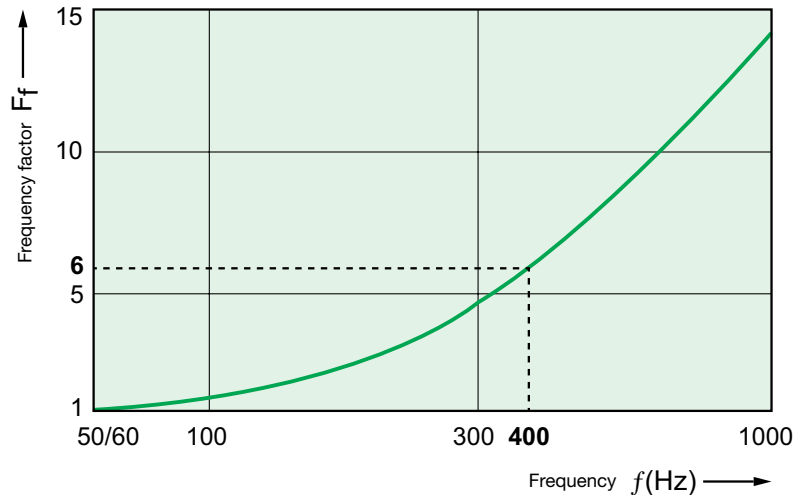

Variations in the ventricular fibrillation threshold for shock durations exceeding the period of cardiac cycle (as per IEC 60479-2).

Compatibility of residual current devices at 400 Hz:

Depending on the type and the technology employed, a residual current device designed for a frequency of 50/60 Hz will or will not be capable of ensuring protection for users in accordance with the requirements of the standard.

Type of protection and type of equipment	Use possible on network of 400 Hz frequency	Limit
A type	Not compatible	Trip threshold exceeding the limit given by the curve
AC type	Not recommended	Excessive sensitivity with risk of unwanted tripping (poor guarantee of continuity of service)
Si type	iID	YES
	Vigi iC60	Not compatible
	iDPN Vigi,	YES

Note: The choice of an iID residual current circuit breaker ensures protection for users at 400 Hz while ensuring good continuity of service.

At 400 Hz, the test function of residual current devices designed for 50/60 Hz is not operational due to the increase in the trip threshold.

Auxiliary function

Voltmetric releases

If a circuit breaker needs to be provided with a voltmetric release whose control circuit is powered by the 400 Hz network, it is necessary to use a release auxiliary of appropriate characteristics for 400 Hz networks:

Type	Voltage	Cat. no.
Undervoltage release iMN	115 V AC - 400 Hz	A9A26959

Motor starters

In general miniature circuit breakers can give only short circuit protection to motor loads due to the high starting currents which may be encountered; typically 3 - 12 times full load current (FLC).

Assumptions

The tables give recommended MCB ratings for motors up to 37kW based on the following assumptions:

■ Direct-on-line starting

- Starting current = 7 x FLC
- Run up time = 6seconds, motors <3kW
- 10 seconds, motors < 22kW
- Running currents = average values only (individual manufacturer's figures will vary), four pole motors, i.e. speed approx. 1500rpm

For higher inertia loads, i.e. hoists or fans, run up times may be considerably longer than those assumed above. The rating of the MCB must take account of the greater run up time and starting current. The required MCB rating can be determined by reference to time/current curves (consult us).

■ Star/delta starting

Since, during the changeover from star to delta, a high current surge in the order of DOL values may be met, the MCB rating selected should be the same as that recommended for DOL starting.

Table 1 - 3 phase 415Vac D.O.L. starting

kW	hHp	Running I	Recommended MCB		
			C60HB	C60HC	C60HD
0.12	0.166	0.65	2	2	1
0.18	0.25	0.7	2	2	1
0.25	0.33	0.87	4	2	1
0.37	0.5	1.35	4	4	2
0.55	0.75	1.55	4	4	2
0.75	1.0	1.93	6	4	4
1.1	1.5	2.5	6	6	4
1.5	2	3.5	10	10	6
2.2	3	4.8	16	10	10
3	4	6.4	20	20	10
3.75	5	7.8	25	25	16
4	5.5	8.1	25	25	16
5.5	7.5	11	32	32	16
7.5	10	14.4	50	50	20
9.33	12.5	17.3	63	50	20
11	15	21	63	63	25
13	17.5	25	-	-	32
15	20	28	-	-	40
18.5	25	35	-	-	50
22	30	40	-	-	50
30	40	54	-	-	63
37	50	65.5	-	-	-

Table 2 - 1 phase 240Vac D.O.L. starting

kW	Hp	Running I	C60HB	C60HC	C60HD
0.12	0.166	0.95	4	2	1
0.18	0.25	1.5	4	4	2
0.25	0.33	1.7	6	4	2
0.37	0.5	3	10	6	4
0.55	0.75	4.5	16	10	6
0.75	1	5.5	16	16	10
1.1	1.5	8.5	25	25	16
1.5	2	10.5	32	32	20
2.2	3	15.5	40	40	25
3	4	20	63	63	32
3.75	5	24	-	63	40
5.5	7.5	34	-	-	50
6.3	8.5	36.5	-	-	63
7.5	10	45	-	-	63
11	15	66.5	-	-	-

Transformers

High inrush currents are also produced when transformers are switched on, typically 10 - 15 times full load current.

Assumptions

The tables give recommended MCB ratings for single phase transformers up to 12500VA and three phase transformers up to 30000VA based on the following formula.

Table 3 - 3 phase transformers 415Vac supply				
VA	Primary In (A)	C60HB	C60HC	C60HD
500	0.7	4	2	1
750	1.04	6	4	2
1000	1.39	10	6	4
2000	2.78	16	10	6
5000	6.95	40	25	16
10000	13.89	-	50	25
15000	20.84	-	63	32
20000	27.78	-	-	50
25000	34.73	-	-	63
30000	41.67	-	-	63

Table 4 - 1 phase transformers 240Vac supply				
VA	Primary In (A)	C60HB	C60HC	C60HD
50	0.21	2	-	-
100	0.42	4	2	1
250	1.04	6	4	2
500	2.08	16	10	4
1000	4.17	25	16	10
2500	10.42	63	32	16
5000	20.84	-	63	32
10000	41.66	-	-	63
12500	52.08	-	-	-

Inrush currents

When LV/LV transformers are switched on, very high inrush currents are produced which must be taken into account when choosing overcurrent protection devices. The peak value of the first current wave often reaches 10 - 15 times the rated rms current of the transformer and may reach values of 20 - 25 times the rated current even for transformers rated less than 50kVA. This transient inrush current decays very quickly (in a few milliseconds).

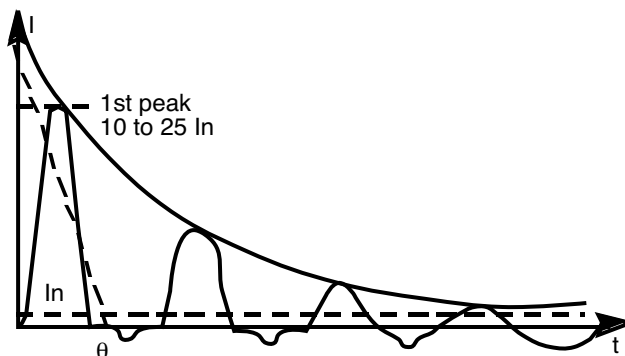

Choice of motor supply cable size

When selecting the cable size the starting current of the motor and the permissible voltage drop must be taken into account. The cable must be capable of carrying a permanent service current at least equal to the sum of $I_n + I_s/3$ where:

I_n = rated current

I_s = starting current (4 - 8 I_n) depending on the motor.

Voltage drop

The permissible voltage drop from the start of the installation to the motor in question is 6% for public distribution systems. If the torque of the machine to be driven is low during starting it is only necessary to check the voltage drop for the rated current of the motor. If the starting torque is high (grinding mills, goods lifts, etc.) the voltage drop should be checked for the starting current.

P25M motor circuit breaker

This protects motors against overloads and short circuits. P25M type circuit breaker has on each pole a thermal release for protection against overloads and a magnetic release for protection against short circuits. For high short circuit currents use the limiter block, Ref. 21115. For ratings from 0.16A - 10A, 415V or from 0.16 - 18A, 240V; in this case the breaking capacity of the P25M circuit breaker is unlimited.

Applications

The P25M circuit breaker is particularly suitable for protecting **small machine tools** and similar machines, with **local control**.

Thermal release settings

The thermal releases are supplied set to the bottom value of the setting range. Simultaneous setting of the thermal releases can be carried out by opening the cover and adjusting the dial on the front face of the P25M. It is recommended that the thermal releases be set to the current that the motor absorbs in normal service and not to its rated current so as to provide effective close protection.

Ambient temperature compensation

Close protection against thermal overload is enhanced by thermal releases which are ambient temperature compensated over the range - 20°C - +60°C. During overload conditions, tripping is delayed at lower ambient temperatures, from - 20°C - +20°C, and is accelerated at higher ambient temperatures, from 20°C - +60°C.

Protection of the line supplying the motor

Every circuit and every motor must be protected against overloads and short circuits.

Phase failure protection

The P25M protects each phase separately and interrupts all three phases in the event of a loss of phase. Single phasing sensitivity is achieved by means of a differential trip which accelerates tripping should phase failure occur.

Auxiliaries:

- Alarm switch.
- ON/OFF switch.
- Shunt trip release or undervoltage release (emergency stop).

Single phase connection

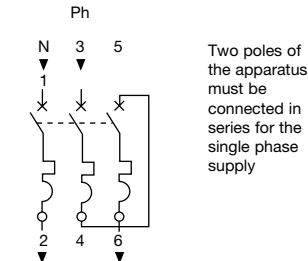

Emergency switch wiring

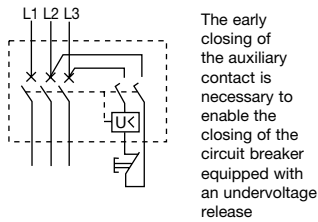

Time/current characteristics

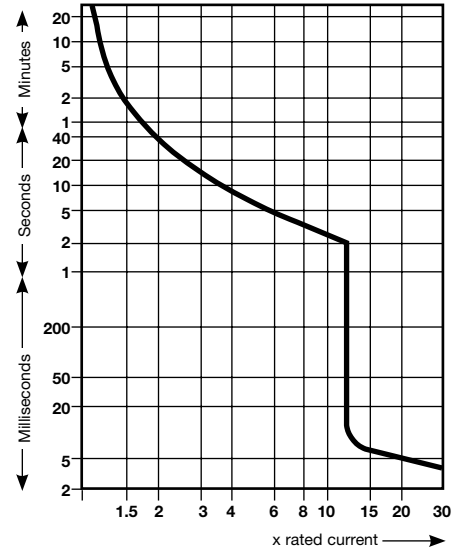

Rating In (A)	Settings	Part number	Standard power ratings kW: of 3-phase motors 50 - 60Hz AC-3 category					
			230	400	415	440	500	690
0.16	0.1 - 0.16	21100	-	-	-	-	-	-
0.25	0.16 - 0.25	21101	-	-	-	-	-	-
0.40	0.25 - 0.40	21102	-	-	-	-	-	-
0.63	0.40 - 0.63	21103	-	-	-	-	-	0.37
1.0	0.63 - 1	21104	-	-	-	0.37	0.37	0.55
1.6	1 - 1.6	21105	-	0.37	-	0.55	0.75	1.1
2.5	1.6 - 2.5	21106	0.37	0.75	1.1	1.1	1.1	1.5
4.0	2.5 - 4	21107	0.75	1.5	1.5	1.5	2.2	3
6.3	4 - 6.3	21108	1.1	2.2	2.2	3	3.7	4
10	6 - 10	21109	2.2	4	4	4	5.5	7.5
14	9 - 14	21110	3	5.5	5.5	7.5	9	11
18	13 - 18	21111	4	7.5	9	9	10	15
23	17 - 23	21112	5.5	9	11	11	11	18.5
25	20 - 25	21113	5.5	11	11	11	15	22

Discrimination

The table below indicates where total discrimination exists between devices.

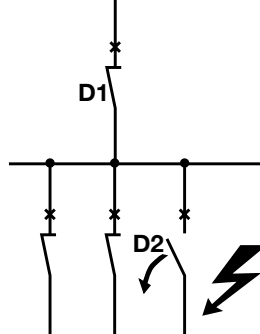

Upstream Compact			MGE1003X	MGE1253X	MGE1603X	MGE2003X	MGE2503X	MGE4003X	MGE6303X
Downstream circuit breaker	Rating (A)								
multi 9	iC60H	10 - 16	■	■	■	■	■	■	■
		20 - 25		■	■	■	■	■	■
		32 - 40		■	■	■	■	■	■
		50 - 63		■	■	■	■	■	■

Note: For further information on this product range: consult us.

Guidance for motor loads

Specific “magnetic only” MCCBs are available for short circuit protection of motors. However, the standard MCCB may be used, as detailed below.

	Max motor size (kW)	Running current (A) @ 415V
16A	2.2	5.0
25A	3.7	7.5
40A	4	8.4
63A	9	17
80A	15	28
100A	22	40
125A	25	47
160A	33	60
200A	45	80
250A	69	128

Note:

- These tables offer guidance only, for DOL starting assuming:
 - A starting current of 7 x FLC
 - Run-up time =8 seconds for motors
 - < 3kW
 - 10 seconds for motors
 - > 3kW
- The running current is a typical value and may vary from manufacturer to manufacturer

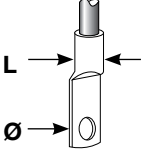

Current	Device		Possible terminal capacity for crimped lug		Breaking capacity 415V
			(mm) Ø	@ L	
100A	MGP100	MCCB SP	6	25	25,000A @ 240V
100A	MGP100X	MCCB TP	6	25	36,000A
160A	MGP160X	MCCB TP	6	25	36,000A
250A	MGP250X	MCCB	8	25	36,000A
	MGP250NA	Switch disconnect	8	25	-
400A	MGP400X	MCCB	10	32	50,000A
	MGP400A	Switch disconnect	10	32	-
630A	MGP630X	MCCB	10	32	50,000A
	MGP630NA	Switch disconnect	10	32	-
800A	NS800		12	44	50,000A
	NS800NA	Switch disconnect	12	44	-
	MGP INC	Direct connection	10	32	-
	Outgoing	Earth connection	6	25mm tunnel	-
	Outgoing	Neutral connection	6	25	-
	Incoming	Earth connection	10	32	-
	Incoming	Neutral connection	12	40	-

Other connections available on request. If you require higher breaking capacity, consult us.

1600A Panelboard

Incoming connection details
 4 - Ø12.5 holes on 50 mm pitch
 Pole pitch = 70mm
 Distance to gland plate = 708mm

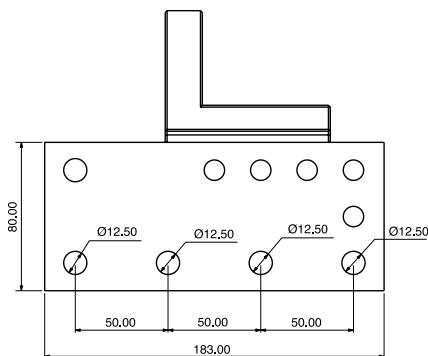

External influences

In many national and international standards, a large number of external influences to which an electrical installation can be subjected are indexed and coded: presence of water, presence of solid objects, risk of impact, vibrations, presence of corrosive substances, etc. These influences may be present with variable intensity depending on the conditions of installation: The presence of water may be in the form of a few drops or total immersion.

Protection index





European standard EN60529 gives a protection code (IP) which characterises the ability of equipment to withstand the following external influences:

- Presence of solid bodies
- Presence of water



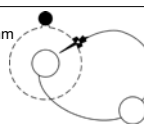
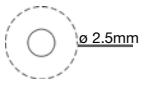
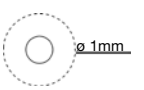

This code comprises two digits, depending on these external influences. The protection index is assigned to the equipment following a series of tests laid down in the respective standards.

Test according to EN60529

1st digit Protection against solid bodies

0		No protection Protection against solid bodies greater than 50 mm
1		Protection against solid bodies greater than 50 mm
2		Protection against solid bodies greater than 12.5mm
3		Protection against solid bodies greater than 2.5 mm
4		Protection against solid bodies greater than 1 mm
5		Protection against dust (no harmful deposits)
6		Total protection against dust

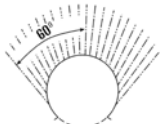
2nd digit Protection against liquids

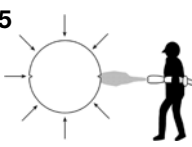
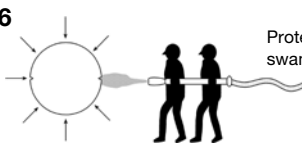
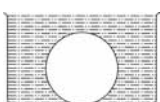
0		No protection Protection against vertical drops of water (condensation)
1		Protection against vertical drops of water (condensation)
2		Protection against drops of water falling up to 15° from vertical
3		Protection against rainwater up to 60° from vertical
4		Protection against water projected from all directions
5		protection against hosing with water from all directions
6		Protection against swamping with water
7		Protection against immersion

Example IP 55

- Protection against dust (no harmful deposits)
- Protection against hosing with water from all directions

Earth Loop Impedance Values for Miniature Circuit Breakers

Type iC60H		
Type B		
Rating	0.4 Sec	5 Sec
1A	43.70	43.70
2A	21.85	21.85
4A	10.93	10.93
6A	7.22	7.22
10A	4.37	4.37
16A	2.74	2.74
20A	2.19	2.19
25A	1.75	1.75
32A	1.37	1.37
40A	1.09	1.09
50A	0.87	0.87
63A	0.69	0.69

Type iC60H		
Type C		
Rating	0.4 Sec	5 Sec
1A	21.85	28.02
2A	10.93	13.66
4A	5.46	7.05
6A	3.69	4.65
10A	2.19	2.80
16A	1.37	1.75
20A	1.09	1.40
25A	0.87	1.12
32A	0.68	0.87
40A	0.55	0.70
50A	0.44	0.56
63A	0.35	0.45

Type iC60H		
Type D		
Rating	0.4 Sec	5 Sec
1A	15.61	28.02
2A	7.80	13.66
4A	3.90	7.05
6A	2.60	4.65
10A	1.56	2.80
16A	0.98	1.75
20A	0.78	1.40
25A	0.63	1.12
32A	0.48	0.87
40A	0.39	0.70
50A	0.31	0.56
63A	0.25	0.45

Type iC120H		
Type B		
Rating	0.4 Sec	5 Sec
63A	0.69	0.69
80A	0.54	0.54
100A	0.44	0.44
125A	0.34	0.34

Type iC120H		
Type C		
Rating	0.4 Sec	5 Sec
63A	0.37	0.45
80A	0.29	0.35
100A	0.23	0.28
125A	0.18	0.23

Type iC120H		
Type D		
Rating	0.4 Sec	5 Sec
63A	0.247	0.4275
80A	0.1995	0.3325
100A	0.152	0.266
125A	0.1235	0.2185

Type NSX

Acti 9 isobar distribution boards	pages 12/2 to 12/4
A type	page 12/2
B type	pages 12/3 to 12/4
Heavy duty distribution board 100A	page 12/5
Powerpact 4	pages 12/6 to 12/9
Powerboards and panelboards 250A and 400/630A	page 12/6
Powerboards and panelboards 250A, 400/630A and 800A	page 12/7
Extension boxes	page 12/8
Metering extensions	page 12/9
Panelboards 1600A	page 12/10
Safepact 2	page 12/11
MGF fusegear	page 12/12
Busbar chamber	page 12/13
Powerpact 4 pan assembly and incoming MCCB	page 12/14
Outgoing pan assembly 630A only	page 12/15
Outgoing pan assembly 800A only	page 12/16
Enclosures - Mini Opale, G9	page 12/17
Pragma surface mounted enclosures and interfaces	page 12/18
Kaedra	pages 12/19 to 12/22

BIM models are available on the Schneider Electric website
www.schneider-electric.co.uk

Acti 9 Isobar A type distribution boards

Part number	A	B	C
SEA9AN2	200	300	117
SEA9AN6	273	300	117
SEA9AN10, SEA9AN26DS	345	300	117
SEA9SNI4, SEA9AN26SL, SEA9AN66DS, SEA9AN616MS, SEA9ANI08MS	417	300	117
SEA9ANI8, SEA9AN6S6, SEA9AN5I0SL, SEA9AN96SL, SEA9ANI06DS, SEA9AN624MS, SEA9ANI016MS, SEA9ANI48MS	489	300	117
SEA9AN27, SEA9ANI0SI0, SEA9ANI432MS	417	530	117

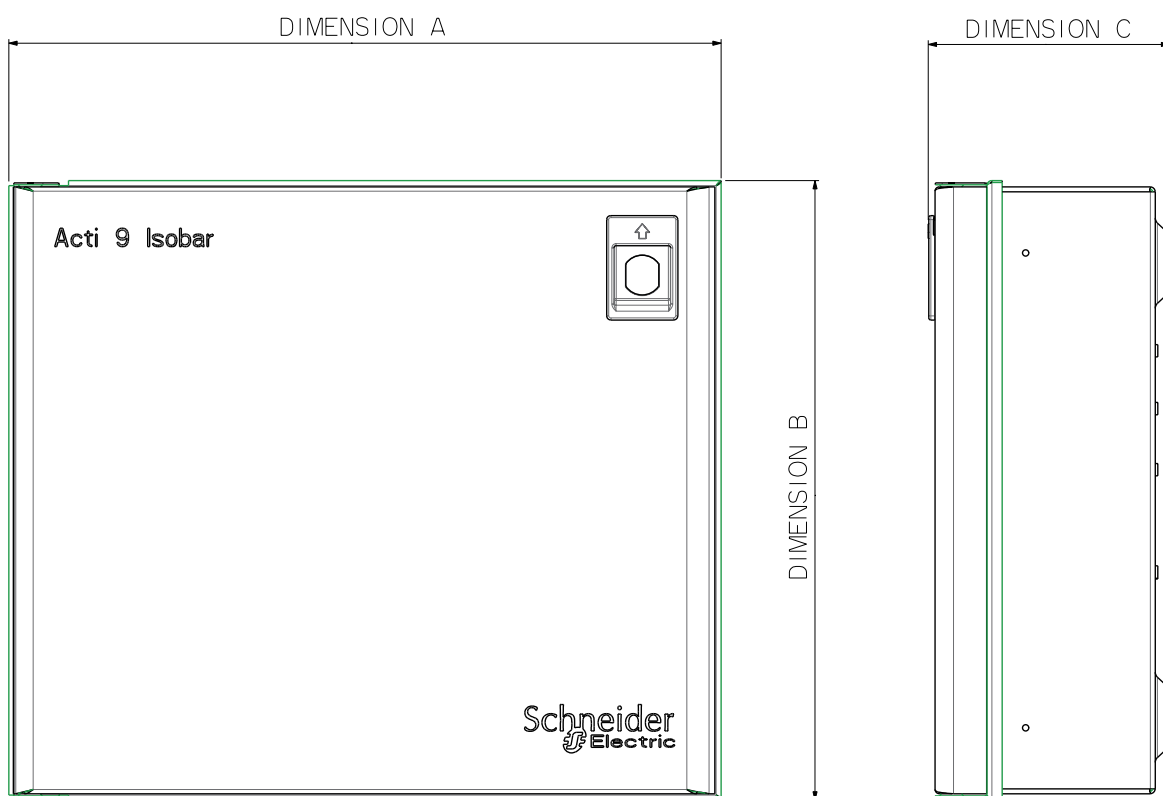

Key hole slot dimensions

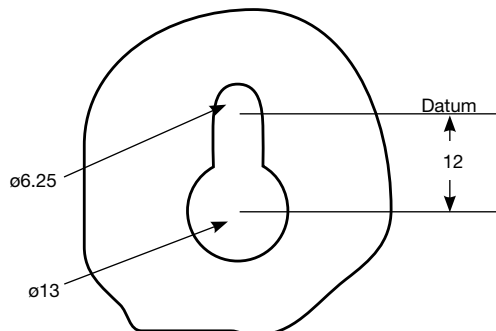

Acti 9 Isobar B type distribution boards

Part number	A	B
SEA9BN4, SEA9BN6, SEA9BN6M	484	386
SEA9BN8, SEA9BN8M	538	440
SEA9BN12, SEA9BN12M	700	602
SEA9BN16, SEA9BN16M	808	710
SEA9BN18, SEA9BN18M	862	764
SEA9BN24, SEA9BN24M	1024	926

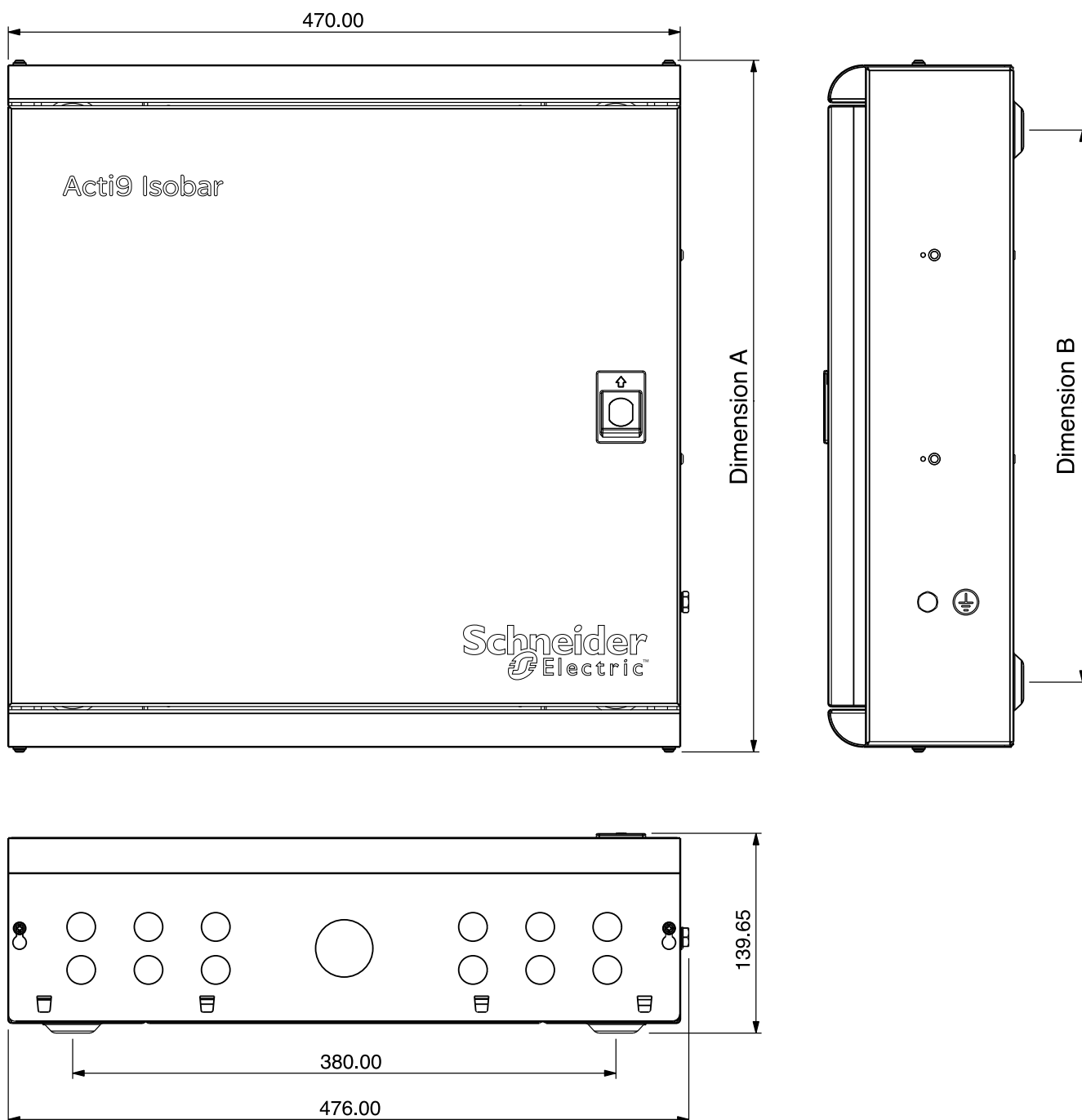

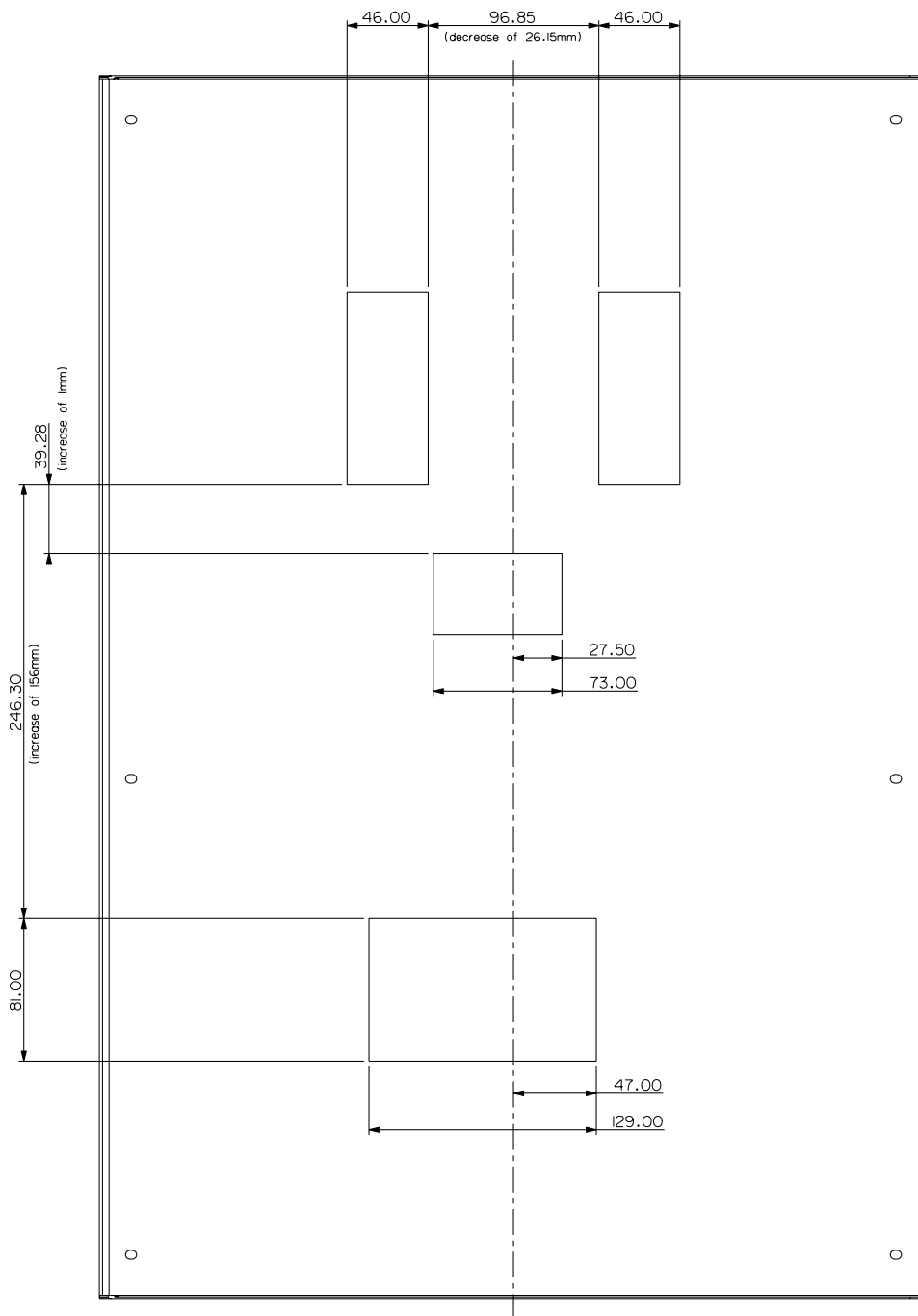

Heavy duty distribution board (100A) IP55 weatherproof

Part number	Number of	Dimensions (mm)		
		Height	Width	Depth
SEA9BN6HDGK/G-R	6	650	600	290*
SEA9BN8HDGK/G-R	8	650	600	290*
SEA9BN12HDGK/G-R	12	850	600	290*
SEA9BN16HDGK/G-R	16	850	600	290*

* Denotes the maximum depth dimensions with key fitted.

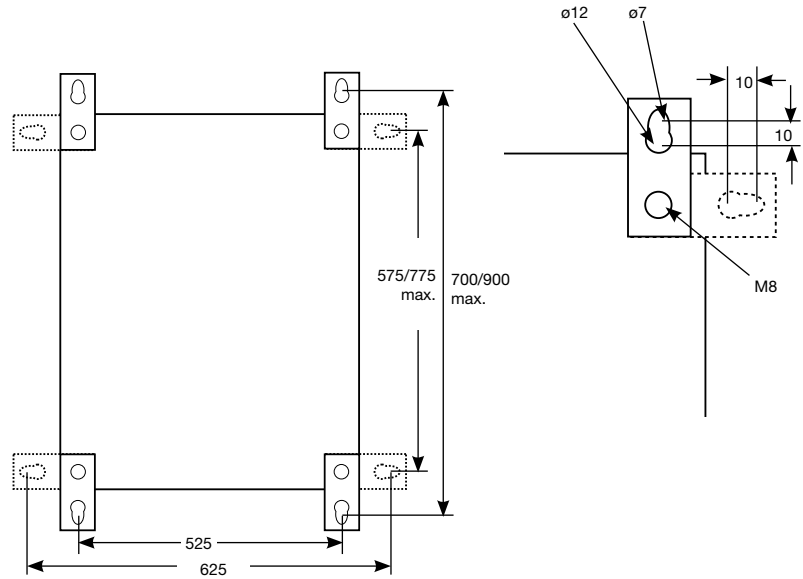

B board extension box enclosures

Part number	A
SEA9BNEXN	124
SEA9BNEX034N	140
SEA9BNKWH	124
SEA9BNEXA14N	140
SEA9BN100CCI	140
SEA9BNDSI	124

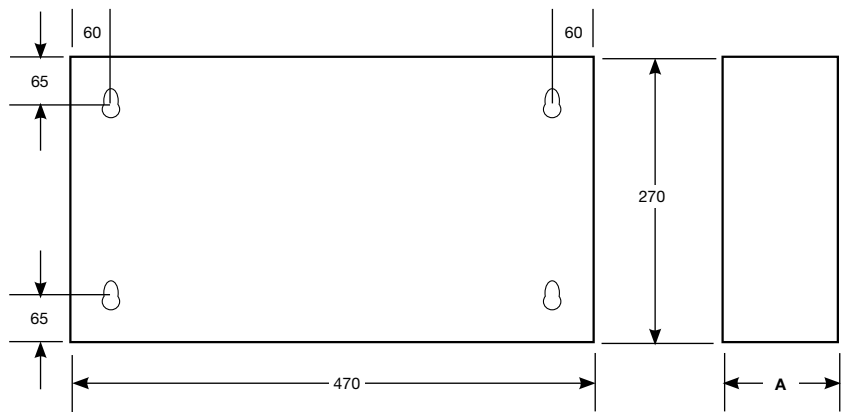

Powerpact 4 powerboards and panelboards 250A and 400/630A

250A powerboard

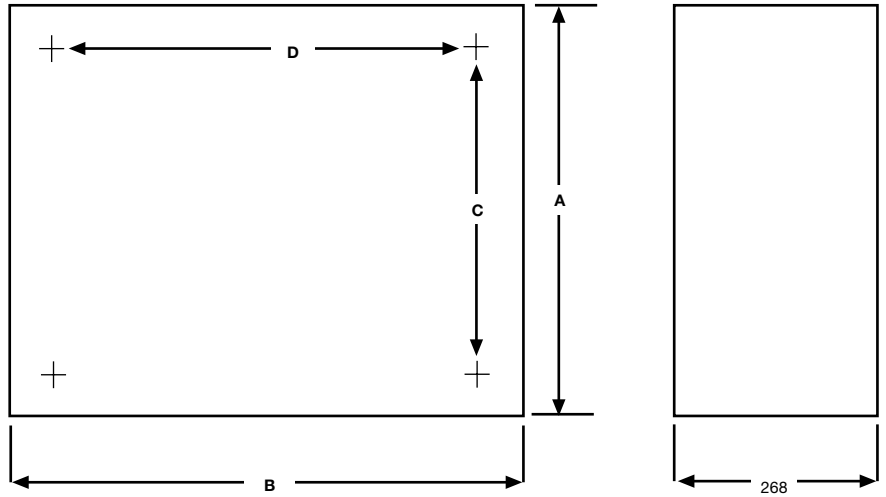

Board ref.	A	B	C	D
MG25C2 & MG25C2M	650	600	442	306
MG25C4 & MG25C4M	650	778	442	484
MG25EXC	650	600	442	306

C and D are the fixing dimensions about the centre line

250, 400/630A panelboard

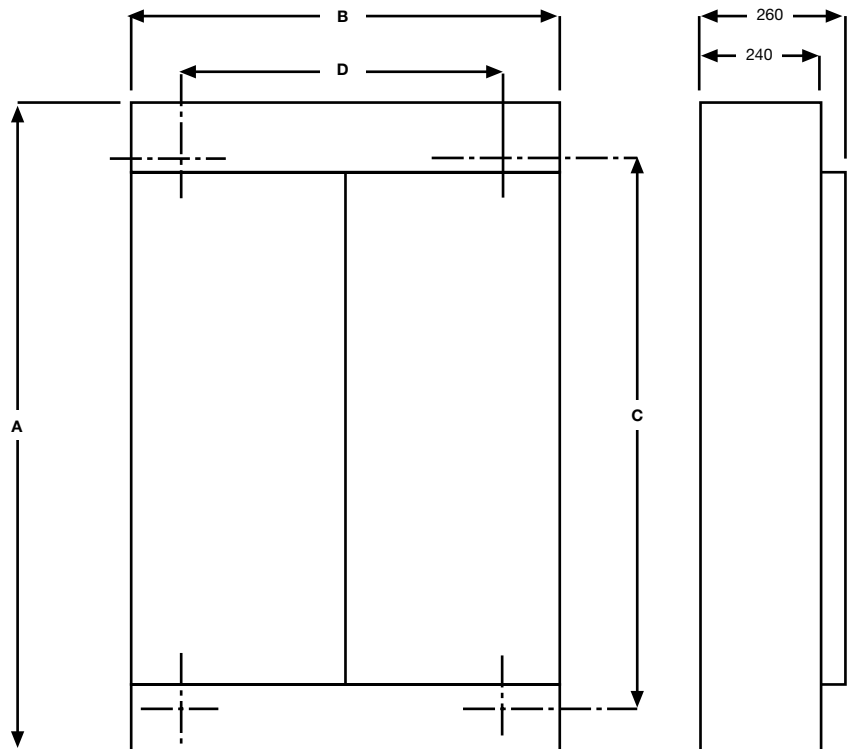

Board ref.	A	B	C	D
MG2C5	679	850	541	670
MG2C7	784	850	646	670
MG2C9	889	850	751	670
MG2C13	1074	850	920	670
MG6C6	1178	850	1035	710
MG6C12	1493	850	1350	710
MG6C18	1808	850	1665	710

C and D are the fixing dimensions about the centre line

Material thickness

1.2mm cover

1.6mm enclosure

Powerpact 4 powerboards and panelboards

250A, 400/630A and 800A

800A panelboard

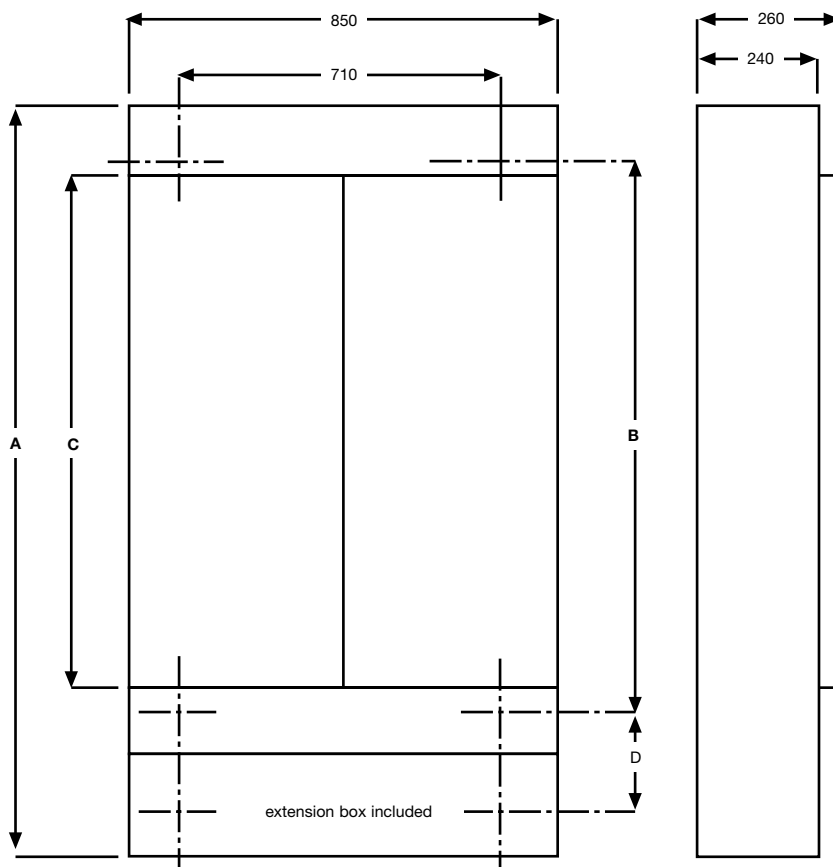

Board ref.	A	B	C	D
MG8C6	1578	1035	991	172
MG8C12	1893	1350	1306	172
MG8C18	2208	1665	1621	172

Material thickness
 1.2mm cover
 1.6mm enclosure

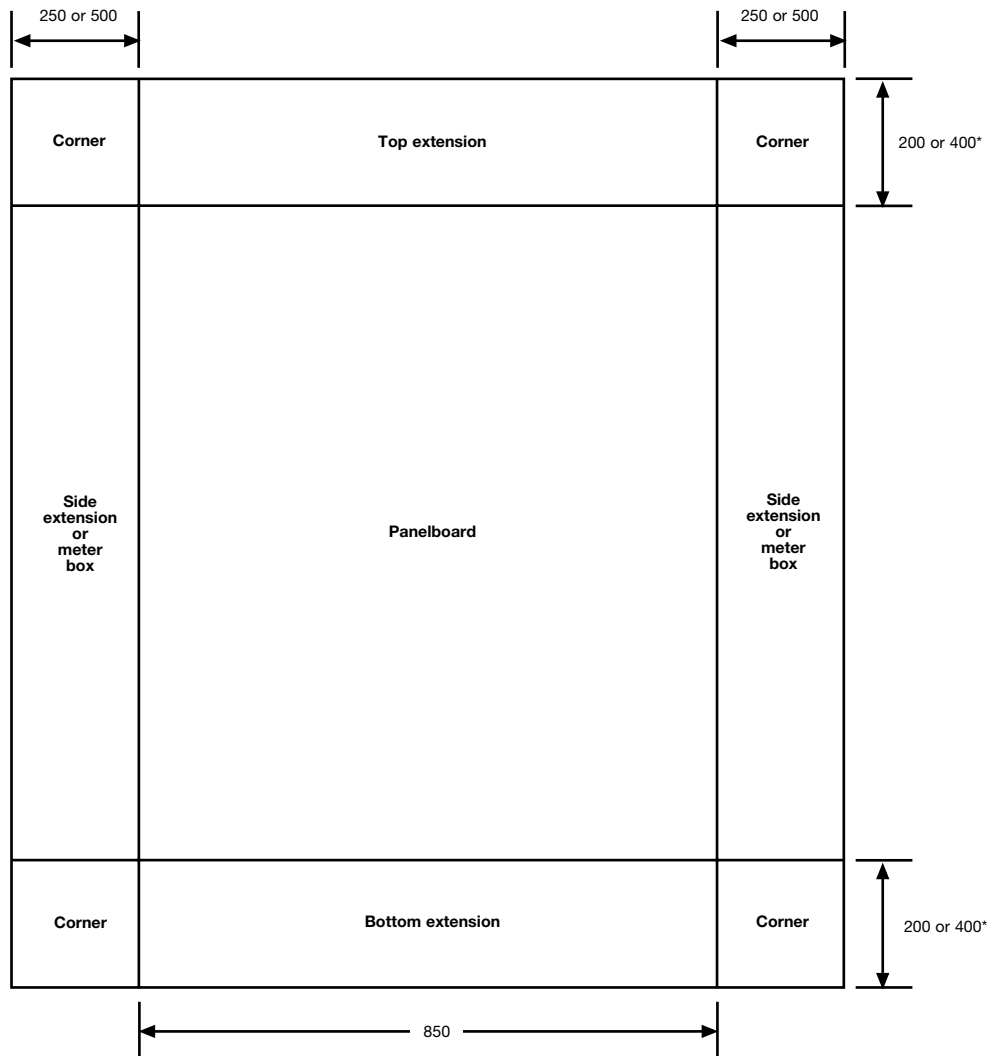

All extension boxes are the same depth as the main board - 240mm.

* 400mm extension box is fitted as standard at the incoming end of the 800A panelboard.

Corner units are available to suit all combinations of top/bottom and side extension boxes.

Overall dimension table

Panelboard Part number	MG25C2	MG25C2M	MG25C4	MG25C4M	MG2C5	MG2C7	MG2C9	MG2C13	MG6C6	MG6C12	MG6C18	MG8C6	MG8C12	MG8C18
Height Standard	653	653	653	653	679	784	889	1074	1178	1493	1808	1583	1898	2213
With 1 top or bottom ext box					883	988	1093	1278	1382	1697	2012	1787	2102	2417
with top & bottom ext box					1087	1192	1297	1482	1586	1901	2216	1991	2306	2621
Width Standard	600	600	778	778	850	850	850	850	850	850	850	850	850	850
with 1-250mm side ext box									1105	1105	1105	1105	1105	1105
with 1-500mm side ext box									1360	1360	1360	1360	1360	1360
with 1-600mm side ext box	1200	1200	1378	1378										
with 1-250 & 1-500mm side ext box								1615	1615	1615	1615	1615	1615	1615
with 2-250mm side ext boxes									1360	1360	1360	1360	1360	1360
with 2-500mm side ext boxes									1870	1870	1870	1870	1870	1870
Depth	263	263	263	263	263	263	263	263	263	263	263	263	263	263

Dimensions (mm)

Powerpact 4 metering extensions 630, 800A panelboard with side extension metering boxes

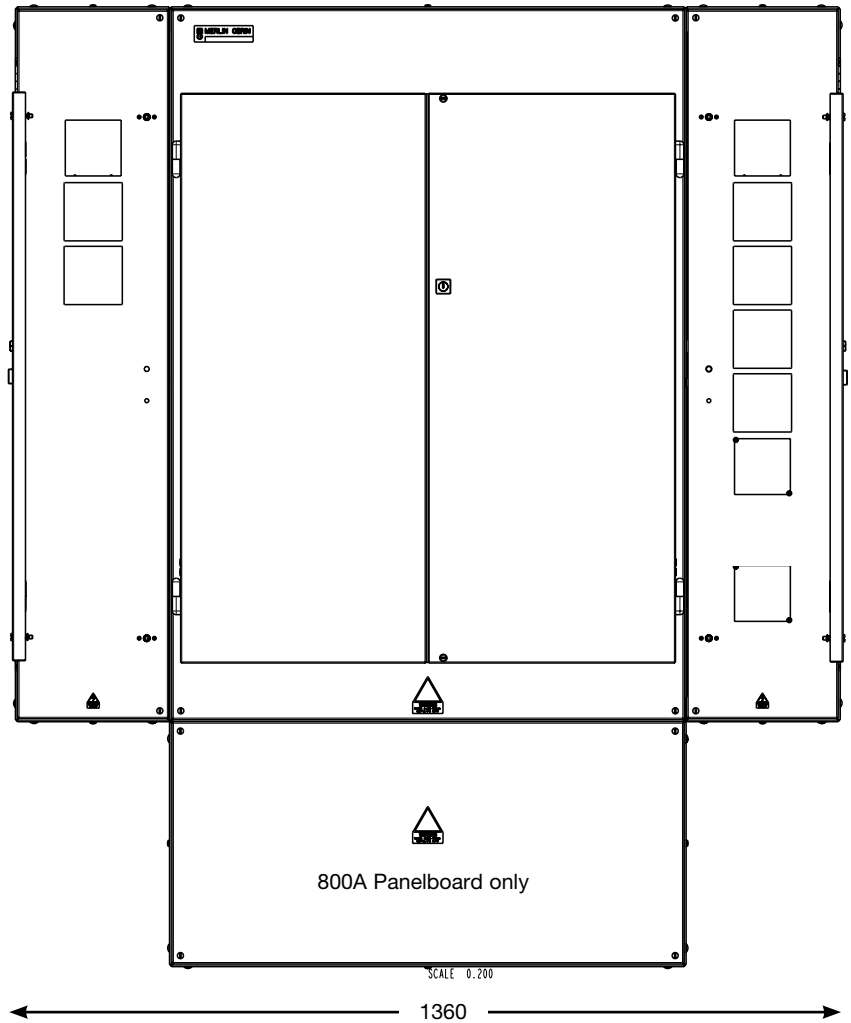

The side extensions with metering are dimensionally the same as standard 250mm side extensions

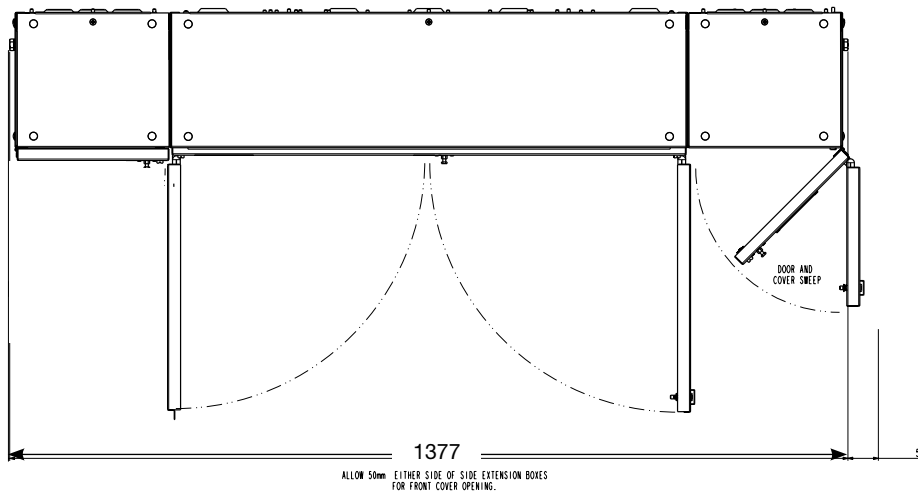

All apertures are 92mmsq. to accept standard DIN 96 meters.

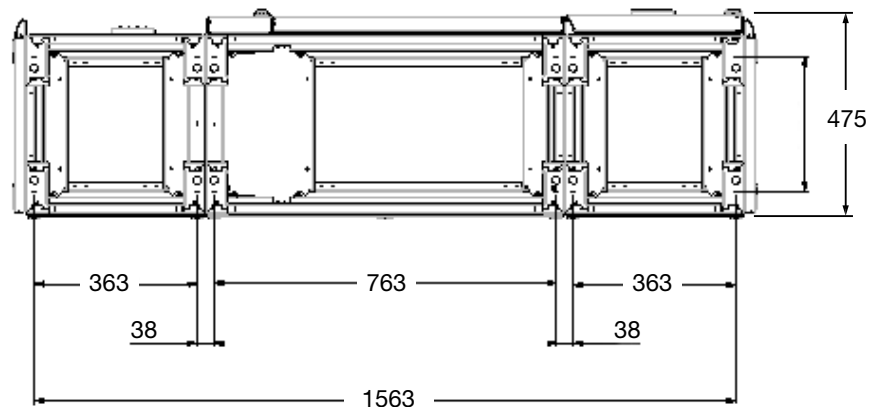
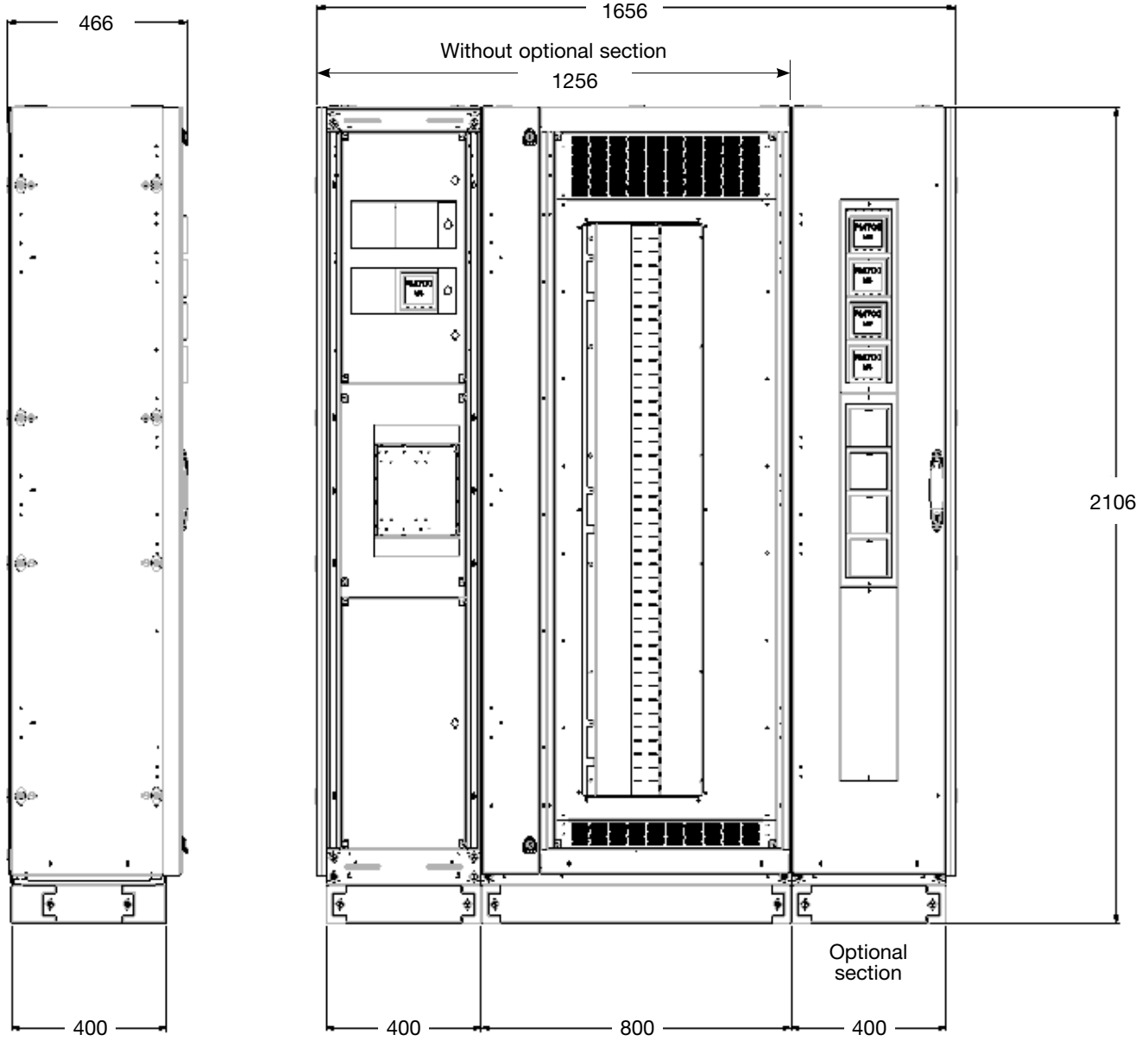

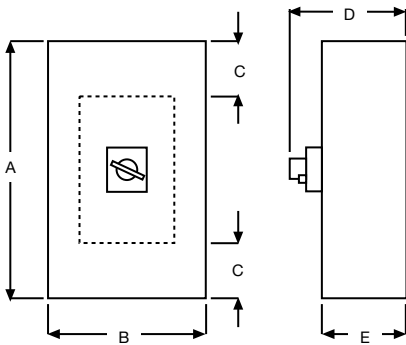

Safepact 2 MCCB or switch disconnecter general purpose enclosure IP40

Rating	Height	Width	Cable space	Overall depth	Enclosure depth
	A	B	C	D	E
Up to 250A	420	230	140	211	145
630A	700	356	236	235	169

Note: C* - we recommend fitting cable extension boxes on each end of the 160, 250 and 630A ratings, unless utilising trunking

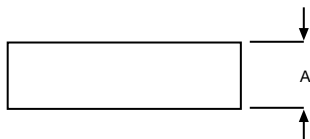

Extension boxes for Safepact 2 MCCB enclosures

Height (A)	Part number
100	MGEX 160C
200	MGEX 250C
120	MGEX 630C

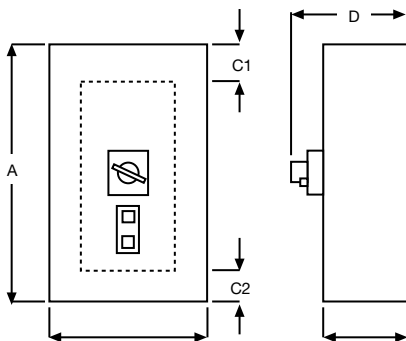

Safepact 2 MCCB or switch disconnecter general purpose enclosure IP40 including earth leakage

Rating	Height	Width	Cable space		Overall depth	Enclosure depth	
	A	B	C1	C2	D	E	
Up to 100A	100A	420	230	140	65	211	145
	160A	520	230	140	165		
	250A	620	230	140	265		
400A	820	356	236	256	235	169	
630A							

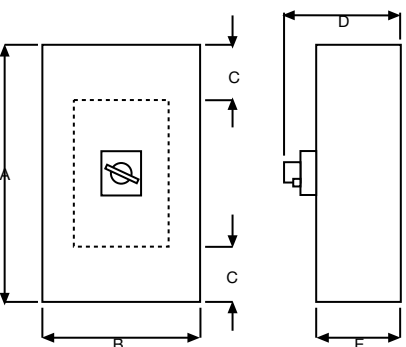

Enclosed Interpact

Rating	Height	Width	Cable space	Overall depth	Enclosure depth
	A	B	C	D	E
63A	350	350	130	300	250
100A	350	350	125	300	250
160A	350	350	125	300	250
250A	450	350	165	300	250
320A	650	350	235	300	250
400A	650	350	235	300	250
500A	650	350	235	300	250
630A	650	350	235	300	250

Switch disconnecter fuse MGFA
Switch disconnecter MGFL

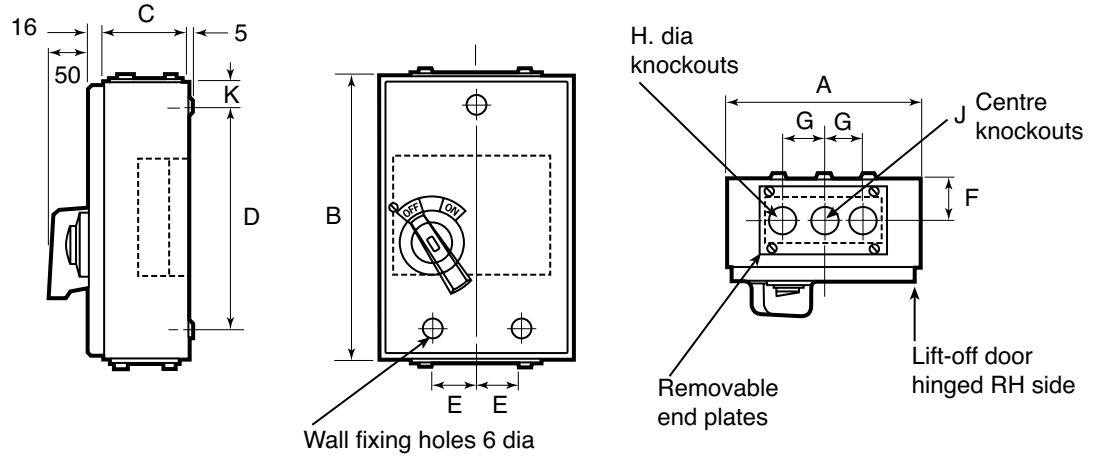

Rating	A	B	C	D	E	F	G	H	J	Weight Kg*
20A	210	240	105	160	50	51	44	20	25	4.10
32A	210	240	105	160	50	51	44	20	25	4.82
63A	235	350	105	270	55	51	50	32	32	5.34
100A	260	400	120	320	65	51	60	38	40	7.37

* Weights do not include the fuse links

Fuse switch disconnecter MGFS
Switch disconnecter MGFD

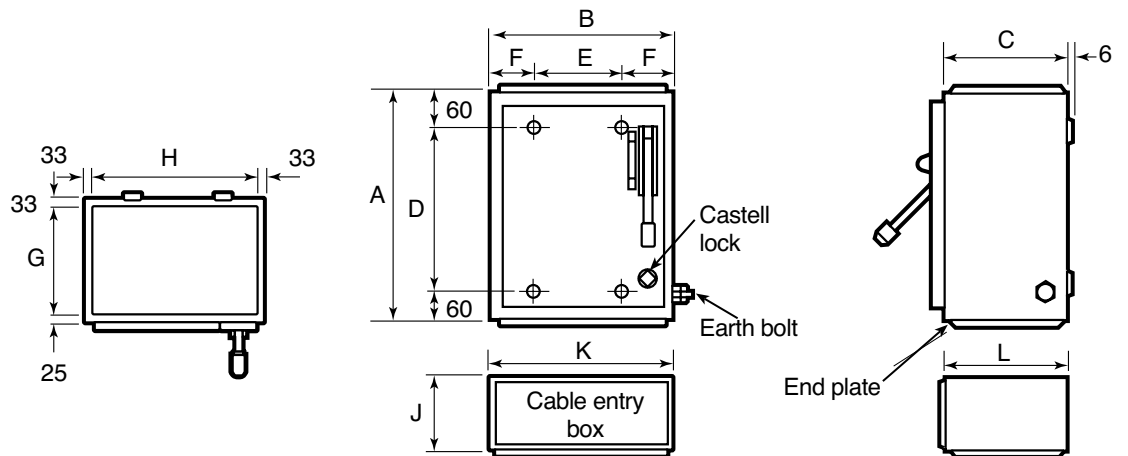

Rating	A	B	C	D	E	F	G	H	J	K	L	Weight Kg*
100A	380	292	200	260	130	81	142	226	100	292	220	15.6
160A	380	292	200	260	130	81	142	226	150	292	220	15.6
200/ 250A	380	340	200	260	180	80	142	274	180	340	220	19.5
400A	455	489	270	335	289	100	212	423	300	489	290	36.2
500A	455	489	270	335	289	100	212	423	300	489	290	36.2
630A	455	489	270	335	289	100	212	423	400	489	290	36.2

* Weights do not include the fuse links

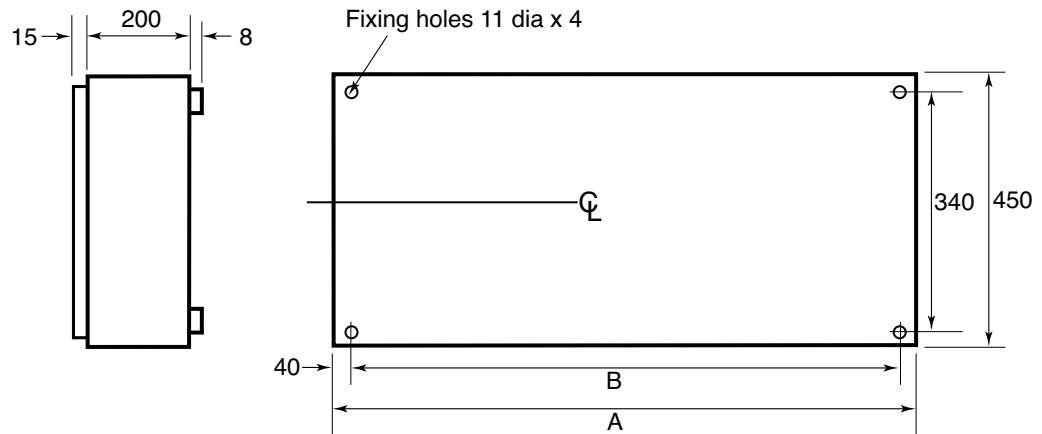

Type	A	B
MBFB...07TN	750	670
MBFB...12TN	1200	1120
MBFB...18TN	1800	1720

Reference	A
6 way	346
12 way	661
18 way	976
24 way	1291
30 way	1606

Reference	C
NS800	475
NS630	330
NS250	228

Dimension C = centre line of incoming breaker terminals (plan view).

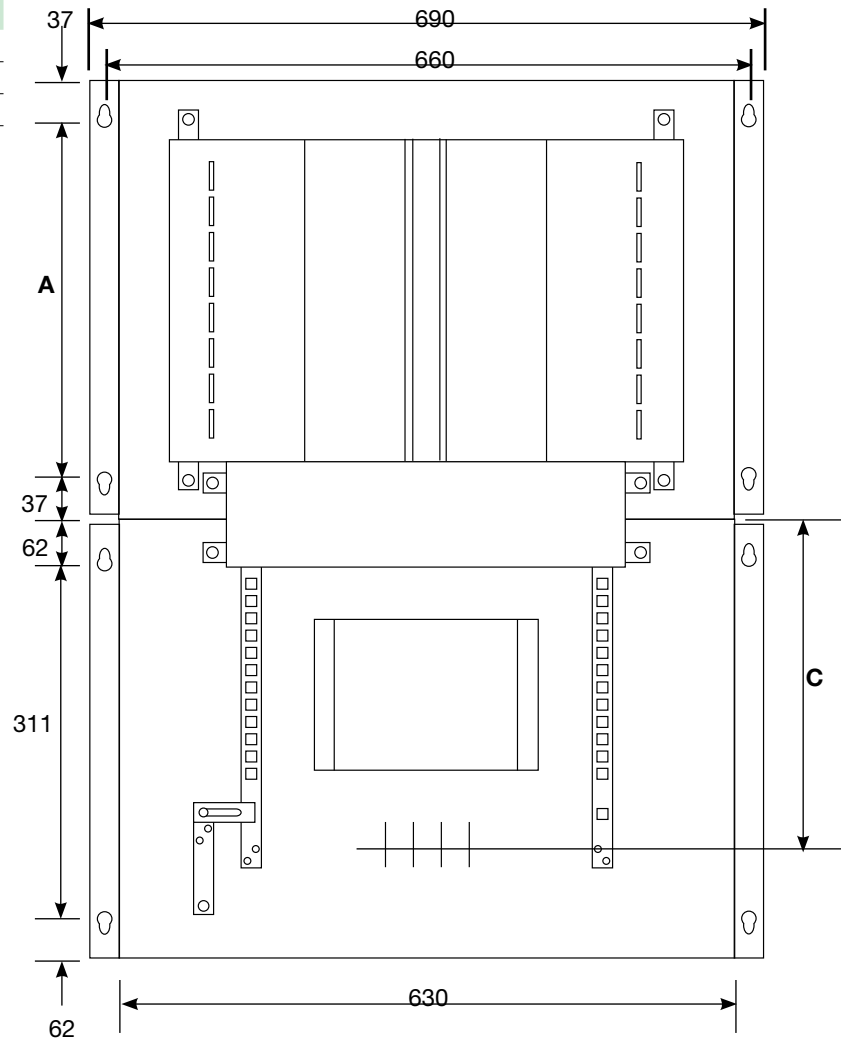

NS250 incoming MCCB connections

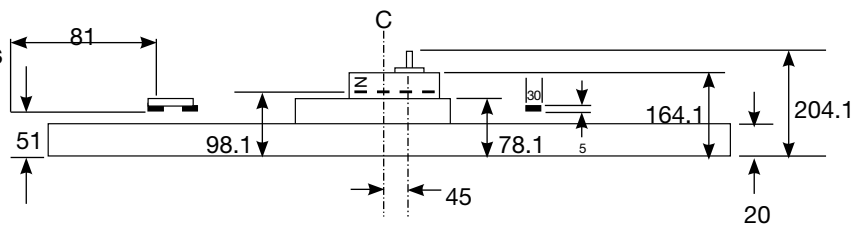

NS630 incoming MCCB connections

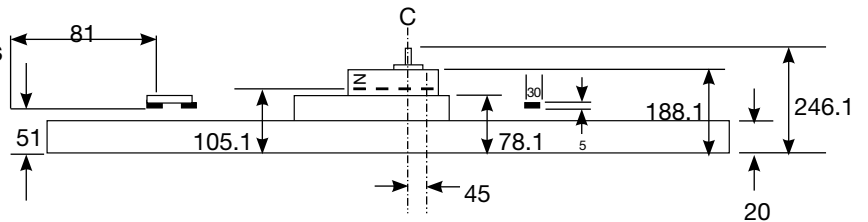

NS800 incoming MCCB connections

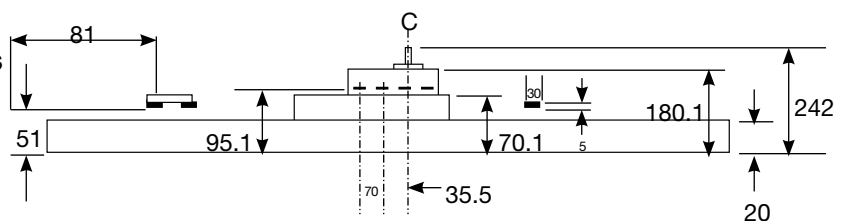

Dimensions (mm)

Outgoing pan assembly 630A only

Reference	A
6 way	346
12 way	661
18 way	976
24 way	1291
30 way	1606

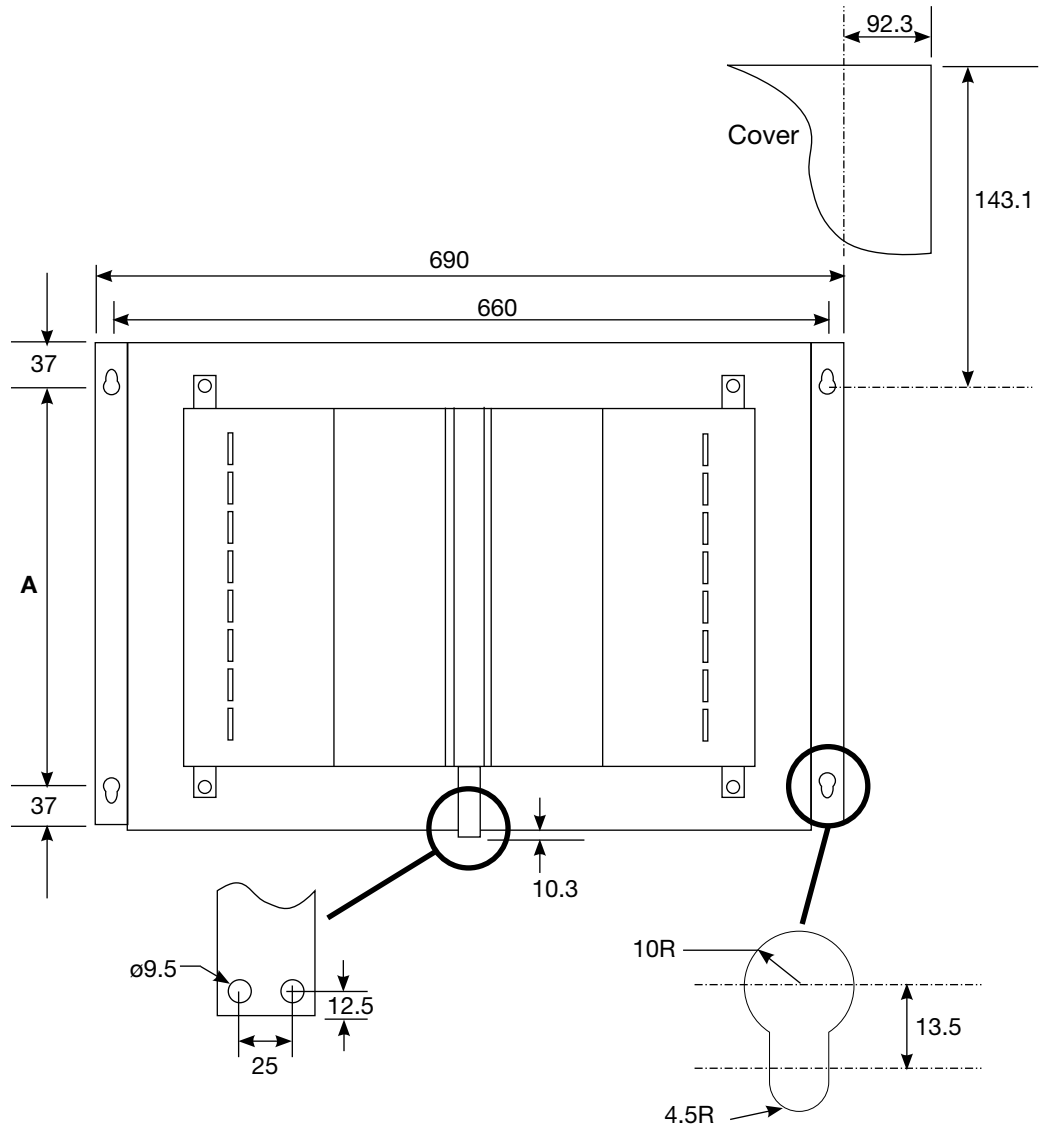

Incoming busbar connections direct to outgoing pan assembly

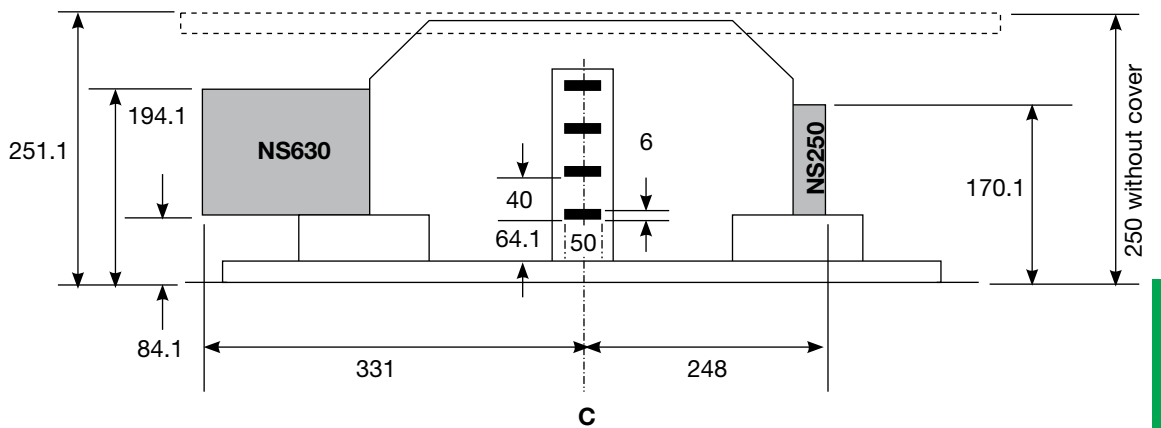

Dimensions (mm)

Outgoing pan assembly 800A only

Reference	A
6 way	346
12 way	661
18 way	976
24 way	1291
30 way	1606

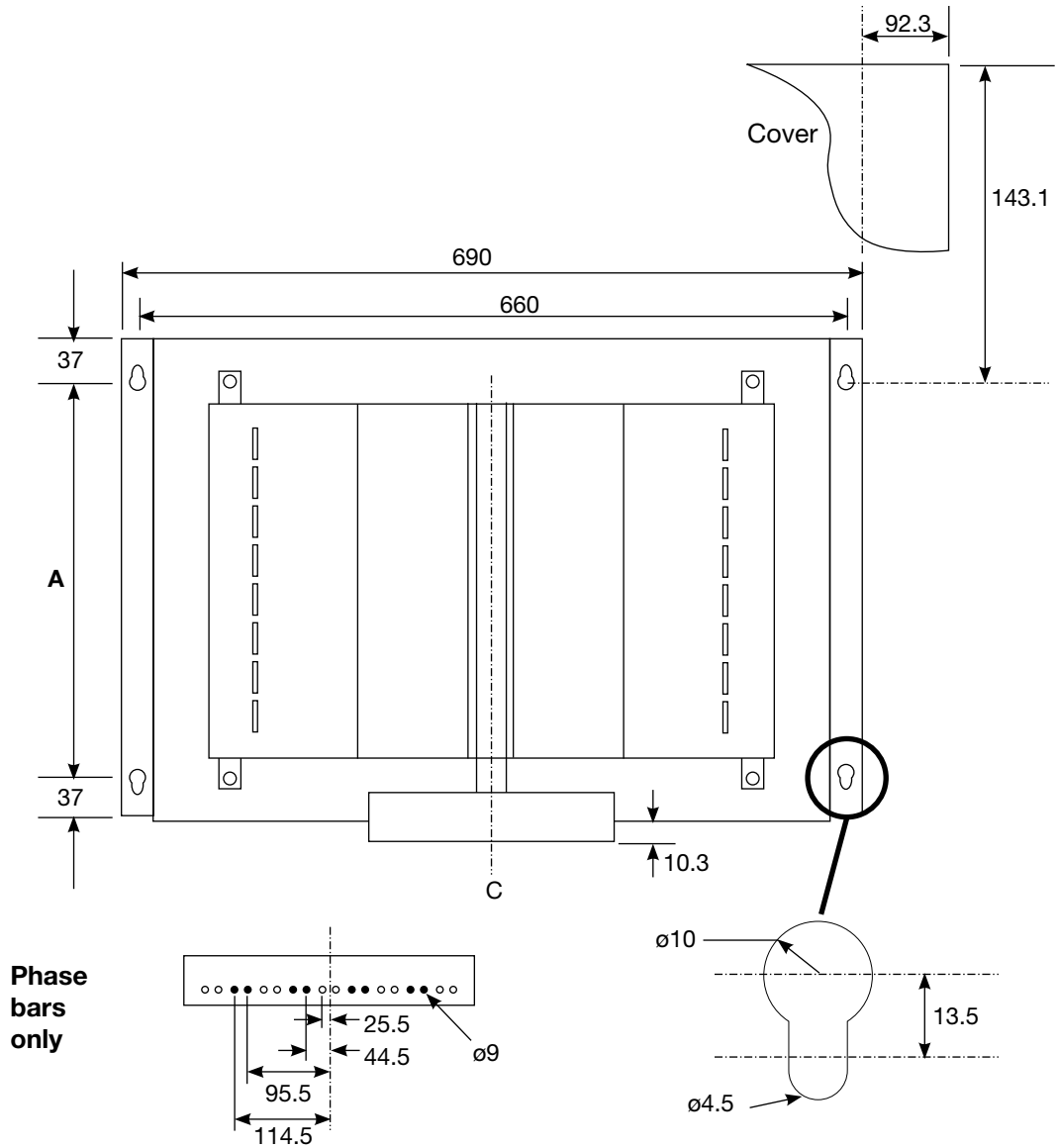

Incoming busbar connections direct to outgoing pan assembly

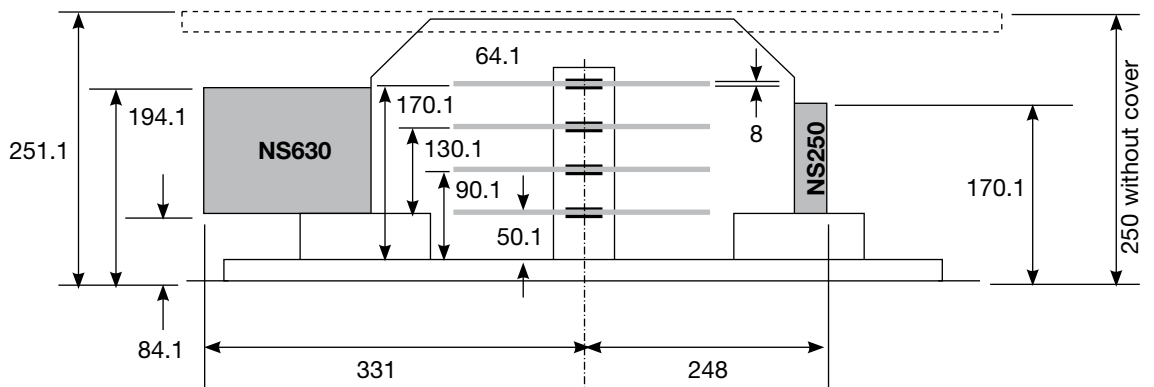

Mini Opale enclosures

Part number	H	W	D	A	B	E
13392	130	44	57	36	65	11
13394	130	80	57	72	65	11
13396	160	119	65	108	80	19
13398	160	155	65	151	80	19

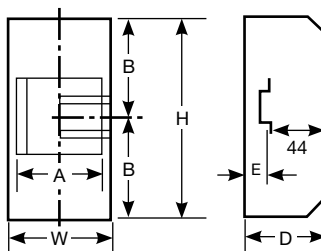

G9 enclosures

Part number	A
14599	72
14603	99

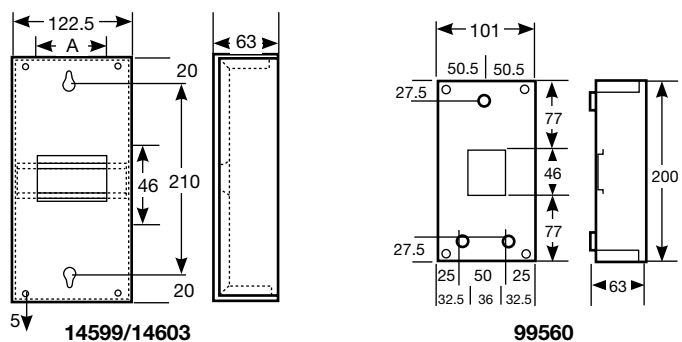

Enclosures Pragma surface mounted enclosures and interfaces

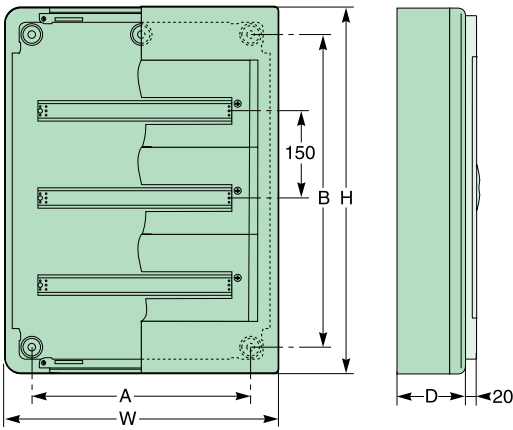

Surface mounted enclosures

Enclosure		Dimensions (mm)							G	J
		H	W	D	A	B	E	F		
13 modules	1R	300	336	123 (115)	160	200	73	253	149	
	2R	450				350				
	3R	600				500				
	4R	750				650				
24 modules	1R	300	550	148 (136)	340	150	84			121
	2R	450				300				271
	3R	600				450				421
	4R	750				600				571
	5R	900				750				721
	6R	1050				900				871

Panel for customisation of the transparent door 13 module enclosures

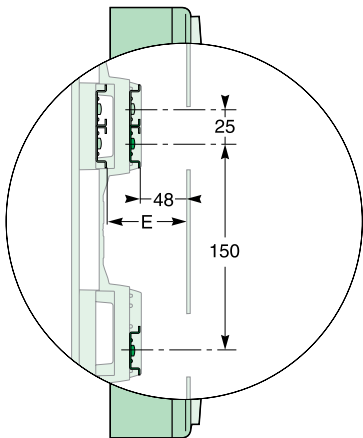

The different positions of the DIN rail in height and depth.

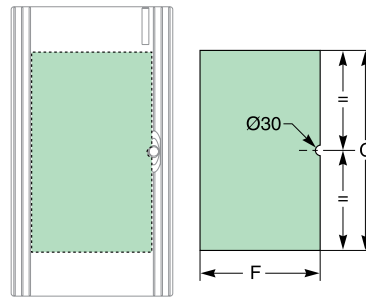

Panel thickness: 0.5 mm max.

24 module enclosures

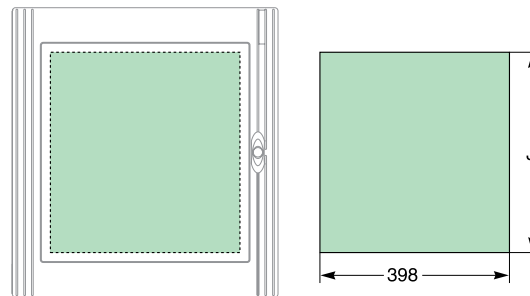

Panel thickness: 0.5 mm max.

Interfaces

Enclosure	Associated with enclosure	Dimensions (mm)			
		H	W	D	B
1R	13 modules	300	200	115	206
2R		450			356
3R		600			506
1R	24 modules	300	200	136	175
2R		450			325
3R		600			475

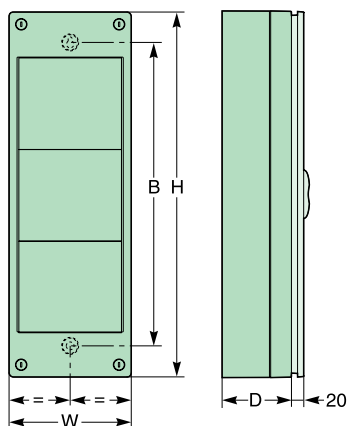

Pre-cutouts

The new European standard EN 50262 generalises metric dimensions for cable glands.

To simplify the transition, the entire Kaedra range is equipped with pre-cutouts both in ISO/metric standardisation and in PG standardisation. Each pre-cutout is marked:

■ Simple pre-cutout adapted to the metric cable gland:



■ Double pre-cutout:

□ External: pre-cutout adapted to the metric cable gland/ISO

□ Internal: pre-cutout adapted to the PG cable gland



Cable glands

Type of pre-cutout	For cables of diameter (mm)
M16	4 - 8
M20	6 - 12
M25	12 - 18
M32	18 - 25
M50	30 - 38
PG11	5 - 10
PG16	10 - 14
PG21	14 - 17
PG29	19 - 26
PG36	22 - 32

Associations

The enclosures can be associated:

■ Horizontally, regardless of their height (see diagram below)

■ Vertically, if their width is identical.

Use the association kit, Part number 13934 (2 sleeves + 4 nuts + 4 seals) in the M32 pre-cutouts marked with a double arrow.

Insertion of cables between the enclosures is possible, while preserving the degree of protection IP65.

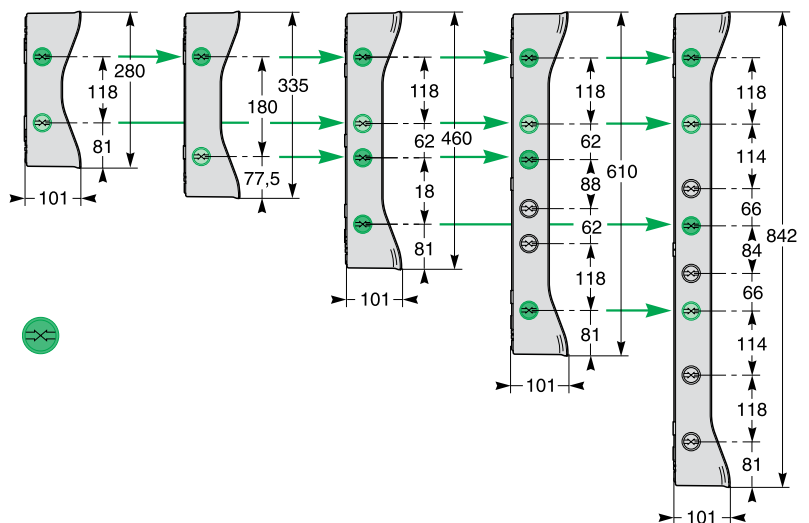

Weatherproof mini enclosures
Weatherproof mini enclosures for power outlets

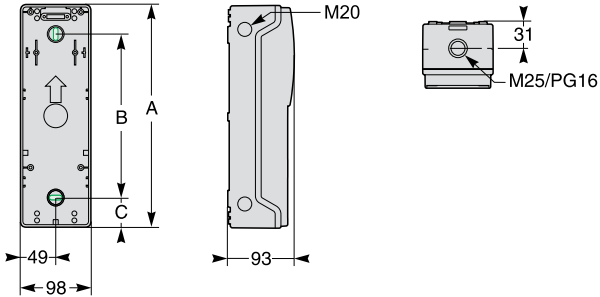

A	B	C	Weight (g)
248	166	41	550
310	228	41	600
392	310	41	700

Weatherproof mini enclosures for modular switchgear

3 modules

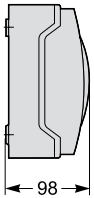

4, 6, 8 and 12 modules

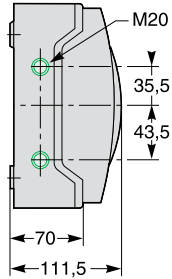

Number of modules	A	L	Weight (g)
3	-	80	300
4	-	123	500
6	-	159	650
8	88	195	850
12	160	267	1050

3 modules

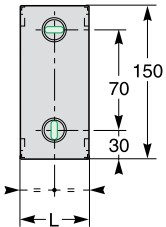

4 and 6 modules

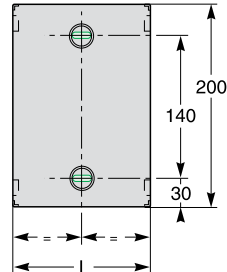

8 and 12 modules

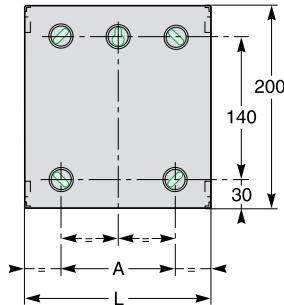

3 modules

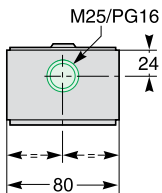

4 modules

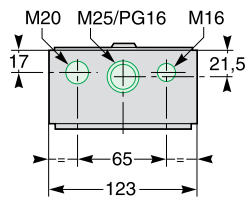

6 modules

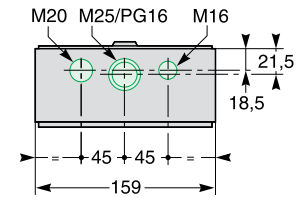

8 modules

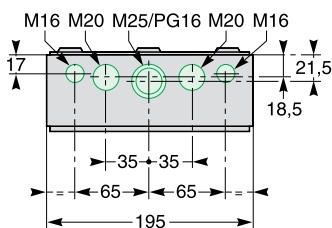

12 modules

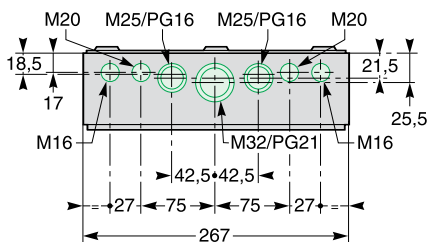

A	B	C	Weight (g)
460	251	104.5	1450
460	251	104.5	1250
460	251	104.5	1400
460	251	104.5	1400
610	490	60	1650

Weatherproof enclosures

5 modules

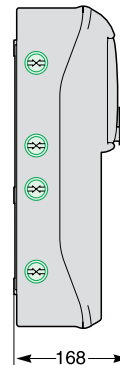
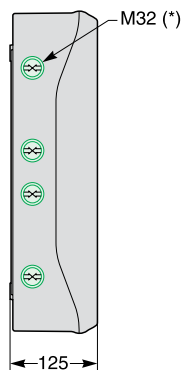
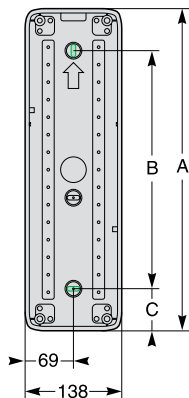
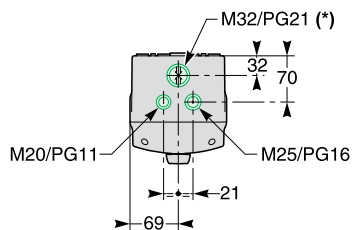

(*) pre-punchout also used for enclosure association

A	B	C	Weight (g)
460	251	104.5	2050
460	251	104.5	1900
460	251	104.5	1900

8 modules

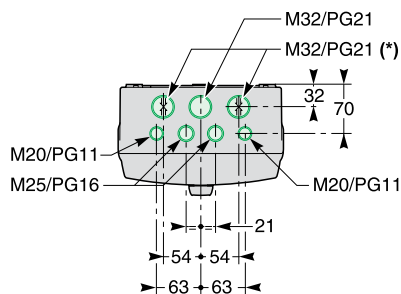
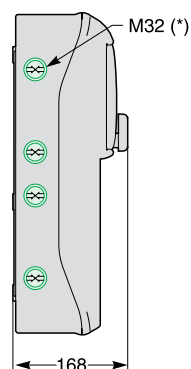
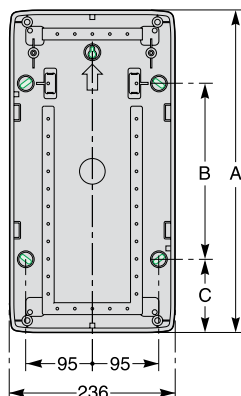

(*) pre-punchout also used for enclosure association

Dimensions (mm)

Kaedra (cont.)

A	B	C	Weight (g)
280	118	81	1900
335	170	82.5	2200
335	170	82.5	2150
460	251	104.5	3100
460	251	104.5	2850
460	251	104.5	3300
460	251	104.5	2650
460	251	104.5	2700
610	401	104.5	4100
460	251	104.5	4550

Weatherproof enclosures 12-13 modules

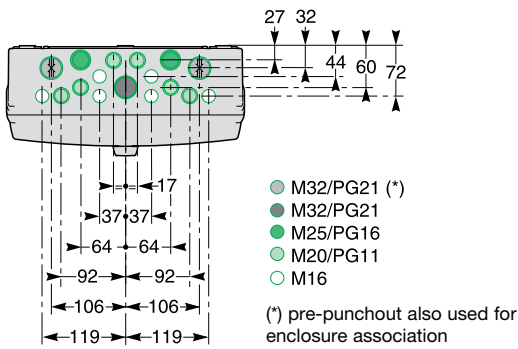
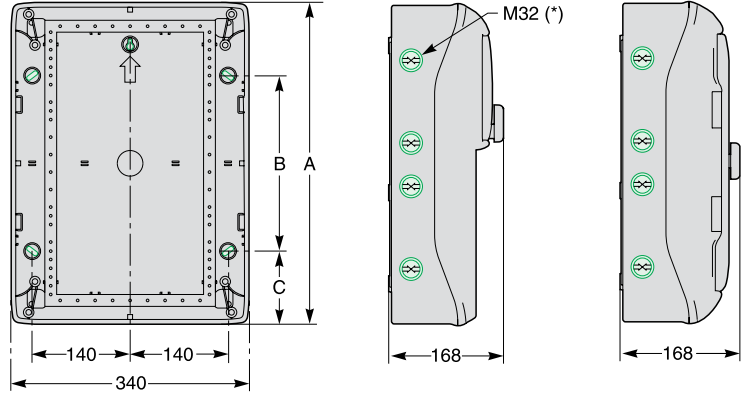

A	B	C	Weight (g)
280	118	81	2400
280	118	81	1950
460	251	104.5	3850
460	251	104.5	3550
460	251	104.5	4150
460	251	104.5	3200
460	251	104.5	3150
460	251	104.5	3300
610	401	104.5	3150
610	401	104.5	5600
610	401	104.5	4050
842	633	104.5	6500
842	633	104.5	6600

18-19 modules

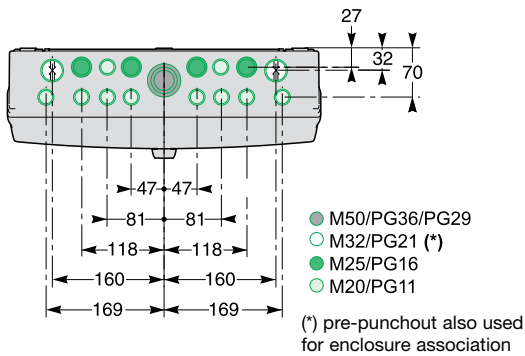
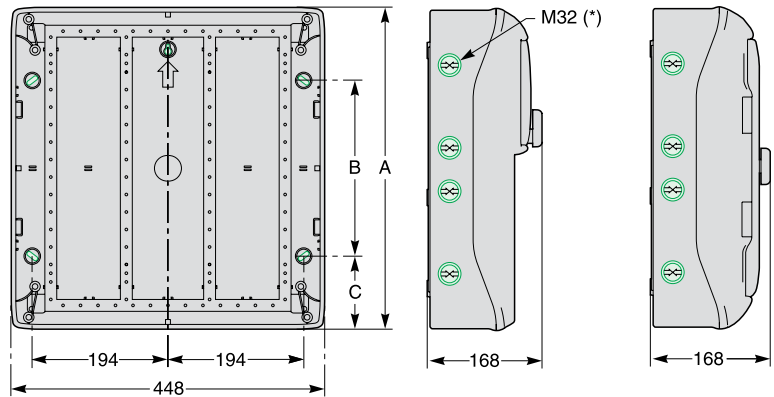

Product list

Reference	Page	Reference	Page	Reference	Page	Reference	Page
3908	8/21	13410	10/17	14813	10/5	16361	4/4
04224	10/10	13411	10/17	14814	10/5	16363	4/2
8908	8/20	13412	10/17	14818	10/5	16363	4/4
8961	8/16	13441	10/25	14885	10/5	16550	7/101
8962	8/16	13442	10/25	14915	10/10	16552	7/101
8963	8/16	13443	10/25	14962	10/9	16553	7/101
10209	10/33	13444	10/25	14963	10/9	16643	4/4
10210	10/33	13445	10/33	14964	10/9	16644	4/4
10220	10/33	13446	10/33	14965	10/9	16645	4/4
10405	10/4	13448	10/33	14975	10/9	16646	4/4
10545	10/4	13450	10/33	14976	10/9	17400	3/18
10546	10/4	13595	10/33	14977	10/9	18264	5/2
10547	10/4	13599	10/33	14979	10/9	18265	5/2
13135	10/33	13735	10/33	15111	7/35	18266	5/2
13136	10/33	13735	10/17	15112	7/35	18267	5/2
13137	10/33	13736	10/33	15113	7/35	18268	5/2
13138	10/33	13736	10/17	15114	7/36	18269	5/2
13139	10/33	13929	10/33	15125	7/49	18280	5/2
13140	10/33	13934	10/33	15125	7/49	18281	5/2
13141	10/33	13935	10/33	15126	7/49	18526	3/17
13142	10/33	13936	10/33	15126	7/49	18527	3/17
13143	10/33	13937	10/33	15151	7/51	18528	3/18
13144	10/33	13938	10/33	15201	7/87	18687	5/2
13175	10/19	13939	10/33	15202	7/87	18688	5/2
13175	10/19	13940	10/33	15208	7/87	18689	5/2
13176	10/19	13941	10/33	15209	7/87	18690	5/2
13176	10/19	13944	10/33	15228	7/39	18691	5/2
13177	10/19	13945	10/33	15229	7/39	18692	5/2
13177	10/19	13946	10/33	15281	7/84	18693	5/9
13178	10/19	13947	10/33	15331	7/73	18695	5/9
13179	10/19	13948	10/33	15331	7/73	19091	2/27
13180	10/19	13949	10/33	15335	7/73	19091	3/18
13181	10/19	13950	10/33	15335	7/73	19096	2/27
13182	10/19	13975	10/19	15336	7/73	19096	3/18
13189	10/27	13981	10/25	15336	7/73	19512	10/4
13190	10/27	13982	10/25	15337	7/72	19516	10/4
13191	10/27	13983	10/25	15341	7/75	20267	10/10
13192	10/27	13984	10/25	15359	7/63	21089	10/4
13193	10/27	13985	10/25	15363	7/62	21093	10/4
13195	10/27	13986	10/25	15366	7/73	21094	10/4
13196	10/27	13987	10/25	15440	7/109	21095	10/4
13197	10/27	13990	10/22	15443	7/109	21096	10/4
13198	10/27	13991	10/22	15482	7/82	21098	10/4
13199	10/27	13992	10/22	15483	7/82	21100	3/24
13260	10/33	13993	10/19	15668	7/44	21101	3/24
13361	10/33	13993	10/28	15669	7/44	21102	3/24
13362	10/33	13994	10/19	16314	4/4	21103	3/24
13363	10/33	13994	10/28	16315	4/4	21104	3/24
13364	10/33	14190	10/33	16316	4/4	21105	3/24
13387	10/17	14210	10/10	16317	4/4	21106	3/24
13392	10/12	14211	10/10	16330	4/2	21107	3/24
13394	10/12	14599	10/12	16330	4/4	21108	3/24
13396	10/12	14603	10/12	16332	4/2	21109	3/24
13398	10/12	14811	10/5	16332	4/4	21110	3/24
13409	10/17	14812	10/5	16361	4/2	21111	3/24

Product list

Reference	Page	Reference	Page	Reference	Page	Reference	Page
21112	3/24	33566	8/7	A9A26960	2/20	A9C20642	7/4
21113	3/24	33566	8/9	A9A26961	2/20	A9C20643	7/4
21115	3/24	33568	8/7	A9A26963	2/20	A9C20663	7/4
21116	3/26	33568	8/9	A9A26969	2/20	A9C20731	7/4
21117	3/26	33570	8/7	A9A26970	2/25	A9C20732	7/4
21118	3/26	33570	8/9	A9A26971	2/20	A9C20736	7/4
21119	3/26	44936	8/17	A9A26975	2/26	A9C20833	7/4
21120	3/26	83992	10/33	A9A26976	2/26	A9C20834	7/4
21121	3/26	83993	10/33	A9A26981	2/26	A9C20837	7/4
21122	3/26	83994	10/33	A9A26982	2/26	A9C20838	7/4
21123	3/26	83995	10/33	A9A27001	2/26	A9C20842	7/4
21124	3/26	83996	10/33	A9A27003	2/24	A9C20843	7/4
21125	3/26	83997	10/33	A9A27005	2/24	A9C20844	7/4
21127	3/26	99217	10/10	A9A27006	2/24	A9C20847	7/4
21128	3/26	99219	10/10	A9A27008	2/24	A9C20862	7/4
21129	3/26	99221	10/10	A9A27049	2/25	A9C20863	7/4
21130	3/26	99223	10/10	A9A27062	2/26	A9C20864	7/4
21133	3/27	99225	10/10	A9A27063	2/26	A9C20867	7/4
21501	10/4	99560	10/12	A9C15032	7/27	A9C20868	7/4
21501	10/4	99246A	10/10	A9C15404	7/22	A9C20869	7/4
21503	10/4	99246B	10/10	A9C15405	7/22	A9C20882	7/4
21503	10/4	A9A15096	7/36	A9C15409	7/22	A9C20884	7/4
21505	10/4	A9A15151	7/51	A9C15410	7/22	A9C21132	7/5
21507	10/4	A9A15152	7/51	A9C15412	7/23	A9C21134	7/5
21507	10/4	A9A15212	7/39	A9C15413	7/23	A9C21142	7/5
26970	3/16	A9A15213	7/39	A9C15414	7/23	A9C21144	7/5
26975	3/17	A9A15214	7/39	A9C15415	7/9	A9C21162	7/5
26976	3/17	A9A15215	7/39	A9C15419	7/9	A9C21164	7/5
26981	3/17	A9A15216	7/39	A9C15424	7/24	A9C21442	7/5
26996	3/16	A9A15218	7/39	A9C15914	7/9	A9C21532	7/5
26997	3/16	A9A15219	7/39	A9C15915	7/9	A9C21642	7/5
27001	3/17	A9A15220	7/39	A9C15916	7/9	A9C21732	7/5
27046	3/16	A9A15222	7/39	A9C15918	7/9	A9C21833	7/5
27047	3/16	A9A15320	7/41	A9C15919	7/9	A9C21834	7/5
27048	3/16	A9A15321	7/41	A9C15920	7/9	A9C21842	7/5
27049	2/5	A9A15322	7/41	A9C15921	7/13	A9C21843	7/5
27053	2/27	A9A15323	7/41	A9C15922	7/13	A9C21844	7/5
27053	3/18	A9A15393	7/56	A9C15923	7/13	A9C21862	7/5
27060	2/27	A9A15416	7/56	A9C15924	7/9	A9C21864	7/5
27060	3/18	A9A15921	7/9	A9C18308	7/9	A9C22011	7/4
27062	3/17	A9A15922	7/9	A9C18309	7/9	A9C22012	7/4
27145	3/16	A9A15923	7/9	A9C20132	7/4	A9C22015	7/4
29370	8/17	A9A26476	2/21	A9C20134	7/4	A9C22111	7/4
29450	8/18	A9A26477	2/21	A9C20137	7/4	A9C22112	7/4
29451	8/18	A9A26478	2/21	A9C20162	7/4	A9C22114	7/4
29457	8/17	A9A26500	2/21	A9C20164	7/4	A9C22115	7/4
29458	8/17	A9A26869	2/22	A9C20167	7/4	A9C22415	7/4
33489	8/7	A9A26897	2/22	A9C20232	7/4	A9C22511	7/4
33489	8/9	A9A26924	2/22	A9C20531	7/4	A9C22512	7/4
33490	8/7	A9A26927	2/22	A9C20532	7/4	A9C22515	7/4
33490	8/9	A9A26929	2/22	A9C20536	7/4	A9C22615	7/4
33494	8/7	A9A26946	2/21	A9C20631	7/4	A9C22711	7/4
33495	8/7	A9A26947	2/21	A9C20632	7/4	A9C22712	7/4
33564	8/7	A9A26948	2/21	A9C20633	7/4	A9C22715	7/4
33564	8/9	A9A26959	2/20	A9C20636	7/4	A9C22722	7/4

Product list

Reference	Page	Reference	Page	Reference	Page	Reference	Page
A9C22813	7/4	A9C66316	6/2	A9D19810	2/5	A9E18033	7/30
A9C22814	7/4	A9C66325	6/2	A9D19816	2/5	A9E18034	7/30
A9C22818	7/4	A9C66410	6/2	A9D19820	2/5	A9E18035	7/30
A9C22824	7/4	A9C66416	6/2	A9D19825	2/5	A9E18036	7/30
A9C23512	7/5	A9C66425	6/2	A9D19832	2/5	A9E18037	7/30
A9C23515	7/5	A9C70112	6/12	A9D31606	3/5	A9E18038	7/30
A9C23712	7/5	A9C70114	6/12	A9D31610	3/5	A9E18039	7/30
A9C23715	7/5	A9C70122	6/7	A9D31616	3/5	A9E18070	7/38
A9C30011	7/18	A9C70122	6/12	A9D31620	3/5	A9E18070	7/38
A9C30012	7/18	A9C70124	6/7	A9D31625	3/5	A9E18071	7/38
A9C30015	7/18	A9C70124	6/12	A9D31632	3/5	A9E18072	7/38
A9C30111	7/18	A9C70132	6/7	A9D31640	3/5	A9E18073	7/38
A9C30112	7/18	A9C70134	6/7	A9D31806	2/5	A9E18074	7/38
A9C30114	7/18	A9C70342	6/7	A9D31810	2/5	A9E18320	7/29
A9C30115	7/18	A9C70344	6/7	A9D31816	2/5	A9E18321	7/29
A9C30211	7/18	A9D01610	3/5	A9D31820	2/5	A9E18322	7/29
A9C30212	7/18	A9D01616	3/5	A9D31825	2/5	A9E18323	7/29
A9C30215	7/18	A9D01620	3/5	A9D31832	2/5	A9E18324	7/29
A9C30311	7/18	A9D06610	3/5	A9D31840	2/5	A9E18325	7/29
A9C30312	7/18	A9D06616	3/5	A9D31845	2/5	A9E18326	7/29
A9C30315	7/18	A9D06620	3/5	A9D51210	2/6	A9E18327	7/29
A9C30811	7/18	A9D10806	2/5	A9D51216	2/6	A9E18328	7/29
A9C30812	7/18	A9D10810	2/5	A9D51220	2/6	A9E18330	7/29
A9C30814	7/18	A9D10816	2/5	A9D51225	2/6	A9E18331	7/29
A9C30815	7/18	A9D10820	2/5	A9D51232	2/6	A9E18332	7/29
A9C30831	7/18	A9D10825	2/5	A9D55604	3/5	A9E18333	7/29
A9C32016	7/18	A9D10832	2/5	A9D55606	3/5	A9E18334	7/29
A9C32111	7/18	A9D10840	2/5	A9D55610	3/5	A9E18335	7/29
A9C32116	7/18	A9D10845	2/5	A9D55616	3/5	A9E21180	7/59
A9C32211	7/18	A9D11210	2/6	A9D55620	3/5	A9E21181	7/59
A9C32216	7/18	A9D11216	2/6	A9D55625	3/5	A9E21182	7/59
A9C32316	7/18	A9D11220	2/6	A9D55632	3/5	A9E21183	7/59
A9C32811	7/18	A9D11225	2/6	A9D55640	3/5	A9E21183	7/59
A9C32816	7/18	A9D11232	2/6	A9E15120	7/48	A9F53101	2/2
A9C32836	7/18	A9D11806	2/5	A9E15120	7/48	A9F53102	2/2
A9C33111	7/19	A9D11810	2/5	A9E15121	7/48	A9F53103	2/2
A9C33211	7/19	A9D11816	2/5	A9E15122	7/48	A9F53104	2/2
A9C33811	7/19	A9D11820	2/5	A9E15123	7/48	A9F53106	2/2
A9C34811	7/19	A9D11825	2/5	A9E15535	7/57	A9F53110	2/2
A9C65210	6/2	A9D11832	2/5	A9E15536	7/57	A9F53116	2/2
A9C65216	6/2	A9D11840	2/5	A9E15537	7/57	A9F53120	2/2
A9C65225	6/2	A9D11845	2/5	A9E15538	7/57	A9F53125	2/2
A9C65240	6/2	A9D12806	2/5	A9E15539	7/57	A9F53132	2/2
A9C65310	6/2	A9D12810	2/5	A9E15540	7/57	A9F53140	2/2
A9C65316	6/2	A9D12816	2/5	A9E15541	7/57	A9F53150	2/2
A9C65325	6/2	A9D12820	2/5	A9E15542	7/57	A9F53163	2/2
A9C65340	6/2	A9D12825	2/5	A9E16065	7/54	A9F53201	2/2
A9C65410	6/2	A9D12832	2/5	A9E16066	7/54	A9F53202	2/2
A9C65416	6/2	A9D12840	2/5	A9E16067	7/54	A9F53204	2/2
A9C65425	6/2	A9D12845	2/5	A9E16068	7/55	A9F53206	2/2
A9C65440	6/2	A9D19210	2/6	A9E16069	7/55	A9F53210	2/2
A9C66210	6/2	A9D19216	2/6	A9E16070	7/55	A9F53216	2/2
A9C66216	6/2	A9D19220	2/6	A9E18030	7/30	A9F53220	2/2
A9C66225	6/2	A9D19225	2/6	A9E18031	7/30	A9F53225	2/2
A9C66310	6/2	A9D19232	2/6	A9E18032	7/30	A9F53232	2/2

Product list

Reference	Page	Reference	Page	Reference	Page	Reference	Page
A9F53240	2/2	A9F54310	2/3	A9F55363	2/3	A9MEM3110	7/88
A9F53250	2/2	A9F54316	2/3	A9F55401	2/3	A9MEM3110	7/90
A9F53263	2/2	A9F54320	2/3	A9F55402	2/3	A9MEM3115	7/88
A9F53301	2/3	A9F54325	2/3	A9F55404	2/3	A9MEM3115	7/90
A9F53302	2/3	A9F54332	2/3	A9F55406	2/3	A9MEM3135	7/88
A9F53304	2/3	A9F54340	2/3	A9F55410	2/3	A9MEM3150	7/88
A9F53306	2/3	A9F54350	2/3	A9F55416	2/3	A9MEM3150	7/90
A9F53310	2/3	A9F54363	2/3	A9F55420	2/3	A9MEM3155	7/88
A9F53316	2/3	A9F54401	2/3	A9F55425	2/3	A9MEM3155	7/90
A9F53320	2/3	A9F54402	2/3	A9F55432	2/3	A9MEM3200	7/90
A9F53325	2/3	A9F54404	2/3	A9F55440	2/3	A9MEM3210	7/90
A9F53332	2/3	A9F54406	2/3	A9F55450	2/3	A9MEM3215	7/90
A9F53340	2/3	A9F54410	2/3	A9F55463	2/3	A9MEM3235	7/90
A9F53350	2/3	A9F54416	2/3	A9L00002	4/9	A9MEM3250	7/90
A9F53363	2/3	A9F54420	2/3	A9L08102	4/9	A9MEM3255	7/90
A9F53401	2/3	A9F54425	2/3	A9L08500	4/8	A9N15635	7/43
A9F53402	2/3	A9F54432	2/3	A9L08501	4/8	A9N15636	7/43
A9F53404	2/3	A9F54440	2/3	A9L08600	4/8	A9N15645	7/43
A9F53406	2/3	A9F54450	2/3	A9L08601	4/8	A9N15646	7/43
A9F53410	2/3	A9F54463	2/3	A9L16292	4/12	A9N15650	7/43
A9F53416	2/3	A9F55101	2/2	A9L16294	4/12	A9N15651	7/43
A9F53420	2/3	A9F55102	2/2	A9L16295	4/12	A9N15655	7/43
A9F53425	2/3	A9F55104	2/2	A9L16297	4/12	A9N15656	7/43
A9F53432	2/3	A9F55106	2/2	A9L16298	4/12	A9N15657	7/43
A9F53440	2/3	A9F55110	2/2	A9L16300	4/12	A9N15658	7/43
A9F53450	2/3	A9F55116	2/2	A9L16310	4/12	A9N17515	3/2
A9F53463	2/3	A9F55120	2/2	A9L16311	4/12	A9N17516	3/2
A9F54101	2/2	A9F55125	2/2	A9L16312	4/12	A9N17517	3/2
A9F54102	2/2	A9F55132	2/2	A9L16313	4/12	A9N17518	3/2
A9F54104	2/2	A9F55140	2/2	A9L16434	4/15	A9N17519	3/2
A9F54106	2/2	A9F55150	2/2	A9L16436	4/15	A9N17520	3/2
A9F54110	2/2	A9F55163	2/2	A9L16632	4/2	A9N17521	3/2
A9F54116	2/2	A9F55201	2/2	A9L16634	4/2	A9N17522	3/2
A9F54120	2/2	A9F55202	2/2	A9L16683	4/15	A9N17523	3/2
A9F54125	2/2	A9F55204	2/2	A9L16690	4/15	A9N18401	3/8
A9F54132	2/2	A9F55206	2/2	A9L16692	4/15	A9N18402	3/8
A9F54140	2/2	A9F55210	2/2	A9L20500	4/8	A9N18403	3/8
A9F54150	2/2	A9F55216	2/2	A9L20501	4/8	A9N18404	3/8
A9F54163	2/2	A9F55220	2/2	A9L21102	4/9	A9N18412	3/8
A9F54201	2/2	A9F55225	2/2	A9L40102	4/9	A9N18413	3/8
A9F54202	2/2	A9F55232	2/2	A9L40500	4/8	A9N18414	3/8
A9F54204	2/2	A9F55240	2/2	A9L40501	4/8	A9N18415	3/8
A9F54206	2/2	A9F55250	2/2	A9L40600	4/8	A9N18423	3/9
A9F54210	2/2	A9F55263	2/2	A9L40601	4/8	A9N18424	3/9
A9F54216	2/2	A9F55301	2/3	A9L65102	4/9	A9N18425	3/9
A9F54220	2/2	A9F55302	2/3	A9L65501	4/8	A9N18426	3/9
A9F54225	2/2	A9F55304	2/3	A9L65601	4/8	A9N18434	3/9
A9F54232	2/2	A9F55306	2/3	A9M17065	7/88	A9N18435	3/9
A9F54240	2/2	A9F55310	2/3	A9M17066	7/88	A9N18436	3/9
A9F54250	2/2	A9F55316	2/3	A9M17067	7/88	A9N18437	3/9
A9F54263	2/2	A9F55320	2/3	A9MEM2000	7/88	A9N18445	3/9
A9F54301	2/3	A9F55325	2/3	A9MEM2000T	7/88	A9N18446	3/9
A9F54302	2/3	A9F55332	2/3	A9MEM2010	7/88	A9N18447	3/9
A9F54304	2/3	A9F55340	2/3	A9MEM3100	7/88	A9N18448	3/9
A9F54306	2/3	A9F55350	2/3	A9MEM3100	7/90	A9N18456	3/8

Product list

Reference	Page	Reference	Page	Reference	Page	Reference	Page
A9N18457	3/8	A9N18577	3/12	A9R21480	2/13	A9S61232	7/35
A9N18458	3/8	A9N18578	3/12	A9R21491	2/13	A9S66140	7/31
A9N18459	3/8	A9N18579	3/12	A9R22440	2/13	A9S66163	7/31
A9N18467	3/9	A9N18580	3/12	A9R22463	2/13	A9S66191	7/31
A9N18468	3/9	A9N18587	3/12	A9R24225	2/13	A9S66192	7/31
A9N18469	3/9	A9N18588	3/12	A9R24240	2/13	A9S66240	7/31
A9N18470	3/9	A9N18589	3/12	A9R24263	2/13	A9S66263	7/31
A9N18478	3/9	A9N18591	3/13	A9R24291	2/13	A9S66291	7/31
A9N18479	3/9	A9N18592	3/13	A9R24425	2/13	A9S66292	7/31
A9N18480	3/9	A9N18594	3/13	A9R24440	2/13	A9S66340	7/31
A9N18481	3/9	A9N18595	3/13	A9R24463	2/13	A9S66363	7/31
A9N18489	3/8	A9N18597	3/13	A9R24480	2/13	A9S66391	7/31
A9N18490	3/8	A9N18598	3/13	A9R24491	2/13	A9S66392	7/31
A9N18491	3/8	A9N18599	3/13	A9R25240	2/13	A9S66440	7/31
A9N18492	3/8	A9N21552	3/2	A9R25263	2/13	A9S66463	7/31
A9N18500	3/8	A9N21553	3/2	A9R25291	2/13	A9S66491	7/31
A9N18501	3/8	A9N21554	3/2	A9R25440	2/13	A9S66492	7/31
A9N18502	3/8	A9N21555	3/2	A9R25463	2/13	A9V02663	2/9
A9N18503	3/8	A9N21556	3/2	A9R25480	2/13	A9V02763	2/9
A9N18511	3/9	A9N21557	3/2	A9R25491	2/13	A9V03663	2/9
A9N18512	3/9	A9N21558	3/2	A9R26440	2/13	A9V04263	2/9
A9N18513	3/9	A9N21559	3/2	A9R26463	2/13	A9V06663	2/9
A9N18514	3/9	A9N21560	3/2	A9R26491	2/13	A9V06763	2/9
A9N18522	3/9	A9N21561	3/2	A9R30225	2/14	A9V22225	2/10
A9N18523	3/9	A9N21722	3/2	A9R31480	2/14	A9V22225	2/10
A9N18524	3/9	A9N26476	3/21	A9R31491	2/14	A9V22263	2/10
A9N18525	3/9	A9N26477	3/21	A9R34463	2/14	A9V22263	2/10
A9N18544	3/11	A9N26478	3/21	A9R35240	2/14	A9V22325	2/10
A9N18545	3/11	A9N26500	3/21	A9R35263	2/14	A9V22425	2/10
A9N18546	3/11	A9N26899	3/22	A9R35291	2/14	A9V22463	2/10
A9N18547	3/11	A9N26923	3/22	A9R35440	2/14	A9V25263	2/10
A9N18548	3/11	A9N26924	3/22	A9R35463	2/14	A9V25263	2/10
A9N18549	3/11	A9N26927	3/22	A9R35480	2/14	A9V25363	2/10
A9N18554	3/13	A9N26929	3/22	A9R35491	2/14	A9V25463	2/10
A9N18555	3/13	A9N26946	3/21	A9R37440	2/14	A9V26225	2/10
A9N18556	3/13	A9N26947	3/21	A9R37463	2/14	A9V26225	2/10
A9N18557	3/13	A9N26948	3/21	A9R37480	2/14	A9V26263	2/10
A9N18558	3/13	A9N26959	3/20	A9R61225	2/14	A9V26263	2/10
A9N18559	3/13	A9N26960	3/20	A9R61240	2/14	A9V26325	2/10
A9N18560	3/13	A9N26961	3/20	A9R61263	2/14	A9V26363	2/10
A9N18561	3/13	A9N26963	3/20	A9R61425	2/14	A9V26425	2/10
A9N18563	3/11	A9N26969	3/20	A9R61440	2/14	A9V26463	2/10
A9N18564	3/11	A9N26971	3/20	A9R61463	2/14	A9V29263	2/10
A9N18565	3/11	A9N27062	3/17	A9S60120	7/34	A9V29263	2/10
A9N18566	3/11	A9R08263	2/13	A9S60132	7/34	A9V29363	2/10
A9N18567	3/11	A9R08463	2/13	A9S60220	7/34	A9V29463	2/10
A9N18568	3/11	A9R20216	2/13	A9S60232	7/34	A9V30225	2/11
A9N18569	3/11	A9R20225	2/13	A9S60292	7/34	A9V30225	2/11
A9N18570	3/11	A9R21225	2/13	A9S60320	7/34	A9V39263	2/11
A9N18571	3/11	A9R21240	2/13	A9S60332	7/34	A9V39363	2/11
A9N18572	3/12	A9R21263	2/13	A9S60420	7/34	A9V39463	2/11
A9N18573	3/12	A9R21291	2/13	A9S60432	7/34	A9V51225	2/10
A9N18574	3/12	A9R21425	2/13	A9S61120	7/35	A9V51263	2/10
A9N18575	3/12	A9R21440	2/13	A9S61132	7/35	A9V51325	2/10
A9N18576	3/12	A9R21463	2/13	A9S61220	7/35	A9V51363	2/10

Product list

Reference	Page	Reference	Page	Reference	Page	Reference	Page
A9V51425	2/10	A9XPH424	10/2	CCT15722	7/70	DF2EA40	7/46
A9V51463	2/10	A9XPH457	10/2	CCT15723	7/70	DF2EA50	7/46
A9V54225	2/10	A9XPM112	10/3	CCT15723	7/70	DF2EN10	7/46
A9V54263	2/10	A9XPM212	10/3	CCT15837	7/71	DF2EN16	7/46
A9V54325	2/10	A9XPM312	10/3	CCT15838	7/71	DF2EN20	7/46
A9V54363	2/10	A9XPM412	10/3	CCT15840	7/69	DF2EN25	7/46
A9V54425	2/10	A9XPM512	10/3	CCT15854	7/71	DF2EN32	7/46
A9V54463	2/10	A9XPT920	10/2	CCT15854	7/71	DF2EN40	7/46
A9V61225	2/11	CCT15223	7/83	CCT15860	7/74	DF2EN50	7/46
A9V61240	2/11	CCT15224	7/83	CCT15860	7/74	DF2FA100	7/46
A9V61263	2/11	CCT15224	7/83	CCT15860	7/84	DF2FA125	7/46
A9V61325	2/11	CCT15232	7/62	CCT15861	7/74	DF2FA32	7/46
A9V61325	2/11	CCT15232	7/69	CCT15861	7/74	DF2FA40	7/46
A9V61340	2/11	CCT15233	7/69	CCT15861	7/84	DF2FA50	7/46
A9V61363	2/11	CCT15233	7/63	CCT15910	7/71	DF2FA63	7/46
A9V61425	2/11	CCT15234	7/69	CCT15910	7/71	DF2FA80	7/46
A9V61440	2/11	CCT15234	7/63	CCT15940	7/71	DF2FN100	7/46
A9V61463	2/11	CCT15243	7/83	CCT15940	7/71	DF2FN32	7/46
A9V65263	2/11	CCT15244	7/83	CCT15950	7/69	DF2FN40	7/46
A9V65363	2/11	CCT15244	7/83	CCT15950	7/74	DF2FN50	7/46
A9V65463	2/11	CCT15251	7/83	CCT15955	7/74	DF2FN63	7/46
A9XAH157	10/2	CCT15251	7/69	CCT15955	7/74	DF2FN80	7/46
A9XAH257	10/2	CCT15253	7/83	CCT15970	7/75	LGY112510	10/6
A9XAH357	10/2	CCT15253	7/69	CCT16364	7/72	LGY116013	10/6
A9XAH457	10/2	CCT15260	7/83	CCT16364	7/72	LGY125014	10/6
A9XAH557	10/2	CCT15260	7/84	DF2BA0200	7/43	LGY410028	10/6
A9XAH657	10/2	CCT15261	7/84	DF2BA0400	7/43	LGY412548	10/7
A9XC2412	6/16	CCT15261	7/83	DF2BA0600	7/43	LGY412560	10/7
A9XCAL06	6/16	CCT15268	7/82	DF2BA0800	7/43	LGY416048	10/7
A9XCAM06	6/16	CCT15268	7/84	DF2BA1000	7/43	LGYN1007	10/7
A9XCAS06	6/16	CCT15284	7/82	DF2BN0200	7/43	LGYN12515	10/7
A9XCATM1	6/16	CCT15284	7/82	DF2BN0400	7/43	LIN001	7/44
A9XCAU06	6/16	CCT15338	7/72	DF2BN0600	7/43	LV429211	8/17
A9XM2B04	6/16	CCT15338	7/69	DF2BN0800	7/43	LV429242	8/18
A9XMMEA08	6/16	CCT15338	7/72	DF2BN1000	7/43	LV429243	8/18
A9XMFA04	6/16	CCT15365	7/72	DF2CA02	7/43	LV429252	8/18
A9XMLA02	6/16	CCT15365	7/69	DF2CA04	7/43	LV429253	8/18
A9XMSB11	6/16	CCT15365	7/72	DF2CA06	7/43	LV429254	8/18
A9XPCD04	10/2	CCT15367	7/73	DF2CA10	7/43	LV429256	8/18
A9XPCM04	10/2	CCT15367	7/69	DF2CA16	7/43	LV429257	8/18
A9XPE110	10/2	CCT15367	7/73	DF2CA20	7/43	LV429258	8/18
A9XPE210	10/2	CCT15368	7/82	DF2CA25	7/43	LV429259	8/18
A9XPE310	10/2	CCT15368	7/82	DF2CN02	7/43	LV429260	8/18
A9XPE410	10/2	CCT15483	7/82	DF2CN04	7/43	LV429320	8/18
A9XPH106	10/2	CCT15490	7/83	DF2CN06	7/43	LV429337	8/17
A9XPH112	10/2	CCT15491	7/83	DF2CN10	7/43	LV429339	8/17
A9XPH124	10/2	CCT15491	7/83	DF2CN16	7/43	LV429371	8/17
A9XPH157	10/2	CCT15493	7/83	DF2CN20	7/43	LV429387	8/18
A9XPH212	10/2	CCT15493	7/83	DF2CN25	7/43	LV429388	8/18
A9XPH224	10/2	CCT15494	7/83	DF2EA10	7/46	LV429407	8/18
A9XPH257	10/2	CCT15720	7/70	DF2EA12	7/46	LV429408	8/18
A9XPH312	10/2	CCT15720	7/70	DF2EA16	7/46	LV429461	8/21
A9XPH324	10/2	CCT15721	7/70	DF2EA20	7/46	LV429461	8/17
A9XPH357	10/2	CCT15721	7/70	DF2EA25	7/46	LV429462	8/17
A9XPH412	10/2	CCT15722	7/70	DF2EA32	7/46	LV429462	8/21

Product list

Reference	Page	Reference	Page	Reference	Page	Reference	Page
LV429504	8/18	METSECT5CC005	7/102	METSECT5MD050	7/102	MG6PAC24	10/11
LV429505	8/18	METSECT5CC006	7/102	METSECT5MD060	7/102	MG6PAC30	10/11
LV429506	8/18	METSECT5CC008	7/102	METSECT5MD080	7/102	MG6PAC6	10/11
LV429507	8/18	METSECT5CC010	7/102	METSECT5ME015	7/102	MG6PACN	10/11
LV429517	8/18	METSECT5CC013	7/102	METSECT5ME020	7/102	MG6PACN	10/11
LV429518	8/18	METSECT5CC015	7/102	METSECT5ME025	7/102	MG6PAFC12	10/11
LV430557	8/17	METSECT5CC020	7/102	METSECT5ME030	7/102	MG6PAFC12	10/11
LV430558	8/17	METSECT5CC025	7/102	METSECT5ME040	7/102	MG6PAFC18	10/11
LV430561	8/21	METSECT5COVER	7/103	METSECT5ME050	7/102	MG6PAFC18	10/11
LV430561	8/17	METSECT5CYL1	7/103	METSECT5ME060	7/102	MG6PAFC6	10/11
LV430562	8/17	METSECT5CYL2	7/103	METSECT5MF025	7/102	MG6PAFC6	10/11
LV430562	8/21	METSECT5DA020	7/104	METSECT5MF030	7/102	MG6PANKIT	10/11
LV431536	8/17	METSECT5DA025	7/104	METSECT5MF040	7/102	MG88M	8/20
LV431563	8/18	METSECT5DA030	7/104	METSECT5MF050	7/102	MG88MX	8/20
LV431564	8/18	METSECT5DA040	7/104	METSECT5VF050	7/104	MG8C12	8/6
LV431567	8/17	METSECT5DA050	7/104	METSECT5VF060	7/104	MG8C12T	8/8
LV431568	8/17	METSECT5DA060	7/104	METSECT5VV500	7/104	MG8C18	8/6
LV431569	8/21	METSECT5DA080	7/104	METSECT5VV600	7/104	MG8C18T	8/8
LV431569	8/17	METSECT5DA100	7/104	METSEPM3200	7/93	MG8C6	8/6
LV431570	8/17	METSECT5DA125	7/104	METSEPM3210	7/93	MG8C6T	8/8
LV431570	8/21	METSECT5DA150	7/104	METSEPM3250	7/93	MG8FCC12	8/16
LV432456	8/17	METSECT5DB100	7/104	METSEPM3255	7/93	MG8FCC18	8/16
LV432479	8/18	METSECT5DB125	7/104	MG16C14	8/6	MG8FCC6	8/16
LV432480	8/18	METSECT5DB150	7/104	MG16C14T	8/8	MG8PAC12	10/11
LV432481	8/18	METSECT5DB200	7/104	MG16CE14	8/6	MG8PAC18	10/11
LV432482	8/18	METSECT5DB250	7/104	MG16CE14T	8/8	MG8PAC24	10/11
LV432490	8/18	METSECT5DB300	7/104	MG16CEM4	8/21	MG8PAC30	10/11
LV432491	8/18	METSECT5DC200	7/104	MG16CEX4	8/15	MG8PAC6	10/11
LV432500	8/18	METSECT5DC250	7/104	MG25C2	8/6	MG8PACN3	10/11
LV432501	8/18	METSECT5DC300	7/104	MG25C2M	8/6	MG8PACN4	10/11
LV432502	8/18	METSECT5DC400	7/104	MG25C2M	8/20	MG8PANKIT	10/11
LV432503	8/18	METSECT5DD100	7/104	MG25C4	8/6	MGBL	10/12
LV432504	8/18	METSECT5DD125	7/104	MG25C4M	8/6	MGE0404M5	9/4
LV432505	8/18	METSECT5DD150	7/104	MG25C4M	8/20	MGE0632X	9/2
LV432506	8/18	METSECT5DE100	7/104	MG25EXC	8/15	MGE0633X	9/2
LV432507	8/18	METSECT5DE125	7/104	MG25FCC2	8/16	MGE0634X	9/2
LV432593	8/18	METSECT5DE150	7/104	MG25FCC2M	8/16	MGE0634XE	9/2
LV432597	8/17	METSECT5DE200	7/104	MG25FCC4	8/16	MGE1002X	9/2
LV432599	8/17	METSECT5DH125	7/104	MG25FCC4M	8/16	MGE1003X	9/2
LV432631	8/17	METSECT5DH150	7/104	MG2C13	8/6	MGE1003XS	9/3
LV432631	8/17	METSECT5DH200	7/104	MG2C5	8/6	MGE1004M5	9/4
LV432653	8/21	METSECT5MA015	7/102	MG2C7	8/6	MGE1004X	9/2
LV432653	8/17	METSECT5MA020	7/102	MG2C9	8/6	MGE1004XE	9/2
LV432654	8/17	METSECT5MA025	7/102	MG64M	8/20	MGE1004XS	9/3
LV432654	8/21	METSECT5MA030	7/102	MG66M	8/20	MGE1004XSE	9/3
LV432657	8/17	METSECT5MA040	7/102	MG6C12	8/6	MGE1252X	9/2
LV432658	8/17	METSECT5MB025	7/102	MG6C18	8/6	MGE1253X	9/2
LV432857	8/17	METSECT5MB030	7/102	MG6C6	8/6	MGE1254X	9/2
LV432858	8/17	METSECT5MB040	7/102	MG6CEX	8/15	MGE1254XE	9/2
LV432861	8/21	METSECT5MC025	7/102	MG6CEXM	8/20	MGE1602X	9/2
LV432861	8/17	METSECT5MC030	7/102	MG6FCC12	8/16	MGE1603X	9/2
LV432862	8/17	METSECT5MC040	7/102	MG6FCC18	8/16	MGE1603XS	9/3
LV432862	8/21	METSECT5MC050	7/102	MG6FCC6	8/16	MGE1604M5	9/4
LV434205	8/28	METSECT5MC060	7/102	MG6PAC12	10/11	MGE1604X	9/2
METSECT5CC004	7/102	METSECT5MC080	7/102	MG6PAC18	10/11	MGE1604XE	9/2

Product list

Reference	Page	Reference	Page	Reference	Page	Reference	Page
MGE1604XS	9/3	MGFC400	9/9	MGN15715	7/46	MGP0403X	8/11
MGE1604XSE	9/3	MGFC630	9/9	MGN15716	7/46	MGP0403XE2	8/12
MGE2003X	9/2	MGFD1003C	9/8	MGN15717	7/46	MGP0403XE2N	8/12
MGE2004X	9/2	MGFD1603C	9/8	MGN15718	7/46	MGP0403XN	8/12
MGE2004XE	9/2	MGFD2503C	9/8	MGP0161L1	8/10	MGP0404X	8/11
MGE2503X	9/2	MGFD4003C	9/8	MGP0161L2	8/10	MGP0404XE2	8/12
MGE2503XS	9/3	MGFJ400	9/9	MGP0161L3	8/10	MGP0404XE2N	8/12
MGE2504M5	9/4	MGFJ630	9/9	MGP0162L12	8/10	MGP0404XN	8/12
MGE2504X	9/2	MGFK200	9/9	MGP0162L1N	8/10	MGP0501L1	8/10
MGE2504XE	9/2	MGFK400	9/9	MGP0162L23	8/10	MGP0501L2	8/10
MGE2504XS	9/3	MGFK630	9/9	MGP0162L2N	8/10	MGP0501L3	8/10
MGE2504XSE	9/3	MGFL0201C	9/7	MGP0162L31	8/10	MGP0502L1N	8/10
MGE4003X	9/2	MGFL0203C	9/7	MGP0162L3N	8/10	MGP0502L2N	8/10
MGE4003XS	9/3	MGFL0321C	9/7	MGP0163X	8/11	MGP0502L3N	8/10
MGE4004M5	9/4	MGFL0323C	9/7	MGP0163XN	8/12	MGP0503X	8/11
MGE4004X	9/2	MGFL0631C	9/7	MGP0164X	8/11	MGP0503XN	8/12
MGE4004XE	9/2	MGFL0633C	9/7	MGP0164XN	8/12	MGP0504XN	8/12
MGE4004XS	9/3	MGFL1001C	9/7	MGP0201L1	8/10	MGP0631L1	8/10
MGE4004XSE	9/3	MGFL1003C	9/7	MGP0201L2	8/10	MGP0631L2	8/10
MGE6303X	9/2	MGFQ100	9/8	MGP0201L3	8/10	MGP0631L3	8/10
MGE6303XS	9/3	MGFQ160	9/8	MGP0251L1	8/10	MGP0632L12	8/10
MGE6304M5	9/4	MGFQ250	9/8	MGP0251L2	8/10	MGP0632L1N	8/10
MGE6304X	9/2	MGFQ250	9/8	MGP0251L3	8/10	MGP0632L23	8/10
MGE6304XE	9/2	MGFQ400	9/8	MGP0252L12	8/10	MGP0632L2N	8/10
MGE6304XS	9/3	MGFQ400	9/8	MGP0252L1N	8/10	MGP0632L31	8/10
MGE6304XSE	9/3	MGFQ630	9/8	MGP0252L23	8/10	MGP0632L3N	8/10
MGES063	9/6	MGFQ630	9/8	MGP0252L2N	8/10	MGP0633X	8/11
MGES063R	9/6	MGFS1003C	9/8	MGP0252L31	8/10	MGP0633XN	8/12
MGES100R	9/6	MGFS1603C	9/8	MGP0252L3N	8/10	MGP0634X	8/11
MGES160R	9/6	MGFS2003C	9/8	MGP0253X	8/11	MGP0634XN	8/12
MGES250R	9/6	MGFS2503C	9/8	MGP0253XN	8/12	MGP0801L1	8/10
MGES320R	9/6	MGFS3153C	9/8	MGP0254X	8/11	MGP0801L2	8/10
MGES400R	9/6	MGFS4003C	9/8	MGP0254XN	8/12	MGP0801L3	8/10
MGES500	9/6	MGFS5003C	9/8	MGP0301L1	8/10	MGP0802L12	8/10
MGES500R	9/6	MGFS6303C	9/8	MGP0301L2	8/10	MGP0802L1N	8/10
MGES630	9/6	MGFX100C	9/8	MGP0301L3	8/10	MGP0802L23	8/10
MGES630R	9/6	MGFX160C	9/8	MGP0302L12	8/10	MGP0802L2N	8/10
MGFA0201C	9/7	MGFX250C	9/8	MGP0302L1N	8/10	MGP0802L31	8/10
MGFA0203C	9/7	MGFX250C	9/8	MGP0302L23	8/10	MGP0802L3N	8/10
MGFA0321C	9/7	MGFX500C	9/8	MGP0302L2N	8/10	MGP0803X	8/11
MGFA0323C	9/7	MGFZ160	9/9	MGP0302L31	8/10	MGP0803XN	8/12
MGFA0631C	9/7	MGFZ160	9/9	MGP0302L3N	8/10	MGP0804X	8/11
MGFA0633C	9/7	MGFZ250	9/9	MGP0323X	8/11	MGP0804XN	8/12
MGFA1001C	9/7	MGFZ250	9/9	MGP0323XN	8/12	MGP1001L1	8/10
MGFA1003C	9/7	MGFZ630	9/9	MGP0324X	8/11	MGP1001L2	8/10
MGFB20007C	9/9	MGFZ630T	9/9	MGP0324XN	8/12	MGP1001L3	8/10
MGFB20012C	9/9	MGK33	8/16	MGP0401L1	8/10	MGP1002L12	8/10
MGFB20018C	9/9	MGN15707	7/46	MGP0401L2	8/10	MGP1002L1N	8/10
MGFB40007C	9/9	MGN15708	7/46	MGP0401L3	8/10	MGP1002L23	8/10
MGFB40012C	9/9	MGN15709	7/46	MGP0402L12	8/10	MGP1002L2N	8/10
MGFB40018C	9/9	MGN15710	7/46	MGP0402L1N	8/10	MGP1002L31	8/10
MGFB63007C	9/9	MGN15711	7/46	MGP0402L23	8/10	MGP1002L3N	8/10
MGFB63012C	9/9	MGN15712	7/46	MGP0402L2N	8/10	MGP1003NAX	8/7
MGFB63018C	9/9	MGN15713	7/46	MGP0402L31	8/10	MGP1003TX	8/9
MGFC200	9/9	MGN15714	7/46	MGP0402L3N	8/10	MGP1003X	8/7

Product list

Reference	Page	Reference	Page	Reference	Page	Reference	Page
MGP1003X	8/11	MGP2503X	8/7	MGPCIN	8/7	PRA20224	10/15
MGP1003XE2	8/12	MGP2503X	8/11	MGPCM12L	8/20	PRA20313	10/15
MGP1003XE2N	8/12	MGP2503XE2	8/12	MGPCM12R	8/20	PRA20324	10/15
MGP1003XN	8/12	MGP2503XE2N	8/12	MGPCM18L	8/20	PRA20413	10/15
MGP1004NAX	8/7	MGP2503XN	8/12	MGPCM18R	8/20	PRA20424	10/15
MGP1004TX	8/9	MGP2504LL	8/7	MGPCM6L	8/20	PRA90009	10/15
MGP1004X	8/7	MGP2504NAX	8/7	MGPCM6R	8/20	PRA90039	10/15
MGP1004X	8/11	MGP2504TX	8/9	MGPCML	8/20	PRA91020	10/15
MGP1004XE2	8/12	MGP2504X	8/7	MGPCML	8/20	PRD1PN20R	4/18
MGP1004XE2N	8/12	MGP2504X	8/11	MGPGPC8	8/16	PRD1PN40	4/18
MGP1004XN	8/12	MGP2504XE2	8/12	MGPP4S007	8/16	PRD1PN40R	4/18
MGP1251L1	8/10	MGP2504XE2N	8/12	MGPXC206	8/15	PRD1PN8	4/18
MGP1251L2	8/10	MGP2504XN	8/12	MGPXC212	8/15	PRD3PN40	4/18
MGP1251L3	8/10	MGP250NL	8/7	MGPXC218	8/15	PRD3PN40R	4/18
MGP1252L12	8/10	MGP250NL	8/11	MGPXC506	8/15	PRD3PN65R	4/18
MGP1252L1N	8/10	MGP4003NATX	8/9	MGPXC512	8/15	PRD3PN8	4/18
MGP1252L23	8/10	MGP4003NAX	8/7	MGPXC518	8/15	SE9LA	2/25
MGP1252L2N	8/10	MGP4003TX	8/9	MIP12104	10/17	SEA91252	1/6
MGP1252L31	8/10	MGP4003X	8/7	MIP12106	10/17	SEA91253N	1/12
MGP1252L3N	8/10	MGP4003X	8/11	MIP12108	10/17	SEA91254	1/12
MGP1253X	8/11	MGP4003X5E	8/12	MIP12112	10/17	SEA9125SPEV	1/12
MGP1253XN	8/12	MGP4004NAX	8/7	MIP12118	10/17	SEA9250SPEV	1/13
MGP1254X	8/11	MGP4004TX	8/9	MIP12212	10/17	SEA9AN10	1/4
MGP1254XN	8/12	MGP4004X	8/7	MIP12312	10/17	SEA9AN1016MS	1/4
MGP1601L1	8/10	MGP4004X	8/11	MIP99029	10/17	SEA9AN106DS	1/5
MGP1601L2	8/10	MGP4004X5E	8/12	MIP99030	10/17	SEA9AN108MS	1/4
MGP1601L3	8/10	MGP6303NATX	8/9	MIP99031	10/17	SEA9AN10C	1/7
MGP1602L12	8/10	MGP6303NAX	8/7	MIP99032	10/17	SEA9AN10FK	1/7
MGP1602L1N	8/10	MGP6303TX	8/9	MIP99033	10/17	SEA9AN10PS	1/7
MGP1602L23	8/10	MGP6303X	8/7	MIP99034	10/17	SEA9AN10S10	1/5
MGP1602L2N	8/10	MGP6303X	8/11	MIP99036	10/17	SEA9AN14	1/4
MGP1602L31	8/10	MGP6303X	8/11	MIP99037	10/17	SEA9AN1432MS	1/4
MGP1602L3N	8/10	MGP6304NAX	8/7	MIP99038	10/17	SEA9AN148MS	1/4
MGP1603NAX	8/7	MGP6304TX	8/9	MIP99039	10/17	SEA9AN14C	1/7
MGP1603TX	8/9	MGP6304X	8/7	MIP99040	10/17	SEA9AN14FK	1/7
MGP1603X	8/7	MGP6304X5E	8/12	MIP99046	10/17	SEA9AN14PS	1/7
MGP1603X	8/11	MGP630NL	8/7	PRA15113	10/15	SEA9AN14S14	1/5
MGP1603XE2	8/12	MGP630NL	8/11	PRA15124	10/15	SEA9AN18	1/4
MGP1603XE2N	8/12	MGP8003B5	8/7	PRA15213	10/15	SEA9AN18C	1/7
MGP1603XN	8/12	MGP8003NA	8/7	PRA15224	10/15	SEA9AN18FK	1/7
MGP1604NAX	8/7	MGP8003NA	8/9	PRA15313	10/15	SEA9AN18PS	1/7
MGP1604TX	8/9	MGP8004B5	8/7	PRA15324	10/15	SEA9AN2	1/4
MGP1604X	8/7	MGP8004NA	8/7	PRA15413	10/15	SEA9AN26DS	1/5
MGP1604X	8/11	MGPBB25	8/11	PRA15424	10/15	SEA9AN27	1/4
MGP1604XE2	8/12	MGPBBP	8/18	PRA16113	10/15	SEA9AN27C	1/7
MGP1604XE2N	8/12	MGPC2025	8/15	PRA16124	10/15	SEA9AN2C	1/7
MGP1604XN	8/12	MGPC2050	8/15	PRA16213	10/15	SEA9AN2PS	1/7
MGP2003X	8/11	MGPC4025	8/15	PRA16224	10/15	SEA9AN510SL	1/4
MGP2003XN	8/12	MGPC4050	8/15	PRA16313	10/15	SEA9AN56SL	1/4
MGP2004X	8/11	MGPCH12	8/15	PRA16324	10/15	SEA9AN6	1/4
MGP2004XN	8/12	MGPCH12	10/11	PRA16413	10/15	SEA9AN616MS	1/4
MGP2503LL	8/7	MGPCH18	8/15	PRA16424	10/15	SEA9AN624MS	1/4
MGP2503NATX	8/9	MGPCH18	10/11	PRA20113	10/15	SEA9AN66DS	1/5
MGP2503NAX	8/7	MGPCH6	8/15	PRA20124	10/15	SEA9AN6C	1/7
MGP2503TX	8/9	MGPCH6	10/11	PRA20213	10/15	SEA9AN6FK	1/7

Product list

Reference	Page	Reference	Page	Reference	Page	Reference	Page
SEA9AN6PS	1/7	SEA9BN24SXP	10/13	SEA9BNDM250SD	1/12	SEA9NI2503	1/12
SEA9AN6S6	1/5	SEA9BN24SXS	1/13	SEA9BNEX034N	1/13	SEA9NI2504	1/12
SEA9AN96SL	1/4	SEA9BN24SXS	10/13	SEA9BNEXA15N	1/13	SEA9NI2504SM	1/9
SEA9BGPEXN	1/14	SEA9BN24TN	1/14	SEA9BNEXN	1/13	SEA9NKIT	1/7
SEA9BINCKIT	1/15	SEA9BN25012S8	1/8	SEA9BNKWH	1/8	SEA9NPB250TB	1/15
SEA9BL	1/7	SEA9BN25014S6	1/8	SEA9BNKWHP	1/8	SEA9NTB2504	1/12
SEA9BN100CCI	1/12	SEA9BN25016S4	1/8	SEA9BNMETE	1/8	SEA9PD	1/14
SEA9BN12	1/8	SEA9BN3110	1/8	SEA9BNSJKN	1/13	SEA9R11280	1/6
SEA9BN12512S8	1/8	SEA9BN3155	1/8	SEA9BNTJKA	1/13	SEA9R11291	1/6
SEA9BN12514S6	1/8	SEA9BN3210	1/8	SEA9BNTJKB	1/13	SEA9R11480	1/12
SEA9BN12516S4	1/8	SEA9BN3255	1/8	SEA9BNTJKN	1/13	SEA9R12263	1/6
SEA9BN1256S8	1/8	SEA9BN4	1/8	SEA9BNWL	1/13	SEA9R12280	1/6
SEA9BN12C	1/14	SEA9BN4C	1/14	SEA9BP	1/7	SEA9R12291	1/6
SEA9BN12E	1/14	SEA9BN4E	1/14	SEA9BP25	1/7	SEA9R12463	1/12
SEA9BN12HDGK	1/9	SEA9BN4P	1/14	SEA9BP5	1/7	SEA9R14280	1/6
SEA9BN12HDGR	1/9	SEA9BN4PEV	1/14	SEA9DE16	1/6	SEA9R14291	1/6
SEA9BN12M	1/8	SEA9BN4PS	1/14	SEA9DE16	10/12	SEA9R15280	1/6
SEA9BN12P	1/14	SEA9BN4SXP	1/13	SEA9DE24	1/6	SEA9R15291	1/6
SEA9BN12PEV	1/14	SEA9BN4SXP	10/13	SEA9DE24	10/12	SEA9R15463	1/12
SEA9BN12PS	1/14	SEA9BN4SXS	1/13	SEA9DE32	1/6	SEA9R15491	1/12
SEA9BN12SXP	1/13	SEA9BN4SXS	10/13	SEA9DE32	10/12	SEA9R41263	1/6
SEA9BN12SXP	10/13	SEA9BN4TN	1/14	SEA9DE40	1/6	SEA9R41463	1/12
SEA9BN12SXS	1/13	SEA9BN6	1/8	SEA9DE40	10/12	SEA9R44263	1/6
SEA9BN12SXS	10/13	SEA9BN6C	1/14	SEA9DE64	1/6	SEA9R44463	1/12
SEA9BN12TN	1/14	SEA9BN6E	1/14	SEA9DE64	10/12	SEA9TB1001	1/13
SEA9BN16	1/8	SEA9BN6HDGK	1/9	SEA9FCF	1/13	SEA9TB1252	1/6
SEA9BN16C	1/14	SEA9BN6HDGR	1/9	SEA9ISOKEY	1/13	SEA9TB1254	1/12
SEA9BN16E	1/14	SEA9BN6M	1/8	SEA9NA10	1/7	SEP0404M5	8/27
SEA9BN16HDGK	1/9	SEA9BN6P	1/14	SEA9NA14	1/7	SEP1004M5	8/27
SEA9BN16HDGR	1/9	SEA9BN6PEV	1/14	SEA9NA18	1/7	SEP1604M5	8/27
SEA9BN16M	1/8	SEA9BN6PS	1/14	SEA9NA27	1/7	SEP2504M5	8/27
SEA9BN16P	1/14	SEA9BN6TN	1/14	SEA9NA6	1/7	SEP4004M5	8/27
SEA9BN16PEV	1/14	SEA9BN8	1/8	SEA9NB12	1/13	SEP400M5M	8/27
SEA9BN16PS	1/14	SEA9BN8C	1/14	SEA9NB16	1/13	SEP6304M5	8/27
SEA9BN16SXP	1/13	SEA9BN8E	1/14	SEA9NB18	1/13	SEP630M5M	8/27
SEA9BN16SXP	10/13	SEA9BN8HDGK	1/9	SEA9NB24	1/13	SEPINTP1	8/27
SEA9BN16SXS	1/13	SEA9BN8HDGR	1/9	SEA9NB4	1/13	SEPINTPEGX	8/22
SEA9BN16SXS	10/13	SEA9BN8M	1/8	SEA9NB6	1/13	TRV00121	8/28
SEA9BN16TN	1/14	SEA9BN8P	1/14	SEA9NB8	1/13	TRV00210	8/28
SEA9BN18	1/8	SEA9BN8PEV	1/14	SEA9NCB1004	1/12	TRV00217	8/28
SEA9BN18C	1/14	SEA9BN8PS	1/14	SEA9NCB1604	1/12	TRV00810	8/28
SEA9BN18E	1/14	SEA9BN8SXP	1/13	SEA9NCB1604SM	1/9	TRV00820	8/28
SEA9BN18M	1/8	SEA9BN8SXP	10/13	SEA9NCB2004	1/12	TRV00870	8/28
SEA9BN18P	1/14	SEA9BN8SXS	1/13	SEA9NCB2004SM	1/9	TRV00880	8/28
SEA9BN18PEV	1/14	SEA9BN8SXS	10/13	SEA9NCB2504	1/12		
SEA9BN18PS	1/14	SEA9BN8TN	1/14	SEA9NCB2504SM	1/9		
SEA9BN18TN	1/14	SEA9BNBCE13	1/13	SEA9NDSI	1/12		
SEA9BN24	1/8	SEA9BNBCE25	1/13	SEA9NI1603	1/12		
SEA9BN24C	1/14	SEA9BNBCE7	1/13	SEA9NI1604	1/12		
SEA9BN24E	1/14	SEA9BNC	1/13	SEA9NI1604SM	1/9		
SEA9BN24M	1/8	SEA9BNDM160M	1/12	SEA9NI160RCCB	1/12		
SEA9BN24P	1/14	SEA9BNDM160SD	1/12	SEA9NI2003	1/12		
SEA9BN24PEV	1/14	SEA9BNDM200M	1/12	SEA9NI2004	1/12		
SEA9BN24PS	1/14	SEA9BNDM200SD	1/12	SEA9NI2004SM	1/9		
SEA9BN24SXP	1/13	SEA9BNDM250M	1/12	SEA9NI2254	1/12		



UK contact details -

0870 608 8 608

Fax 0870 608 8 606

Ireland contact details -

01 601 2200

Fax 01 601 2201

As the global specialist in energy management with operations in more than 100 countries, Schneider Electric offers integrated solutions across multiple market segments, including leadership positions in energy and infrastructure, industrial processes, building automation, and data centres/networks, as well as a broad presence in residential applications.

Schneider Electric is dedicated to making individuals' and organisations' energy safe, reliable, efficient, productive and green from Power Plant to Plug™.

We are changing our brand names and becoming one Schneider Electric. You'll get the same great quality products, but from one name you can remember and trust. This provides you and your customers with the reassurance associated with Schneider Electric.

Some of our market leading brands have already become Schneider Electric including **Merlin Gerin, Telemecanique, Square D, GET, Mita, Sarel, Himel, Thorsman, Tower** and **TAC**.

Working as one Schneider Electric makes it clearer that our ranges are highly compatible for integrated solutions.

Schneider Electric Ltd

United Kingdom
Stafford Park 5,
Telford
Shropshire
TF3 3BL
Tel: 0870 608 8 608
Fax: 0870 608 8 606
www.schneider-electric.com/uk

Ireland
Head office,
Block a
Maynooth Business Campus
Maynooth, Co. Kildare
Tel: (01) 601 2200
Fax: (01) 601 2201
www.schneider-electric.com/ie

Schneider Electric Limited is a company registered in England and Wales.
Registered number: 1407228. Registered office: Stafford Park 5, Telford, Shropshire TF3 3BL.

© 2013 Schneider Electric. All Rights Reserved. Schneider Electric, Active Energy Management, Compact, EcoStruxure, ION Enterprise, iRIO, Make the most of your energy, Masterpact, Micrologic, Power Plant To Plug, Modbus, and PowerLogic are owned by Schneider Electric Industries SAS, or its affiliated companies in the United States and other countries.

As standards, specifications and designs change from time to time, please ask for confirmation of the information given in this publication.

member of

