

Productinformatieblad

Specificaties

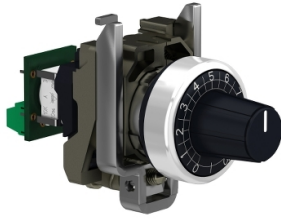

Harmony XB4, Complete potentiometer, Ø22mm

XB4BD912R100K

EAN Code: 3606480985034

Prijs: 76,35 EUR

Hoofd

range of product	Harmony XB4
product of component type	Potentiometer
device short name	XB4
koptype	Standaard
product presentatie	Compleet product

Complementair

kraag materiaal	Verchroomd metaal
bevestigingsdiameter	22,5 mm
compatibiliteit product	Ø 6 mm as
verkoop per ondeelbare hoeveelheid	1
CAD totale breedte	30 mm
CAD totale hoogte	47 mm
CAD totale diepte	82 mm
gewicht product	0,095 kg
beschermende behandeling	TH
ambient air temperature for storage	-40...70 °C
omgevingstemperatuur voor werking	-40...70 °C
beschermingsklasse tegen elektrische schokken	Klasse II In overeenstemming met IEC 60536
IP beschermingsgraad	IP66 In overeenstemming met IEC 60529 IP69 In overeenstemming met IEC 60529 IP69K In overeenstemming met IEC 60529
weerstand hoge druk drukring	7000000 Pa om 55 °C, afstand: 0.1 m
IK-beschermingsgraad	IK06 In overeenstemming met IEC 50102
standards	UL 508 CSA C22.2 Nr 14 IEC 60947-1
product certifications	UL listed CSA BV
vorm van kop signaleringseenheid	Rond
operator profiel	uitstekend knopje, met (wit)
Us nominale voedingsspanning	<= 30 V AC <= 42 V DC

De weergegeven prijs is de adviesprijs in euro excl. BTW. Deze kan onderhevig zijn aan korting. Neem contact op met uw lokale distributeur of detailhandel voor de daadwerkelijke prijs

nominaal vermogen in W	1 W om 70 °C
nauwkeurigheid interne conversieweerstand	+/-10%
kenmerken potentiometer	Lineair
mechanische duurzaamheid	50000 cycles
waarde in ohm	100000 Ohm
materiaal	Cermet
trilling bestendigheid	5 gn (f= 2...500 Hz) In overeenstemming met IEC 60068-2-6
schokbestendigheid	30 gn (duur = 18 ms) voor halve sinusgolf versnelling In overeenstemming met IEC 60068-2-27 50 gn (duur = 11 ms) voor halve sinusgolf versnelling In overeenstemming met IEC 60068-2-27
hoofdgroep	Potentiometer
productgroep	Potentiometer gekartelde knop
kleur van markering	Wit

Omgeving

Enclosure Type	UL type 4X/13
----------------	---------------

Verpakkingseenheid

Eenheidstype van verpakking 1	PCE
Aantal eenheden in verpakking 1	1
verpakking 1 hoogte	5,5 cm
verpakking 1 breedte	9,1 cm
verpakking 1 lengte	4,5 cm
verpakking_1_gewicht	106,0 g
Eenheidstype van verpakking 2	S02
Aantal eenheden in verpakking 2	40
verpakking 2 hoogte	15,0 cm
verpakking 2 breedte	30,0 cm
verpakking 2 lengte	40,0 cm
verpakking 2 gewicht	4,563 kg

contractuele waarborg

Garantie (in maanden)	18
-----------------------	----

Schneider Electric wil tegen 2050 de Net Zero-status hebben bereikt via partnerschappen in de toeleveringsketen, materialen met een lagere impact en circulariteit via onze doorlopende campagne "Use Better, Use Longer, Use Again" om de levensduur van producten en de recycleerbaarheid te verlengen.

[Uitleg van Environmental Data >](#)

[Hoe evalueren we de duurzaamheid van producten? >](#)

Milieuoetafdruk

Totale levenscyclus ecologische voetafdruk	2 kg CO2 eq.
Koolstofvoetafdruk van de fabricagefase [A1–A3]	1 kg CO2 eq.
Koolstofvoetafdruk van de distributiefase [A4]	0 kg CO2 eq.
Koolstofvoetafdruk van de installatiefase [A5]	0 kg CO2 eq.
Koolstofvoetafdruk van de gebruiksfase [B2, B3, B4, B6]	0.5 kg CO2 eq.
Koolstofvoetafdruk van de einde-levensfase [C1–C4]	0.2 kg CO2 eq.

Use Better

Materialen en verpakking

Gemiddeld percentage gerecycleerde kunststof	49 %
Gemiddeld percentage gerecycleerd metaal	19 %
Pakket met gerecycleerd karton	Ja
Verpakkingen zonder kunststof	Nee
SCIP-nummer	Dc4c5199-15ea-4d58-a3c3-6b64cfa69b65
RoHS-richtlijn van de EU	Conform door vrijstelling
REACH-verordening	Referentie bevat zorgwekkende stoffen (SVHC) boven drempelwaarde

Use Longer

Levensduurverlenging

Reparatie	Nee
Productreparatie-index	A

Use Again

Herverpakken en herfabriceren

Percentage mogelijke recycleerbaarheid	1
Circulair Profiel	Informatie over einde levensduur
Terugname	Ja
WEEE-label	 Het product moet op markten van de Europese Unie worden afgevoerd volgens specifieke afvalinzamelingsregels en mag nooit in een gewone vuilnisbak terechtkomen.

Productinformatieblad XB4BD912R100K

Dimensions Drawings

Dimensions

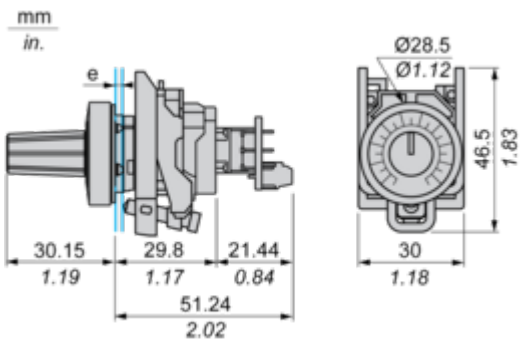

e: Panel thickness: 1 mm to 6 mm / 0.03 in. to 0.24 in

Productinformatieblad XB4BD912R100K

Mounting and Clearance

Panel Cut-out for Pushbuttons, Switches and Pilot Lights (Finished Holes, Ready for Installation)

Connection by Screw Terminals or Plug-in Connectors

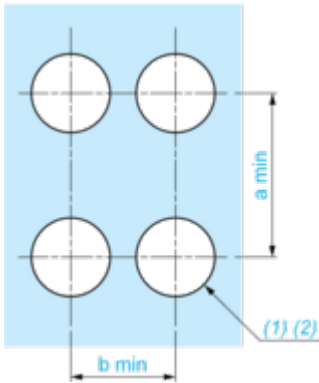

Connection by Faston Connectors

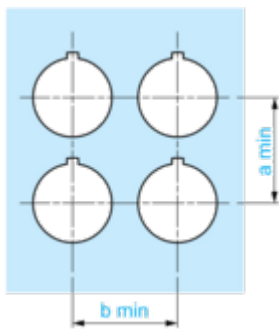

Connections	a in mm	a in in.	b in mm	b in in.
By screw clamp terminals or plug-in connector	40	1.57	30	1.18
By Faston connectors	45	1.77	32	1.26

Detail of Lug Recess

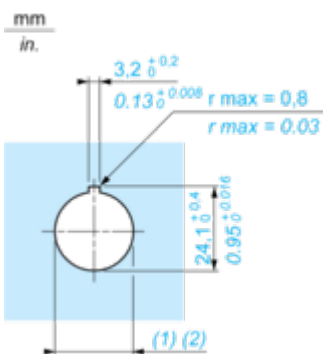

(1) Diameter on finished panel or support

(2) $\varnothing 22.5$ mm recommended ($\varnothing 22.3$ mm $^{+0.4}$) / $\varnothing 0.89$ in. recommended ($\varnothing 0.88$ in. $^{+0.016}$)

Productinformatieblad XB4BD912R100K

Technical Illustration

Dimensions

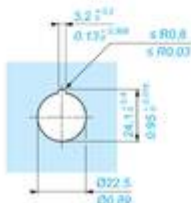
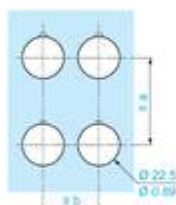
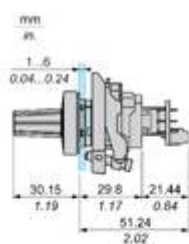

		a (mm)	a (in.)	b (mm)	b (in.)
		40	1.57	30	1.18
ZBE.....	ZBV.....				
		45	1.77	32	1.26
ZBE.....3	ZBV.....3				
		40	1.57	30	1.18
ZBE.....4	ZBV.....4				
		50	1.97	30	1.18
ZBE.....5	ZBV.....5				
		40	1.57	30	1.18
ZBE.....9	ZBV.....9				
		40	1.57	30	1.18
ZBRT	ZBRV1				



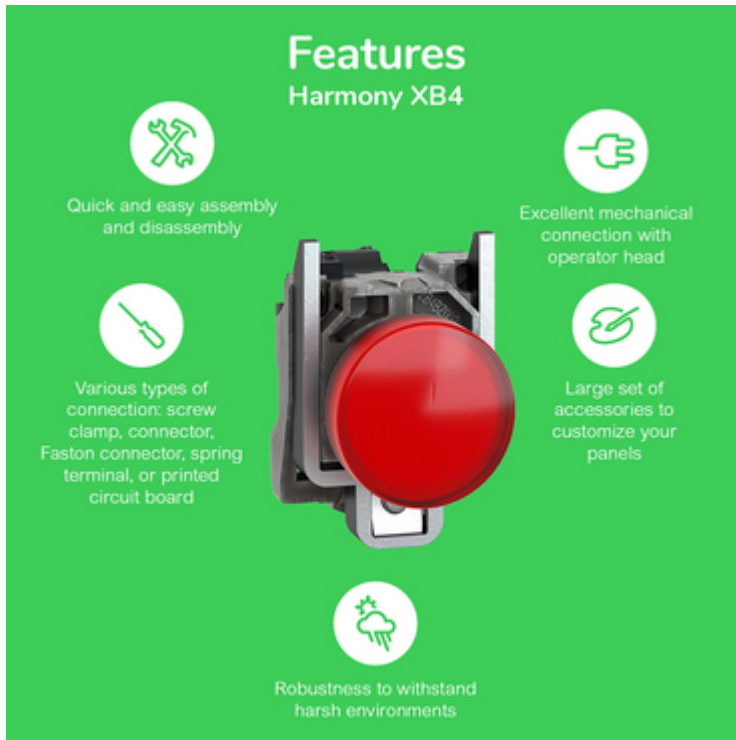

Offer Marketing Illustration

Product benefits / Features



The infographic features a central image of a red Schneider XB4 terminal block. Surrounding this central image are five circular icons, each with a corresponding text description of a feature. The background is a solid green color.

Features Harmony XB4

-  Quick and easy assembly and disassembly
-  Various types of connection: screw clamp, connector, Faston connector, spring terminal, or printed circuit board
-  Excellent mechanical connection with operator head
-  Large set of accessories to customize your panels
-  Robustness to withstand harsh environments

Offer Marketing Illustration

Product benefits / Features

Technical Benefits

Harmony XB4

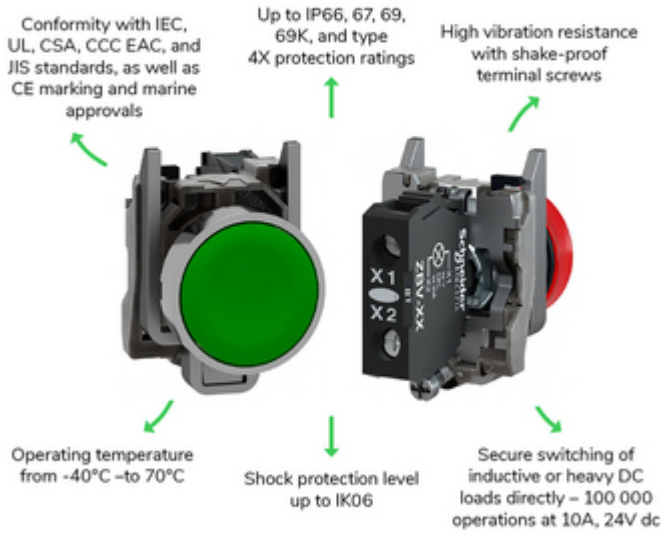

Image of product / Alternate images

Alternative

