

Data Sheet | Item Number: 2734-1105/327-9037

1-conductor female connector; lever; Push-in CAGE CLAMP®; 1.5 mm²; Pin spacing 3.5 mm; 5-pole; 100% protected against mismatching; direct marking; 1,50 mm²; light gray

<https://www.wago.com/2734-1105/327-9037>

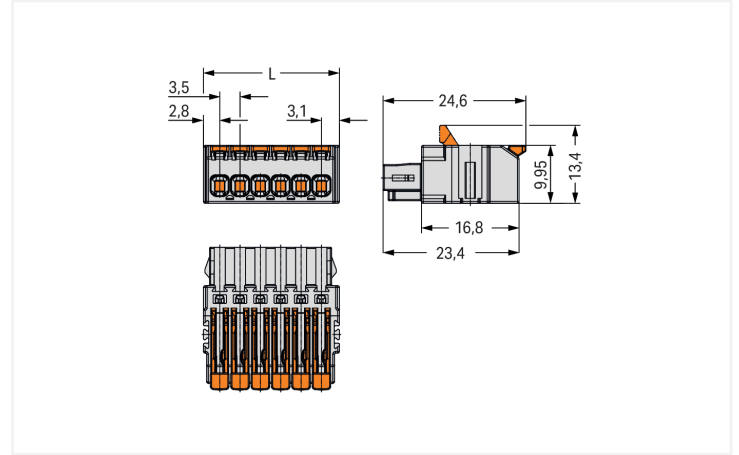

Color: ■ light gray

Similar to illustration

Dimensions in mm
 $L = (\text{pole no.} \times \text{pin spacing}) + 2.4 \text{ mm}$

Female connector, 2734 Series, lever

This female connector (item number 2734-1105/327-9037) simplifies electrical installations. Ensure that the strip lengths are between 9 and 10 mm when connecting conductors to this female connector. Featuring one conductor terminal along with Push-in CAGE CLAMP®, this connector is highly versatile. Push-in CAGE CLAMP® technology provides a universal connection solution for all conductor types. It allows both solid and fine-stranded conductors with ferrules to be inserted directly into the clamping point without the need for tools. Dimensions: (19.9 x 9.95 x 24.6) mm (width x height x depth). This female connector is suitable for conductor cross sections ranging from 0.14 mm² to 1.5 mm².

The contact surface is coated with tin.

Notes

Safety Information

The MCS – MULTI CONNECTION SYSTEM includes connectors without breaking capacity in accordance with DIN EN 61984. When used as intended, these connectors must not be connected/disconnected when live or under load. When used as intended, these connectors must not be connected/disconnected when live or under load. The circuit design should ensure header pins, which can be touched, are not live when unmated.

Variants:

Other pole numbers

Other versions (or variants) can be requested from WAGO Sales or configured at <https://configurator.wago.com/>.

Electrical data

Ratings per IEC/EN

Ratings per	IEC/EN 60664-1
Nominal voltage (III/3)	160 V
Rated impulse withstand voltage (III / 3)	2.5 kV
Rated voltage (III/2)	160 V
Rated impulse withstand voltage (III/2)	2.5 kV
Nominal voltage (II/2)	320 V
Rated impulse withstand voltage (II/2)	2.5 kV
Rated current	10 A

Ratings per IEC/EN

Legend (ratings)	(III / 2) ≙ Overvoltage category III / Pollution degree 2
------------------	---

Ratings per UL

Approvals per	UL 1059
Rated voltage UL (Use Group B)	300 V
Rated current UL (Use Group B)	10 A
Rated voltage UL (Use Group D)	300 V
Rated current UL (Use Group D)	10 A

Ratings per CSA

Approvals per	CSA
Rated voltage CSA (Use Group B)	300 V
Rated current CSA (Use Group B)	10 A
Rated voltage CSA (Use Group D)	300 V
Rated current CSA (Use Group D)	10 A

Connection Data

Clamping units	5
Total number of potentials	5
Number of connection types	1
Number of levels	1

Connection 1

Connection technology	Push-in CAGE CLAMP®
Actuation type	Lever
Solid conductor	0.14 ... 1.5 mm ² / 26 ... 14 AWG
Solid conductor; push-in termination	0.34 ... 1.5 mm ² / 22 ... 14 AWG
Fine-stranded conductor	0.14 ... 1.5 mm ² / 26 ... 14 AWG
Fine-stranded conductor; with insulated ferrule	0.14 ... 0.75 mm ²
Fine-stranded conductor; with uninsulated ferrule	0.14 ... 1 mm ²
Strip length	9 ... 10 mm / 0.35 ... 0.39 inches
Pole number	5
Conductor entry direction to mating direction	0°

Physical data

Pin spacing	3.5 mm / 0.138 inches
Width	19.9 mm / 0.783 inches
Height	9.95 mm / 0.392 inches
Depth	24.6 mm / 0.969 inches

Mechanical data

Variable coding	Yes
Marking type	Numbers
Anti-rotation protection	Yes

Plug-in connection

Contact type (pluggable connector)	Female connector/socket
Connector (connection type)	for conductor
Mismating protection	Yes

Material data

Note (material data)	Information on material specifications can be found here
Color	light gray
Material group	I
Insulation material (main housing)	Polyamide (PA66)
Flammability class per UL94	V0
Clamping spring material	Chrome-nickel spring steel (CrNi)
Contact material	Copper alloy
Contact Plating	Tin
Fire load	0.073 MJ
Weight	4.2 g

Environmental requirements

Limit temperature range	-60 ... +100 °C
Processing temperature	-35 ... +60 °C

Commercial data

PU (SPU)	100 pcs
Packaging type	Box
Country of origin	DE
GTIN	4066966416732
Customs tariff number	85366990990

Product Classification

UNSPSC	39121409
ETIM 9.0	EC002638
ETIM 10.0	EC002638
ECCN	NO US CLASSIFICATION

Environmental Product Compliance

RoHS Compliance Status	Compliant, No Exemption
------------------------	-------------------------

Downloads

Environmental Product Compliance

Compliance Search	
Environmental Product Compliance 2734-1105/327-9037	↓

Documentation

Additional Information			
Technical Section	03.04.2019	pdf 2027.26 KB	↓

1 Compatible Products

1.1 System counterpart

1.1.1 Male connector/plug

<p>Item No.: 734-305 1-conductor male connector; CAGE CLAMP®; 1.5 mm²; Pin spacing 3.5 mm; 5-pole; 100% protected against mismatching; 1,50 mm²; light gray</p>	<p>Item No.: 734-165 THT male header; 1.0 x 1.0 mm solder pin; angled; 100% protected against mismatching; Pin spacing 3.5 mm; 5-pole; light gray</p>	<p>Item No.: 734-135 THT male header; 1.0 x 1.0 mm solder pin; straight; 100% protected against mismatching; Pin spacing 3.5 mm; 5-pole; light gray</p>

1.2 Optional Accessories

1.2.1 Coding

1.2.1.1 Coding



Item No.: 2734-505

Coding pin carrier; 5 coding keys; for female connectors; orange

1.2.2 Ferrule

1.2.2.1 Ferrule



Item No.: 216-241

Ferrule; Sleeve for 0.5 mm² / 20 AWG; insulated; electro-tin plated; electrolytic copper; gastight crimped; acc. to DIN 46228, Part 4/09.90; white



Item No.: 216-141

Ferrule; Sleeve for 0.5 mm² / 20 AWG; un-insulated; electro-tin plated; electrolytic copper; gastight crimped; acc. to DIN 46228, Part 1/08.92



Item No.: 216-242

Ferrule; Sleeve for 0.75 mm² / 18 AWG; insulated; electro-tin plated; electrolytic copper; gastight crimped; acc. to DIN 46228, Part 4/09.90; gray



Item No.: 216-262

Ferrule; Sleeve for 0.75 mm² / 18 AWG; insulated; electro-tin plated; electrolytic copper; gastight crimped; acc. to DIN 46228, Part 4/09.90; gray



Item No.: 216-142

Ferrule; Sleeve for 0.75 mm² / 18 AWG; un-insulated; electro-tin plated; electrolytic copper; gastight crimped; acc. to DIN 46228, Part 1/08.92

1.2.3 Jumper

1.2.3.1 Jumper



Item No.: 2734-402

Jumper; for conductor entry; 2-way; insulated; light gray

1.2.4 Locking system

1.2.4.1 Locking system



Item No.: 2734-516

center locking; for female connectors; For Push-in CAGE CLAMP® connection; lever; Pin spacing 3.5 mm; 4-pole; orange



Item No.: 2734-510

Locking lever; for female connectors; 1 part; For Push-in CAGE CLAMP® connection; lever; orange

1.2.5 Strain relief

1.2.5.1 Strain relief plate



Item No.: 2734-534

Strain relief plate; for female connectors; 13 mm wide; 1 part; lever; Pin spacing 3.5 mm; light gray

1.2.6 Test and measurement

1.2.6.1 Testing accessories



Item No.: 735-500

WAGO Test pin; 1 mm Ø; 30 V AC / 60 V DC; CAT0; 1 A; 6 mm uninsulated; Test lead for soldering up to 0,5mm²

Installation Notes

Conductor termination

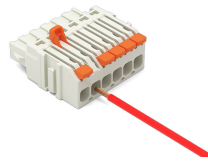
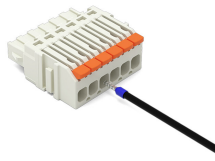
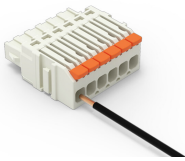

Conductor removal

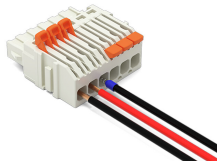

Testing

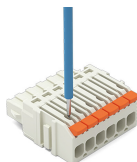
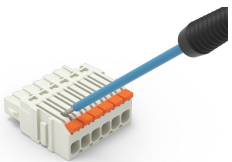

Marking

