

**Data Sheet | Item Number: 2734-1104/328-000/334-000**

1-conductor female connector; lever; Push-in CAGE CLAMP®; 1.5 mm<sup>2</sup>; Pin spacing 3.5 mm; 4-pole; 100% protected against mismatching; Centered locking levers; Strain relief plate; 1,50 mm<sup>2</sup>; light gray



<https://www.wago.com/2734-1104/328-000/334-000>



Color: ■ light gray

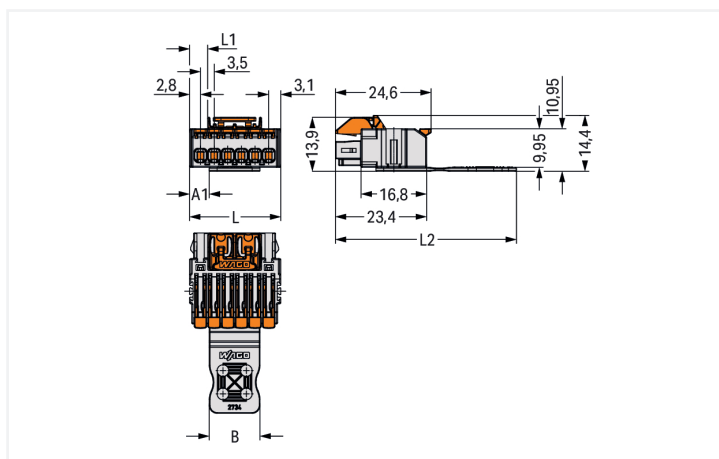

Dimensions in mm

Pole No.	A1	B	L	L1	L2
4	1.55	13	16.4	1.15	46.4
5	5.05	13	19.9	4.65	46.4
6	5.05	13	23.4	4.65	46.4
7	8.55	13	26.9	8.15	46.4
8	1.55	27	30.4	8.15	49.4
10	5.05	27	37.4	11.65	49.4
12	1.55	41	44.4	15.15	54.4
16	8.55	41	58.4	22.15	54.4

Dimensions in mm

Female connector, 2734 Series, 0° conductor exit to connection direction

This female connector (item number 2734-1104/328-000/334-000) simplifies electrical installations. Ensure that the strip lengths are between 9 and 10 mm when connecting conductors to this female connector. Featuring one conductor terminal along with Push-in CAGE CLAMP®, this product outperforms the competition. Push-in CAGE CLAMP® connection technology is ideal for connecting all conductor types. Solid and fine-stranded conductors with ferrules can be inserted without the need for tools—all thanks to its pluggable design. The item's dimensions are (16.4 x 14.4 x 46.4) mm (width x height x depth). Depending on the conductor type, this female connector is designed for conductor cross sections ranging from 0.14 mm<sup>2</sup> to 1.5 mm<sup>2</sup>.

The contact surface is coated with tin. You can secure connected conductors using the strain relief plate to make cables more manageable..

## Notes

### Safety Information

The MCS – MULTI CONNECTION SYSTEM includes connectors without breaking capacity in accordance with DIN EN 61984. When used as intended, these connectors must not be connected/disconnected when live or under load. When used as intended, these connectors must not be connected/disconnected when live or under load. The circuit design should ensure header pins, which can be touched, are not live when unmated.

### Variants:

Other pole numbers

Other versions (or variants) can be requested from WAGO Sales or configured at <https://configurator.wago.com/>.

## Electrical data

### Ratings per IEC/EN

Ratings per	IEC/EN 60664-1
Nominal voltage (III/3)	160 V
Rated impulse withstand voltage (III / 3)	2.5 kV
Rated voltage (III/2)	160 V
Rated impulse withstand voltage (III/2)	2.5 kV
Nominal voltage (II/2)	320 V
Rated impulse withstand voltage (II/2)	2.5 kV
Rated current	10 A
Legend (ratings)	(III / 2) ≙ Overvoltage category III / Pollution degree 2

### Ratings per UL

Approvals per	UL 1059
Rated voltage UL (Use Group B)	300 V
Rated current UL (Use Group B)	10 A
Rated voltage UL (Use Group D)	300 V
Rated current UL (Use Group D)	10 A

### Ratings per CSA

Approvals per	CSA
Rated voltage CSA (Use Group B)	300 V
Rated current CSA (Use Group B)	10 A
Rated voltage CSA (Use Group D)	300 V
Rated current CSA (Use Group D)	10 A

## Connection Data

Clamping units	4
Total number of potentials	4
Number of connection types	1

## Connection 1

Connection technology	Push-in CAGE CLAMP®
Actuation type	Lever
Solid conductor	0.14 ... 1.5 mm <sup>2</sup> / 26 ... 14 AWG
Solid conductor; push-in termination	0.34 ... 1.5 mm <sup>2</sup> / 22 ... 14 AWG
Fine-stranded conductor	0.14 ... 1.5 mm <sup>2</sup> / 26 ... 14 AWG
Fine-stranded conductor; with insulated ferrule	0.14 ... 0.75 mm <sup>2</sup>
Fine-stranded conductor; with uninsulated ferrule	0.14 ... 1 mm <sup>2</sup>
Strip length	9 ... 10 mm / 0.35 ... 0.39 inches
Pole number	4
Conductor entry direction to mating direction	0°

## Physical data

Pin spacing	3.5 mm / 0.138 inches
Width	16.4 mm / 0.646 inches
Height	14.4 mm / 0.567 inches
Depth	46.4 mm / 1.827 inches

## Mechanical data

Variable coding	Yes
Anti-rotation protection	Yes

## Plug-in connection

Contact type (pluggable connector)	Female connector/socket
Connector (connection type)	for conductor
Mismating protection	Yes
Locking of plug-in connection	Center locking lever
Strain relief	Strain relief plate

## Material data

Note (material data)	<a href="#">Information on material specifications can be found here</a>
Color	light gray
Material group	I
Insulation material (main housing)	Polyamide (PA66)
Flammability class per UL94	V0
Clamping spring material	Chrome-nickel spring steel (CrNi)
Contact material	Copper alloy
Contact Plating	Tin
Fire load	0.081 MJ
Weight	4.1 g

**Environmental requirements**

Limit temperature range	-60 ... +100 °C
Processing temperature	-35 ... +60 °C

**Commercial data**

PU (SPU)	50 pcs
Packaging type	Box
Country of origin	DE
GTIN	4066966387599
Customs tariff number	85366990990

**Product Classification**

UNSPSC	39121409
ETIM 9.0	EC002638
ETIM 10.0	EC002638
ECCN	NO US CLASSIFICATION

**Environmental Product Compliance**

RoHS Compliance Status	Compliant, No Exemption
------------------------	-------------------------

**Downloads**

**Environmental Product Compliance**

Compliance Search	<a href="#">↓</a>
-------------------	-------------------

**Documentation**

<b>Additional Information</b>			
Technical Section	03.04.2019	pdf 2027.26 KB	<a href="#">↓</a>

**CAD/CAE-Data**

CAD data	<a href="#">↓</a>
----------	-------------------

PCB Design	<a href="#">↓</a>
	<a href="#">↓</a>

## 1 Compatible Products

### 1.1 System counterpart

#### 1.1.1 Male connector/plug

**Item No.: 734-304**

1-conductor male connector; CAGE CLAMP®; 1.5 mm<sup>2</sup>; Pin spacing 3.5 mm; 4-pole; 100% protected against mismatching; 1,50 mm<sup>2</sup>; light gray

**Item No.: 734-164**

THT male header; 1.0 x 1.0 mm solder pin; angled; 100% protected against mismatching; Pin spacing 3.5 mm; 4-pole; light gray

**Item No.: 734-134**

THT male header; 1.0 x 1.0 mm solder pin; straight; 100% protected against mismatching; Pin spacing 3.5 mm; 4-pole; light gray

## 1.2 Optional Accessories

### 1.2.1 Coding

#### 1.2.1.1 Coding



**Item No.: 2734-505**

Coding pin carrier; 5 coding keys; for female connectors; orange

### 1.2.2 Ferrule

#### 1.2.2.1 Ferrule



**Item No.: 216-241**

Ferrule; Sleeve for 0.5 mm<sup>2</sup> / 20 AWG; insulated; electro-tin plated; electrolytic copper; gastight crimped; acc. to DIN 46228, Part 4/09.90; white



**Item No.: 216-141**

Ferrule; Sleeve for 0.5 mm<sup>2</sup> / 20 AWG; un-insulated; electro-tin plated; electrolytic copper; gastight crimped; acc. to DIN 46228, Part 1/08.92



**Item No.: 216-242**

Ferrule; Sleeve for 0.75 mm<sup>2</sup> / 18 AWG; insulated; electro-tin plated; electrolytic copper; gastight crimped; acc. to DIN 46228, Part 4/09.90; gray



**Item No.: 216-262**

Ferrule; Sleeve for 0.75 mm<sup>2</sup> / 18 AWG; insulated; electro-tin plated; electrolytic copper; gastight crimped; acc. to DIN 46228, Part 4/09.90; gray



**Item No.: 216-142**

Ferrule; Sleeve for 0.75 mm<sup>2</sup> / 18 AWG; un-insulated; electro-tin plated; electrolytic copper; gastight crimped; acc. to DIN 46228, Part 1/08.92

### 1.2.3 Jumper

#### 1.2.3.1 Jumper



**Item No.: 2734-402**

Jumper; for conductor entry; 2-way; insulated; light gray

## 1.2.4 Test and measurement

### 1.2.4.1 Testing accessories



**Item No.: 735-500**

WAGO Test pin; 1 mm Ø; 30 V AC / 60 V DC; CAT0; 1 A; 6 mm uninsulated; Test lead for soldering up to 0,5mm<sup>2</sup>

## Installation Notes

### Conductor termination

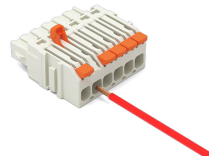
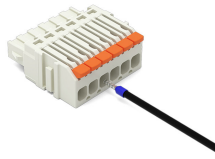
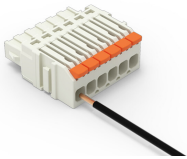

### Conductor removal

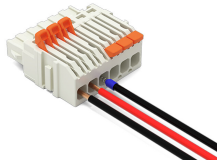

### Testing

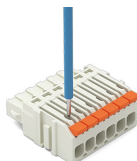
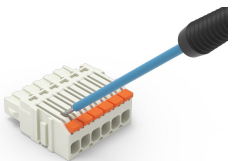

### Marking

